

Dell PowerConnect W-Series

ArubaOS 6.2

User Guide



Copyright Information

© 2013 Aruba Networks, Inc. Aruba Networks trademarks include  airwave, Aruba Networks®, Aruba Wireless Networks®, the registered Aruba the Mobile Edge Company logo, and Aruba Mobility Management System®. Dell™, the DELL™ logo, and PowerConnect™ are trademarks of Dell Inc.

All rights reserved. Specifications in this manual are subject to change without notice.

Originated in the USA. All other trademarks are the property of their respective owners.

Open Source Code

Certain Aruba products include Open Source software code developed by third parties, including software code subject to the GNU General Public License (GPL), GNU Lesser General Public License (LGPL), or other Open Source Licenses. Includes software from Litech Systems Design. The IF-MAP client library copyright 2011 Infoblox, Inc. All rights reserved. This product includes software developed by Lars Fenneberg, et al. The Open Source code used can be found at this site:

http://www.arubanetworks.com/open_source

Legal Notice

The use of Aruba Networks, Inc. switching platforms and software, by all individuals or corporations, to terminate other vendors' VPN client devices constitutes complete acceptance of liability by that individual or corporation for this action and indemnifies, in full, Aruba Networks, Inc. from any and all legal actions that might be taken against it with respect to infringement of copyright on behalf of those vendors

Contents

Copyright Information	2
Open Source Code	2
Legal Notice	2
Contents	3
About this Guide	61
What's New In ArubaOS 6.2	61
Fundamentals	63
WebUI	63
CLI	63
Related Documents	64
Conventions	64
The Basic User-Centric Networks	66
Understanding Basic Deployment and Configuration Tasks	66
Deployment Scenario #1: Controller and APs on Same Subnet	66
Deployment Scenario #2: APs All on One Subnet Different from Controller Subnet	67
Deployment Scenario #3: APs on Multiple Different Subnets from Controllers	68
Configuring the Controller	69
Running Initial Setup	69
Connecting to the Controller after Initial Setup	70
Dell W-7200 Series Controller	70
New Port Numbering Scheme	70
Individual Port Behavior	70
Using the LCD Screen	70
Using the LCD and USB Drive	72
Upgrading an Image	72
Uploading a Pre-saved Configuration	72
Disabling LCD Menu Functions	73

Configuring a VLAN to Connect to the Network	73
Creating, Updating, and Viewing VLANs and Associated IDs	74
Creating, Updating, and Deleting VLAN Pools	74
Assigning and Configuring the Trunk Port	74
In the WebUI	75
In the CLI	75
Configuring the Default Gateway	75
In the WebUI	75
In the CLI	75
Configuring the Loopback IP Address for the Controller	75
In the WebUI	76
In the CLI	76
Configuring the System Clock	76
Installing Licenses	77
Connecting the Controller to the Network	77
Enabling Wireless Connectivity	77
Configuring Your User-Centric Network	77
Control Plane Security	79
Control Plane Security Overview	80
Configuring Control Plane Security	80
In the WebUI	80
In the CLI	81
Managing AP Whitelists	82
Adding APs to the Campus and Remote AP Whitelists	82
Viewing Whitelist Status	83
Modifying an AP in the Campus AP Whitelist	85
Revoking an AP via the Campus AP Whitelist	86
Deleting an AP Entry from the Campus AP Whitelist	86
Purging the Campus AP Whitelist	86
Managing Whitelists on Master and Local Controllers	87
Campus AP Whitelist Synchronization	88
Viewing and Managing the Master or Local Switch Whitelists	88

Viewing the Master or Local Switch Whitelist	88
Deleting an Entry from the Master or Local Switch Whitelist	89
Purging the Master or Local Switch Whitelist	90
Working in Environments with Multiple Master Controllers	90
Configuring Networks with a Backup Master Controller	90
Configuring Networks with Clusters of Master Controllers	90
Creating a Cluster Root	91
Creating a Cluster Member	92
Viewing Controller Cluster Settings	92
Replacing a Controller on a Multi-Controller Network	93
Replacing Controllers in a Single Master Network	93
Replacing a Local Controller	93
Replacing a Master Controller with No Backup	94
Replacing a Redundant Master Controller	94
Replacing Controllers in a Multi-Master Network	95
Replacing a Local Controller in a Multi-Master Network	95
Replacing a Cluster Member Controller with no Backup	95
Replacing a Redundant Cluster Member Controller	95
Replacing a Cluster Root Controller with no Backup Controller	96
Replacing a Redundant Cluster Root Controller	96
Configuring Control Plane Security after Upgrading	97
Troubleshooting Control Plane Security	97
Identifying Certificate Problems	97
Verifying Certificates	98
Disabling Control Plane Security	98
Verifying Whitelist Synchronization	98
Supported APs	99
Rogue APs	99
Software Licenses	100
Understanding License Terminology	100
Working with Licenses	101
Working with Licenses on a Multiple Controller Network	102

Using Licenses	102
Understanding License Interaction	103
License Installation Best Practices and Exceptions	104
Installing a License	104
Enabling a new license on your controller	104
Requesting a Software License in Email	105
Locating the System Serial Number	105
Obtaining a Software License Key	105
Creating a Software License Key	105
Applying the Software License Key in the WebUI	106
Applying the Software License Key in the License Wizard	106
Deleting a License	106
Moving Licenses	106
Resetting the Controller	106
Network Configuration Parameters	108
Configuring VLANs	108
Creating and Updating VLANs	108
In the WebUI	108
In the CLI	109
Creating Bulk VLANs In the WebUI	109
In the CLI	109
Creating Named VLANs	109
Creating a Named VLAN not in a Pool	109
In the WebUI	109
In the CLI	110
Creating a VLAN Pool	110
Using the WebUI	110
Distinguishing Between Even and Hash Assignment Types	111
Updating a VLAN Pool	112
Deleting a VLAN Pool	112
Creating a VLAN Pool Using the CLI	112
Viewing and Adding VLAN IDs Using the CLI	112

Adding a Bandwidth Contract to the VLAN	113
Optimizing VLAN Broadcast and Multicast Traffic	113
Using the CLI	114
Using the WebUI	114
Configuring Ports	114
Classifying Traffic as Trusted or Untrusted	115
About Trusted and Untrusted Physical Ports	115
About Trusted and Untrusted VLANs	115
Configuring Trusted/Untrusted Ports and VLANs	115
In the WebUI	115
In the CLI	116
Configuring Trusted and Untrusted Ports and VLANs in Trunk Mode	116
In the WebUI	116
In the CLI	117
Understanding VLAN Assignments	117
How a VLAN Obtains an IP Address	117
Assigning a Static Address to a VLAN	117
In the WebUI	118
In the CLI	118
Configuring a VLAN to Receive a Dynamic Address	118
Configuring Multiple Wired Uplink Interfaces (Active-Standby)	118
Enabling the DHCP Client	118
In the WebUI	118
In the CLI	119
Enabling the PPPoE Client	119
In the WebUI	119
In the CLI	120
Default Gateway from DHCP/PPPoE	120
In the WebUI	120
In the CLI	120
Configuring DNS/WINS Server from DHCP/PPPoE	120
In the WebUI	120

In the CLI	120
Configuring Source NAT to Dynamic VLAN Address	121
In the WebUI	121
In the CLI	121
Configuring Source NAT for VLAN Interfaces	121
Example Configuration	122
In the WebUI	122
In the CLI	122
Inter-VLAN Routing	122
Using the WebUI to restrict VLAN routing	123
Using the CLI	123
Configuring Static Routes	123
In the WebUI	123
In the CLI	124
Configuring the Loopback IP Address	124
In the WebUI	124
In the CLI	124
Configuring the Controller IP Address	125
Using the CLI	125
Configuring GRE Tunnels	125
Creating a Tunnel Interface	126
In the WebUI	126
In the CLI	126
Directing Traffic into the Tunnel	126
Static Routes	126
Firewall Policy	126
In the WebUI	127
In the CLI	127
Tunnel Keepalives	127
In the WebUI	127
In the CLI	127
IPv6 Support	128

Understanding IPv6 Notation	128
Understanding IPv6 Topology	128
Enabling IPv6	129
Enabling IPv6 Support for Controller and APs	129
Configuring IPv6 Addresses	131
In the WebUI	131
To Configure Link Local Address	131
To Configure Global Unicast Address	131
To Configure Loopback Interface Address	132
In the CLI	132
Configuring IPv6 Static Neighbors	132
In the WebUI	132
In the CLI	132
Configuring IPv6 Default Gateway and Static IPv6 Routes	133
In the WebUI	133
To Configure IPv6 Default Gateway	133
To Configure Static IPv6 Routes	133
In the CLI	133
Managing Controller IP Addresses	133
In the WebUI	133
In the CLI	133
Configuring Multicast Listener Discovery (MLD)	134
In the WebUI	134
To Modify IPv6 MLD Parameters	134
In the CLI	134
Debugging an IPv6 Controller	135
In the WebUI	135
In the CLI	135
Provisioning an IPv6 AP	135
In the WebUI	135
In the CLI	135
Filtering an IPv6 Extension Header (EH)	136

Configuring a Captive Portal over IPv6	136
Working with IPv6 Router Advertisements (RAs)	136
Configuring an IPv6 RA on a VLAN	137
Using WebUI	137
Using CLI	138
Configuring Optional Parameters for RAs	138
In the WebUI	139
In the CLI	139
Viewing IPv6 RA Status	140
Understanding ArubaOS Supported Network Configuration for IPv6 Clients	140
Supported Network Configuration	140
Understanding the Network Connection Sequence for Windows IPv6 Clients	141
Understanding ArubaOS Authentication and Firewall Features that Support IPv6	141
Understanding Authentication	141
Working with Firewall Features	142
Understanding Firewall Policies	143
Creating an IPv6 Firewall Policy	145
Assigning an IPv6 Policy to a User Role	145
Understanding DHCPv6 Passthrough/Relay	146
Managing IPv6 User Addresses	146
Viewing or Deleting User Entries	146
Understanding User Roles	146
Viewing Datapath Statistics for IPv6 Sessions	146
Understanding IPv6 Exceptions and Best Practices	146
Link Aggregation Control Protocol (LACP)	148
Understanding LACP Best Practices and Exceptions	148
Configuring LACP	149
In the CLI	149
In the WebUI	150
LACP Sample Configuration	150
OSPFv2	152
Understanding OSPF Deployment Best Practices and Exceptions	152

Understanding OSPFv2 by Example using a WLAN Scenario	153
WLAN Topology	153
WLAN Routing Table	153
Understanding OSPFv2 by Example using a Branch Office Scenario	154
Branch Office Topology	154
Branch Office Routing Table	155
Configuring OSPF	155
Sample Topology and Configuration	157
Remote Branch 1	157
Remote Branch 2	158
W-3200 Central Office Controller—Active	159
W-3200 Central Office Controller—Backup	160
Tunneled Nodes	163
Understanding Tunneled Node Configuration	163
Configuring a Wired Tunneled Node Client	164
Configuring an Access Port as a Tunneled Node Port	165
Configuring a Trunk Port as a Tunneled Node Port	165
Sample Output	166
Authentication Servers	168
Understanding Authentication Server Best Practices and Exceptions	168
Understanding Servers and Server Groups	168
Configuring Servers	169
Configuring a RADIUS Server	169
Using the WebUI	170
Using the CLI	170
RADIUS Server Authentication Codes	171
RADIUS Server Fully Qualified Domain Names	171
Set a DNS Query Interval	171
Using the WebUI	171
Using the CLI	171
Configuring an RFC-3576 RADIUS Server	171
Using the WebUI	172

Using the CLI	172
Configuring an LDAP Server	172
Using the WebUI	173
Using the CLI	173
Configuring a TACACS+ Server	173
Using the WebUI	174
Using the CLI	174
Configuring a Windows Server	174
Using the WebUI	175
Using the CLI	175
Managing the Internal Database	175
Configuring the Internal Database	175
Using the WebUI	176
Using the CLI	176
Managing Internal Database Files	176
Exporting Files in the WebUI	176
Importing Files in the WebUI	177
Exporting and Importing Files in the CLI	177
Working with Internal Database Utilities	177
Deleting All Users	177
Repairing the Internal Database	177
Configuring Server Groups	177
Configuring Server Groups	178
Using the WebUI	178
Using the CLI	178
Configuring Server List Order and Fail-Through	178
Using the WebUI	179
Using the CLI	179
Configuring Dynamic Server Selection	179
Using the WebUI	180
Using the CLI	181
Configuring Match FQDN Option	181

Using the WebUI	181
Using the CLI	181
Trimming Domain Information from Requests	181
Using the WebUI	181
Using the CLI	182
Configuring Server-Derivation Rules	182
Using the WebUI	183
Using the CLI	183
Configuring a Role Derivation Rule for the Internal Database	183
Using the WebUI	183
Using the CLI	184
Assigning Server Groups	184
User Authentication	184
Management Authentication	184
Using the WebUI	184
Using the CLI	184
Accounting	185
RADIUS Accounting	185
Using the WebUI	186
Using the CLI	187
TACACS+ Accounting	187
Configuring Authentication Timers	187
Setting an Authentication Timer	188
Using the WebUI	188
Using the CLI	188
MAC-based Authentication	189
Configuring MAC-Based Authentication	189
Configuring the MAC Authentication Profile	189
Using the WebUI to configure a MAC authentication profile	190
Using the CLI to configure a MAC authentication profile	190
Configuring Clients	190
In the WebUI	190

In the CLI	191
802.1X Authentication	192
Understanding 802.1X Authentication	192
Supported EAP Types	193
Configuring Authentication with a RADIUS Server	193
Configuring Authentication Terminated on Controller	194
Configuring 802.1X Authentication	195
In the WebUI	195
In the CLI	199
Configuring and Using Certificates with AAA FastConnect	200
In the WebUI	200
In the CLI	200
Configuring User and Machine Authentication	201
Working with Role Assignment with Machine Authentication Enabled	201
Enabling 802.1x Supplicant Support on an AP	202
Prerequisites	203
Provisioning an AP as a 802.1X Supplicant	203
In the WebUI	203
In the CLI	203
Sample Configurations	204
Configuring Authentication with an 802.1X RADIUS Server	204
Configuring Roles and Policies	204
Creating the Student Role and Policy	204
In the WebUI	205
In the CLI	205
Creating the Faculty Role and Policy	206
Using the WebUI	206
In the CLI	206
Creating the Guest Role and Policy	206
In the WebUI	206
In the CLI	207
Creating Roles and Policies for Sysadmin and Computer	208

In the WebUI	208
In the CLI	208
Using the WebUI to create the computer role	208
Creating an Alias for the Internal Network Using the CLI	208
Configuring the RADIUS Authentication Server	208
In the WebUI	209
In the CLI	209
Configuring 802.1X Authentication	209
In the WebUI	209
In the CLI	210
Configuring VLANs	210
In the WebUI	210
In the CLI	211
Configuring the WLANs	211
Configuring the Guest WLAN	211
In the WebUI	211
In the CLI	212
Configuring the Non-Guest WLANs	212
In the WebUI	212
In the CLI	213
Configuring Authentication with the Controller's Internal Database	214
Configuring the Internal Database	214
In the WebUI	214
In the CLI	214
Configuring a Server Rule Using the WebUI	214
Configuring a Server Rule Using the CLI	214
Configuring 802.1x Authentication	215
In the WebUI	215
In the CLI	215
Configuring VLANs	215
In the WebUI	216
In the CLI	216

Configuring WLANs	216
Configuring the Guest WLAN	217
In the WebUI	217
In the CLI	217
Configuring the Non-Guest WLANs	218
In the WebUI	218
In the CLI	219
Configuring Mixed Authentication Modes	219
In the CLI	219
Performing Advanced Configuration Options for 802.1X	220
Configuring Reauthentication with Unicast Key Rotation	220
In the WebUI	220
In the CLI	220
Stateful and WISPr Authentication	221
Working With Stateful Authentication	221
Working With WISPr Authentication	222
Understanding Stateful Authentication Best Practices	222
Configuring Stateful 802.1x Authentication	222
In the WebUI	223
In the CLI	223
Configuring Stateful NTLM Authentication	223
In the WebUI	223
In the CLI	224
Configuring Stateful Kerberos Authentication	224
In the WebUI	224
In the CLI	225
Configuring WISPr Authentication	225
In the WebUI	225
In the CLI	226
Certificate Revocation	228
Understanding OCSP and CRL	228
Configuring a Controller as OCSP and CRL Clients	228

Configuring an OCSP Controller as a Responder	228
Configuring the Controller as an OCSP Client	229
In the WebUI	229
In the CLI	230
Configuring the Controller as a CRL Client	230
In the WebUI	231
In the CLI	231
Configuring the Controller as an OCSP Responder	231
In the WebUI	231
In the CLI	232
Captive Portal Authentication	233
Understanding Captive Portal	233
Policy Enforcement Firewall Next Generation (PEFNG) License	234
Controller Server Certificate	234
Configuring Captive Portal in the Base Operating System	234
In the WebUI	235
In the CLI	236
Using Captive Portal with a PEFNG License	237
Configuring Captive Portal in the WebUI	238
Configuring Captive Portal in the CLI	239
Sample Authentication with Captive Portal	239
Creating a Guest User Role	239
Creating an Auth-guest User Role	240
Configuring Policies and Roles in the WebUI	240
Creating a Time Range	240
Creating Aliases	241
Creating an Auth-Guest-Access Policy	241
Creating an Block-Internal-Access Policy	242
Creating a Drop-and-Log Policy	243
Creating a Guest Role	243
Creating an Auth-Guest Role	244
Configuring Policies and Roles in the CLI	244

Defining a Time Range	244
Creating Aliases	244
Creating a Guest-Logon-Access Policy	245
Creating an Auth-Guest-Access Policy	245
Creating a Block-Internal-Access Policy	245
Creating a Drop-and-Log Policy	245
Creating a Guest-Logon Role	245
Creating an Auth-Guest Role	245
Configuring Guest VLANs	245
In the WebUI	246
In the CLI	246
Configuring Captive Portal Authentication Profiles	246
Modifying the Initial User Role	247
Configuring the AAA Profile	247
Configuring the WLAN	248
Managing User Accounts	248
Configuring Captive Portal Configuration Parameters	249
Enabling Optional Captive Portal Configurations	250
Uploading Captive Portal Pages by SSID Association	251
Changing the Protocol to HTTP	251
Configuring Redirection to a Proxy Server	252
Redirecting Clients on Different VLANs	253
Web Client Configuration with Proxy Script	254
Personalizing the Captive Portal Page	254
Creating and Installing an Internal Captive Portal	256
Creating a New Internal Web Page	256
Username Example	257
Password Example	257
FQDN Example	257
Basic HTML Example	258
Installing a New Captive Portal Page	258
Displaying Authentication Error Messages	258

Reverting to the Default Captive Portal	259
Configuring Localization	259
Customizing the Welcome Page	262
Customizing the Pop-Up box	263
Customizing the Logged Out Box	264
Creating Walled Garden Access	265
In the WebUI	265
In the CLI	266
Enabling Captive Portal Enhancements	266
Configuring the Redirect-URL	266
Configuring the Login URL	266
Defining Netdestination Descriptions	267
Configuring a Whitelist	267
Configuring the Netdestination for a Whitelist:	267
Associating a Whitelist to Captive Portal Profile	267
Applying a Captive Portal Profile to a User-Role	267
Verifying a Whitelist Configuration	268
Verifying a Captive Portal Profile Linked to a Whitelist	268
Verifying Dynamic ACLs for a Whitelist	268
Verifying DNS Resolved IP Addresses for Whitelisted URLs	269
Virtual Private Networks	271
Planning a VPN Configuration	271
Selecting an IKE protocol	272
Understanding Suite-B Encryption Licensing	272
Working with IKEv2 Clients	273
Understanding Supported VPN AAA Deployments	273
Working with Certificate Groups	274
Working with VPN Authentication Profiles	274
Configuring a Basic VPN for L2TP/IPsec in the WebUI	275
Defining Authentication Method and Server Addresses	276
Defining Address Pools	276
Enabling Source NAT	276

Selecting Certificates	276
Defining IKEv1 Shared Keys	277
Configuring IKE Policies	277
Setting the IPsec Dynamic Map	278
Finalizing WebUI changes	278
Configuring a VPN for L2TP/IPsec with IKEv2 in the WebUI	279
Defining Authentication Method and Server Addresses	279
Defining Address Pools	280
Enabling Source NAT	280
Selecting Certificates	280
Configuring IKE Policies	281
Setting the IPsec Dynamic Map	282
Finalizing WebUI changes	282
Configuring a VPN for Smart Card Clients	283
Working with Smart Card clients using IKEv2	283
Working with Smart Card Clients using IKEv1	284
Configuring a VPN for Clients with User Passwords	284
In the WebUI	284
In the CLI	285
Configuring Remote Access VPNs for XAuth	285
Configuring VPNs for XAuth Clients using Smart Cards	285
Configuring a VPN for XAuth Clients Using a Username and Password	287
Working with Remote Access VPNs for PPTP	287
In the WebUI	288
In the CLI	288
Working with Site-to-Site VPNs	288
Working with Third-Party Devices	288
Working with Site-to-Site VPNs with Dynamic IP Addresses	289
Understanding VPN Topologies	289
Configuring Site-to-Site VPNs	289
In the WebUI	289
In the CLI	291

Detecting Dead Peers	292
Understanding Default IKE policies	293
Working with VPN Dialer	293
Configuring VPN Dialer	294
In the WebUI	294
In the CLI	294
Assigning a Dialer to a User Role	294
In the WebUI	295
In the CLI	295
Roles and Policies	296
Configuring Firewall Policies	296
Working With Access Control Lists (ACLs)	297
Support for Desktop Virtualization Protocols	297
Creating a Firewall Policy	297
In the WebUI	299
In the CLI	299
Creating a Network Service Alias	300
In the WebUI	300
In the CLI	300
Creating an ACL White List	300
In the WebUI	301
Configuring the ACL White List in the WebUI	301
Configuring the White List Bandwidth Contract in the CLI	301
Configuring the ACL White List in the CLI	301
Creating User Roles	302
Creating a User Role	303
In the WebUI	303
In the CLI	303
Bandwidth Contracts	303
Configuring a Bandwidth Contract in the WebUI	304
Assigning a Bandwidth Contract to a User Role in the WebUI	304
Configuring and Assigning Bandwidth Contracts in the CLI	304

Bandwidth Contract Exceptions	304
Viewing the Current Exceptions List	305
Configuring Bandwidth Contract Exceptions	305
Assigning User Roles	305
Assigning User Roles in AAA Profiles	305
In the WebUI	306
In the CLI	306
Working with User-Derived VLANs	306
Understanding Device Identification	307
Configuring a User-derived VLAN in the WebUI	307
Configuring a User-derived Role or VLAN in the CLI	308
User-Derived Role Example	308
Configuring a Default Role for Authentication Method	309
In the WebUI	309
In the CLI	309
Configuring a Server-Derived Role	310
Configuring a VSA-Derived Role	310
Understanding Global Firewall Parameters	310
Virtual APs	315
Configuring Virtual AP Profiles	315
Excluding a Virtual AP Profile From an AP in the WebUI	316
Excluding a Virtual AP Profile From an AP in the CLI	316
Configuring a Virtual AP	316
Configuring the WLAN	317
Configuring the User Role	317
In the WebUI	317
In the CLI	318
Configuring Authentication Servers	318
In the WebUI	318
In the CLI	318
Configuring Authentication	318
In the WebUI	318

In the CLI	320
Applying the Virtual AP	320
In the WebUI	320
In the CLI	324
Creating a new SSID Profile	324
In the WebUI	325
In the CLI	329
Configuring an SSID for Suite-B Cryptography	329
Configuring a Guest WLAN	330
Configuring a VLAN	330
In the WebUI	330
In the CLI	330
Configuring a Guest Role	330
In the WebUI	330
In the CLI	331
Configuring a Guest Virtual AP	331
In the WebUI	331
In the CLI	332
Enabling bSec SSID Support	332
In the CLI	332
In the WebUI	332
Sample Configuration	332
Enabling 802.11k Support	333
In the WebUI	333
In the CLI	335
	336
Working with Radio Resource Management Information Elements	336
Working with Beacon Report Requests	337
Working with a Traffic Stream Measurement Report	339
Configuring a High-Throughput Virtual AP	340
In the WebUI	341
In the CLI	344

Managing High-Throughput Profiles	345
In the WebUI	345
Adaptive Radio Management (ARM)	346
Understanding ARM	346
ARM Support for 802.11n	347
Monitoring Your Network with ARM	347
Configuring ARM Scanning	347
Understanding ARM Application Awareness	347
Configuring ARM Profiles	348
Creating a New ARM Profile	348
Copying an Existing Profile	349
Deleting a Profile	349
Configuring ARM Settings	349
In the WebUI	349
In the CLI	354
Assigning an ARM Profile to an AP Group	355
In the WebUI	355
In the CLI	355
Using Multi-Band ARM for 802.11a/802.11g Traffic	356
Enabling Band Steering	356
Steering Modes	356
Enabling Band Steering	357
In the WebUI	357
In the CLI	357
Enabling Traffic Shaping	358
Enabling Traffic Shaping	358
In the WebUI	358
In the CLI	359
Enabling Spectrum Load Balancing	359
Reusing Channels to Control RX Sensitivity Tuning	360
Configuring Non-802.11 for Noise Interference Immunity	360
ARM Metrics	361

Troubleshooting ARM	362
Too many APs on the Same Channel	362
Wireless Clients Report a Low Signal Level	362
Transmission Power Levels Change Too Often	362
APs Detect Errors but Do Not Change Channels	363
APs Don't Change Channels Due to Channel Noise	363
Wireless Intrusion Prevention	364
Working with the Reusable Wizard	364
Understanding Wizard Intrusion Detection	365
Understanding Wizard Intrusion Protection	366
Protecting Your Infrastructure	366
Protecting Your Clients	366
Monitoring the Dashboard	367
Detecting Rogue APs	368
Understanding Classification Terminology	368
Understanding Classification Methodology	368
Understanding Match Methods	369
Understanding Match Types	369
Understanding Suspected Rogue Confidence Level	369
Understanding AP Classification Rules	370
Understanding SSID specification	370
Understanding SNR specification	370
Understanding Discovered-AP-Count specification	370
Sample Rules	370
Understanding Rule Matching	370
Working with Intrusion Detection	371
Understanding Infrastructure Intrusion Detection	371
Detecting an 802.11n 40MHz Intolerance Setting	374
Detecting Active 802.11n Greenfield Mode	374
Detecting Ad hoc Networks	374
Detecting an Ad hoc Network Using a Valid SSID	374
Detecting an AP Flood Attack	374

Detecting AP Impersonation	374
Detecting AP Spoofing	374
Detecting Bad WEP Initialization	375
Detecting a Beacon Frame Spoofing Attack	375
Detecting a Client Flood Attack	375
Detecting an RTS Rate Anomaly	375
Detecting Devices with an Invalid MAC OUI	375
Detecting an Invalid Address Combination	375
Detecting an Overflow EAPOL Key	375
Detecting Overflow IE Tags	375
Detecting a Malformed Frame-Assoc Request	375
Detecting Malformed Frame-Auth	376
Detecting a Malformed Frame-HT IE	376
Detecting a Malformed Frame-Large Duration	376
Detecting a Misconfigured AP	376
Detecting a Windows Bridge	376
Detecting a Wireless Bridge	376
Detecting Broadcast Deauthentication	376
Detecting Broadcast Disassociation	376
Detecting Netstumbler	376
Detecting Valid SSID Misuse	376
Detecting Wellenreiter	377
Understanding Client Intrusion Detection	377
Detecting a Block ACK DoS	379
Detecting a ChopChop Attack	379
Detecting a Disconnect Station Attack	379
Detecting an EAP Rate Anomaly	379
Detecting a FATA-Jack Attack Structure	379
Detecting a Hotspotter Attack	379
Detecting a Meiners Power Save DoS Attack	379
Detecting an Omerta Attack	380
Detecting Rate Anomalies	380

Detecting a TKIP Replay Attack	380
Detecting Unencrypted Valid Clients	380
Detecting a Valid Client Misassociation	380
Detecting an AirJack Attack	380
Detecting ASLEAP	380
Detecting a Null Probe Response	380
Configuring Intrusion Protection	381
Understanding Infrastructure Intrusion Protection	381
Protecting 40MHz 802.11 High Throughput Devices	382
Protecting 802.11n High Throughput Devices	382
Protecting Against Adhoc Networks	382
Protecting Against AP Impersonation	382
Protecting Against Misconfigured APs	382
Protecting SSIDs	382
Protecting Against Rogue Containment	382
Protecting Against Suspected Rogue Containment	382
Understanding Client Intrusion Protection	382
Protecting Valid Stations	383
Protecting Windows Bridge	383
Configuring the WLAN Management System (WMS)	383
In the WebUI	383
In the CLI	384
Configuring Local WMS Settings	384
Managing the WMS Database	384
Understanding Client Blacklisting	385
Methods of Blacklisting	385
Blacklisting Manually	385
Blacklisting by Authentication Failure	386
Enabling Attack Blacklisting	386
Setting Blacklist Duration	387
Removing a Client from Blacklisting	387
Working with WIP Advanced Features	387

Configuring TotalWatch	388
Understanding TotalWatch Channel Types and Qualifiers	388
Understanding TotalWatch Monitoring Features	389
Understanding TotalWatch Scanning Spectrum Features	389
Understanding TotalWatch Channel Dwell Time	389
Understanding TotalWatch Channel Visiting	390
Understanding TotalWatch Age out of Devices	390
Administering TotalWatch	390
Configuring Per Radio Settings	390
Configuring Per AP Setting	390
Licensing	392
Working with Tarpit Shielding	392
Configuring Tarpit Shielding	392
EnablingTarpit Shielding	392
Understanding Tarpit Shielding Licensing CLI Commands	392
Access Points (APs)	393
Basic Functions and Features	393
Naming and Grouping APs	394
Creating an AP group	395
In the WebUI	395
In the CLI	395
Assigning APs to an AP Group	395
In the WebUI	395
In the CLI	396
Understanding AP Configuration Profiles	396
Working with Wireless LAN Profiles	396
Working with AP Profiles	399
Working with QoS Profiles	399
Working with RF Management Profiles	400
Provisioning Mesh Profiles	400
Other Profiles	401
Viewing Profile Errors	401

Profile Hierarchy	401
Deploying APs	404
Running the RF Plan	404
Verifying that APs Can Connect to the Controller	404
Configuring Firewall Settings	404
Enabling Controller Discovery	405
Configuring DNS Resolution	405
Configuring DHCP Server Communication with APs	405
Using the Aruba Discovery Protocol (ADP)	406
Verifying that APs Are Receiving IP Addresses	406
In the WebUI	406
In the CLI	407
Provisioning APs for Mesh	407
Provisioning 802.11n APs for Single-Chain Transmission	407
Installing APs on the Network	408
Updating the RF Plan	409
Provisioning Installed APs	409
Designation an AP as Remote (RAP) versus Campus (CAP)	409
Working with the AP Provisioning Wizard	409
Provisioning an Individual AP	410
Provisioning Multiple APs using a Provisioning Profile	413
Assigning Provisioning Profiles	414
Troubleshooting	415
Configuring a Provisioned AP	415
AP Installation Modes	415
Using the WebUI	415
Using the CLI	416
Renaming an AP	416
Using the WebUI	416
Using the CLI	416
Optimize APs Over Low-Speed Links	417
Configuring the Bootstrap Threshold	417

Prioritizing AP heartbeats	420
AP Redundancy	421
Using the WebUI	421
Using the CLI	421
AP Maintenance Mode	421
Using the WebUI	422
Using the CLI	422
Energy Efficient Ethernet	422
Using the WebUI	422
Using the CLI	423
Managing AP LEDs	423
Using the WebUI	423
Using the CLI	424
RF Management	424
802.11a and 802.11g RF Management Profiles	424
Managing 802.11a/802.11g Profiles Using the WebUI	425
Creating or Editing a Profile	425
Assigning an 802.11a/802.11g Profile	429
Assigning a High-throughput Profile	429
Assigning an ARM Profile	430
Deleting a Profile	431
Managing 802.11a/802.11g Profiles Using the CLI	431
Creating or Modifying a Profile	431
Viewing RF Management Settings	432
Assigning a 802.11a/802.11g Profile	432
Deleting a Profile	432
RF Optimization	432
Using the WebUI	432
Using the CLI	433
RF Event Configuration	433
Using the WebUI	433
Using the CLI	435

Configuring AP Channel Assignments	435
Using the WebUI	435
Using the CLI	436
Channel Switch Announcement (CSA)	436
Using the WebUI	436
Using the CLI	437
Automatic Channel and Transmit Power Selection	437
Managing AP Console Settings	437
Secure Enterprise Mesh	439
Understanding Mesh Access Points	439
Mesh Portals	440
Mesh Points	440
Mesh Clusters	441
Understanding Mesh Links	441
Link Metrics	442
Optimizing Links	442
Understanding Mesh Profiles	443
Mesh Cluster Profile	443
Mesh Radio Profile	443
RF Management (802.11a and 802.11g) Profiles	443
Adaptive Radio Management Profiles	444
High-Throughput Profiles	444
Mesh High-Throughput SSID Profile	444
Wired AP Profile	445
Mesh Recovery Profile	445
Understanding Mesh Solutions	445
Thin AP Services with Wireless Backhaul Deployment	446
Point-to-Point Deployment	446
Point-to-Multipoint Deployment	446
High-Availability Deployment	447
Planning a WLAN According to Your Specifications	448
Task Overview	448

Collecting Required Information	448
Working with Mesh Radio Profiles	450
Managing Mesh Profiles In the WebUI	450
Creating a New Profile	450
Assigning a Profile to a Mesh AP or AP Group	453
Editing a Profile	453
Deleting a Profile	454
Managing Mesh Profiles In the CLI	454
Creating or Modifying a Profile	454
Viewing Profile Settings	454
Assigning a Profile to an AP Group	455
Deleting a Mesh Radio Profile	455
Working with Mesh High Throughput SSID Profiles	455
Managing Profiles In the WebUI	455
Creating a Profile	455
Assigning a Profile to an AP Group	457
Editing a Profile	458
Deleting a Profile	458
Managing Profiles In the CLI	458
Creating or Modifying a Profile	458
Assigning a Profile to an AP Group	459
Viewing High-throughput SSID Settings	459
Deleting a Profile	459
Understanding Mesh Cluster Profiles	459
Deployments with Multiple Mesh Cluster Profiles	459
Managing Mesh Cluster Profiles In the WebUI	460
Creating a Profile	460
Associating a Profile to Mesh APs	461
Editing a Profile	462
Deleting a Mesh Cluster Profile	462
Managing Mesh Cluster Profiles In the CLI	462
Viewing Mesh Cluster Profile Settings	463

Associating Mesh Cluster Profiles	463
Excluding a Mesh Cluster Profile from a Mesh Node	464
Deleting a Mesh Cluster Profile	464
Configuring Ethernet Ports for Mesh	464
Configuring Bridging on the Ethernet Port	464
Configuring Ethernet Ports for Secure Jack Operation	465
In the WebUI	465
In the CLI	466
Extending the Life of a Mesh Network	466
In the WebUI	466
In the CLI	466
Provisioning Mesh Nodes	467
Outdoor AP Parameters	467
Provisioning Caveats	468
Provisioning Mesh Nodes	468
In the WebUI	468
In the CLI	469
Understanding the AP Boot Sequence	469
Booting the Mesh Portal	469
Booting the Mesh Point	469
Air Monitoring and Mesh	470
Verifying the Network	470
Verification Checklist	470
CLI Examples	471
Configuring Remote Mesh Portals (RMPs)	471
How RMP Works	472
Creating a Remote Mesh Portal In the WebUI	472
Provisioning the AP	473
Defining the Mesh Private VLAN	473
Selecting a Mesh Radio Profile	474
Selecting an RF Management Profile	474
Adding a Mesh Cluster Profile	474

Configuring a DHCP Pool	475
Configuring the VLAN ID of the Virtual AP Profile	475
Provisioning a Remote Mesh Portal In the CLI	476
Additional Information	476
VRRP	477
Configuring Redundancy Parameters	477
Configuring the Local Controller for Redundancy	478
In the WebUI	479
In the CLI	479
Configuring the LMS IP	479
In the WebUI	479
In the CLI	479
Configuring the Master Controller for Redundancy	479
Configuring Database Synchronization	481
In the WebUI	481
In the CLI	481
Enabling Incremental Configuration Synchronization (CLI Only)	482
Configuring Master-Local Controller Redundancy	482
RSTP	485
Understanding RSTP Migration and Interoperability	485
Working with Rapid Convergence	485
Edge Port and Point-to-Point	487
Configuring RSTP	487
In the WebUI	487
In the CLI	488
Monitoring RSTP	488
Troubleshooting RSTP	488
PVST+	490
Understanding PVST+ Interoperability and Best Practices	490
Enabling PVST+ in the CLI	490
Enabling PVST+ in the WebUI	491
IP Mobility	492

Understanding Dell Mobility Architecture	492
Configuring Mobility Domains	493
Configuring a Mobility Domain	494
Using the WebUI	494
Using the CLI	494
Joining a Mobility Domain	495
In the WebUI	495
In the CLI	495
Example Configuration	495
Configuring Mobility using the WebUI	496
Configuring Mobility using the CLI	497
Tracking Mobile Users	497
Mobile Client Roaming Status	497
Viewing mobile client status using the WebUI	497
Viewing mobile client status using the CLI	497
Viewing user roaming status using the CLI	498
Viewing specific client information using the CLI	498
Mobile Client Roaming Locations	499
In the WebUI	499
In the CLI	499
HA Discovery on Association	499
Setting up mobility association Using the CLI	499
Configuring Advanced Mobility Functions	499
In the WebUI	499
In the CLI	502
Proxy Mobile IP	502
Proxy DHCP	502
Revocations	503
Understanding Bridge Mode Mobility Deployments	503
Enabling Mobility Multicast	504
Working with Proxy IGMP and Proxy Remote Subscription	504
Working with Inter controller Mobility	504

Configuring Mobility Multicast	505
In the WebUI	505
In the CLI	506
Example	506
External Firewall Configuration	507
Understanding Firewall Port Configuration Among Dell Devices	507
Enabling Network Access	508
Ports Used for Virtual Internet Access (VIA)	508
Configuring Ports to Allow Other Traffic Types	508
Remote Access Points	510
About Remote Access Points	510
Configuring the Secure Remote Access Point Service	512
Configure a Public IP Address for the Controller	512
Using the WebUI to create a DMZ address	512
Using CLI	512
Configure the NAT Device	512
Configure the VPN Server	513
Using the WebUI	513
Using CLI	513
CHAP Authentication Support over PPPoE	513
Using the WebUI to configure CHAP	513
Using the CLI to configure the CHAP	514
Configuring Certificate RAP	514
Using WebUI	514
Using CLI	514
Creating a Remote AP Whitelist	514
Configuring PSK RAP	515
Add the user to the internal database	515
Using WebUI	515
Using CLI	515
RAP Static Inner IP Address	515
Using the WebUI	515

Using the CLI	516
Provision the AP	516
Deploying a Branch Office/Home Office Solution	517
Provisioning the Branch Office AP	518
Configuring the Branch Office AP	518
Troubleshooting Remote AP	518
Local Debugging	518
Remote AP Summary	518
Multihoming on remote AP (RAP)	520
Seamless failover from backup link to primary link on RAP	520
Remote AP Connectivity	520
Remote AP Diagnostics	521
Enabling Remote AP Advanced Configuration Options	521
Understanding Remote AP Modes of Operation	522
Working in Fallback Mode	523
Backup Configuration Behavior for Wired Ports	524
Configuring Fallback Mode	524
Configuring the AAA Profile for Fallback Mode in the WebUI	524
Configuring the AAA Profile for Fallback Mode in the CLI	525
Configuring the Virtual AP Profile for Fallback Mode in the WebUI	525
Configuring the Virtual AP Profile for Fallback Mode in the CLI	526
Configuring the DHCP Server on the Remote AP	526
Using the WebUI	527
Using CLI	527
Configuring Advanced Backup Options	528
Configuring the Session ACL in the WebUI	528
Configuring the AAA Profile in the WebUI	529
Defining the Backup Configuration in the WebUI	530
Configuring the Session ACL in the CLI	530
Using the CLI to configure the AAA profile	531
Defining the Backup Configuration in the CLI	531
Specifying the DNS Controller Setting	531

In the WebUI	532
Backup Controller List	532
Configuring the LMS and backup LMS IP addresses in the WebUI	533
Configuring the LMS and backup LMS IP addresses in the CLI	533
Configuring Remote AP Failback	533
In the WebUI	533
In the CLI	534
Enabling RAP Local Network Access	534
In the WebUI	534
In the CLI	534
Configuring Remote AP Authorization Profiles	534
Adding or Editing a Remote AP Authorization Profile	535
Working with Access Control Lists and Firewall Policies	535
Understanding Split Tunneling	535
Configuring Split Tunneling	536
Configuring the Session ACL Allowing Tunneling	537
Using the WebUI	537
Using the CLI	538
Configuring an ACL to Restrict Local Debug Homepage Access	538
In the WebUI	538
In the CLI	539
Configuring the AAA Profile for Tunneling	539
In the WebUI	539
In the CLI	540
Configuring the Tunneling Virtual AP Profile	540
In the WebUI	540
In the CLI	541
Defining Corporate DNS Servers	541
In the WebUI	541
In the CLI	541
Provisioning Wi-Fi Multimedia	541
Reserving Uplink Bandwidth	542

Understanding Bandwidth Reservation for Uplink Voice Traffic	542
Configuring Bandwidth Reservation	542
In the WebUI	542
In the CLI	542
Provisioning 4G USB Modems on Remote Access Points	543
4G USB Modem Provisioning Best Practices and Exceptions	543
Provisioning RAP for USB Modems	543
In the WebUI	543
In the CLI	544
RAP 3G/4G Backhaul Link Quality Monitoring	544
Configuring W-IAP3WN Access Points	545
Using the WebUI	545
Using the CLI	545
Converting an IAP to RAP or CAP	546
Converting IAP to RAP	546
Converting an IAP to CAP	546
Enabling Bandwidth Contract Support for RAPs	547
Configuring Bandwidth Contracts for RAP	547
Defining Bandwidth Contracts	547
Applying Contracts	547
Applying Contracts Per-Role	547
Applying Contracts Per-User	547
Verifying Contracts on AP	548
Verifying Contracts Applied to Users	548
Verifying Bandwidth Contracts During Data Transfer	549
Virtual Intranet Access	551
Understanding VIA Connection Manager	551
How it Works	551
Installing the VIA Connection Manager	552
On Microsoft Windows Computers	552
On Apple MacBooks	552
Upgrade Workflow	553

Minimal Upgrade	553
Complete Upgrade	553
VIA Compatibility	553
Configuring the VIA Controller	553
Before you Begin	554
Supported Authentication Mechanisms	554
Authentication mechanisms supported in VIA 1.x	554
Authentication mechanisms supported in VIA 2.x	554
Other authentication methods:	554
Suite B Cryptography Support	554
802.11 Suite-B	555
Configuring VIA Settings	555
Using the WebUI to Configure VIA	556
Enable VPN Server Module	556
Create VIA User Roles	556
Create VIA Authentication Profile	556
Create VIA Connection Profile	557
Configure VIA Web Authentication	561
Associate VIA Connection Profile to User Role	562
Configure VIA Client WLAN Profiles	562
Rebranding VIA and Downloading the Installer	564
Download VIA Installer and Version File	564
Customize VIA Logo	565
Customize the Landing Page for Web-based Login	565
Using the CLI to Configure VIA	565
Create VIA roles	565
Create VIA authentication profiles	565
Create VIA connection profiles	565
Configure VIA web authentication	566
Associate VIA connection profile to user role	566
Configure VIA client WLAN profiles	566
Customize VIA logo, landing page and downloading installer	566

Downloading VIA	566
Pre-requisites	566
Downloading VIA	567
Installing VIA	568
Using VIA	568
Connection Details Tab	568
Diagnostic Tab	569
Settings Tab	569
Troubleshooting	569
Spectrum Analysis	570
Understanding Spectrum Analysis	570
Spectrum Analysis Clients	573
Hybrid AP Channel Changes	574
Hybrid APs Using Mode-Aware ARM	574
Creating Spectrum Monitors and Hybrid APs	574
Converting APs to Hybrid APs	575
In the WebUI	575
In the CLI	575
Converting an Individual AP to a Spectrum Monitor	575
In the WebUI	576
In the CLI	576
Converting a Group of APs to Spectrum Monitors	576
In the WebUI	576
In the CLI	577
Connecting Spectrum Devices to the Spectrum Analysis Client	577
View Connected Spectrum Analysis Devices	578
Disconnecting a Spectrum Device	578
Configuring the Spectrum Analysis Dashboards	579
Selecting a Spectrum Monitor	579
Changing Graphs within a Spectrum View	580
Renaming a Spectrum Analysis Dashboard View	581
Saving a Dashboard View	581

Resizing an Individual Graph	582
Customizing Spectrum Analysis Graphs	582
Spectrum Analysis Graph Configuration Options	583
Active Devices	583
Active Devices Table	585
Active Devices Trend	587
Channel Metrics	588
Channel Metrics Trend	590
Channel Summary Table	592
Device Duty Cycle	593
Channel Utilization Trend	594
Devices vs Channel	595
FFT Duty Cycle	597
Interference Power	598
Quality Spectrogram	600
Real-Time FFT	601
Swept Spectrogram	603
Working with Non-Wi-Fi Interferers	606
Understanding the Spectrum Analysis Session Log	608
Viewing Spectrum Analysis Data	608
Recording Spectrum Analysis Data	609
Creating a Spectrum Analysis Record	609
Saving the Recording	610
Playing a Spectrum Analysis Recording	610
Playing a Recording in the Spectrum Dashboard	610
Playing a Recording Using the RFPlayback Tool	611
Troubleshooting Spectrum Analysis	612
Verifying Spectrum Monitors Support for One Client per Radio	612
Converting a Spectrum Monitor Back to an AP or Air Monitor	612
Troubleshooting Browser Issues	612
Loading a Spectrum View	612
Troubleshooting Issues with Adobe Flash Player 10.1 or Later	613

Understanding Spectrum Analysis Syslog Messages	613
Playing a Recording in the RFPlayback Tool	613
Understanding Device Ageout Times	613
Dashboard Monitoring	615
Monitoring Performance	615
Clients	615
APs	615
Using Dashboard Histograms	616
Monitoring Usage	616
Clients	616
APs	616
Monitoring Security	617
Monitoring Potential Issues	617
Monitoring WLANs	617
Monitoring Access Points	618
Monitoring Clients	618
Monitoring Firewalls	619
In the WebUI	619
In the CLI	619
Element View	619
Details View	621
Element Tab	621
Element Summary View	621
Usage Breakdown	622
Aggregated Sessions	623
Management Access	625
Configuring Certificate Authentication for WebUI Access	625
In the WebUI	625
In the CLI	626
Enabling Public Key Authentication for SSH Access	626
In the WebUI	626
In the CLI	627

Enabling RADIUS Server Authentication	627
Configuring RADIUS Server Username and Password Authentication	627
In the WebUI	627
In the CLI	627
Configuring RADIUS Server Authentication with VSA	628
Configuring RADIUS Server Authentication with Server Derivation Rule	628
In the WebUI	628
In the CLI	629
Configuring a set-value server-derivation rule	629
In the WebUI	629
In the CLI	630
Disabling Authentication of Local Management User Accounts	630
In the WebUI	630
In the CLI	630
Verifying the configuration	630
Resetting the Admin or Enable Password	630
Bypassing the Enable Password Prompt	631
Setting an Administrator Session Timeout	632
In the WebUI	632
In the CLI	632
Implementing a Specific Management Password Policy	632
Defining a Management Password Policy	632
In the WebUI	632
Management Authentication Profile Parameters	634
Managing Certificates	635
About Digital Certificates	635
Obtaining a Server Certificate	636
In the WebUI	636
In the CLI	637
Obtaining a Client Certificate	637
Importing Certificates	637
In the WebUI	637

In the CLI	638
Viewing Certificate Information	638
Imported Certificate Locations	638
Checking CRLs	639
Configuring SNMP	639
SNMP Parameters for the Controller	639
In the WebUI	640
In the CLI	640
Configuring Logging	640
In the WebUI	642
In the CLI	642
Enabling Guest Provisioning	643
Configuring the Guest Provisioning Page	643
In the WebUI	643
Configuring the Guest Fields	643
Configuring the Page Design	645
Configuring Email Messages	646
Configuring the SMTP Server and Port in the WebUI	646
Configuring an SMTP server and port in the CLI	647
Creating Email Messages in the WebUI	647
Configuring a Guest Provisioning User	648
In the WebUI	648
Username and Password Authentication Method	648
Static Authentication Method	648
Smart Card Authentication Method	649
In the CLI	649
Username and Password Method	649
Static Authentication Method	649
Smart Card Authentication Method	649
Customizing the Guest Access Pass	649
Creating Guest Accounts	650
Guest Provisioning User Tasks	651

Importing Multiple Guest Entries	652
Creating Multiple Guest Entries in a CSV File	652
Importing the CSV File into the Database	653
Printing Guest Account Information	656
Optional Configurations	656
Restricting one Captive Portal Session for each Guest	656
Using the CLI to restrict one Captive Portal session for each guest	657
Setting the Maximum Time for Guest Accounts	657
Using the WebUI to set the maximum time for guest accounts	657
Using the CLI to set the maximum time for guest accounts	657
Managing Files on the Controller	657
Transferring ArubaOS Image Files	658
In the WebUI	658
In the CLI	658
Backing Up and Restoring the Flash File System	659
Backup the Flash File System in the WebUI	659
Backup the Flash File System in the CLI	659
Restore the Flash File System in the WebUI	659
Restore the Flash File System in the CLI	659
Copying Log Files	659
In the WebUI	659
In the CLI	659
Copying Other Files	660
In the WebUI	660
In the CLI	660
Setting the System Clock	660
Manually Setting the Clock	660
In the WebUI	660
In the CLI	660
Clock Synchronization	661
In the WebUI	661
In the CLI	661

Configuring NTP Authentication	661
In the WebUI	661
In the CLI	662
Timestamps in CLI Output	662
Enabling Capacity Alerts	662
In the WebUI	663
In the CLI	663
Examples	663
Adding Local Controllers	664
Configuring Local Controllers	664
Using the Initial Setup	664
Using the Web UI	665
Using the CLI	665
Configuring Layer-2/Layer-3 Settings	665
Configuring Trusted Ports	665
Configuring Local Controller Settings	665
Configuring APs	666
Using the WebUI to configure the LMS IP	666
Using the CLI to configure the LMS IP	666
Moving to a Multi-Controller Environment	666
Configuring a Preshared Key	667
Using the WebUI to configure a Local Controller PSK	668
Using the WebUI to configure a Master Controller PSK	668
Using the CLI to configure a PSK	668
Master Controller	668
Local Controller	668
Configuring a Controller Certificate	668
Using the CLI to configure a Local Controller Certificate	668
Using the CLI to configure the Master Controller Certificate	669
Advanced Security	670
Securing Client Traffic	670
Securing Wireless Clients	671

In the WebUI	671
In the CLI	672
Securing Wired Clients	672
In the WebUI	673
In the CLI	674
Securing Wireless Clients Through Non-Dell APs	674
In the WebUI	674
In the CLI	675
Securing Clients on an AP Wired Port	675
In the WebUI	675
In the CLI	676
Securing Controller-to-Controller Communication	677
Configuring Controllers for xSec	677
In the WebUI	677
In the CLI	677
Configuring the Odyssey Client on Client Machines	678
Installing the Odyssey Client	678
Voice and Video	682
Voice and Video License Requirements	682
Configuring Voice and Video	682
Setting up Net Services	682
Using Default Net Services	682
Creating Custom Net Services	683
Configuring User Roles	683
Using the Default User Role	683
Creating or Modifying Voice User Roles	684
Using the WebUI to configure user roles	684
Using the CLI to configure a user role	685
Using the User-Derivation Roles	686
Using the WebUI to derive the role based on SSID	686
Using the CLI to derive the role based on SSID	686
Using the WebUI to derive the role based on MAC OUI	686

Using the CLI to derive the role based on MAC OUI	686
Configuring Firewall Settings for Voice and Video ALGs	687
In the WebUI	687
In the CLI	687
Additional Video Configurations	687
Configuring Video over WLAN enhancements	687
Pre-requisites	688
In the CLI	688
In the WebUI	691
Working with QoS for Voice and Video	694
Understanding VoIP Call Admission Control Profile	695
In the WebUI	695
In the CLI	696
Understanding Wi-Fi Multimedia	696
Enabling WMM	697
In the WebUI	697
In the CLI	697
Configuring WMM AC Mapping	697
Using the WebUI to map between WMM AC and DSCP	698
Using the CLI to map between WMM AC and DSCP	699
Configuring DSCP Priorities	699
Configuring Dynamic WMM Queue Management	700
Enhanced Distributed Channel Access	700
Using the WebUI to configure EDCA parameters	701
Using the CLI to configure EDCA parameters	702
Enabling WMM Queue Content Enforcement	702
In the WebUI	702
In the CLI	702
Understanding Extended Voice and Video Features	703
Understanding QoS for Microsoft Office OCS and Apple Facetime	703
Microsoft OCS	703
Apple Facetime	703

Enabling WPA Fast Handover	704
In the WebUI	704
In the CLI	704
Enabling Mobile IP Home Agent Assignment	704
Scanning for VoIP-Aware ARM	704
In the WebUI	704
In the CLI	705
Disabling Voice-Aware 802.1x	705
In the WebUI	705
In the CLI	705
Configuring SIP Authentication Tracking	705
In the WebUI	705
In the CLI	706
Enabling Real Time Call Quality Analysis	706
In the Web UI	706
Viewing Real Time Call Quality Reports	706
In the CLI	706
Enabling SIP Session Timer	707
In the WebUI	707
In the CLI	708
Enabling Voice and Video Traffic Awareness for Encrypted Signaling Protocols	708
In the WebUI	708
In the CLI	709
Enabling Wi-Fi Edge Detection and Handover for Voice Clients	709
In the WebUI	710
In the CLI	710
Working with Dial Plan for SIP Calls	710
Understanding Dial Plan Format	710
Configuring Dial Plans	711
In the WebUI	711
In the CLI	713
Enabling Enhanced 911 Support	713

Working with Voice over Remote Access Point	714
Understanding Battery Boost	715
In the WebUI	715
In the CLI	715
Enabling LLDP	715
In the WebUI	716
In the CLI	719
Advanced Voice Troubleshooting	720
Viewing Troubleshooting Details on Voice Client Status	720
In the WebUI	720
In the CLI	720
Viewing Troubleshooting Details on Voice Call CDRs	722
In the WebUI	722
In the CLI	722
Enabling Voice Logs	723
In the WebUI	723
Enabling Logging for a Specific Client	723
In the CLI	724
Viewing Voice Traces	724
In the WebUI	724
In the CLI	724
Viewing Voice Configurations	725
In the CLI	725
Instant AP VPN Support	727
Overview	727
Termination of Instant AP VPN tunnels	727
Termination of IAP GRE tunnels	727
L2/L3 network mode support	727
VPN Configuration	728
Whitelist DB Configuration	728
Controller Whitelist DB	728
External Whitelist DB	728

VPN Local Pool Configuration	729
VPN Profile Configuration	729
Radius proxy for VPN connected IAPs	729
Viewing Branch Status	729
Example	729
W-600 Series Controllers	731
Understanding W-600 Series Best Practices and Exceptions	731
Connecting with a USB Cellular Modems	732
How it Works	732
Switching Modes	732
Finding USB Modem Commands	732
Uplink Manager	733
Cellular Profile	733
Dialer Group	734
Configuring a Supported USB Modem	735
Configuring a New USB Modem	736
Configuring the Profile and Modem Driver	736
Configuring the TTY Port	737
Testing the TTY Port	738
Selecting the Dialer Profile	738
Linux Support	739
Setting Up NAS (Network-Attached Storage) Devices	739
NAS Device Setup	739
Configuring in the CLI	740
Managing NAS Devices	740
Mounting and Unmounting Devices	741
Connecting to a Print Server	742
Printer Setup Using the CLI	742
Additional Commands for Managing Printers	742
W-600 Series Sample Topology and Configuration	743
Remote Branch 1—W-650 Controller	743
Remote Branch 2—W-650 Controller	744

W-3200 Central Office Controller—Active	745
W-3200 Central Office Controller—Backup	746
External Services Interface	748
Sample ESI Topology	748
Understanding the ESI Syslog Parser	750
ESI Parser Domains	750
Peer Controllers	751
Syslog Parser Rules	751
Condition Pattern Matching	752
User Pattern Matching	752
Configuring ESI	752
Configuring Health-Check Method, Groups, and Servers	753
In the WebUI	753
In the CLI	753
Defining the ESI Server	753
In the WebUI	753
In the CLI	754
Defining the ESI Server Group	754
In the WebUI	754
In the CLI	755
Redirection Policies and User Role	755
In the WebUI	755
In the CLI	755
ESI Syslog Parser Domains and Rules	756
Managing Syslog Parser Domains in the WebUI	756
Adding a new syslog parser domain	756
Deleting an existing syslog parser domain	756
Editing an existing syslog parser domain	757
Managing Syslog Parser Domains in the CLI	757
Adding a new syslog parser domain	757
Showing ESI syslog parser domain information	757
Deleting an existing syslog parser domain	757

Editing an existing syslog parser domain	757
Managing Syslog Parser Rules	757
In the WebUI	758
Adding a new parser rule	758
Deleting a syslog parser rule	758
Editing an existing syslog parser rule	758
Testing a Parser Rule	759
In the CLI	759
Adding a new parser rule	759
Showing ESI syslog parser rule information:	760
Deleting a syslog parser rule:	760
Editing an existing syslog parser rule	760
Testing a parser rule	760
Monitoring Syslog Parser Statistics	760
In the WebUI	760
In the CLI	760
Sample Route-mode ESI Topology	760
ESI server configuration on controller	761
IP routing configuration on Fortinet gateway	761
Configuring the Example Routed ESI Topology	761
Health-Check Method, Groups, and Servers	762
Defining the Ping Health-Check Method	762
In the WebUI	762
In the CLI	762
Defining the ESI Server	762
In the WebUI	762
In the CLI	763
Defining the ESI Server Group	763
In the WebUI	763
In the CLI	763
Redirection Policies and User Role	764
In the WebUI	764

In the CLI	764
Syslog Parser Domain and Rules	765
Add a New Syslog Parser Domain in the WebUI	765
Adding a New Parser Rule in the WebUI	765
In the CLI	765
Sample NAT-mode ESI Topology	766
ESI server configuration on the controller	767
Configuring the Example NAT-mode ESI Topology	768
Configuring the NAT-mode ESI Example in the WebUI	768
In the WebUI	768
Configuring the ESI Group in the WebUI	768
Configure the ESI Servers in the WebUI	769
Configuring the Redirection Filter in the WebUI	769
Configuring the Example NAT-mode Topology in the CLI	769
Configuring a Health-Check Ping	770
Configuring ESI Servers	770
Configure an ESI Group, Add the Health-Check Ping and ESI Servers	770
Using the ESI Group in a Session Access Control List	770
CLI Configuration Example 1	770
CLI Configuration Example 2	771
Understanding Basic Regular Expression (BRE) Syntax	771
Character-Matching Operators	771
Regular Expression Repetition Operators	772
Regular Expression Anchors	772
References	773
External User Management	774
Overview	774
Before you Begin	774
Working with the ArubaOS XML API Works	774
Creating an XML Request	775
Adding a User	775
Deleting a User	775

Authenticating a User	775
Blacklisting a User	776
Querying for User Status	776
XML Response	776
Default Response Format	776
Response Codes	777
Query Command Response Format	778
Using the XML API Server	779
Configuring the XML API Server	779
Associating the XML API Server to a AAA profile	779
Set up Captive Portal profile	781
Associating the Captive Portal Profile to an Initial Role	781
Creating an XML API Request	782
Monitoring External Captive Portal Usage Statistics	783
Sample Code	784
Using XML API in C Language	784
Understanding Request and Response	787
Understanding XML API Request Parameters	787
Understanding XMI API Response	788
Adding a Client	788
Response from the controller	788
View the updated details of the client on the controller	789
Deleting a Client	789
Response from the controller	789
Authenticating a Client	789
Status of the client before authentication	790
Sending the authentication command	790
Response from the controller	790
Status of the client after authentication	790
Querying for Client Details	791
Response from the controller	791
Blacklisting a Client	792

Response from the controller	792
RF Plan	793
Supported Planning	793
Planning Deployment	794
Pre-Deployment Considerations	794
Outdoor-Specific Deployment Considerations	794
Configuration Considerations	794
Post-Deployment Considerations	795
Dual-Port AP Considerations	795
Launching the RF Plan	796
Campus List Page	796
Building List Pane	797
Building Specifications Overview	798
Building Dimension Page	798
AP Modeling Parameters Page	799
Radio Type	800
Design Model	801
Overlap Factor	801
Users/AP	802
Radio Properties (Desired Rates and HT Support Options)	802
AM Modeling Page	803
Design Models	804
Monitor Rates	804
Planning Floors Page	804
Zoom	805
Approximate Coverage Map	806
Floor Editor Dialog Box	806
Level	806
Naming	806
Background Images	807
Area Editor Dialog Box	807
Naming	808

Location and Dimensions	808
Area Types	808
Access Point Editor Dialog Box	809
Naming	809
Fixed	809
Radio Types	810
X and Y Coordinates	810
802.11 Types	810
802.11 Channels	810
802.11 Power Levels	810
802.11n Features	810
Memo	811
AP Plan Page	811
Initialize	811
Optimize	811
Viewing the Results	812
Fix All Suggested AP/AMs	812
AM Plan Page	812
Initialize	812
Optimize	813
Viewing the Results	813
Fix All Suggested AP/AMs	813
Exporting and Importing Files	813
Export Campus	814
Import Campus	814
Export Buildings Page	814
Import Buildings Page	815
Locate	815
FQLN Mapper	816
Using the FQLN Mapper in the AP Provision Page	817
Using the WebUI	818
Using the CLI	818

RF Plan Example	818
Sample Building	818
Create a Building	819
Model the Access Points	820
Model the Air Monitors	821
Add and Edit a Floor	821
Adding the background image and naming the first floor	821
Adding the background image and naming the second floor	821
Defining Areas	821
Creating a Don't Care Area	821
Creating a Don't Deploy Area	822
Running the AP Plan	822
Running the AM Plan	823
Behavior and Defaults	824
Understanding Mode Support	824
Understanding Basic System Defaults	825
Network Services	825
Policies	827
Roles	830
Understanding Default Management User Roles	832
Understanding Default Open Ports	835
DHCP with Vendor-Specific Options	837
Configuring a Windows-Based DHCP Server	837
Configuring Option 60	837
To configure option 60 on the Windows DHCP server	837
Configuring Option 43	838
To configure option 43 on the Windows DHCP server:	838
Enabling DHCP Relay Agent Information Option (Option 82)	840
Configuring Option 82	840
In the WebUI	840
In the CLI	840
Enabling Linux DHCP Servers	840

802.1X Configuration for IAS and Windows Clients	842
Configuring Microsoft IAS	842
RADIUS Client Configuration	842
Remote Access Policies	843
Active Directory Database	843
Configuring Policies	843
Configuring RADIUS Attributes	846
Configuring Management Authentication using IAS	847
Creating a Remote Policy	847
Defining Properties for Remote Policy	848
Creating a User Entry in Windows Active Directory	848
Configure the Controller to use IAS Management Authentication	849
Verify Communication between the Controller and the RADIUS Server	850
Window XP Wireless Client Sample Configuration	850
Acronyms and Terms	857
Acronyms	857
Terms	863

About this Guide

This User Guide describes the features supported by Dell PowerConnect W-Series ArubaOS and provides instructions and examples for configuring Dell controllers and Access Points (APs). This guide is intended for system administrators responsible for configuring and maintaining wireless networks and assumes you are knowledgeable in Layer 2 and Layer 3 networking technologies.

This chapter covers the following topics:

- ["What's New In ArubaOS 6.2 "](#) on page 61
- ["Fundamentals"](#) on page 63
- ["Related Documents"](#) on page 64
- ["Conventions"](#) on page 64
- ["Related Documents"](#) on page 64

What's New In ArubaOS 6.2

The following features have been added in the ArubaOS 6.2 release:

Table 1: *New Features in ArubaOS 6.2*

Feature	Description
LLDP	Link Layer Discovery Protocol (LLDP), is a Layer-2 protocol that allows network devices to advertise their identity and capabilities on a LAN. Wired interfaces on Dell APs support LLDP by periodically transmitting LLDP Protocol Data Units (PDUs) comprised of type-length-value (TLV) elements.
Capacity monitoring	The controller will send a <i>wlsxThresholdExceeded</i> SNMP trap and a syslog error message when the controller has exceeded a set percentage of the total capacity for that resource. A <i>wlsxThresholdCleared</i> SNMP trap and error message will be triggered if the resource usage drops below the threshold once again.
Bandwidth contract support for Remote APs	Configure bandwidth contracts for a remote AP on a per-role or per-user basis.
Protection against DHCP address exhaustion attack	This feature checks the frame's source-MAC against the DHCPv4 client hardware address and drops the packet if it does not match. This prevents a client from submitting multiple DHCP requests with different hardware addresses, which can deplete the DHCP pool.
L3 Mobility Support in VRF Environments	The L2-GRE Tunnel implementation of the IP mobility functionality is supported only on ArubaOS versions 6.2 or later and is not backward compatible with the earlier implementation. ArubaOS supports only v4 mobility and does not support IPv6 L3 mobility.

Feature	Description
Provisioning 802.11n APs for Single-Chain Transmission	AP radios in single-chain mode will transmit and receive data using only legacy rates and single-stream HT rates up to MCS 7. This setting is disabled by default.
Intelligent ARM Scanning at dynamic time intervals	If the AP does not have any associated clients (or if most of its clients are inactive) the ARM feature can dynamically readjust its default scan interval, allowing the AP obtain better information about its RF neighborhood by scanning non-home channels more frequently. Starting with ArubaOS 6.2, if an AP attempts to scan a non-home channel but is unsuccessful, the AP will make additional attempts to rescan that channel before skipping it and continuing on to other channels.
Spectrum enhancements: <ul style="list-style-type: none"> • Spectrum Analysis for 5Ghz band as a single slice • RFPlayback utility • Increased device support 	<ul style="list-style-type: none"> • Spectrum monitor radios can now monitor the entire 5 GHz radio band at once, allowing you to view spectrum data for the upper, middle, or lower portions of the 5 GHz band using a single radio. In previous releases, a spectrum monitor radio could monitor just one portion of the 5GHz radio band at any time. • You can view recordings using the RFPlayback tool available for download from the Dell web site. This tool can play spectrum recordings created in this and earlier versions of ArubaOS. Dell uses the Adobe AIR application to display spectrum recording information. • In ArubaOS 6.2, radios on W-AP104 and W-AP93H devices can be configured as spectrum monitors, and W-AP105 radios can be configured as either a spectrum monitor or a hybrid AP.
Policy Enforcement Firewall (PEF) Visibility	<p>The Policy Enforcement Firewall (PEF) Visibility is a new PEF feature on the ArubaOS controller. It enables network administrators to monitor the applications running and the users using them in a given network.</p> <p>The Dashboard page of the WebUI now has a new Firewall page. This page displays the PEF summary of all the sessions in the controller aggregated by users, devices, destinations, applications, WLANs, and roles.</p>
Instant AP VPN Support	Dell PowerConnect W-Series ArubaOS 6.2 provides an ability to terminate VPN and GRE tunnels from Instant AP and provide corporate connectivity to the branch Instant AP network.
Timestamps in CLI Output	The timestamp feature can include a timestamp in the output of each show command issued in the command-line interface, indicating the date and time the command was issued.
RAP 3G/4G Backhaul Link Quality Monitoring	The RAP is enhanced to support link monitoring on 2G, 3G, and 4G modems to provide information about the state of USB modem and cellular network.
IAP to RAP Mode Conversion	An Instant AP can now be provisioned as a Campus AP (CAP) or a Remote AP (RAP) in a controller-based network.
Captive Portal Enhancements	This release of ArubaOS introduces enhancements to the captive portal feature.
WMM-DSCP Mapping Enhancements	The WMM-DSCP mapping functionality has been enhanced to retain the original DSCP value.
LCD Screen and USB Port	The new W-7200 Series Controller includes an LCD Screen for basic configuration. Additionally, the W-7200 Series is equipped with a USB drive that can be used for loading a configuration and upgrading the controller's software.

Table 2: *New Hardware Platforms introduced with ArubaOS 6.2*

Feature	Description
Dell W-7200 Series Series Controller	The W-7200 Series Controller deliver a wide range of network services to large campus networks. The W-7200 Series supports up to 32,000 users and performs stateful firewall policy enforcement at speeds up to 40 Gbps.
W-IAP108 and W-IAP109 Remote Access Points	The W-IAP108 and W-IAP109 are dual-radio, dual-band remote access points that supports the IEEE 802.11n standard for high-performance WLAN. The W-IAP108 and W-IAP109 ship with Dell Instant software. Therefore, out of the box, the device will operate as a Virtual Controller (VC) or an Instant AP. However, the W-IAP108 and W-IAP109 can be converted to operate as a Remote AP (RAP). For more information about the IAP Conversion process, see Converting an IAP to RAP or CAP .
W-IAP3WN and W-IAP3WNP Remote Access Point	The W-IAP3WN and W-IAP3WNP are dual-radio, dual-band remote access points that supports the IEEE 802.11n standard for high-performance WLAN. The W-IAP3WN and W-IAP3WNP ship with Dell Instant software. Therefore, out of the box, the device will operate as a Virtual Controller (VC) or an Instant AP. However, the W-IAP3WN and W-IAP3WNP can be converted to operate as a Remote AP (RAP). For more information about the IAP Conversion process, see Converting an IAP to RAP or CAP .

Fundamentals

Configure your controller and AP using either the Web User Interface (WebUI) or the command line interface (CLI).

WebUI

Each controller supports up to 22 simultaneous WebUI connections. The WebUI is accessible through a standard Web browser from a remote management console or workstation. The WebUI includes configuration wizards that step you through easy-to-follow configuration tasks. The wizards are:

- AP Wizard—basic AP configuration
- Controller Wizard—basic controller configuration
- LAN Wizard—creating and configuring new WLAN(s) associated with the “default” ap-group
- License Wizard—installation and activation of software licenses

In addition to the wizards, the WebUI includes a Dashboard monitoring feature that provides enhanced visibility into your wireless network’s performance and usage. This allows you to easily locate and diagnose WLAN issues. For details on the WebUI Dashboard, see [Dashboard Monitoring](#).

CLI

The CLI is a text-based interface accessible from a local console connected to the serial port on the controller or through a Telnet or Secure Shell (SSH) session.



NOTE: By default, you access the CLI from the serial port or from an SSH session. You must explicitly enable Telnet on your controller in order to access the CLI via a Telnet session.

When entering commands remember that:

- commands are not case sensitive
- the space bar will complete your partial keyword

- the backspace key will erase your entry one letter at a time
- the question mark (?) will list available commands and options

Related Documents

The following items are part of the complete documentation for the Dell user-centric network:

- *Dell PowerConnect W-Series Controller Installation Guides*
- *Dell PowerConnect W-Series Access Point Installation Guides*
- *Dell PowerConnect W-Series ArubaOS Quick Start Guide*
- *Dell PowerConnect W-Series ArubaOS User Guide*
- *Dell PowerConnect W-Series ArubaOS Command Line Reference Guide*
- *Dell PowerConnect W-Series ArubaOS MIB Reference Guide*
- *Dell PowerConnect W-Series ArubaOS Release Notes*

Conventions

The following conventions are used throughout this manual to emphasize important concepts:

Table 3: Typographical Conventions

Type Style	Description
<i>Italics</i>	This style is used to emphasize important terms and to mark the titles of books.
System items	This fixed-width font depicts the following: <ul style="list-style-type: none"> • Sample screen output • System prompts • Filenames, software devices, and specific commands when mentioned in the text
Commands	In the command examples, this bold font depicts text that you must type exactly as shown.
<Arguments>	In the command examples, italicized text within angle brackets represents items that you should replace with information appropriate to your specific situation. For example: # send <text message> In this example, you would type "send" at the system prompt exactly as shown, followed by the text of the message you wish to send. Do not type the angle brackets.
[Optional]	Command examples enclosed in brackets are optional. Do not type the brackets.
{Item A Item B}	In the command examples, items within curled braces and separated by a vertical bar represent the available choices. Enter only one choice. Do not type the braces or bars.

The following informational icons are used throughout this guide:



NOTE: Indicates helpful suggestions, pertinent information, and important things to remember.



CAUTION: Indicates a risk of damage to your hardware or loss of data.



WARNING: Indicates a risk of personal injury or death.

Chapter 4

The Basic User-Centric Networks

This chapter describes how to connect a Dell controller and Dell AP to your wired network. After completing the tasks described in this chapter, see ["Access Points \(APs\)" on page 393](#) for information on configuring APs.

This chapter describes the following topics:

- ["Configuring Your User-Centric Network" on page 77](#)
- ["Understanding Basic Deployment and Configuration Tasks" on page 66](#)
- ["Configuring the Controller" on page 69](#)
- ["Configuring a VLAN to Connect to the Network" on page 73](#)
- ["Enabling Wireless Connectivity" on page 77](#)

Understanding Basic Deployment and Configuration Tasks

This section describes typical deployment scenarios and the tasks you must perform while connecting to a Dell controller and Dell AP to your wired network. For details on performing the tasks mentioned in these scenarios, refer to the other procedures within the **Basic User-Centric Networks** section of this document.

Deployment Scenario #1: Controller and APs on Same Subnet

Figure 4: *Controller and APs on Same Subnet*

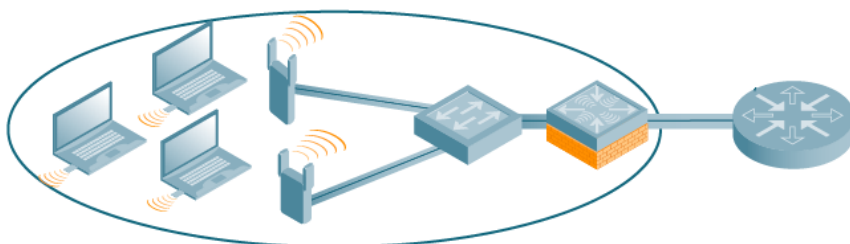

In this deployment scenario, the APs and controller are on the same subnetwork and will use IP addresses assigned to the subnetwork. The router is the default gateway for the controller and clients. There are no routers between the APs and the controller. APs can be physically connected directly to the controller. The uplink port on the controller is connected to a layer-2 switch or router.

For this scenario, you must perform the following tasks:

1. Run the initial setup wizard.
 - Set the IP address of VLAN 1.
 - Set the default gateway to the IP address of the interface of the upstream router to which you will connect the controller.
2. Connect the uplink port on the controller to the switch or router interface. By default, all ports on the controller are access ports and will carry traffic for a single VLAN.
3. Deploy APs. The APs will use the Aruba Discovery Protocol (ADP) to locate the controller.

4. Configure the SSID(s) with VLAN 1 as the assigned VLAN for all users.

Deployment Scenario #2: APs All on One Subnet Different from Controller Subnet

Figure 5: APs All on One Subnet Different from Controller Subnets

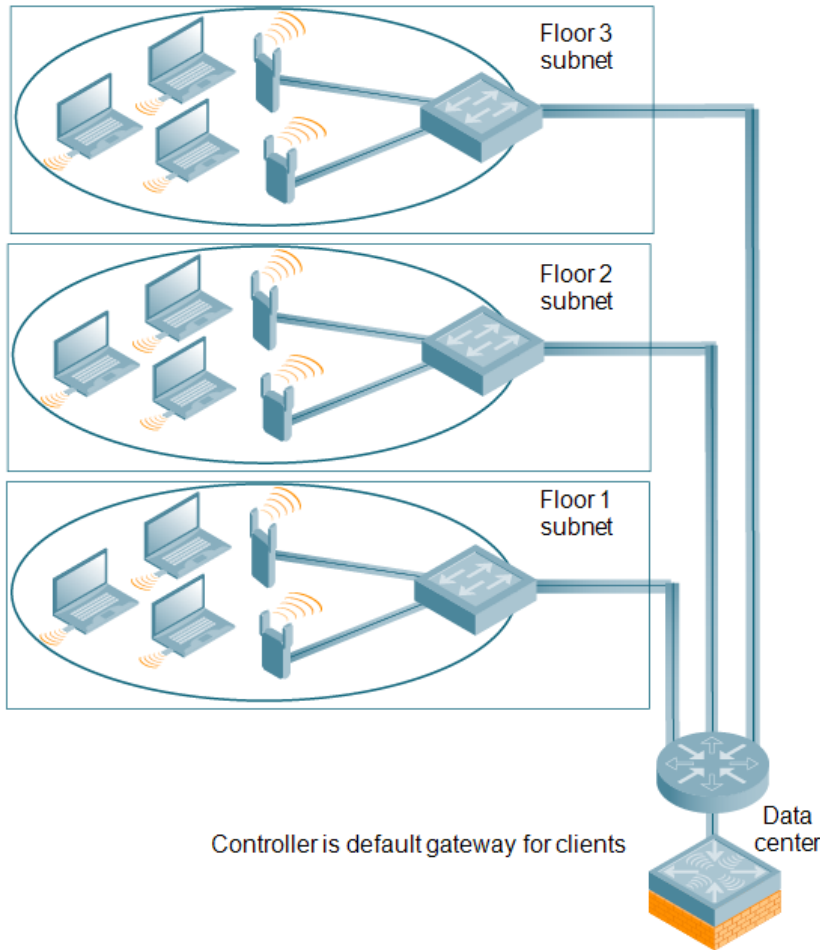

In this deployment scenario, the APs and the controller are on different subnetworks and the APs are on multiple subnetworks. The controller acts as a router for the wireless subnetworks (the controller is the default gateway for the wireless clients). The uplink port on the controller is connected to a layer-2 switch or router; this port is an access port in VLAN 1.

For this scenario, you must perform the following tasks:

1. Run the initial setup wizard.
 - Set the IP address for VLAN 1.
 - Set the default gateway to the IP address of the interface of the upstream router to which you will connect the controller.
2. Connect the uplink port on the controller to the switch or router interface.
3. Deploy APs. The APs will use DNS or DHCP to locate the controller.
4. Configure VLANs for the wireless subnetworks on the controller.
5. Configure SSIDs with the VLANs assigned for each wireless subnetwork.



NOTE: Each wireless client VLAN must be configured on the controller with an IP address. On the uplink switch or router, you must configure static routes for each client VLAN, with the controller's VLAN 1 IP address as the next hop.

Deployment Scenario #3: APs on Multiple Different Subnets from Controllers

Figure 6: APs on Multiple Different Subnets from Controllers

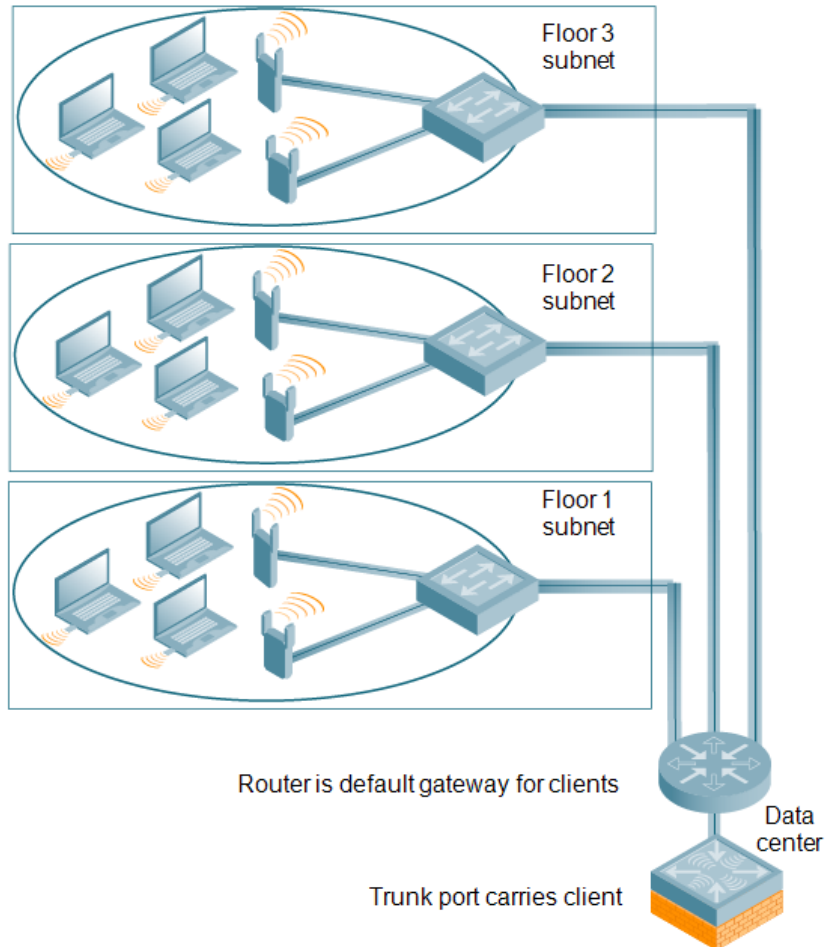

In this deployment scenario, the APs and the controller are on different subnetworks and the APs are on multiple subnetworks. There are routers between the APs and the controller. The controller is connected to a layer-2 switch or router through a trunk port that carries traffic for all wireless client VLANs. An upstream router functions as the default gateway for the wireless users.



NOTE: This deployment scenario does *not* use VLAN 1 to connect to the layer-2 switch or router through the trunk port. The initial setup prompts you for the IP address and default gateway for VLAN 1; use the default values. In later steps, you configure the appropriate VLAN to connect to the switch or router as well as the default gateway.

For this scenario, you must perform the following tasks:

1. Run the initial setup.
 - Use the *default* IP address for VLAN 1. Since VLAN 1 is *not* used to connect to the layer-2 switch or router through the trunk port, you must configure the appropriate VLAN in a later step.
 - Do *not* specify a default gateway (use the default “none”). In a later step, you configure the default gateway.

2. Create a VLAN that has the same VLAN ID as the VLAN on the switch or router to which you will connect the controller. Add the uplink port on the controller to this VLAN and configure the port as a trunk port.
3. Add client VLANs to the trunk port.
4. Configure the default gateway on the controller. This gateway is the IP address of the router to which you will connect the controller.
5. Configure the loopback interface for the controller.
6. Connect the uplink port on the controller to the switch or router interface.
7. Deploy APs. The APs will use DNS or DHCP to locate the controller.
8. Now configure VLANs on the controller for the wireless client subnetworks and configure SSIDs with the VLANs assigned for each wireless subnetwork.

Configuring the Controller

The tasks in deploying a basic user-centric network fall into two main areas:

- Configuring and connecting the controller to the wired network (described in this section)
- Deploying APs (described later in this section)

To connect the controller to the wired network:

1. Run the initial setup to configure administrative information for the controller.
Initial setup can be done using the browser-based Setup Wizard or by accessing the initial setup dialog via a serial port connection. Both methods are described in the *Dell PowerConnect W-Series ArubaOS Quick Start Guide* and are referred to throughout this *chapter* as “initial setup.”
2. (Deployment #3) Configure a VLAN to connect the controller to your network. You do *not* need to perform this step if you are using VLAN 1 to connect the controller to the wired network.
3. (Optional) Configure a loopback address for the controller. You do *not* need to perform this step if you are using the VLAN 1 IP address as the controller’s IP address. Disable spanning tree on the controller if necessary.
4. Configure the system clock.
5. (Optional) Install licenses; refer to [Software Licenses on page 100](#).
6. Connect the ports on the controller to your network.

This section describes the steps in detail.

Running Initial Setup

When you connect to the controller for the first time using either a serial console or a Web browser, the initial setup requires you to set the role (master or local) for the controller and passwords for administrator and configuration access.



NOTE: Do not connect the controller to your network when running the initial setup. The factory-default controller boots up with a default IP address and both DHCP server and spanning tree functions are not enabled. Once you have completed the initial setup, you can use either the CLI or WebUI for further configuration before connecting the controller to your network.

The initial setup might require that you specify the country code for the country in which the controller will operate; this sets the regulatory domain for the radio frequencies that the APs use.



NOTE: You cannot change the country code for Dell controllers designated for certain countries, such as the U.S. Improper country code assignment can disrupt wireless transmissions. Many countries impose penalties and sanctions for operators of wireless networks with devices set to improper country codes. If none of the channels supported by the AP you are provisioning have received regulatory approval by the country whose country code you selected, the AP will revert to Air Monitor mode.

The initial setup requires that you configure an IP address for the VLAN 1 interface, which you can use to access and configure the controller remotely via an SSH or WebUI session. Configuring an IP address for the VLAN 1 interface ensures that there is an IP address and default gateway assigned to the controller upon completion of the initial setup.

Connecting to the Controller after Initial Setup

After you complete the initial setup, the controller reboots using the new configuration. (See the *Dell PowerConnect W-Series ArubaOS Quick Start Guide* for information about using the initial setup.) You can then connect to and configure the controller in several ways using the administrator password you entered during the initial setup:

- You can continue to use the connection to the serial port on the controller to enter the command line interface (CLI). (Refer to [Management Access on page 625](#) for information on how to access the CLI and enter configuration commands.)
- You can connect an Ethernet cable from a PC to an Ethernet port on the controller. You can then use one of the following access methods:
 - Use the VLAN 1 IP address to start an SSH session where you can enter CLI commands.
 - Enter the VLAN 1 IP address in a browser window to start the WebUI.
 - WebUi Wizards.

NOTE: This chapter and the user guide in general focus on CLI and standard WebUI configuration examples. However, basic controller configuration and WLAN/LAN creation can be completed using the alternative wizards from within the WebUI. If you wish to use a configuration wizard, navigate to **Configuration > Wizards**, click on the desired wizard, and follow the imbedded help instructions within the wizard.

Dell W-7200 Series Controller

The Dell W-7200 Series controller is a new controller platform that is introduced in conjunction with ArubaOS 6.2. This controller provides new functionality and improved capabilities over previous Dell controllers. However, the W-7200 Series also introduces some changes that you must keep in mind when adding it to your network.

New Port Numbering Scheme

The W-7200 Series uses a different port numbering scheme from previous Dell controllers. All other controller platforms use a **slot/port** numbering scheme. The W-7200 Series uses **slot/module/port** instead.

It is important to consider this when migrating an older controller to the W-7200 Series. If you load a configuration from a non-W-7200 Series controller, that controller will not have network connectivity because any interface configuration will not be recognized. For information about migrating to a W-7200 Series controller, see the *Dell PowerConnect W-Series ArubaOS 6.2 Release Notes* or visit dell.com/support.

Individual Port Behavior

The first two ports on the W-7200 Series, 0/0/0 and 0/0/1 are combination ports and can be used for management, HA, and I/O. ports 0/0/2 through 0/0/5 can only be used for I/O. Keep this in mind when configuring your ports.

Using the LCD Screen

NOTE: The LCD Screen and its related commands are only available on the W-7200 Series Controller.

The W-7200 Series Controller is equipped with an LCD panel that displays a variety of information about the controller's status and provides a menu that allows for basic operations such as initial setup and reboot. The LCD panel displays two lines of text with a maximum of 16 characters on each line. When using the LCD panel, the active line is indicated by an arrow next to the first letter.

The LCD panel is operated using the two navigation buttons to the left of the screen.

- Menu: Allows you to navigate through the menus of the LCD panel.
- Enter: Confirms and executes the action currently displayed on the LCD panel.

The LCD has four modes:

- Boot: Displays the boot up status.
- LED Mode: Displays the mode that the STATUS LED is in.
- Status: Displays the status of different components of the W-7200 Series, including Power Supplies and ArubaOS version.
- Maintenance: Allows you to execute some basic operations of the W-7200 Series such as uploading an image or rebooting the system.

Table 7: LCD Panel Mode: Boot

Function/Menu Options	Displays
Displays boot status	"Booting ArubaOS..."

Table 8: LCD Panel Mode: LED Mode

Function/Menu Options	Displays
Administrative	LED MODE: ADM - displays whether the port is administratively enabled or disabled.
Duplex	LED MODE: DPX - displays the duplex mode of the port.
Speed	LED MODE: SPD - displays the speed of the port.
Exit Idle Mode	EXIT IDLE MENU

Table 9: LCD Panel Mode: Status

Function/Menu Options	Displays
ArubaOS	Version ArubaOS X.X.X.X
PSU	Status Displays status of the power supply unit. PSU 0: [OK FAILED MISSING] PSU 1: [OK FAILED MISSING]
Fan Tray	Displays fan tray status. FAN STATUS: [OK ERROR MISSING] FAN TEMP: [OK HIGH SHUTDOWN]
Exit Status Menu	EXIT STATUS

Table 10: LCD Panel Mode: Maintenance

Function/Menu Options	Displays
Upgrade Image	Upgrade the software image on the selected partition from a predefined location on the attached USB flash device. Partition [0 1] Upgrade Image [no yes]
Upload Config	Uploads the controller's current configuration to a predefined location on the attached USB flash device. Upload Config [no yes]
Factory Default	Allows you to return the controller to the factory default settings. Factory Default [no yes]
Media Eject	Completes the reading or writing of the attached USB device. Media Eject [no yes]
System Reboot	Allows you to reboot the controller. Reboot [no yes]
System Halt	Allows you to halt the controller. Halt [no yes]
Exit Maintenance Menu	EXIT MAINTENANCE

Using the LCD and USB Drive

You can upgrade your image or upload your pre-saved configuration by using your USB drive and your LCD commands.

Upgrading an Image

1. Copy a new controller image onto your USB drive into a directory named `/dellimage`.
2. Insert your USB drive into the controller's USB slot. Wait for 30 seconds for the controller to mount the USB.
3. Navigate to Upgrade Image in the LCD's Maintenance menu. Select partition and confirm the upgrade (Y/N) and then wait for controller to copy the image from USB to the system partition.
4. Execute a system reboot either from the LCD menu or from the command line to complete the upgrade.

Uploading a Pre-saved Configuration

1. Copy your pre-saved configuration and name the copied file `dell_usb.cfg`.
2. Move your pre-saved configuration file onto your USB drive into a directory named `/dellimage`.
3. Insert your USB drive into the controller's USB slot. Wait for 30 seconds for the controller to mount the USB.
4. Navigate to the Upload Config in the LCD's Maintenance menu. Confirm the upload (Y/N) and then wait for the upload to complete.
5. Execute a system reboot either from the LCD menu or from the command line to reload from the uploaded configuration.

For detailed upgrade and upload instruction, see the Upgrade Chapter in the Release Notes.

Disabling LCD Menu Functions

For security purpose, you can disable all LCD menu functions by disabling the entire menu functionality using the following command:

```
(host) (config) #lcd-menu
(host) (lcd-menu) #disable menu
```

To prevent inadvertent menu changes, you can disable LCD individual menu function using the following commands:

```
(host) (lcd-menu) #disable menu maintenance ?
  factory-default Disable factory default menu
  media-eject Disable media eject menu on LCD
  system-halt Disable system halt menu on LCD
  system-reboot Disable system reboot menu on LCD
  upgrade-image Disable image upgrade menu on LCD
  upload-config Disable config upload menu on LCD
```

To display the current LCD functionality from the command line, use the following command:

```
(host) (config) #show lcd-menu
lcd-menu
-----
Parameter                               Value
-----
menu maintenance upgrade-image partition0  enabled
menu maintenance upgrade-image partition1  enabled
menu maintenance upgrade-image            enabled
menu maintenance upload-config            enabled
menu maintenance factory-default          enabled
menu maintenance media-eject              enabled
menu maintenance reload-system             enabled
menu maintenance halt-system              enabled
menu maintenance                          enabled
menu                                       enabled
```

Configuring a VLAN to Connect to the Network

You must follow the instructions in this section only if you need to configure a trunk port between the controller and another layer-2 switch (shown in ["Deployment Scenario #3: APs on Multiple Different Subnets from Controllers" on page 68](#)).

This section shows how to use both the WebUI and CLI for the following configurations (subsequent steps show how to use the WebUI only):

- Create a VLAN on the controller and assign it an IP address.
- Optionally, create a VLAN pool. A VLAN pool consists of two more VLAN IDs which are grouped together to efficiently manage multi-controller networks from a single location. For example, policies and virtual application configurations map users to different VLANs which may exist at different Dell controllers. This creates redundancy where one controller has to back up many other Dell controllers. With the VLAN pool feature you can control your configuration globally.



NOTE: VLAN pooling should *not* be used with static IP addresses.

- Assign to the VLAN the ports that you will use to connect the controller to the network. (For example, the uplink ports connected to a router are usually Gigabit ports.) In the example configurations shown in this section, a controller is connected to the network through its Gigabit Ethernet port 1/25.

- Configure the port as a trunk port.
- Configure a default gateway for the controller.

Creating, Updating, and Viewing VLANs and Associated IDs

You can create and update a single VLAN or bulk VLANs using the WebUI or the CLI. See ["Creating and Updating VLANs" on page 108](#).



NOTE: In the WebUI configuration windows, clicking the **Save Configuration** button saves configuration changes so they are retained after the controller is rebooted. Clicking the **Apply** button saves changes to the running configuration but the changes are not retained when the controller is rebooted. A good practice is to use the **Apply** button to save changes to the running configuration and, after ensuring that the system operates as desired, click **Save Configuration**.

You can view VLAN IDs in the CLI.

```
(host) #configure terminal
Enter Configuration commands, one per line. End with CNTL/Z
(host) (config) #show vlan
```

```
VLAN CONFIGURATION
-----
VLAN   Description   Ports
-----
1       Default       FE1/0-3 FE1/6 GE1/8
2       VLAN0002
4       VLAN0004
12      VLAN0012
210     VLAN0210
212     VLAN0212      FE1/5
213     VLAN0213      FE1/4
1170    VLAN1170      FE1/7
```

Creating, Updating, and Deleting VLAN Pools



NOTE: VLAN pooling should *not* be used with static IP addresses.

You can create, update, and delete a VLAN pool using the WebUI or the CLI. See ["Creating a VLAN Pool" on page 110](#).

Use the CLI to add existing VLAN IDs to a pool.

```
(host) #configure terminal
Enter Configuration commands, one per line. End with CNTL/Z
(host) (config) #vlan-name mygroup pool
(host) (config) #vlan mygroup 2,4,12
(host) (config) #
```

To confirm the VLAN pool status and mappings assignments, use the `show vlan mapping` command:

```
(host) (config) #show vlan mapping
VLAN Name                               Pool Status   VLAN IDs
-----
mygroup                                  Enabled       2,4,12
group123                                  Disabled
```

Assigning and Configuring the Trunk Port

The following procedures configures a Gigabit Ethernet port as trunk port.

In the WebUI

1. Navigate to the **Configuration > Network > Ports** window on the WebUI.
2. In the Port Selection section, click the port that will connect the controller to the network. In this example, click port 25.
3. For Port Mode, select **Trunk**.
4. For Native VLAN, select VLAN 5 from the scrolling list, then click the left (<-->) arrow.
5. Click **Apply**.

In the CLI

```
interface gigabitethernet 1/25
  switchport mode trunk
  switchport trunk native vlan 5
```

To confirm the port assignments, use the **show vlan** command:

```
(host) (config) #show vlan

VLAN CONFIGURATION
-----
VLAN    Name            Ports
----    -
1       Default         Fa1/0-23 Gig1/24
5       VLAN0005        Gig1/25
```

Configuring the Default Gateway

The following configurations assign a default gateway for the controller.

In the WebUI

1. Navigate to the **Configuration > Network > IP > IP Routes** window.
2. To add a new static gateway, click the **Add** button below the static IP address list.
 - a. In the **IP Address** field, enter an IP address in dotted-decimal format.
 - b. In the **Cost** field, enter a value for the path cost.
 - c. Click **Add**.
3. You can define a dynamic gateway using DHCP, PPPOE or a cell uplink interface. In the **Dynamic** section, click the **DHCP**, **PPPoE** or **Cellular** checkboxes to select one or more dynamic gateway options. If you select more than one dynamic gateway type, you must also define a cost for the route to each gateway. The controller will first attempt to obtain a gateway IP address using the option with the lowest cost. If the controller is unable to obtain a gateway IP address, it will then attempt to obtain a gateway IP address using the option with the next-lowest path cost.
4. Click **Apply**.

In the CLI

```
ip default-gateway <ipaddr>|{import cell|dhcp|pppoe}|{ipsec <name>} <cost>
```

Configuring the Loopback IP Address for the Controller

You must configure a loopback address if you are not using a VLAN ID address to connect the controller to the network (see ["Deployment Scenario #3: APs on Multiple Different Subnets from Controllers" on page 68](#)).



NOTE: After you configure or modify a loopback address, you must reboot the controller.

If configured, the loopback address is used as the controller's IP address. If you do not configure a loopback address for the controller, the IP address assigned to the first configured VLAN interface IP address. Generally, VLAN 1 is configured first and is used as the controller's IP address.

ArubaOS allows the loopback address to be part of the IP address space assigned to a VLAN interface. In the example topology, the VLAN 5 interface on the controller was previously configured with the IP address 10.3.22.20/24. The loopback IP address in this example is 10.3.22.220.



NOTE: You configure the loopback address as a host address with a 32-bit netmask. The loopback address should be routable from all external networks.

Spanning tree protocol (STP) is enabled by default on the controller. STP ensures a single active path between any two network nodes, thus avoiding bridge loops. Disable STP on the controller if you are not employing STP in your network.

In the WebUI

1. Navigate to the **Configuration > Network > Controller > System Settings** window.
2. Enter the IP address under Loopback Interface.
3. On this window, you can also turn off spanning tree. Click **No** for Spanning Tree Enabled.
4. Click **Apply** at the bottom of the window (you might need to scroll down the window).
5. At the top of the window, click **Save Configuration**. Note that you must reboot the controller for the new IP address to take effect.
6. Navigate to the **Maintenance > Controller > Reboot Controller** window.
7. Click **Continue**.

In the CLI

```
interface loopback ip address 10.3.22.220
no spanning-tree
write memory
reload
```

The controller returns the following messages:

```
Do you really want to reset the system(y/n):
```

Enter **y** to reboot the controller or **n** to cancel.

```
System will now restart!
...
Restarting system.
```

To verify that the controller is accessible on the network, ping the loopback address from a workstation on the network.

Configuring the System Clock

You can manually set the clock on the controller, or configure the controller to use a Network Time Protocol (NTP) server to synchronize its system clock with a central time source. For more information about setting the controller's

clock, see ["Setting the System Clock" on page 660](#).

Installing Licenses

ArubaOS consists of a base operating system with optional software modules that you can activate by installing license keys. If you use the Setup Wizard during the initial setup phase, you will have the opportunity to install software licenses at that time. Refer to [Software Licenses on page 100](#) for detailed information on Licenses.

Connecting the Controller to the Network

Connect the ports on the controller to the appropriately-configured ports on an L2 switch or router. Make sure that you have the correct cables and that the port LEDs indicate proper connections. Refer to the *Installation Guide* for the controller for port LED and cable descriptions.



NOTE: In many deployment scenarios, an external firewall is situated between various Dell devices. [External Firewall Configuration on page 507](#) describes the network ports that must be configured on the external firewall to allow proper operation of the network.

To verify that the controller is accessible on the network:

- If you are using VLAN 1 to connect the controller to the network ("[Deployment Scenario #2: APs All on One Subnet Different from Controller Subnet](#)" on page 67 and "[Deployment Scenario #3: APs on Multiple Different Subnets from Controllers](#)" on page 68), ping the VLAN 1 IP address from a workstation on the network.
- If you created and configured a new VLAN ("[Deployment Scenario #3: APs on Multiple Different Subnets from Controllers](#)" on page 68), ping the IP address of the new VLAN from a workstation on the network.

Enabling Wireless Connectivity

Wireless users can connect to the SSID but because you have not yet configured authentication, policies, or user roles, they will not have access to the network. Other chapters in the *Dell PowerConnect W-Series ArubaOS User Guide* describe how to build upon this basic deployment to configure user roles, firewall policies, authentication, authentication servers, and other wireless features.

Configuring Your User-Centric Network

Configuring your controller and AP is done through either the Web User Interface (WebUI) or the command line interface (CLI).

- WebUI is accessible through a standard Web browser from a remote management console or workstation. The WebUI includes configuration wizards that step you through easy-to-follow configuration tasks. Each wizard has embedded online help. The wizards are:
 - AP Wizard—basic AP configurations including LAN, Remote, LAN Mesh and Remote Mesh deployment scenarios
 - Controller Wizard—basic controller configuration including system settings, Control Plane security, cluster settings and licenses
 - WLAN/LAN Wizard—creating and configuring new WLANs and LANs associated with the “default” ap-group. Includes campus only and remote networking.
 - License Wizard—installation and activation of software licenses (see [Software Licenses on page 100](#))



NOTE: Clicking **Cancel** from the Wizards return you to where you launched the wizard. Any configuration changes you entered are not saved.

- The command line interface (CLI) allows you to configure and manage Dell controllers. The CLI is accessible from a local console connected to the serial port on the controller or through a Telnet or Secure Shell (SSH) session from a remote management console or workstation.



NOTE: By default, you can only access the CLI from the serial port or from an SSH session. To use the CLI in a Telnet session, you must explicitly enable Telnet on the controller.

Chapter 5

Control Plane Security

ArubaOS supports secure IPsec communications between a controller and campus or remote APs using public-key self-signed certificates created by each master controller. The controller certifies its APs by issuing them certificates. If the master controller has any associated local Dell controllers, the master controller sends a certificate to each local controller, which in turn sends certificates to their own associated APs. If a local controller is unable to contact the master controller to obtain its own certificate, it is not be able to certify its APs, and those APs can not communicate with their local controller until master-local communication has been reestablished. You create an initial control plane security configuration when you first configure the controller using the initial setup wizard. The ArubaOS initial setup wizard enables control plane security by default, so it is very important that the local controller is able to communicate with its master controller when it is first provisioned.

Some AP model types have factory-installed digital certificates. These AP models use their factory-installed certificates for IPsec, and do not need a certificate from the controller. Once a campus or remote AP is certified, either through a factory-installed certificate or a certificate from the controller, the AP can failover between local Dell controllers and still stay connected to the secure network, because each AP has the same master controller as a common trust anchor.

Starting with ArubaOS 6.2, the controller maintains two separate AP whitelists; one for campus APs and one for Remote APs. These whitelists contain records of all campus APs or remote APs connected to the network. You can use a campus or AP whitelist at any time to add anew valid campus or remote AP to the secure network, or revoke network access to any suspected rogue or unauthorized AP.



NOTE: The control plane security feature supports IPv4 campus and remote APs only Do not enable control plane security on a controller that terminates IPv6 APs.

When the controller sends an AP a certificate, that AP must reboot before it can connect to its controller over a secure channel. If you are enabling control plane security for the first time on a large network, you may experience several minutes of interrupted connectivity while each AP receives its certificate and establishes its secure connection.

Topics in this chapter include:

- ["Control Plane Security Overview" on page 80](#)
- ["Configuring Control Plane Security" on page 80](#)
- ["Managing Whitelists on Master and Local Controllers" on page 87](#)
- ["Working in Environments with Multiple Master Controllers" on page 90](#)
- ["Replacing a Controller on a Multi-Controller Network" on page 93](#)
- ["Configuring Control Plane Security after Upgrading" on page 97](#)
- ["Troubleshooting Control Plane Security" on page 97](#)

Control Plane Security Overview

Controllers using control plane security only send certificates to APs that you have identified as valid APs on the network. If you want closer control over each AP that gets certified, you can manually add individual campus and remote APs to the secure network by adding each AP's information to the whitelists when you first run the initial setup wizard. If you are confident that all APs currently on your network are valid APs, then you can use the initial setup wizard to configure automatic certificate provisioning to send certificates from the controller to each campus or remote AP, or to all campus and remote APs within specific ranges of IP addresses.

The default automatic certificate provisioning setting requires that you manually enter each campus AP's information into the campus AP whitelist, and each remote APs information into the remote AP whitelist. If you change the default automatic certificate provisioning values to let the controller send certificates to all APs on the network, that new setting ensures that all valid APs receive a certificate, but also increases the chance that a rogue or unwanted AP is also certified. If you configure the controller to send certificates to only those APs within a range of IP addresses, there is a smaller chance that a rogue AP gets a certificate, but any valid AP with an IP address outside the specified address ranges will not get a certificate and can not communicate with the controller (except to obtain a certificate). Consider both options carefully before you complete the control plane security portion of the initial setup wizard. If your controller has a publicly accessible interface, you should identify the APs on the network by IP address range. This prevents the controller from sending certificates to external or rogue campus APs that may attempt to access your controller through that publicly accessible interface.

Configuring Control Plane Security

When you initially deploy the controller, you create your initial control plane security configuration using the initial setup wizard. These settings can be changed at any time using the WebUI or the command-line interfaces.



NOTE: If you are configuring control plane security for the first time after upgrading from ArubaOS 5.0 or earlier, see "[Configuring Control Plane Security after Upgrading](#)" on page 97 for details on enabling this feature using the WebUI or CLI.

In the WebUI

1. Access the WebUI of a standalone or master controller, and navigate to **Configuration > Network > Controller**.
2. Select the **Control Plane Security** tab.
3. Configure the following control plane security parameters.

Table 11: Control Plane Security Parameters

Parameter	Description
Control Plane Security	Select enable or disable to turn the control plane security feature on or off. This feature is enabled by default.
Auto Cert Provisioning	When the control plane security feature is enabled, you can select this checkbox to turn on automatic certificate provisioning. When this feature is enabled, the controller attempts to send certificates to all associated campus APs. Auto certificate provisioning is disabled by default. NOTE: If you do not want to enable automatic certificate provisioning the first time you enable control plane security on the controller, you must identify the valid APs on your network by adding those to the campus AP whitelist. For details, see " Viewing and Managing the Master or Local Switch Whitelists " on page 88. After you have enabled automatic certificate provisioning, you must select either Auto Cert Allow all or Addresses Allowed for Auto Cert .
Addresses allowed for	The Addresses Allowed for Auto Cert section allows you to specify ehter certificates should be

Parameter	Description
Auto Cert	<p>sent to all associated APs, or just APs within one or more specific IP address ranges. If your controller has a publicly accessible interface, you should identify your campus and Remote APs by IP address range. This prevents the controller from sending certificates to external or rogue campus APs that may attempt to access your controller through that interface.</p> <p>Select All to allow all associated campus and remote APs to receive automatic certificate provisioning. This parameter is enabled by default.</p> <p>Select Addresses Allowed for Auto Cert to send certificates to a group of campus or remote APs within a range of IP addresses. In the two fields below, enter the start and end IP addresses, then click Add. Repeat this procedure to add additional IP ranges to the list of allowed addresses. If both control plane security and auto certificate provisioning is enabled, all APs in the address list receives automatic certificate provisioning.</p> <p>Remove a range IP addresses from the list of allowed addresses by selecting the IP address range from the list and clicking Delete.</p>
Number of AP Whitelist Entries	The total number of APs in the remote AP and campus AP Whitelists. This number is also a link to a combined whitelist that displays all campus and remote AP entries.

4. Click **Apply** to save your changes.

The master controller generates its self-signed certificate and begins distributing certificates to campus APs and any local Dell controllers on the network over a clear channel. After all APs have received a certificate and have connected to the network using a secure channel, access the **Control Plane Security** window and turn off auto certificate provisioning if that feature was enabled. This prevents the controller from issuing a certificate to any rogue APs that may appear on your network at a later time.

Figure 12: Control Plane Security Settings

In the CLI

Use the following commands to configure control plane security via the command line interface on a standalone or master controller. Descriptions of the individual parameters are listed in [Table 11](#), above.

```
control-plane-security
  auto-cert-allow-all
  auto-cert-allowed-addr <ipaddress-start> <ipaddress-end>
  auto-cert-prov
  cpsec-enable
```

Example:

```
(host) (config) # control-plane-security
  auto-cert-prov
  no auto-cert-allow-all
  auto-cert-allowed-addr 10.21.18.10 10.21.10.90
```

View the current control plane security settings using the following command:

```
show control-plane-security
```

Managing AP Whitelists

Campus and Remote APs appear as valid APs in the campus and Remote AP whitelists when you manually enter their information into the whitelists via the controller's CLI or WebUI, or after the controller sends the AP a certificate via automatic certificate provisioning and the AP connects to its controller via a secure tunnel. Any APs not approved or certified on the network are also included in the whitelists, but these APs appear in an unapproved state.

Use the whitelists to grant valid APs secure access to the network, or to revoke access from suspected rogue APs. When you revoke or remove an AP from the campus or remote AP whitelist on a controller that uses control plane security, that AP is not able to communicate with the controller again, except to obtain a new certificate.

NOTE: If you manually add APs to the whitelists (rather than automatically adding the APs via the automatic certificate provisioning feature), make sure that the whitelists have been synchronized to all other Dell controllers on the network *before* enabling control plane security.

Adding APs to the Campus and Remote AP Whitelists

You can add an AP to the campus AP or remote AP whitelists via the WebUI or command-line interface. To add an entry via the WebUI, use the following procedure.

1. Access the WebUI, and navigate to **Configuration > Wireless > AP Installation**.
2. Click the **Whitelist** tab.
3. Select the whitelist to which you want to add the AP. By default, the Whitelist tab displays status information for the Campus AP Whitelist. To add a remote AP to the Remote AP whitelist, click the blue **Remote AP** link at the top of the table before you proceed to [step 4 on page 82](#).

Figure 13: Control Plane Security Settings



4. Click the **Entries** button in the upper right corner of the whitelist status window.
5. Click **New**.
6. Define the following parameters for each AP you want to add to the whitelist.

Table 14: AP Whitelist Parameters

Parameter	Description
Campus AP whitelist configuration parameters	
AP MAC Address	MAC address of a campus AP that should support secure communications to and from its controller.

Parameter	Description
Description	(Optional) Use this field to add a brief description of the campus AP.
Remote AP whitelist configuration parameters	
AP MAC Address	MAC address of the remote AP, in colon-separated octets.
User Name	Name of the end user who provisions and uses the remote AP.
AP Group	Select the name of the AP group to which the remote AP is assigned.
AP Name	(Optional) Name of the remote AP. If you not specify a name, the AP uses its MAC address as a name.
Description	(Optional) A brief description to help you identify the AP
IP-Address	The static inner IP address to be assigned to the remote APs.

- Click **Add** to add the information to the whitelist.
- Click **Apply** to save your changes.

To add an AP to the Campus AP whitelist via the command-line interface, issue the command

```
whitelist-db cpsec add mac-address <macaddr> description <description>
```

To add an AP to the Remote AP whitelist via the command-line interface, issue the command

```
whitelist-db rap add mac-address <macaddr> ap-group <ap-group> [ap-name <ap-name>]
[description <description>] [full-name <name>] remote-ip <inner-ip-adr>
```

Viewing Whitelist Status

The WebUI can display either a table of entries in the selected whitelist, or a general nstatus summary for that whitelist. The whitelist status pages show the current status each entry in the whitelist, and, for Dell controllers in a master/local controller topology, information for whitelist synchronization between Dell controllers. This information is updated automatically as the status of each entry changes.

By default, the **Wireless > AP Installation > Whitelist** tab displays status information for the campus AP Whitelist. To view status information for entries in the remote AP whitelist, click the blue **Remote AP** link on this tab.

The following table describes the status information types available on the Whitelist status page.

Table 15: *Whitelist status information*

Status Entry	Description
Control Plane Security (Campus AP Whitelist status only)	The Campus AP whitelist status page shows if control plane security has been enabled or disabled on the controller. This status entry is also a link to the control plane security configuration tab.
Number of Entries	Total number of entries in the selected whitelist.
Approved Entries	Number of entries that have been approved by the controller.
Unapproved Entries	Number of entries that have not been approved by the controller

Status Entry	Description
Certified Entries	AP has an approved certificate from the controller
Certified Hold Entries	An AP is put in this state when the controller thinks the AP has been certified with a factory certificate yet the AP requests to be certified again. Since this is not a normal condition, the AP is not approved as a secure AP until a network administrator manually changes the status of the AP to verify that it is not compromised. NOTE: If an AP is in this state due to connectivity problems, then the AP recovers and is taken out of this hold state as soon as connectivity is restored.
Revoked Entries	Number of AP entries that have been manually revoked.
Marked For Deletion Entries	Number of APs that have been marked for deletion, but that have not been removed from the whitelist.

The Remote AP whitelist entries page displays only the information manually configured by the network administrator. The entries in the campus AP whitelist include both user-defined settings and additional AP information that is updated as the status of the AP changes.

Table 16: *Additional Campus AP Status Information*

Parameter	Description
Cert Type	The type of certificate used by the AP. <ul style="list-style-type: none"> ● switch-cert: The AP is using a certificate signed by the controller. ● factory-cert: the AP is using a factory-installed certificate. This option should only be used for AP model types W-AP105, the W-AP120 Series and the W-AP130 Series.
State	The Campus AP Whitelist reports one of the following states for each campus AP: <ul style="list-style-type: none"> ● unapproved-no-cert: AP has no certificate and is not approved. ● unapproved-factory-cert: AP has a preinstalled certificate that was not approved. ● approved-ready-for-cert: The AP has been approved as a valid campus AP and is ready to receive a certificate. ● certified-factory-cert: The AP is already has a factory certificate. If an AP has the factory-cert certificate type and is in the certified-factory-cert state, then that campus AP is not re-issued a new certificate if automatic certificate provisioning is enabled. ● certified-switch-cert: AP has an approved certificate from the controller. ● certified-hold-factory-cert: An AP is put in this state when the controller thinks the AP has been certified with a factory certificate yet the AP requests to be certified again. Since this is not a normal condition, the AP is not approved as a secure AP until a network administrator manually changes the status of the AP to verify that it is not compromised. NOTE: If an AP is in this state due to connectivity problems, then the AP recovers and leaves this hold state as soon as connectivity is restored. ● certified-hold-switch-cert: An AP is put in this state when the controller thinks the AP has been certified with a controller certificate yet the AP requests to be certified again. Since this is not a normal condition, the AP is not approved as a secure AP until a network administrator manually changes the status of the AP to verify that it is not compromised. NOTE: If an AP is in this state due to connectivity problems, then the AP recovers and is taken out of this hold state as soon as connectivity is restored.
Revoked	Shows if the AP's secure status has been revoked.
Revoked Text	An optional, brief statement describing why the AP was revoked.
Last Update	Time and date of the last AP status update.

To view information about the remote and campus AP whitelists using the command-line interface, use the commands described in [Table 17](#).

Table 17: View the Campus AP Whitelist via the CLI

Command	Description
show whitelist-db cpsec [mac-address <macaddr>]	Shows detailed information for each AP in the whitelist, including the AP's MAC address, approved state, certificate type and description. Include the optional mac-address <macaddr> parameters to view data for a single entry.
show whitelist-db cpsec-status	The command gives aggregate information for the numbers of APs in each of the following categories: <ul style="list-style-type: none"> • Total entries • Approved entries • Unapproved entries • Certified entries • Certified hold entries • Revoked entries • Marked for deletion entries

Modifying an AP in the Campus AP Whitelist

Use the following procedure to modify a campus AP entry's certificate type, state, description and revoked status via the WebUI.

1. Access the master controller WebUI, and navigate to **Configuration > AP Installation**.
2. Click the **Campus AP Whitelist** tab.
3. Select the checkbox by the entry for the AP you want to edit, then click **Modify**.

If your campus AP whitelist is large and you cannot immediately locate the AP entry you want to edit, select the **Search** link by the upper right corner of the whitelist. The **Campus AP Whitelist** tab displays several fields that allow you to search for an AP with a specified MAC address, certificate type or state. Specify the values that match the AP you are trying to locate, then click the **Search** button. The whitelist displays a list of APs that match your search criteria. Select the AP from this list, then click **Modify**.

4. Update the AP's whitelist entry with the new settings. Some of the configurable parameters were available when you first defined the entry, and are described in [Table 14](#) above. When you modify an existing whitelist entry, you can also configure the following additional parameters that were not configurable when you first created the entry.
 - **Cert-type:** The type of certificate used by the AP.
 - **switch-cert:** The campus AP is using a certificate signed by the controller.
 - **factory-cert:** the campus AP is using a factory-installed certificate. This option should only be used for AP model types W-AP105, the W-AP120 Series and the W-AP130 Series.
 - **State:** When you click the **State** drop-down list to modify this parameter, you may choose one of the following options:
 - **approved-ready-for-cert:** AP has been approved state and is ready to receive a certificate.
 - **certified-factory-cert:** AP is certified and has a factory-installed certificate.
 - **Revoke:** Click the **Revoke** checkbox to revoke an AP's secure status. When you select this checkbox, you can enter a brief comment explaining why the AP is being revoked.
5. Click **Update** to update the campus AP whitelist entry with its new settings.

To modify an entry in the campus AP whitelist via the command-line interface, issue the following commands:

```
whitelist-db cpsec modify mac-address
  cert-type switch-cert|factory-cert
  description <description>
  mode disable|enable
  revoke-text <revoke-text>
  state approved-ready-for-cert|certified-factory-cert
```

Revoking an AP via the Campus AP Whitelist

You can revoke an invalid or rogue AP either by opening the **modify** menu and modifying the AP's revoke status (as described in the section above), or by selecting the AP in the campus whitelist and revoking its secure status directly, without modifying any other parameters or entering a description of why that AP was revoked. When you revoke an AP's secure status in the campus AP whitelist, the whitelist retains the AP's status information. To revoke an invalid or rogue AP and permanently remove the AP from the whitelist, you must delete that entry.

To revoke an AP via the WebUI:

1. Access the master controller WebUI, and navigate to **Configuration>AP Installation**.
2. Click the **Campus AP Whitelist** tab.
3. To revoke one or more secure campus APs, select the checkbox by the entry for each AP whose secure status should be revoked, then click **Revoke**.

If your campus AP whitelist is large and you cannot immediately locate the AP entry you want to revoke, select the **Search** link by the upper right corner of the whitelist. The **Campus AP Whitelist** tab displays several fields that allow you to search for an AP with a specified MAC address, certificate type or state. Specify the values that match the AP you are trying to locate, then click the **Search** button. The whitelist displays a list of APs that match your search criteria. Select the AP from this list, then click **Revoke**.

To revoke an AP via the command-line interface, issue the command:

```
whitelist-db cpsec revoke mac-address <macaddr> revoke-text <"revoke text">
```

Deleting an AP Entry from the Campus AP Whitelist

Before you delete an AP entry from the campus whitelist, verify that auto certificate provisioning is either no longer enabled, or only enabled for IP addresses that do not include the AP being removed. If automatic certificate provisioning is enabled for an AP that it is still connected to the network, you can not permanently delete it from the campus AP whitelist; the controller immediately re-certifies the AP and re-creates its whitelist entry.

To delete an AP entry via the WebUI:

1. Access the master controller WebUI, and navigate to **Configuration>AP Installation**.
2. Click the **Campus AP Whitelist** tab.
3. Select the checkbox by entry for each AP you want to remove, then click **delete**.

If your campus AP whitelist is large and you cannot immediately locate the AP entry you want to delete, select the **Search** link by the upper right corner of the whitelist. The **Campus AP Whitelist** tab displays several fields that allow you to search for an AP with a specified MAC address, certificate type or state. Specify the values that match the AP you are trying to locate, then click the **Search** button. The whitelist displays a list of APs that match your search criteria. Select the AP from this list, then click **delete**.

To delete an AP entry via the CLI, issue the command:

```
whitelist-db cpsec del mac-address <macaddr>
```

Purging the Campus AP Whitelist

Before you add a new local controller to a network using control plane security, you must purge the campus AP whitelist on the new controller. Any entries in a new controller's campus AP whitelist is merged into the whitelist for

all other master and local Dell controllers as soon as the new controller is added to the hierarchy. If any old or invalid AP entries are added to the campus AP whitelist, all Dell controllers in the hierarchy begins trusting those APs, creating a potential security risk. For additional information on adding a new local controller using control plane security to your network, see ["Replacing a Local Controller" on page 93](#)

To purge a controller's campus AP whitelist via the WebUI:

1. Access the master controller WebUI, and navigate to **Configuration > AP Installation**.
2. Click the **Campus AP Whitelist** tab.
3. Click **Purge**.

To purge a campus AP whitelist via the command-line interface, issue the command:

```
whitelist-db cpsec purge
```

Managing Whitelists on Master and Local Controllers

Every controller using the control plane security feature maintains a campus AP whitelist, a local switch whitelist and a master switch whitelist. The contents of these whitelists vary, depending upon the role of the controller, as shown in the figure below.

Table 18: Control Plane Security Whitelists

Controller Role	Campus AP Whitelist	Master Switch Whitelist	Local Switch Whitelist
On a (standalone) master controller with no local Dell controllers:	The campus AP whitelist contains entries for the secure campus APs associated with that controller.	The master switch whitelist is empty, and does not appear in the WebUI.	The local switch whitelist is empty, and does not appear in the WebUI.
On a master controller with local Dell controllers:	The campus AP whitelist contains an entry for every secure campus AP on the network, regardless of the controller to which it is connected.	The master switch whitelist is empty, and does not appear in the WebUI.	The local switch whitelist contains an entry for each associated local controller.
On a Local controller:	The campus AP whitelist contains an entry for every secure campus AP on the network, regardless of the controller to which it is connected.	The master switch whitelist contains the MAC and IP address of the master controller.	The local switch whitelist is empty, and does not appear in the WebUI.

Figure 19: Local Switch Whitelist on a Master Controller

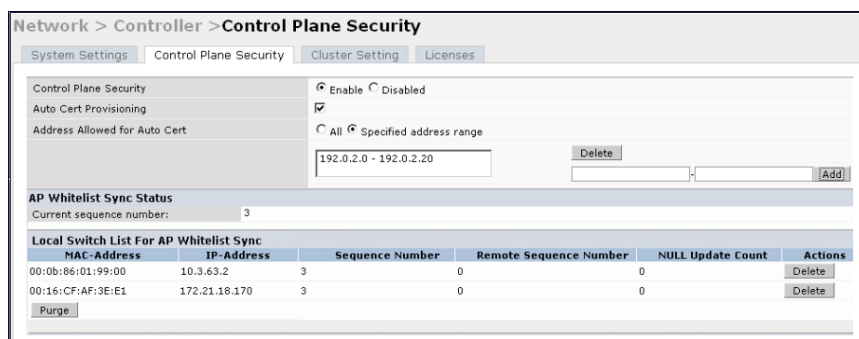

If your deployment includes both master and local Dell controllers, then the campus AP whitelist on every controller contains an entry for every secure AP on the network, regardless of the controller to which it is connected. The master controller also maintains a whitelist of local Dell controllers using control plane security. When you change a campus AP whitelist on any controller, that controller contacts the other connected Dell controllers to notify them of the change.

The master switch whitelist on each local controller contains the IP and MAC addresses of its master controller. If your network has a redundant master controller, then this whitelist contains more than one entry. The master switch whitelist rarely needs to be deleted. Although you can delete an entry from the master switch whitelist, you should do so only if you have removed a master controller from the network.

Campus AP Whitelist Synchronization

The current sequence number in the **AP Whitelist Sync Status** field shows the number of changes to the campus AP whitelist made on that controller. By default, each controller compares its campus AP whitelist against whitelists on other Dell controllers every two minutes. If a controller detects a difference, it sends its changes to the other Dell controllers on the network. If all other Dell controllers on the network have successfully received and acknowledged all whitelist changes made on that controller, every entry in the **sequencenumber** column in the local switch or master switch whitelists has the same value as the sequence number displayed in the **AP Whitelist Sync Status** field. If a controller in the master or local switch whitelist has a lower sequence number, that controller may still be waiting to complete its update, or its update acknowledgement may not have yet been received. In the example in [Figure 19](#), the master controller has a current sequence number of 3, and each sequence number in its local switch whitelist also shows a value of 3, indicating that both local Dell controllers have received and acknowledged all three campus AP whitelist changes made on the master controller. For additional information on troubleshooting whitelist synchronization, see ["Verifying Whitelist Synchronization" on page 98](#).

You can view a controller's current sequence number via the CLI using the command:

```
show whitelist-db cpsec-seq
```

Viewing and Managing the Master or Local Switch Whitelists

The following sections describe the commands to view and delete entries in a master or local switch whitelist.

Viewing the Master or Local Switch Whitelist

To view the master or local switch whitelists via the WebUI, use the procedure below:

1. Access the controller's WebUI, and navigate to **Configuration > AP Installation**.
2. Select the **Whitelist** tab.

The master and local controller switch tables each include the following information:

Table 20: Master and Local Switch Whitelist Information

Data Column	Description
MAC-Address	On a local switch whitelist: MAC address of the master controller. On a master switch whitelist: MAC address of a local controller.
IP-Address	On a local switch whitelist: IP address of the master controller. On a master switch whitelist: IP address of a local controller.
Sequence Number	The number of times the controller in the whitelist received and acknowledged a campus AP whitelist change from the controller whose WebUI you are currently viewing.

Data Column	Description
	For deployments with both master and local Dell controllers: <ul style="list-style-type: none"> The sequence number on a master controller should be the same as the remote sequence number on the local controller. The sequence number on a local controller should be the same as the remote sequence number on the master controller.
Remote Sequence Number	The number of times that the controller whose WebUI you are currently viewing has received and acknowledged a campus AP whitelist change from the controller in the whitelist. For deployments with both master and local Dell controllers: <ul style="list-style-type: none"> The remote sequence number on a master controller should be the same as the sequence number on the local controller. The remote sequence number on a local controller should be the same as the sequence number on the master controller.
Null Update Count	The number of times the controller checked its campus AP whitelist and found nothing to synchronize with the other controller. By default, the controller compares its control plane security whitelist against whitelists on other Dell controllers two minutes. If the null update count reaches 5, the controller sends an "empty sync" heartbeat to the remote controller to ensure the sequence numbers on both Dell controllers are the same, then reset the null update count to zero.

To view the master or local switch whitelists via the command-line interface, issue the following commands:

```
show whitelist-db cpsec-master-switch-list [mac-address <mac-address>]
show whitelist-db cpsec-local-switch-list [mac-address <mac-address>]
```

Deleting an Entry from the Master or Local Switch Whitelist

There is no need to delete a master controller from the master switch whitelist during the course of normal operation. However, if you remove a local controller from the network, you should also remove the local controller from the local switch whitelist on the master controller. If the local switch whitelist contains entries for Dell controllers no longer on the network, then a campus AP whitelist entry can be marked for deletion but is not physically deleted, as the controller is waiting for an acknowledgement from another controller no longer on the network. This can increase network traffic and reduce memory resources on the controller.

To delete an entry from the master or local switch whitelist via the WebUI:

1. Access the controller's WebUI, and navigate to **Configuration>Controller**.
2. Select the **Control Plane Security** tab.
3. To delete an entry from the Local Switch Whitelist: In the **Local Switch List For AP Whitelist Sync** section, click the **Delete** button by each controller entry you want to remove.

Or,

To delete an entry from the Master Controller Whitelist: In the **Master Switch List For AP Whitelist Sync** section, click the **Delete** button by each controller entry you want to remove.

4. Click **Apply** to save your settings.

To delete an entry from the master or local switch whitelist via the command-line interface, issue either of the following commands:

```
whitelist-db cpsec-master-switch-list del mac-address <mac-address>
whitelist-db cpsec-local-switch-list del mac-address <mac-address>
```

Purging the Master or Local Switch Whitelist

There is no need to purge a master switch whitelist during the course of normal operation. If, however, you are removing a controller from the network, you can purge its switch whitelist after it has been disconnected from the network. To clear a local switch whitelist entry on a master controller that is still connected to the network, select that individual whitelist entry and delete it using the **delete** option.

To purge a switch whitelist via the WebUI, use the following procedure:

1. Access the controller's WebUI, and navigate to **Configuration>Controller**.
2. Select the **Control Plane Security** tab.
3. To clear the Local Switch Whitelist: In the **Local Switch List For AP Whitelist Sync** section, click **Purge**.
Or,
4. To clear the Master Switch Whitelist: In the **Master Switch List For AP Whitelist Sync** section, click **Purge**.

To purge a switch whitelist via the command-line interface, issue the following commands:

```
whitelist-db cpsec-master-switch-list purge
whitelist-db cpsec-local-switch-list purge
```

Working in Environments with Multiple Master Controllers

Configuring Networks with a Backup Master Controller

If your network includes a redundant backup master controller, you *must synchronize the database from the primary master to the backup master at least once* after all APs are communicating with their Dell controllers over a secure channel. This ensures that all certificates, IPsec keys and campus AP whitelist entries are synchronized to the backup controller. You should also synchronize the database any time the campus AP whitelist changes (APs are added or removed to ensure that the backup controller has the latest settings).

Master and backup Dell controllers can be synchronized using either of the following methods.

- **Manual Synchronization:** Issue the **database synchronize** CLI command in enable mode to manually synchronize databases from your primary controller to the backup controller.
- **Automatic Synchronization:** Schedule automatic database backups using the **database synchronize period** CLI command in config mode.



WARNING: If you add a new backup controller to an existing controller, the backup controller must be added as the lower priority controller. If the backup controller is not added as a lower priority controller, your control plane security keys and certificates may be lost. If you want the new backup controller to become your primary controller, increase the priority of that controller to a primary controller *after* you have synchronized your data.

Configuring Networks with Clusters of Master Controllers

If your network includes multiple master Dell controllers each with their own hierarchy of APs and local Dell controllers, you can allow APs from one hierarchy to failover to any other hierarchy by defining a *cluster* of master Dell controllers. Each cluster has one master controller as its cluster root, and all other master Dell controllers as cluster members. The master controller operating as the cluster root creates a self-signed certificate, then certifies its own local Dell controllers and APs. Next, the cluster root sends a certificate to each cluster member, which in turn certifies their own local Dell controllers and APs. Since all Dell controllers and APs in the cluster have the same trust anchor, the APs can switch to any other controller in the cluster and still remain securely connected to the network.

Figure 21: A Cluster of Master Controllers using Control Plane Security

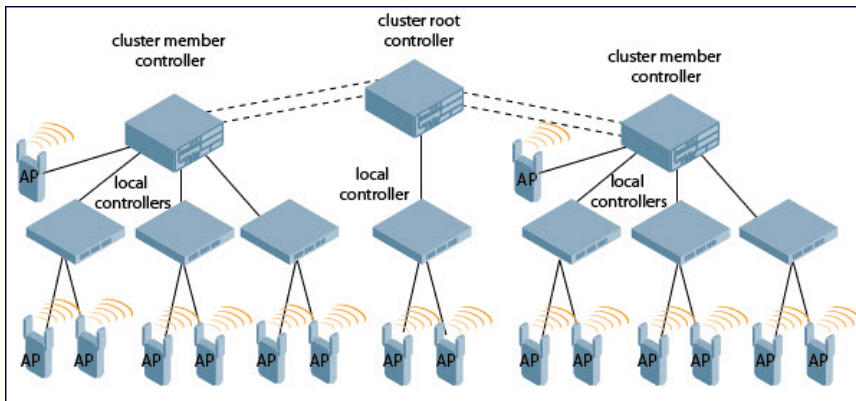

To create a controller cluster, you must first define the root master controller and set an IPsec key or select a certificate for communications between the cluster root and cluster members.

NOTE: You must use the command-line interface to configure certificate authentication for cluster members. The WebUI supports cluster authentication using IPsec keys only. If your master and local Dell controllers use a pre-shared key for authentication, they create the IPsec tunnel using IKEv1. If your master and local Dell controllers use certificates for authentication, the IPsec tunnel is created using IKEv2.

Creating a Cluster Root

Use the WebUI to identify a controller as a cluster root and use an IPsec key to secure communication between the cluster root and cluster members. Use the command-line interface to create a cluster root using an IPsec key, factory-installed certificate or custom certificate.

To create a cluster root using the WebUI:

1. Access the WebUI of the controller you want to become the cluster root, and navigate to **Configuration > Controller**.
2. Click the **Cluster Setting** tab.
3. For the cluster role, select **Root**.
4. In the **Cluster Member IPsec Keys** section, enter the switch IP address of a member controller in the cluster. If you want to use a single key for all member Dell controllers, use the IP address **0.0.0.0**.
5. In the **IPsec Key** and **Retype IPsec Key** fields, enter the IPsec key for communication between the specified member controller and the cluster root.
6. Click **Add**.
7. *Optional:* repeat steps 4-6 to add another member controller to the cluster.
8. Click **Apply** to save your settings

To create a cluster root via the CLI, access the command-line interface of the controller you want to become the root of the controller cluster, then issue one of the following commands.

- To authenticate cluster members using a custom certificate:

```
cluster-member-custom-cert member-mac <mac> ca-cert <ca> server-cert <cert> suite-b <gcm-128 | gcm-256>]
```
- To authenticate cluster members using a factory-installed certificate.

```
cluster-member-factory-cert member-mac <mac>
```
- To authenticate cluster members using an IPsec key:

```
cluster-member-ip <ip-address> ipsec <key>
```

The `<ip-address>` parameter in this command is the IP address of a member controller in the cluster, and the `<key>` parameter in each command is the IPsec key for communication between the specified member controller and the cluster root. Use the IP address `0.0.0.0` in this command to set a single IPsec key for all member Dell controllers, or repeat this command as desired to define a different IPsec key for each cluster member.

Creating a Cluster Member

Once you have identified the cluster root, you must then identify the member Dell controllers in the cluster.

Use the WebUI to identify a controller as a cluster member and use an IPsec key to secure communication between the cluster member and the cluster root. Use the command-line interface to create a cluster member and secure communications between that member and the cluster root using an IPsec key, factory-installed certificate or custom certificate.

To create a cluster member using the WebUI:

1. Access the WebUI of the cluster member controller, and navigate to **Configuration > Controller**.
2. Click the **Cluster Setting** tab.
3. For the cluster role, select **Member**.
4. In the **Controller IP Address** field, enter the IP address of the root controller in the cluster.
5. In the **IPsec Key** and **Retype IPsec Key** fields, enter the IPsec key for communication between the specified member controller and the cluster root. This parameter must be have the same value as the key defined for the cluster member in ["Creating a Cluster Root" on page 91](#).
6. Click **Add**.
7. Click **Apply** to save your settings.

To create a cluster root via the CLI, access each of the member master Dell controllers and define the IPsec key or certificate for communication between that controller and the cluster root.

```
cluster-root-ip <ip-address>
  ipsec <key>
  factory-cert master-mac <mac>
  ipsec-custom-cert master-mac1 <mac1> [master-mac2 <mac2>] ca-cert <ca> server-cert <cert>
  [suite-b <gcm-128 | gcm-256>]
```

In this command the `<ip-address>` parameter is the IP address of the root master controller in the cluster. If you are using an IPsec key, the `<key>` parameter in this command must be have the same value as the key defined for the cluster member via the `cluster-member-ip` command.

Viewing Controller Cluster Settings

To view your current cluster configuration via the WebUI:

1. Navigate to **Configuration > Controller**.
2. Click the **Cluster Setting** tab.
 - If you are viewing the WebUI of a cluster root, the output of this command displays the IP address of the VLAN on the cluster member used to connect to the cluster root.
 - If you are viewing the WebUI of a cluster member, the output of this command displays the IP address of the VLAN on the cluster root used to connect to the cluster member.

To view your current cluster configuration via the command-line interface, issue the CLI commands described in [Table 22](#).

Table 22: CLI Commands to Display Cluster Settings

Command	Description
show cluster-switches	When you issue this command from the cluster <i>root</i> , the output of this command displays the IP address of the VLAN used by the cluster member to connect to the cluster root. If you issue this command from a cluster <i>member</i> , the output of this command displays the IP address of the VLAN used by the cluster root to connect to the cluster member.
show cluster-config	When you issue this command from the cluster <i>root</i> , the output of this command shows the cluster role of the controller, and the IP address of each active member controller in the cluster. When you issue this command from a cluster <i>member</i> , the output of this command shows the cluster role of the controller, and the IP address of the cluster root.

Replacing a Controller on a Multi-Controller Network

The procedure to replace a controller within a multi-controller network varies, depending upon the role of that controller, whether the network has a single master controller or a cluster of master Dell controllers, and whether or not the controller has a backup.

 NOTE: The following sections describe the steps to replace an existing controller. To add a new local controller to a network, or permanently remove a local controller without replacing it, see "[Viewing and Managing the Master or Local Switch Whitelists](#)" on page 88.

Replacing Controllers in a Single Master Network

Use the procedures in this section to replace a master or local controller in a network environment with a single master controller.

Replacing a Local Controller

Use the following procedure to replace a local controller in a single-master network.

1. Disconnect the local controller from the network.
2. If you plan on moving the local controller to another location on the network, purge the campus AP whitelist on the controller.
Access the command-line interface on the old local controller and issue the command `whitelist-db cpsec purge`
or,
Access the local controller WebUI, navigate to **Configuration>AP Installation>Campus AP Whitelist** and click **Purge**.
3. Once the campus AP whitelist has been purged, you must inform the master controller that the local controller is no longer available. .

 NOTE: **This step is very important**; unused local controller entries in the local switch whitelist can significantly increase network traffic and reduce controller memory resources.

Access the command-line interface on the master controller, and issue the command `whitelist-db cpsec-local-switch-list del mac-address <local-controller-mac>`
-or -
Access the master controller WebUI, navigate to the **Configuration>Controller>Control Plane Security**

window, select the entry for the local controller you want to delete from the local switch whitelist, and click **Delete**.

4. Install the new local controller, but do not connect it to the network yet. If the controller has been previously installed on the network, you must ensure that the new local controller has a clean whitelist.
5. Access the command-line interface on the new local controller and issue the command
`whitelist-db cpsec purge`
Or,
Access the local controller WebUI, navigate to **Configuration > AP Installation > Campus AP Whitelist** and click **Purge**.
6. Now, connect the new local controller to the network. It is very important that the local controller is able to contact the master controller the first time it is connected to the network, because the local controller tries to get its control plane security certificate certified by the master controller the first time the local controller contacts its master.
7. Once the local controller has a valid control plane security certificate and configuration, the local controller receives the campus AP whitelist from the master controller and starts certifying approved APs.
8. APs associated with the new local controller reboots and creates new IPsec tunnels to their controller using the new certificate keys

Replacing a Master Controller with No Backup

Use the following procedure to replace a master controller that does not have a backup controller.

1. Remove the old master controller from the network.
2. Install and configure the new master controller, then connect the new master to the network. The new master controller generates a new certificate when it first becomes active
3. If the new master controller has a different IP address than the old master controller, change the master IP address on the local Dell controllers to reflect the address of the new master.
4. Reboot each local controller to ensure that the local Dell controllers get their certificate from the new master. Each local controller begins using a new certificate signed by the master controller.
5. APs are now no longer be able to securely communicate with the controller using their current key, and must receive a new certificate. Access the campus AP whitelist on any local controller and change all APs in a “certified” state to an “approved” state. The new master controller sends the approved APs new certificates. The APs reboot and create new IPsec tunnels to their controller using the new certificate key.

If the master controller does not have any local Dell controllers, you must recreate the campus AP whitelist by turning on automatic certificate provisioning or manually reentering the campus AP whitelist entries.

Replacing a Redundant Master Controller

The control plane security feature requires you to synchronize databases from the primary master controller to the backup master controller at least once after the network is up at running. This ensures that all certificates, keys and whitelist entries are synchronized to the backup controller. Since the AP whitelist may change periodically, the network administrator should regularly synchronize these settings to the backup controller. For details, see ["Configuring Networks with a Backup Master Controller" on page 90](#)

When you install a new backup master controller, *you must add it as a lower priority* controller than the existing primary controller. After you install the backup controller on the network, synchronize the database from the existing primary controller to the new backup controller to ensure that all certificates, keys and whitelist entries required for control plane security are added to the new backup controller configuration. If you want the new controller to act as the primary controller, you can increase that controller's priority *after* the settings have been synchronized.

Replacing Controllers in a Multi-Master Network

Use the following procedures to replace a master or local controller in a network environment with a multiple master Dell controllers.

Replacing a Local Controller in a Multi-Master Network

The procedure to replace a local controller in a network with multiple master Dell controllers is the same as the procedure to replace a local controller in a single-master network. To replace a local controller in a multi-master network, follow the procedure described in ["Replacing a Local Controller" on page 93](#)

Replacing a Cluster Member Controller with no Backup

The control plane security feature allows APs to fail over from one controller to another within a cluster. Therefore, cluster members or their local Dell controllers may have associated APs that were first certified under some other cluster member (or the cluster root). If you permanently remove a cluster member whose APs were all originally certified under the cluster member being removed, its associated APs do not need to reboot in order to connect to a different controller. If, however, you remove a cluster member whose associated APs were originally certified under a *different* cluster member, those APs need to reboot and get recertified before they can connect to a different controller. If the cluster member you are removing has local Dell controllers, the local Dell controllers also reboot so they can update themselves with new certificates, then pass the trust update to their terminating APs.

To replace a cluster member that does not have a backup controller:

1. On the cluster master to be removed, clear the cluster root IP address by accessing the command-line interface and issuing the command
`no cluster-root-ip <cluster-root-ip> ipsec <clusterkey>`
2. Remove the cluster member from the network.
3. If the cluster master you removed has any associated APs, you must reboot those APs so they get an updated certificate.
4. If the cluster member you removed has any associated local Dell controllers, reboot those local Dell controllers so they can get a new certificate and then pass that trust update to their APs.
5. Remove the cluster master from the cluster root's master controller list by accessing the command-line interface on the cluster root and issuing the command `whitelist-db cpsec-master-switch-list del mac-address <cluster-master-mac>`.



NOTE: This step is very important; unused local controller entries in the local switch whitelist can significantly increase network traffic and reduce controller memory resources.

6. Remove the old cluster member from the network. Remember, that controller still has campus AP whitelist entries from the entire cluster. You may want to delete or revoke unwanted entries from the campus AP whitelist.

Now, you must install the new cluster member controller according to the procedure described in ["Creating a Cluster Member" on page 92](#). The new cluster member obtains a certificate from the cluster root when it first becomes active.

7. If the new cluster member has any associated APs, reboot those APs to allow them to get a trust update.
8. If the new cluster member has any local Dell controllers, reboot the local controllers associated with the new cluster member. The local Dell controllers obtain a new certificate signed by the cluster member, and then pass that trust update to their associated APs.

Replacing a Redundant Cluster Member Controller

The control plane security feature requires you to synchronize databases from the primary controller to the backup controller at least once after the network is up at running. This ensures that all certificates, keys and whitelist entries

are synchronized to the backup controller. Since the AP whitelist may change periodically, the network administrator should regularly synchronize these settings to the backup controller. For details, see ["Configuring Networks with a Backup Master Controller" on page 90](#).

When you install a new backup cluster member, *you must add it as a lower priority* controller than the existing primary controller. After you install the backup cluster member on the network, resynchronize the database from the existing primary controller to the new backup controller to ensure that all certificates, keys and whitelist entries required for control plane security are added to the new backup controller configuration. If you want the new controller to act as the primary controller, you can increase that controller's priority *after* the settings have been resynchronized.

Replacing a Cluster Root Controller with no Backup Controller

If you replace a cluster root controller that does not have a backup controller, the new cluster root controller creates its own self-signed certificate. You then need to reboot each controller in the hierarchy in a specific order to certify all APs with that new certificate.

1. Remove the old cluster root from the network.
2. Install and configure the new cluster root.
3. Connect the new cluster root to the network so it can access cluster masters and local Dell controllers.
4. If necessary, reconfigure the cluster masters and local Dell controllers with their new cluster root IP and master IP addresses.
5. Reboot every cluster member controller. The cluster member begins using a new certificate signed by the cluster root.
6. Reboot every local controller. Each local controller begins using a new certificate signed by the cluster member.
7. Because the cluster root is new, it does not have a configured campus AP whitelist. Access the campus AP whitelist on any local controller or cluster master and change all APs in a "certified" state to an "approved" state. The APs get recertified, reboot and create new IPsec tunnels to their controller using the new certificate key.

If a cluster root controller does not have any cluster master or local Dell controllers, you must recreate the campus AP whitelist on the cluster root by turning on automatic certificate provisioning or manually reentering the campus AP whitelist entries.

Replacing a Redundant Cluster Root Controller

Dell recommends using a backup controller with your cluster root controller. If your cluster root has a backup controller, you can replace the backup cluster root without having to reboot all cluster master and local Dell controllers, minimizing network disruptions.

The control plane security feature requires you to synchronize databases from the primary controller to the backup controller at least once after the network is up at running. This ensures that all certificates, keys and whitelist entries are synchronized to the backup controller. Since the AP whitelist may change periodically, the network administrator should regularly synchronize these settings to the backup controller. For details, see ["Configuring Networks with a Backup Master Controller" on page 90](#).

When you install a new backup cluster root, *you must add it as a lower priority* controller than the existing primary controller. After you install the backup cluster root on the network, resynchronize the database from the existing primary controller to the new backup controller to ensure that all certificates, keys and whitelist entries required for control plane security are added to the new backup controller configuration. If you want the new controller to act as the primary controller, you can increase that controller's priority *after* the settings have been resynchronized.

Configuring Control Plane Security after Upgrading

When you initially deploy a controller running ArubaOS 6.0 or later, create your initial control plane security configuration using the initial setup wizard. However, if you are upgrading to ArubaOS 6.0 or if you are upgrading from ArubaOS 5.0 *but did not yet have control plane security enabled before the upgrade*, then you can use the strategies described in [Table 23](#) to enable and configure control plane security feature.



NOTE: If you upgrade a controller running ArubaOS 5.0.x to ArubaOS 6.0 or later, then the controller's control plane security settings do not change after the upgrade. If control plane security was already enabled, then it remains enabled after the upgrade. If it was not enabled previously, but you wish to use the feature after upgrading, then it must be manually enabled.

Table 23: Control Plane Security Upgrade Strategies

Automatically send Certificates to Campus APs	Manually Certify Campus APs
1. Access the control plane security window and enable both the control plane security feature and the auto certificate provisioning option. Next, specify whether you want all associated campus APs to automatically receive a certificate, or if you want to certify only those APs within a defined range of IP addresses.	1. Identify the campus APs that should receive certificates by entering the campus APs' MAC addresses in the campus AP whitelist.
2. Once all APs have received their certificates, disable auto certificate provisioning to prevent certificates from being issued to any rogue APs that may appear on your network at a later time.	2. If your network includes both master and local Dell controllers, wait a few minutes, then verify that the campus AP whitelist has been propagated to all other Dell controllers on the network. Access the WebUI of the master controller, navigate to Configuration>Controller>Control Plane Security , then verify that the Current Sequence Number field has the same value as the Sequence Number entry for each local controller in the local switch whitelist. (For details, see " Verifying Whitelist Synchronization " on page 98.)
3. If a valid AP did not receive a certificate during the initial certificate distribution, you can manually certify the AP by adding that AP's MAC address to the campus AP whitelist. You can also use this whitelist to revoke certificates from APs that should not be allowed access to the secure network.	3. Enable the control plane security feature.



NOTE: If you upgraded your controller from ArubaOS 5.0 or earlier and you want to use this feature for the first time, you must either add all valid APs to the campus AP whitelist or enable automatic certificate provisioning *before you enable the feature*. If you do not enable automatic certificate provisioning, only the APs currently approved in the campus AP whitelist are allowed to communicate with the controller over a secure channel. Any APs that do not receive a certificate are not be able to communicate with the controller except to request a certificate.

Troubleshooting Control Plane Security

Identifying Certificate Problems

If an AP has a problem with its certificate, check the state of the AP in the campus AP whitelist. If the AP is in either the certified-hold-factory-cert or certified-hold-switch-cert states, you may need to manually change the status of that AP before it can be certified.

- **certified-hold-factory-cert:** An AP is put in this state when the controller thinks the AP has been certified with a factory certificate yet the AP requests to be certified again. Since this is not a normal condition, the AP is not

approved as a secure AP until a network administrator manually changes the status of the AP to verify that it is not compromised. If an AP is in this state due to connectivity problems, then the AP recovers and is taken out of this hold state as soon as connectivity is restored.

- **certified-hold-switch-cert:** An AP is put in this state when the controller thinks the AP has been certified with a controller certificate yet the AP requests to be certified again. Since this is not a normal condition, the AP is not be approved as a secure AP until a network administrator manually changes the status of the AP to verify that it is not compromised. If an AP is in this state due to connectivity problems, then the AP recovers and is taken out of this hold state as soon as connectivity is restored.

Verifying Certificates

If you are unable to configure the control plane security feature on W-600 Series, W-3000 Series, W-6000M3, or W-7200 Series Dell controllers, verify that its Trusted Platform Module (TPM) and factory-installed certificates are present and valid by accessing the controller's command-line interface and issuing the command `show tpm cert-info`. If the controller has a valid certificate, the output of the command should appear similar to the output in the example below.

```
(host) # show tpm cert-info
subject= /CN=AC1234567::00:0b:86:11:22:33
issuer= /DC=com/DC=companyname/DC=ca3/CN=DEVICE-CA3
serial=5147D5BC000000000000C
notBefore=Aug 29 22:16:12 2009 GMT
notAfter=Aug 18 22:16:12 2029 GMT
```

If the controller displays the following output, it may have a corrupted or missing TPM and factory certificates. Contact Dell technical support.

```
(host) # show tpm cert-info
Cannot get TPM and Factory Certificate Info.
```

Disabling Control Plane Security

If you disable control plane security on a standalone or local controller, all APs connected to that controller reboot then reconnect to the controller over a clear channel.

If you disable control plane security on a *master* controller, APs directly connected to the master controller reboot then reconnect to the master controller over a clear channel. However, its local Dell controllers continue to communicate with their APs over a secure channel until you save your configuration on the master controller. Once you save the configuration, the changes are pushed down to the local Dell controllers. At that point, any APs connected to the local Dell controllers also reboot and reconnect over a secure channel.

Verifying Whitelist Synchronization

To verify that a network of master and local Dell controllers are correctly sharing their campus AP whitelists, check the sequence numbers on the master and local switch whitelists.

- The sequence number value on a master controller should be the same as the remote sequence number on the local controller.
- The sequence number value on a local controller should be the same as the remote sequence number on the master controller.

Figure 24: Sequence numbers on Master and Local Controllers

The screenshot shows the configuration for a Master controller and a Local controller. Both have 'Control Plane Security' enabled and 'Auto Cert Provisioning' checked. The 'Address Allowed for Auto Cert' is set to 'Specified address range'.

Master Controller:

- AP Whitelist Sync Status: Current sequence number: 92
- Local Switch List For AP Whitelist Sync:

MAC-Address	IP-Address	Sequence Number	Remote Sequence Number	NULL Update Count	Actions
00:0b:86:61:10:79	10.4.21.33	92	175	1	Delete
00:0b:86:61:10:16	10.4.21.200	92	148	1	Delete

Local Controller:

- AP Whitelist Sync Status: Current sequence number: 148
- Master Switch List For AP Whitelist Sync:

MAC-Address	IP-Address	Sequence Number	Remote Sequence Number	NULL Update Count	Actions
00:0b:86:61:10:4c	10.4.21.34	148	92	4	Delete

A red circle highlights the 'Sequence Number' 92 in the Master's list and the 'Remote Sequence Number' 92 in the Local's list. A red arrow points from the Master's entry to the Local's entry.

Supported APs

The control plane security feature is supported on AP models W-AP105 and W-AP120 Series, W-AP130 Series, and W-AP175 Series. APs that do not support control plane security are not able to connect to a controller enabled with this feature.

Rogue APs

If you enable auto certificate provisioning enabled with the **Auto Cert Allow All** option, any AP that appears on the network receive a certificate. If you notice unwanted or rogue APs connecting to your controller via an IPsec tunnel, verify that automatic certificate provisioning has been disabled, then manually remove the unwanted APs by deleting their entries from the campus AP whitelist.

Chapter 6

Software Licenses

ArubaOS base features include sophisticated authentication and encryption, protection against rogue wireless APs, seamless mobility with fast roaming, the origination and termination of IPsec/L2TP/PPTP tunnels between Dell controllers, clients, and other VPN gateways, adaptive RF management and analysis tools, centralized configuration, and location tracking.

Optional add-on licenses provide advanced feature such as Wireless Intrusion Protection and Policy Enforcement Firewall. Evaluation licenses are available for some of these advanced features.

ArubaOS licenses are detailed in the following sections:

- ["Understanding License Terminology "](#) on page 100
- ["Working with Licenses"](#) on page 101
- ["Working with Licenses on a Multiple Controller Network"](#) on page 102
- ["Using Licenses"](#) on page 102
- ["License Installation Best Practices and Exceptions"](#) on page 104
- ["Installing a License"](#) on page 104
- ["Deleting a License "](#) on page 106
- ["Moving Licenses"](#) on page 106
- ["Resetting the Controller"](#) on page 106

Understanding License Terminology

For clarity, the following terminology is used throughout this chapter.

- **Bundle**—a cost effective way to purchase functionality that supports a controller and x-number of APs.
- **Certificate ID**—the identification number attached to the Software License Certificate. The Certificate ID is used in conjunction with the controller's serial number to create the License Key.
- **Evaluation License**—a license that allows you to evaluate a feature set (or module) for a maximum of 90 days. The evaluation licenses are uploaded in 30 day increments. Only modules that offer new and unique functionality support Evaluation Licenses.
- **License Certificate**—a certificate (soft copy) that contains license information including:
 - License Description
 - Quantity
 - Part Number/Order Number
 - Certificate ID
- **License Database**—the licenses installed on your controller
- **License Key**—generated from the controller serial number
- **Permanent License**—the opposite of an evaluation license. This license permanently installs the specific features represented by the license.

- Upgrade License—a license that adds AP capacity to your controller. Note that Upgrade Licenses do not support an evaluation license.

Working with Licenses

Each license refers to specific functionality (or module) that supports unique features.

The licenses are:

- Base OS—base operating functions including VPN and VIA clients.
- AP Capacity —capacity license for RAP indoor and outdoor Mesh APs. Campus, Remote, or Mesh APs can terminate on the controller without the need for a separate license.
- Advanced Cryptography (ACR)—this is required for the Suite B Cryptography in IPsec and 802.11 modes. License enforcement behavior controls the total number of concurrent connections (IPsec or 802.11) using Suite B Cryptography. Bundled with this license are the xSec license features.
- Policy Enforcement Firewall Virtual Private Network (PEFV)—enables Policy Enforcement Firewall for VIA clients. This is a controller license.
- Policy Enforcement Firewall Next Generation (PEFNG)—Wired, WLAN Licensed per AP numbers including user roles, access rights, Layers 4 through 7 traffic control, per-service prioritization/QoS, authentication/accounting APIs, External Service Interfaces (ESI), Voice and Video. This is an AP count license.
- Public Access—reserved for future use.
- RFprotect—Wireless Intrusion Protection (WIPS) and Spectrum Analysis. This is an AP count license.
- xSec (Extreme Security) for Federal—Layer 2 VPN for wired or wireless using FIPS-approved algorithms.
- Internal Test Functions—for internal use only.

The license categories are:

- **Permanent license**—This type of license permanently enables the desired software module on a specific Dell controller. You obtain permanent licenses through the sales order process only. Permanent software license keys are sent to you via email.
- **Evaluation license**—This type of license allows you to evaluate the unrestricted functionality of a software module on a specific controller for 90 days (in three 30-day increments).

An expired evaluation license will remain in the license database until the controller is reset using the command `write erase all` where all license keys are removed. An expired evaluation license has no impact on the normal operation of the controller. It is kept in the license database to prevent abuse.



NOTE: When license keys are applied on a controller, abnormal tampering of the device's system clock (setting the system clock back) results in the disabling of software licensed modules and their supported features. This can affect network services.

To determine your time remaining on an evaluation license, a banner is displayed when you log in through the command line:

```
NOTICE
NOTICE -- This switch has active licenses that will expire in 29 days
NOTICE
NOTICE -- See 'show license' for details.
NOTICE
```

From the WebUI, an “Alert” appears with information regarding the evaluation license status (see [Figure 25](#)).

Figure 25: Alert Flag

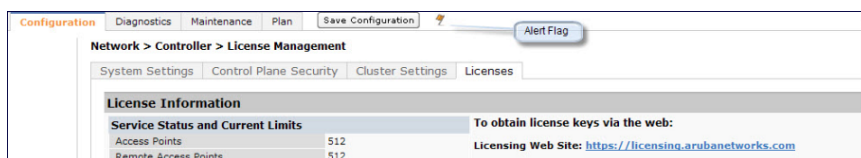

At the end of the 90-day period, you must apply for a permanent license to re-enable the features permanently on the controller. Evaluation software license keys are only available in electronic form and are emailed to you.

When an evaluation period expires:

- The controller automatically backs up the startup configuration and reboots itself at midnight (according to the system clock).
- All permanent licenses are unaffected. The expired evaluation licensed feature is no longer available and is displayed as **Expired** in the WebUI.
- **Upgrade license**—This license expands AP capacity. There are no Evaluation licenses available for Upgrade licenses.

Working with Licenses on a Multiple Controller Network

In order to configure each feature on the local controller, the master controller(s) must be licensed for each feature configured on the local Dell controllers. If present, a backup master must be licensed with the same features as the Master. Backup Dell controllers are “hot-standby”, that is, the backup controller processes AP, traffic, etc. while standing by in backup mode.

Best practices is to install the same set of feature licenses on every controller in your network.

Using Licenses

Licenses are platform independent and can be installed on any Dell controller. Installation of the feature license unlocks that feature’s functionality for the maximum capacity of the controller.



NOTE: The license limits are enforced until you reach the controller limit (see [Table 27](#))

[Table 26](#) lists how licenses are consumed on the Controllers.

Table 26: Usage per License

License	Basis	What Consumes One License
PEFNG	AP	One operational AP
xSec	Session	One active client termination
RFprotect	AP	One operational AP
AP	AP	One operational LAN-connected or mesh AP that is advertising at least one BSSID (virtual-AP) or RAP
ACR	Session	One active client termination

The controller licenses are variable-capacity (see [Table 27](#)).



NOTE: In Table 27, the Remote AP count is equal to the total AP count for all the Dell controllers. The Campus AP count is 1/4 of the total AP count *except* for the W-6000M3 which is 1/2 the AP count.

Table 27: Controller AP Capacity

Controller	Total AP Count	Campus APs	Remote APs
W-7210	512	512	512
W-7220	1024	1024	1024
W-7240	2048	2048	2048
W-6000M3	1024	512	1024
W-3200	128	32	128
W-3400	256	64	256
W-3600	512	128	512
W-620	8	8	8
W-650	16	16	16

Understanding License Interaction

The various licenses do require some equality and other important interactions.

- AP/PEFNG and RFprotect must be equal
 - All active APs run AP/PEFNG and RFprotect services (if enabled). If they are not equal, the number of active APs are restricted to the minimum of the AP/PEFNG and RFprotect license count.



NOTE: It is not possible to designate specific APs for RFprotect/non-RFprotect operations.

- Mesh portals/mesh points, with no virtual-APs, do not consume a RFprotect license
- If a Mesh node is also configured for client service (advertises a BSSID for example), it consumes one AP license
- RAPs consume licenses the same as a campus AP.
- ACR Interaction
 - On a platform that supports 2048 IPsec tunnels, the maximum number of Suite B IPsec tunnels supported is 2048, even if a larger capacity license is installed.
 - The ACR license is cumulative. If you want to support 2048 Suite B connections, install two ACR licenses (LIC-ACR-1024).
 - An evaluation ACR license is available (EVL-ACR-1024). You can install the ACR evaluation license with a higher capacity than the platform maximum.
 - On a platform that supports 2048 IPsec tunnels, with a LIC-ACR-512 installed, only 512 IPsec tunnels can be terminated using Suite B encryption. An additional 1536 IPsec tunnels, using non-Suite B modes (e.g. AES-CBC), can still be supported.
 - On a platform with LIC-ACR-512 installed, a mixture of IPsec and 802.11i Suite B connections can be supported. The combined number of these sessions may not exceed 512.

- A single client using both 802.11i Suite B and IPsec Suite B simultaneously will consume two ACR licenses.

License Installation Best Practices and Exceptions

- Back up the controller's configuration (**backup flash** command) and back up the License database (**license export filename**) before making any changes.

```
(host) #backup flash
Please wait while we tar relevant files from flash...
Please wait while we compress the tar file...
Checking for free space on flash...
Copying file to flash...
File flashbackup.tar.gz created successfully on flash.
Please copy it out of the switch and delete it when done.
(host) #license export licensebackup.db
Successfully exported 1 licenses from the License Database to licensebackup.db
```

- Allow for the maximum quantity required at any given time
- When calculating AP licenses, determine the normal AP load of your controller and add backup load for failure scenarios
- Use 20 users per AP as a reasonable estimate when calculating user licenses. Do not forget to consider occasional large assemblies or gatherings.

Installing a License

The Dell licensing system is controller-based. A license key is a unique alphanumeric string generated using the controller's serial number and is valid only for that controller only. Licenses can be pre-installed at the factory so that all licensed features are available upon initial setup. Or you can install licenses features yourself.



NOTE: Dell recommends that you obtain a user account on the Dell Software License Management website even if software license keys are pre-installed on your controller.

Enabling a new license on your controller

The basic steps to installing and enabling a new license feature are listed below along with a reference to a section in this document with more detailed information.

1. Obtain a valid Dell software license from your sales account manager or authorized reseller (see "[Requesting a Software License in Email](#)" on page 105).
2. Locate the system serial number of your controller (see "[Locating the System Serial Number](#)" on page 105).
3. Use your system's serial number to obtain a software license key from the Dell Software License Management website licensing.dell-pcw.com/ (see "[Obtaining a Software License Key](#)" on page 105).
4. Enter the software license key via the controller's WebUI; navigate to **Configuration > Network > Controller > System Settings** page and select the **License** tab. Enter the software license key and click **Apply** (see "[Applying the Software License Key in the WebUI](#)" on page 106).

Or

Launch the License Wizard from the **Configuration** tab and click the **New** button. Enter the software license key in the space provided (see "[Applying the Software License Key in the License Wizard](#)" on page 106).

5. Reboot your controller to enable your new license and features.

Requesting a Software License in Email

To obtain either a permanent or evaluation software license, contact your sales account manager or authorized reseller. The license details are provided via email with an attached text file. Use the text file to cut and paste the licensing information into the WebUI or at the command line.



NOTE: Ensure that you have provided your sales person with a valid email address.

The email also includes:

- The orderable part number for the license
- A description of the software module type and Dell controller for which it is valid
- A unique, 32-character alphanumeric string used to access the license management website and which, in conjunction with the serial number of your controller, generates a unique software license key

Locating the System Serial Number

Each controller has a unique serial number located at the rear of the controller chassis. The W-6000M3 has the serial number on the device itself.

You can also find the serial numbers by navigating to the **Controller > Inventory** page on the WebUI or by executing the **show inventory** command from the CLI.



NOTE: To physically inspect the system serial number on a W-6000M3, you need to remove the device from the controller chassis, which may result in network down time.

Obtaining a Software License Key

To obtain a software license key, you must log in to the Dell License Management website at:

licensing.dell-pcw.com/

If you are a first time user of the licensing site, you can use the software license certificate ID number to log in initially and request a user account. If you already have a user account, log in to the site.

Once logged in, you are presented with several options:

- **Activate a certificate:** Activate a new certificate and create the software license key that you will apply to your controller.
- **Transfer a certificate:** Transfer a software license certificate ID from one controller to another (for example, transferring licenses to a spare system).
- **Import preloaded certificates:** For controllers on which licenses are pre-installed at the factory, transfer all software license certificate IDs used on the sales order to this user account.
- **List your certificates:** View all currently available and active software license certificates for your account.

Creating a Software License Key

To create a software license key, you must log in to the Dell License Management website at:

licensing.dell-pcw.com/

If you are a first time user of the licensing site, you can use the software license certificate ID number to log in initially and request a user account. If you already have a user account, log in to the site.

1. Select **Activate a Certificate**.
2. Enter the certificate ID number and the system serial number of your controller.

3. Review the license agreement and select **Yes** to accept the agreement.
4. Click **Activate it**. A copy of the transaction and the software license key is emailed to you at the email address you entered for your user account



NOTE: The software license key is *only* valid for the system serial number for which you activated the certificate.

Applying the Software License Key in the WebUI

To enable the software module and functionality, you must apply the software license key to your controller:

1. Log in to your controller's WebUI.
2. Navigate to the **Configuration > Network > Controller > System Settings** page and select the **License** tab.
3. Copy the software license key, from your email, and paste it into the **Add New License Key** field. Click **Add**.
4. Reboot your controller to enable the new license feature.

Applying the Software License Key in the License Wizard

Log in to your controller's WebUI.

1. Launch the License Wizard from the **Configuration** tab and click the **New** button.
2. The License Wizard will step you through the activation process. Click on the **Help** tab within the License Wizard for additional assistance.
3. Reboot your controller to enable the new license feature.

Deleting a License

To remove a license from a system:

1. Navigate to the **Configuration > Network > Controller > System Settings** page and select the **License** tab.
2. Scroll down to the **License Table** and locate the license you want to delete.
3. Click the **Delete** button at the far right hand side of the license to delete the license.

If a license feature is under an evaluation license, no key is generated when the feature is deleted.

Moving Licenses

It may become necessary to move licenses from one controller to another or simply delete the license for future use. To move licenses, delete the license from the chassis as described in ["Deleting a License " on page 106](#). Then install the license key on the new controller as described in ["Applying the Software License Key in the WebUI" on page 106](#).



NOTE: The ability to move a license from one controller to another is provided for maximum flexibility in managing an organization's network and to minimize an RMA impact. Dell monitors and detects license fraud. Abnormally high volumes of license transfers for the same license certificate to multiple Dell controllers can indicate breach of the Dell end user software license agreement and will be investigated.

Resetting the Controller

Rebooting or resetting a controller has no effect on either permanent or evaluation licenses.

Issuing the **write erase** command on a controller running software licenses does *not* affect the license key management database on the controller.

Issuing the **write erase all** command resets the controller to factory defaults, and deletes all databases on the controller including the license key management database. You must reinstall all previously-installed license keys.

A W-7200 Series controller can be reset using the LCD screen. Issuing the **Factory Default** option under the **Maintenance** menu returns the controller to the factory default settings. For more information about the LCD menu, see [Using the LCD Screen](#).

Chapter 7

Network Configuration Parameters

The following topics in this chapter describe some basic network configuration on the controller:

- ["Configuring VLANs" on page 108](#)
- ["Configuring Ports " on page 114](#)
- ["Understanding VLAN Assignments" on page 117](#)
- ["Configuring Static Routes" on page 123](#)
- ["Configuring the Loopback IP Address" on page 124](#)
- ["Configuring the Controller IP Address" on page 125](#)
- ["Configuring GRE Tunnels" on page 125](#)

Configuring VLANs

The controller operates as a layer-2 switch that uses a VLAN as a broadcast domain. As a layer-2 switch, the controller requires an external router to route traffic between VLANs. The controller can also operate as a layer-3 switch that can route traffic between VLANs defined on the controller.

You can configure one or more physical ports on the controller to be members of a VLAN. Additionally, each wireless client association constitutes a connection to a *virtual port on the controller*, with membership in a specified VLAN. You can place all authenticated wireless users into a single VLAN or into different VLANs, depending upon your network. VLANs can exist only inside the controller or they can extend outside the controller through 802.1q VLAN tagging.

You can optionally configure an IP address and netmask for a VLAN on the controller. The IP address is *up* when at least one physical port in the VLAN is up. The VLAN IP address can be used as a gateway by external devices; packets directed to a VLAN IP address that are not destined for the controller are forwarded according to the controller's IP routing table.

Creating and Updating VLANs

You can create and update a single VLAN or bulk VLANs.

In the WebUI

1. Navigate to the **Configuration > Network > VLANs** page.
2. Click **Add a VLAN** to create a new VLAN. (To edit an existing VLAN click **Edit** for the VLAN entry.) See ["Creating Bulk VLANs In the WebUI" on page 109](#) to create a range of VLANs.
3. In the **VLAN ID** field, enter a valid VLAN ID. (Valid values are from 1 to 4094, inclusive).
4. To add physical ports to the VLAN, select **Port**. To associate the VLAN with specific port-channels, select **Port-Channel**.
5. (Optional) Click the **Wired AAA Profile** drop-down list to assign an AAA profile to a VLAN. This wired AAA profile enables role-based access for wired clients connected to an untrusted VLAN or port on the controller.

Note that this profile will only take effect if the VLAN or port on the controller is untrusted. If you do not assign an wired AAA profile to the VLAN, the global wired AAA profile applies to traffic from untrusted wired ports.

6. If you selected **Port** in step 4, select the ports you want to associate with the VLAN from the **Port Selection** window.

-or-

If you selected **Port-Channel** in step 4, click the **Port-Channel ID** drop-down list, select the specific channel number you want to associate with the VLAN, then select the ports from the **Port Selection** window.

7. Click **Apply**.

In the CLI

```
(host) (config) #vlan <id>
(host) (config) #interface fastethernet|gigabitethernet <slot>/<port>
(host) (config-if) #switchport access vlan <id>
```

Creating Bulk VLANs In the WebUI

1. To add multiple VLANs at one time, click **Add Bulk VLANs**.
2. In the **VLAN Range** pop-up window, enter a range of VLANs you want to create at once. For example, to add VLAN IDs numbered 200-300 and 302-350, enter 200-300, 302-350.
3. Click **OK**.
4. To add physical ports to a VLAN, click **Edit** next to the VLAN you want to configure and click the port in the **Port Selection** section.
5. Click **Apply**.

In the CLI

```
(host) (config) #vlan
(host) (config) #vlan range 200-300,302-350
```

Creating Named VLANs

You can assign a name to a single VLAN ID whether it is part of a VLAN pool or not. A VLAN name must be between 1 and 32 characters and spaces are not allowed, thus allowing you to specify an individual VLAN by its name or ID or to the name of a VLAN pool to which a VLAN is assigned. *The VLAN name cannot be modified so choose the name carefully.* A VLAN name can also be assigned in a user rule, user role derivation, virtual AP profile and in a wired profile.

Creating a Named VLAN not in a Pool

The following configuration assigns the name **myvlan** to the VLAN ID 94.

In the WebUI

1. Navigate to **Configuration > Network > VLANs**.
2. Select the **VLAN Pool** tab to open the **VLAN Pool** window.
3. Click **Add**.
4. In the **VLAN Name** field, enter a name that identifies this VLAN.
5. Make sure the **Pool** field is unchecked. The **Assignment Type** is grayed out as this field applies only to VLAN pools.

Figure 28: Named VLAN not in a Pool

The screenshot shows a web interface titled "Add new VLAN name". It contains the following fields and controls:

- VLAN Name:** A text input field containing "myvlan".
- Assignment Type:** A dropdown menu set to "Hash".
- Pool:** A checkbox that is currently unchecked.
- List of VLAN IDs:** A text input field containing "94" and a dropdown menu also showing "94".
- Buttons:** "Add", "Cancel", and "Apply" buttons are located at the bottom of the form.

6. In the **List of VLAN IDs** field, enter the VLAN ID you want to name. If you know the ID, enter the ID. Or, click the drop-down list to view the IDs then click the <-- arrow to add the ID to the pool.
7. Click **Apply**.

In the CLI

This example assigns a name to an existing VLAN ID.

```
(host) (config) #vlan-name myvlan
(host) (config) #vlan myvlan 94
```

This example assigns a VLAN name in a virtual AP:

```
(host) (config) #wlan virtual-ap default vlan mygroup
```

This example assigns a VLAN name in a wired profile for access VLAN:

```
(host) (Wired AP profile "default") #switchport access vlan mygroup
```

This example assigns a VLAN name in a wired profile for a trunk VLAN and an allowed VLAN.

```
(host) (Wired AP profile "default") #switchport access vlan mygroup

(host) (config) #ap wired-ap-profile default switchport trunk ?
allowed          Set allowed VLAN characteristics when interface is
                  in trunking mode
native           Set trunking native characteristics when interface
                  is in trunking mode

(host) (config) #ap wired-ap-profile default switchport trunk native vlan mynativevlan

(host) (config) #ap wired-ap-profile default switchport trunk allowed vlan myallowedvlan
```

Creating a VLAN Pool

You can create, update and delete a VLAN pool. Each VLAN pool has a name and needs to have one or more VLANs assigned to it. The following configurations create a VLAN Pool named **mygroup**, it has the assignment type **Even**, and VLAN IDs 2, 4 and 12 are to this pool.

Using the WebUI

1. Navigate to **Configuration > Network > VLANs**.
2. Select the **VLAN Pool** tab to open the **VLAN Pool** window.
3. Click **Add**.
4. In the **VLAN Name** field, enter a name that identifies this VLAN pool.

- In the **Assignment Type** field, select **Hash** or **Even** from the drop-down menu. See ["Distinguishing Between Even and Hash Assignment Types"](#) on page 111 for information and conditions regarding Hash and Even assignment types

NOTE: The Even VLAN pool assignment type is only supported in tunnel and dtunnel modes. It is not supported in split or bridge modes. It is not allowed for VLAN pools that are configured directly under a virtual AP (VAP). It must only be used under named VLANs. L2 Mobility is not compatible with the existing implementation of the Even VLAN pool assignment type.

- Check the **Pool** check box if you want the VLAN to be part of a pool.
- In the **List of VLAN IDs** field, enter the VLAN IDs you want to add to this pool. If you know the ID, enter each ID separated by a comma. Or, click the drop-down list to view the IDs then click the <-- arrow to add the ID to the pool..

NOTE: VLAN pooling should *not* be used with static IP addresses.

- You must add two or more VLAN IDs to create a pool.
- When you finish adding all the IDs, click **Add**.

The VLAN pool along with its assigned IDs appears on the VLAN Pool window. If the pool is valid its status is enabled.

Figure 29: *Creating a VLAN Pool*

The screenshot shows the 'Network > VLAN Pool' configuration window. At the top, there are tabs for 'VLAN ID', 'VLAN Pool', and 'Spanning-tree'. Below the tabs is a table with the following data:

VLAN Name	Pool Status	Assignment Type	VLAN IDs	Action
Paula62	Disabled	N/A		Modify Delete

Below the table is a section titled 'Add new VLAN name' with the following fields:

- VLAN Name: mygroup
- Assignment Type: Even (dropdown)
- Pool:
- List of VLAN IDs: 2,4,12 (with a <-- arrow and a dropdown menu)

At the bottom of the form are 'Add', 'Cancel', and 'Apply' buttons.

- Click **Apply**.
- At the top of the window, click **Save Configuration**.

Distinguishing Between Even and Hash Assignment Types

The VLAN assignment type determines how a VLAN assignment is handled by the controller.

The Hash assignment type means that the VLAN assignment is based on the station MAC address. The Even assignment type is based on an even distribution of VLAN pool assignments.

The Even VLAN Pool assignment type maintains a dynamic latest usage level of each VLAN ID in the pool. Therefore, as users age out, the number of available addresses increases. This leads to a more even distribution of addresses.

The Even type is only supported in tunnel and dtunnel modes. It is not supported in split or bridge modes and it is not allowed for VLAN pools that are configured directly under a virtual AP. It can only be used under named VLANs.

If a VLAN pool is given an Even assignment and is assigned to user roles, user rules, VSA or a server derivation rules, then while applying VLAN derivation for the client “on run time,” the Even assignment is ignored and the Hash assignment is applied with a message displaying this change.



NOTE: L2 Mobility is not compatible with the existing implementation of the Even VLAN pool assignment type.

Updating a VLAN Pool

1. On the **VLAN Pool** window, click **Modify** next to the VLAN name you want to edit.
2. Modify the assignment type and the list of VLAN IDs. Note that you can not modify the VLAN name.
3. Click **Update**.
4. Click **Apply**.
5. At the top of the window, click **Save Configuration**.

Deleting a VLAN Pool

1. On the **VLAN Pool** window, click **Delete** next to the VLAN name you want to delete. A prompt appears.
2. Click **OK**.
3. Click **Apply**.
4. At the top of the window, click **Save Configuration**.

Creating a VLAN Pool Using the CLI



NOTE: VLAN pooling should *not* be used with static IP addresses.

This example creates a VLAN pool named **mygroup** that has the assignment type **even**.

```
(host) (config) #vlan-name mygroup pool assignment even
```

Viewing and Adding VLAN IDs Using the CLI

The following example shows how to view VLAN IDs to a VLAN pool:

```
(host) #configure terminal
Enter Configuration commands, one per line. End with CNTL/Z
(host) (config) #show vlan
```

```
VLAN CONFIGURATION
-----
VLAN   Description   Ports
-----
1      Default       FE1/0-3 FE1/6 GE1/8
2      VLAN0002
4      VLAN0004
12     VLAN0012
210    VLAN0210
212    VLAN0212      FE1/5
213    VLAN0213      FE1/4
1170   VLAN1170      FE1/7
1170   VLAN1170      FE1/7
```

The following example shows how to add existing VLAN IDs to a VLAN pool:

```
(host) #configure terminal
Enter Configuration commands, one per line. End with CNTL/Z
(host) (config) #vlan-name mygroup pool
(host) (config) #vlan mygroup 2,4,12
(host) (config) #
```

To confirm the VLAN pool status and mappings assignments, use the `show vlan mapping` command:

```
(TechPubs650) (config) #show vlan mapping

Vlan Mapping Table
-----
VLAN Name      Pool Status  Assignment Type  VLAN IDs
-----
mygroup        Enabled     Hash             62,94
newpoolgroup   Enabled     Even
vlannametest   Enabled     Even             62,1511
```

Adding a Bandwidth Contract to the VLAN

Bandwidth contracts on a VLAN can limit broadcast and multicast traffic. ArubaOS includes an internal exception list to allow broadcast and multicast traffic using the VRRP, LACP, OSPF, PVST and STP protocols. To remove per-VLAN bandwidth contract limits on an additional broadcast or multicast protocol, add the MAC address for that broadcast/multicast protocol to the VLAN Bandwidth Contracts MAC Exception List.

The command in the example below adds the MAC address for CDP (Cisco Discovery Protocol) and VTP (Virtual Trunking Protocol) to the list of protocols that are not limited by VLAN bandwidth contracts.

```
(host) (config) #vlan-bwcontract-explist mac 01:00:0C:CC:CC:CC
```

To show entries in the VLAN bandwidth contracts MAC exception list, use the `show vlan-bwcontract-explist [internal]` command:

```
(host) (config) #show vlan-bwcontract-explist internal

VLAN BW Contracts Internal MAC Exception List
-----
MAC address
-----
01:80:C2:00:00:00
01:00:0C:CC:CC:CD
01:80:C2:00:00:02
01:00:5E:00:82:11
```

Optimizing VLAN Broadcast and Multicast Traffic

Broadcast and Multicast (BCMC) traffic from APs, remote APs, or distributions terminating on the same VLAN floods all VLAN member ports. This causes critical bandwidth wastage especially when the APs are connected to L3 cloud where the available bandwidth is limited or expensive. Suppressing the VLAN BCMC traffic to prevent flooding can result in loss of client connectivity.

To effectively prevent flooding of BCMC traffic on all VLAN member ports, use the `bcmc-optimization` parameter under the `interface vlan` command. This parameter ensures controlled flooding of BCMC traffic without compromising the client connectivity. By default this option is disabled. You must enable this parameter for the controlled flooding of BCMC traffic.



NOTE: If BCMC Optimization is enabled on uplink ports, the controller-generated Layer-2 packets will be dropped.

The **bcmc-optimization** parameter has the following exemptions:

- All DHCP traffic will continue to flood VLAN member ports even if the **bcmc-optimization** parameter is enabled.
- ARP broadcasts and VRRP (multicast) traffic will still be allowed.

You can configure BCMC optimization using the CLI or WebUI.

Using the CLI

```
(host) (config) #interface vlan 1
(host) (config-subif)#bcmc-optimization
(host) (config-subif)#show interface vlan 1
```

```
VLAN1 is up line protocol is up
Hardware is CPU Interface, Interface address is 00:0B:86:61:5B:98 (bia 00:0B:86:61:5B:98)
Description: 802.1Q VLAN
Internet address is 10.17.22.1 255.255.255.0
Routing interface is enable, Forwarding mode is enable
Directed broadcast is disabled, BCMC Optimization enable
Encapsulation 802, loopback not set
MTU 1500 bytes
Last clearing of "show interface" counters 12 day 1 hr 4 min 12 sec
link status last changed 12 day 1 hr 2 min 21 sec
```

Proxy Arp is disabled for the Interface

Using the WebUI

1. Navigate to **Configuration > Network > IP**.
2. In the **IP Interfaces** tab, click the **Edit** button of the VLAN for configuring BCMC optimization.
3. Select **Enable BCMC** check box to enable BCMC Optimization for the selected VLAN.

Figure 30: Enable BCMC Optimization

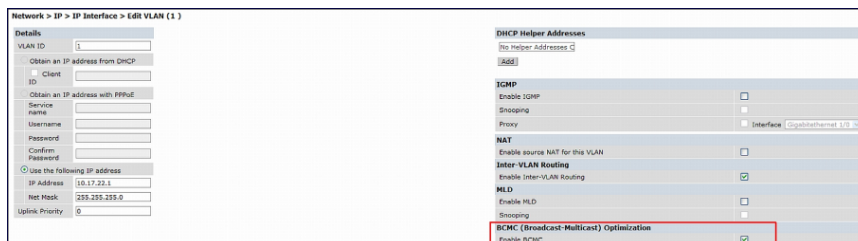

Configuring Ports

Both Fast Ethernet and Gigabit Ethernet ports can be set to access or trunk mode. By default, a port is in access mode and carries traffic only for the VLAN to which it is assigned. In trunk mode, a port can carry traffic for multiple VLANs.

For a trunk port, specify whether the port will carry traffic for all VLANs configured on the controller or for specific VLANs. You can also specify the native VLAN for the port. A trunk port uses 802.1q tags to mark frames for specific VLANs, However, frames on a native VLAN are not tagged.

Classifying Traffic as Trusted or Untrusted

You can classify wired traffic based not only on the incoming physical port and channel configuration but also on the VLAN associated with the port and channel.

About Trusted and Untrusted Physical Ports

By default, physical ports on the controller are trusted and are typically connected to internal networks while untrusted ports connect to third-party APs, public areas, or other networks to which access controls can be applied. When you define a physical port as untrusted, traffic passing through that port needs to go through a predefined access control list policy.

About Trusted and Untrusted VLANs

You can also classify traffic as trusted or untrusted based on the VLAN interface and port/channel. This means that wired traffic on the incoming port is trusted only when the port's associated VLAN is also trusted, otherwise the traffic is untrusted. When a port and its associated VLANs are untrusted, any incoming and outgoing traffic must pass through a predefined ACL. For example, this setup is useful if your company provides wired user guest access and you want guest user traffic to pass through an ACL to connect to a captive portal.

You can set a range of VLANs as trusted or untrusted in trunk mode. The following table lists the port, VLAN and the trust/untrusted combination to determine if traffic is trusted or untrusted. Both the port and the VLAN have to be configured as trusted for traffic to be considered as trusted. If the traffic is classified as untrusted then traffic must pass through the selected session access control list and firewall policies.

Table 31: *Classifying Trusted and Untrusted Traffic*

Port	VLAN	Traffic Status
Trusted	Trusted	Trusted
Untrusted	Untrusted	Untrusted
Untrusted	Trusted	Untrusted
Trusted	Untrusted	Untrusted

Configuring Trusted/Untrusted Ports and VLANs

You can configure an Ethernet port as an untrusted access port, assign VLANs and make them untrusted, and designate a policy through which VLAN traffic on this port must pass.

In the WebUI

1. Navigate to the **Configuration > Network > Ports** window.
2. In the **Port Selection** section, click the port you want to configure.
3. In the **Make Port Trusted** section, clear the **Trusted** check box to make the port untrusted. The default is trusted (checked).
4. In the **Port Mode** section, select **Access**.
5. From the **VLAN ID** drop-down list select the **VLAN ID** whose traffic will be carried by this port.
6. In the **Enter VLAN(s)** section, clear the **Trusted** check box to make the VLAN untrusted. The default is trusted (checked).
7. In the **VLAN Firewall Policy** drop-down list, select the policy through which VLAN traffic must pass. You can select a policy for both trusted and untrusted VLANs.

8. From the **Firewall Policy** section, select the policy from the **in** drop-down list through which inbound traffic on this port must pass.
9. Select the policy from the **out** drop-down list through which outbound traffic on this port must pass.
10. Select the policy To apply a policy to this session's traffic on this port and VLAN, select the policy from the **session** drop-down list.
11. Click **Apply**.

In the CLI

In this example,

```
(host) (config) #interface range fastethernet 1/2
(host) (config-if) #switchport mode access
(host) (config-if) #no trusted
(host) (config-if) #switchport access vlan 2
(host) (config-if) #no trusted vlan 2
(host) (config-if) #ip access-group ap-acl session vlan 2
(host) (config-if) #ip access-group validuserethacl in
(host) (config-if) #ip access-group validuserethacl out
(host) (config-if) #ip access-group validuser session
```

Configuring Trusted and Untrusted Ports and VLANs in Trunk Mode

The following procedures configure a range of Ethernet ports as untrusted native trunks ports, assign VLANs and make them untrusted and designate a policy through which VLAN traffic on the ports must pass.

In the WebUI

1. Navigate to the **Configuration > Network > Ports** window.
2. In the **Port Selection** section, click the port you want to configure.
3. For **Port Mode** select **Trunk**.
4. To specify the native VLAN, select a VLAN from the **Native VLAN** drop-down list and click the <-- arrow.
5. Choose one of the following options to control the type of traffic the port carries:
 - **Allow All VLANs Except**– The port carries traffic for all VLANs except the ones from this drop-down list.
 - **Allow VLANs** – The port carries traffic for all VLANs selected from this drop-down list.
 - **Remove VLANs** – The port does not carry traffic for any VLANs selected from this drop-down list.
6. To designate *untrusted* VLANs on this port, click **Trusted except**. In the corresponding VLAN field enter a range of VLANs that you want to make *untrusted*. (In this format, for example: 200-300, 401-500 and so on). Only VLANs listed in this range are untrusted. Or, to make only one VLAN untrusted, select a VLAN from the drop-down menu.
7. To designate *trusted* VLANs on this port, click **Untrusted except**. In the corresponding VLAN field enter a range of VLANs that you want to make *trusted*. (In this format, for example: 200-300, 401-500 and so on). Only VLANs listed in this range are trusted. Or, to make only one VLAN trusted, select a VLAN from the drop-down menu.
8. To remove a VLAN, click the **Remove VLANs** option and select the VLAN you want to remove from the drop-down list and click the left arrow to add it to the list.
9. To designate the policy through which VLAN traffic must pass, click **New** under the **Session Firewall Policy** field.
10. Enter the VLAN ID or select it from the associated drop-down list. Then select the policy, through which the VLAN traffic must pass, from the **Policy** drop-down list and click **Add**. Both the selected VLAN and the policy appear in the **Session Firewall Policy** field.

11. When you are finished listing VLAN and policies, click **Cancel**.
12. Click **Apply**.

In the CLI

```
(host) (config) #interface fastethernet 2/0
(host) (config-if)#description FE2/
(host) (config-if)#trusted vlan 1-99,101, 104, 106-199, 201-299
(host) (config-range) # switchport mode trunk
(host) (config-if)#switchport trunk native vlan 100
(host) (config-range) # ip access-group
(host) (config-range) # ip access-group test session vlan 2
```

Understanding VLAN Assignments

A client is assigned to a VLAN by one of several methods. There is an order of precedence by which VLANs are assigned. The assignment of VLANs are (from lowest to highest precedence):

1. The default VLAN is the VLAN configured for the WLAN (see ["Configuring Virtual AP Profiles" on page 315](#)).
2. Before client authentication, the VLAN can be derived from rules based on client attributes (SSID, BSSID, client MAC, location, and encryption type). A rule that derives a specific VLAN takes precedence over a rule that derives a user role that may have a VLAN configured for it.
3. After client authentication, the VLAN can be the VLAN configured for a default role for an authentication method, such as 802.1x or VPN.
4. After client authentication, the VLAN can be derived from attributes returned by the authentication server (*server-derived rule*). A rule that derives a specific VLAN takes precedence over a rule that derives a user role that may have a VLAN configured for it.
5. After client authentication, the VLAN can be derived from Microsoft Tunnel attributes (Tunnel-Type, Tunnel Medium Type, and Tunnel Private Group ID). All three attributes must be present as shown below. This does not require any server-derived rule.

```
Tunnel-Type="VLAN" (13)
Tunnel-Medium-Type="IEEE-802" (6)
Tunnel-Private-Group-Id="101"
```

6. After client authentication, the VLAN can be derived from Vendor Specific Attributes (VSA) for RADIUS server authentication. This does not require any server-derived rule. If a VSA is present, it overrides any previous VLAN assignment. For example:

```
Dell-User-VLAN
Dell-Named-User-VLAN
```

How a VLAN Obtains an IP Address

A VLAN on the controller obtains its IP address in one of the following ways:

- Manually configured by the network administrator. This is the default method and is described in ["Assigning a Static Address to a VLAN" on page 117](#). At least one VLAN on the controller must be assigned a static IP address.
- Dynamically assigned from a Dynamic Host Configuration Protocol (DHCP) or Point-to-Point Protocol over Ethernet (PPPoE) server.

Assigning a Static Address to a VLAN

You can manually assign a static IP address to a VLAN on the controller. At least one VLAN on the controller must be assigned a static IP address.

In the WebUI

1. Navigate to the **Configuration > Network > IP > IP Interfaces** page on the WebUI. Click **Edit** for the VLAN you just added.
2. Select the **Use the following IP address** option. Enter the IP address and network mask of the VLAN interface. If required, you can also configure the address of the DHCP server for the VLAN by clicking **Add**.
3. Click **Apply**.

In the CLI

```
(host) (config) #interface vlan <id>  
    ip address <address> <netmask>
```

Configuring a VLAN to Receive a Dynamic Address

In a branch office, you can connect a controller to an uplink switch or server that dynamically assigns IP addresses to connected devices. For example, the controller can be connected to a DSL or cable modem, or a broadband remote access server (BRAS).  shows a branch office where a controller connects to a cable modem. VLAN 1 has a static IP address, while VLAN 2 has a dynamic IP address assigned via DHCP or PPPoE from the uplink device.

Figure 32: IP Address Assignment to VLAN via DHCP or PPPoE



Configuring Multiple Wired Uplink Interfaces (Active-Standby)

You can assign up to four VLAN interfaces to operate in active-standby topology. An active-standby topology provides redundancy so that when an active interface fails, the user traffic can failover to the standby interface.

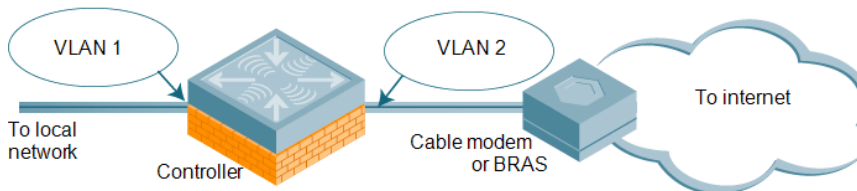
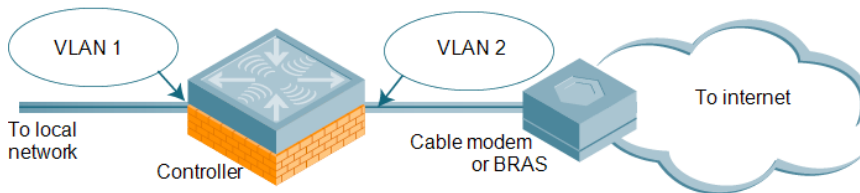
To allow the controller to obtain a dynamic IP address for a VLAN, enable the DHCP or PPPoE client on the controller for the VLAN.

The following restrictions apply when enabling the DHCP or PPPoE client on the controller:

- You can enable the DHCP/PPPoE client multiple uplink VLAN interfaces (up to four) on the controller; these VLANs cannot be VLAN 1.
- Only one port in the VLAN can be connected to the modem or uplink switch.
- At least one interface in the VLAN must be in the up state before the DHCP/PPPoE client requests an IP address from the server.

Enabling the DHCP Client

The DHCP server assigns an IP address for a specified amount of time called a lease. The controller automatically renews the lease before it expires. When you shut down the VLAN, the DHCP lease is released.

In the WebUI

1. Navigate to the **Configuration > Network > IP > IP Interfaces** page.
2. Click **Edit** for a previously-created VLAN.
3. Select **Obtain an IP address from DHCP**.

4. Enter a priority value for the VLAN ID in the **Uplink Priority** field. By default, all wired uplink interfaces have the same priority. If you want to use an active-standby topology then prioritize each uplink interfaces by entering a different priority value (1– 4) for each uplink interface.

Figure 33: Assigning VLAN uplink priority—Active-Standby configuration

The screenshot shows the configuration page for VLAN 62. The breadcrumb navigation is 'Network > IP > IP Interface > Edit VLAN (62)'. The 'Details' section includes the following fields and options:

- VLAN ID: 62
- Obtain an IP address from DHCP
 - Client ID: [Empty field]
- Obtain an IP address with PPPoE
 - Service name: [Empty field]
 - Username: [Empty field]
 - Password: [Empty field]
 - Confirm Password: [Empty field]
- Use the following IP address
 - IP Address: [Empty field]
 - Net Mask: [Empty field]
- Uplink Priority: 2

5. Click **Apply**.

In the CLI

In this example, the DHCP client has the client ID name *myclient* and the interface VLAN 62 has an uplink priority of 2.

```
interface vlan 62
uplink wired vlan 62 priority 3
interface vlan 62 ip address dhcp-client client-id myclient
```

Enabling the PPPoE Client

To authenticate to the BRAS and request a dynamic IP address, the controller must have the following configured:

- PPPoE user name and password to connect to the DSL network
- PPPoE service name — either an ISP name or a class of service configured on the PPPoE server

When you shut down the VLAN, the PPPoE session terminates.

In the WebUI

1. Navigate to the **Configuration > Network > IP > IP Interfaces** page.
2. Click **Edit** for a previously-created VLAN.
3. Select **Obtain an IP address with PPPoE**.
4. Enter the service name, username, and password for the PPPoE session.

5. Enter a priority value for the VLAN ID in the **Uplink Priority** field. By default, all wired uplink interfaces have the same priority. If you want to use an active-standby topology then prioritize each uplink interfaces by entering a different priority value (1– 4) for each uplink interface.
6. Click **Apply**.

In the CLI

In this example, a PPOE service name, username and password are assigned. The interface VLAN 14 has an uplink priority of 3.

```
(host) (config) #interface vlan 14
    ip address pppoe
(host) (config) #interface vlan 14 ip pppoe-service-name <service_name>
(host) (config) #interface vlan 14 ip pppoe-username <username>
(host) (config) #interface vlan 14 ip pppoe-password *****
(host) (config) #uplink wired vlan 14 priority 3
```

Default Gateway from DHCP/PPPoE

You can specify that the router IP address obtained from the DHCP or PPPoE server be used as the default gateway for the controller.

In the WebUI

1. Navigate to the **Configuration > Network > IP > IP Routes** page.
2. For Default Gateway, select **(Obtain an IP address automatically)**.
3. Select **Apply**.

In the CLI

```
(host) (config) #ip default-gateway import
```

Configuring DNS/WINS Server from DHCP/PPPoE

The DHCP or PPPoE server can also provide the IP address of a DNS server or NetBIOS name server, which can be passed to wireless clients through the controller's internal DHCP server.

For example, the following configures the DHCP server on the controller to assign addresses to authenticated employees; the IP address of the DNS server obtained by the controller via DHCP/PPPoE is provided to clients along with their IP address.

In the WebUI

1. Navigate to the **Configuration > Network > IP > DHCP Server** page.
2. Select **Enable DHCP Server**.
3. Under Pool Configuration, select **Add**.
4. For Pool Name, enter **employee-pool**.
5. For Default Router, enter **10.1.1.254**.
6. For DNS Servers, select **Import from DHCP/PPPoE**.
7. For WINS Servers, select **Import from DHCP/PPPoE**.
8. For Network, enter **10.1.1.0** for IP Address and **255.255.255.0** for Netmask.
9. Click **Done**.

In the CLI

```
(host) (config) #ip dhcp pool employee-pool
```



```
d>default-router 10.1.1.254
d>ns-server import
netbios-name-server import
network 10.1.1.0 255.255.255.0
```

Configuring Source NAT to Dynamic VLAN Address

When a VLAN interface obtains an IP address through DHCP or PPPoE, a NAT pool (dynamic-srcnat) and a session ACL (dynamic-session-acl) are automatically created which reference the dynamically-assigned IP addresses. This allows you to configure policies that map private local addresses to the public address(es) provided to the DHCP or PPPoE client. Whenever the IP address on the VLAN changes, the dynamic NAT pool address also changes to match the new address.

For example, the following rules for a guest policy deny traffic to internal network addresses. Traffic to other (external) destinations are source NATed to the IP address of the DHCP/PPPoE client on the controller.

In the WebUI

1. Navigate to the **Configuration > Security > Access Control > Policies** page. Click **Add** to add the policy **guest**.
2. To add a rule, click **Add**.
 - a. For Source, select **any**.
 - b. For Destination, select **network** and enter 10.1.0.0 for Host IP and 255.255.0.0 for Mask.
 - c. For Service, select **any**.
 - d. For Action, select **reject**.
 - e. Click **Add**.
3. To add another rule, click **Add**.
 - a. Leave Source, Destination, and Service as **any**.
 - b. For Action, select **src-nat**.
 - c. For NAT Pool, select **dynamic-srcnat**.
 - d. Click **Add**.
4. Click **Apply**.

In the CLI

```
(host) (config) #ip access-list session guest
any network 10.1.0.0 255.255.0.0 any deny
any any any src-nat pool dynamic-srcnat
```

Configuring Source NAT for VLAN Interfaces

The example configuration in the previous section illustrates how to configure source NAT using a policy that is applied to a user role. You can also enable source NAT for a VLAN interface to cause NAT to be performed on the source address for *all* traffic that exits the VLAN.

Packets that exit the VLAN are given a source IP address of the “outside” interface, which is determined by the following:

- If you configure “private” IP addresses for the VLAN, the controller is assumed to be the default gateway for the subnetwork. Packets that exit the VLAN are given the IP address of the controller for their source IP address.
- If the controller is forwarding the packets at Layer-3, packets that exit the VLAN are given the IP address of the next-hop VLAN for their source IP address.

Example Configuration

In the following example, the controller operates within an enterprise network. VLAN 1 is the outside VLAN. Traffic from VLAN 6 is source NATed using the IP address of the controller. In this example, the IP address assigned to VLAN 1 is used as the controller's IP address; thus traffic from VLAN 6 would be source NATed to 66.1.131.5.

Figure 34: Example: Source NAT using Controller IP Address

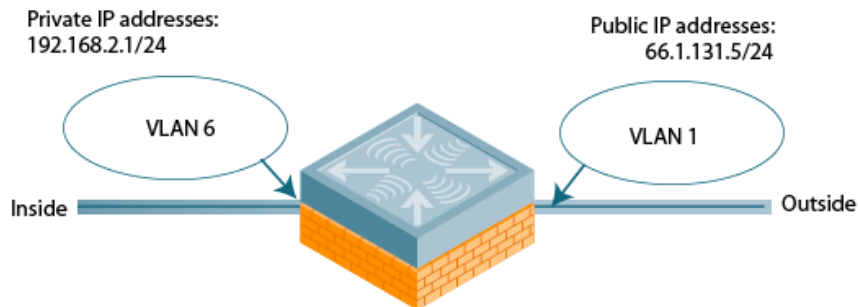

In the WebUI

1. Navigate to the **Configuration > Network > VLANs** page. Click **Add** to configure VLAN 6 (VLAN 1 is configured through the Initial Setup).
 - a. Enter 6 for the VLAN ID.
 - b. Click **Apply**.
2. Navigate to the **Configuration > Network > IP > IP Interfaces** page.
3. Click **Edit** for VLAN 6:
 - a. Select **Use the following IP address**.
 - b. Enter 192.168.2.1 for the IP Address and 255.255.255.0 for the Net Mask.
 - c. Select the **Enable source NAT for this VLAN** checkbox.
4. Click **Apply**.

In the CLI

```
(host) (config) #interface vlan 1
ip address 66.1.131.5 255.255.255.0
(host) (config) #interface vlan 6
(host) (config) #ip address 192.168.2.1 255.255.255.0
ip nat inside
ip default-gateway 66.1.131.1
```

Inter-VLAN Routing

On the controller, you can map a VLAN to a layer-3 subnetwork by assigning a static IP address and netmask or by configuring a DHCP or PPPoE server to provide a dynamic IP address and netmask to the VLAN interface. The controller, acting as a layer-3 switch, routes traffic between VLANs that are mapped to IP subnetworks; this forwarding is enabled by default.

In [Figure 35](#), VLAN 200 and VLAN 300 are assigned the IP addresses 2.1.1.1/24 and 3.1.1.1/24, respectively. Client A in VLAN 200 is able to access server B in VLAN 300 and vice versa, provided that there is no firewall rule configured on the controller to prevent the flow of traffic between the VLANs.

Figure 35: Default Inter-VLAN Routing

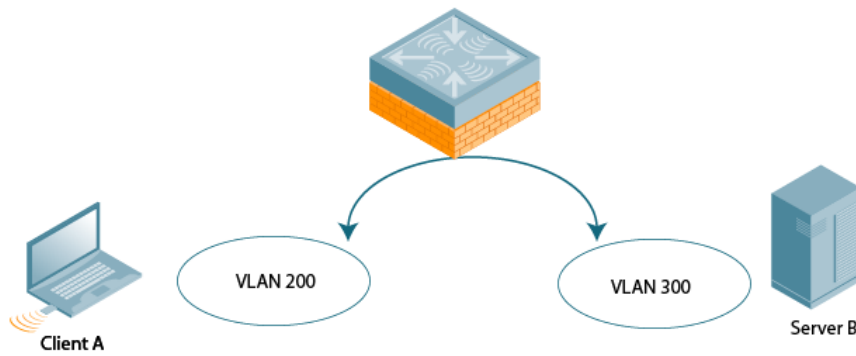

You can optionally disable layer-3 traffic forwarding to or from a specified VLAN. When you disable layer-3 forwarding on a VLAN, the following restrictions apply:

- Clients on the restricted VLAN can ping each other, but cannot ping the VLAN interface on the controller. Forwarding of inter-VLAN traffic is blocked.
- IP mobility does not work when a mobile client roams to the restricted VLAN. You must ensure that a mobile client on a restricted VLAN is not allowed to roam to a non-restricted VLAN. For example, a mobile client on a guest VLAN should not be able to roam to a corporate VLAN.

To disable layer-3 forwarding for a VLAN configured on the controller:

Using the WebUI to restrict VLAN routing

1. Navigate to the **Configuration > Network > IP > IP Interface** page.
2. Click **Edit** for the VLAN for which routing is to be restricted.
3. Configure the VLAN to either obtain an IP address dynamically (via DHCP or PPPoE) or to use a static IP address and netmask.
4. Deselect (uncheck) the **Enable Inter-VLAN Routing** checkbox.
5. Click **Apply**.

Using the CLI

```
interface vlan <id>
  ip address {<ipaddr> <netmask>|dhcp-client|pppoe}
  no ip routing
```

Configuring Static Routes

To configure a static route (such as a default route) on the controller, do the following:

In the WebUI

1. Navigate to the **Configuration > Network > IP > IP Routes** page.
2. Click **Add** to add a static route to a destination network or host. Enter the destination IP address and network mask (255.255.255.255 for a host route) and the next hop IP address.
3. Click **Done** to add the entry. Note that the route has not yet been added to the routing table.
4. Click **Apply** to add this route to the routing table. The message **Configuration Updated Successfully** confirms that the route has been added.

In the CLI

```
(host) (config) #ip route <address> <netmask> <next_hop>
```

Configuring the Loopback IP Address

The loopback IP address is a logical IP interface that is used by the controller to communicate with APs. The loopback address is used as the controller's IP address for terminating VPN and GRE tunnels, originating requests to RADIUS servers and accepting administrative communications. You configure the loopback address as a host address with a 32-bit netmask. The loopback address is not bound to any specific interface and is operational at all times. To use this interface, ensure that the IP address is reachable through one of the VLAN interfaces. It should be routable from all external networks.

You must configure a loopback address if you are not using VLAN1 to connect the controller to the network. If the loopback interface address is not configured then the first configured VLAN interface address is selected. Generally, VLAN 1 is the factory default setting and thus becomes the controller IP address

In the WebUI

1. Navigate to the **Configuration > Network > Controller > System Settings** page and locate the **Loopback Interface** section.
2. Modify the **IP Address** as required.
3. Click



NOTE: If you are using the loopback IP address to access the WebUI, changing the loopback IP address will result in loss of connectivity. Dell recommends that you use one of the VLAN interface IP addresses to access the WebUI.

4. **Apply**.
5. Navigate to the **Maintenance > Controller > Reboot Controller** page to reboot the controller to apply the change of loopback IP address.
6. Click **Continue** to save the configuration.
7. When prompted that the changes were written successfully to flash, click **OK**.

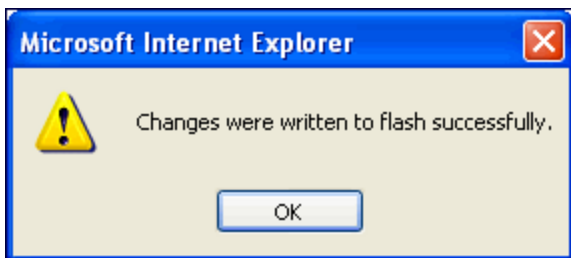

8. The controller boots up with the changed loopback IP address.

In the CLI

```
(host) (config) #interface loopback ip address <address>  
(host) (config) #write memory
```

Enter the following command in Enable mode to reboot the controller :

```
(host) #reload
```

Configuring the Controller IP Address

The Controller IP address is used by the controller to communicate with external devices such as APs.

You can set the Controller IP address to the loopback interface address or to an existing VLAN ID address. This allows you to force the controller IP address to be a specific VLAN interface or loopback address across multiple machine reboots. Once you configure an interface to be the controller IP address, that interface address cannot be deleted until you remove it from the controller IP configuration.

If the controller IP address is not configured then the controller IP defaults to the current loopback interface address. If the loopback interface address is not configured then the first configured VLAN interface address is selected. Generally, VLAN 1 is the factory default setting and thus becomes the controller IP address.

Using the WebUI:

1. Navigate to the **Configuration > Network > Controller > System Settings** page.
2. Locate the **Controller IP Details** section.
3. Select the address you want to set the Controller IP to from the **VLAN ID** drop-down menu. This list only contains VLAN IDs that have statically assigned IP addresses. If a loopback interface IP address has been previously configured then it will also appear in this list. Dynamically assigned IP addresses, for example DHCP/PPPOE do not display.
4. Click **Apply**.



NOTE: Any change in the controller's IP address requires a reboot.

5. Navigate to the **Maintenance > Controller > Reboot Controller** page to reboot the controller to apply the change of controller IP address.
6. Click **Continue** to save the configuration.
7. When prompted that the changes were written successfully to flash, click **OK**.



8. The controller boots up with the changed controller IP address. of the selected VLAN ID.

Using the CLI

```
(host) (config) #controller-ip [loopback|vlan <VLAN ID>]
```

Configuring GRE Tunnels

A controller supports generic routing encapsulation (GRE) tunnels between the controller and APs. An AP opens a GRE tunnel to the controller for each radio interface. On the AP, the other end of the GRE tunnel is specified by the IP address configured variable values (in descending order of priority) `<master>`, `<servername>`, and `<serverip>`. If these variable are left to default values, the AP uses DNS to look up Alcatel-Lucent-master to discover the IP address of the controller.

The controller also supports GRE tunnels between the controller and other GRE-capable devices. This section describes how to configure a GRE tunnel to such a device and how to direct traffic into the tunnel.



NOTE: The controller uses GRE tunnels for communications between master and local Dell controllers; these GRE tunnels are automatically created and are not subject to the configuration described in this section.

Creating a Tunnel Interface

To create a GRE tunnel on the controller, you need to specify the following:

- Tunnel ID: this can be a number between 1 and 2147483647.
- IP address and netmask for the tunnel.
- Tunnel source: the local endpoint for the tunnel on the controller. This can be one of the following:
 - Loopback address of the controller
 - A specified IP address
 - A specified VLAN
- Tunnel destination: the IP address of the remote endpoint of the tunnel on the other GRE device.

In the WebUI

1. Navigate to the **Configuration > Network > IP > GRE Tunnels** page.
2. Click **Add**.
3. Enter the tunnel ID.
4. Enter the IP address and netmask for the tunnel.
5. Select (check) **Enabled** to enable the tunnel interface.
6. Select the tunnel source, if it is not the loopback address of the controller. If you select **IP Address**, enter the IP address for the tunnel source. If you select **VLAN**, select the ID of the VLAN.
7. Enter the IP address of the tunnel destination.
8. Click **Apply**.

In the CLI

```
(host) (config) #interface tunnel <id>
  tunnel mode gre <num> <ip>
  ip address <ipaddr> <netmask>
  no shutdown
  tunnel source {<ipaddr>| loopback | vlan <vlan>}
  tunnel destination <ipaddr>
```

Directing Traffic into the Tunnel

You can direct traffic into the tunnel by configuring one of the following:

- Static route, which redirects traffic to the IP address of the tunnel
- Firewall policy (session-based ACL), which redirects traffic to the specified tunnel ID

Static Routes

You can configure a static route that specifies the IP address of a tunnel as the next-hop for traffic for a specific destination. See ["Configuring Static Routes" on page 123](#) for descriptions of how to configure a static route.

Firewall Policy

You can configure a firewall policy rule to redirect selected traffic into a tunnel.

Traffic redirected by a firewall policy rule is *not* forwarded to a tunnel that is “down” (see ["Tunnel Keepalives" on page 127](#) for more information on how GRE tunnel status is determined). If you have more than one GRE tunnel configured, you can create multiple firewall policy rules with each rule redirecting the same traffic to different tunnels. If the tunnel in the first traffic redirect rule is down, then the tunnel in the subsequent traffic redirect rule is used instead.

In the WebUI

1. Navigate to the **Configuration > Security > Access Control > Policies** page.
2. Click **Add** to create a new firewall policy, or click **Edit** to edit a specific policy.
3. Click **Add** to create a new policy rule.
4. Configure the Source, Destination, and Service for the rule.
5. For Action, select redirect to tunnel. Enter the tunnel ID.
6. Configure any additional options, and click **Add**.
7. Click **Apply**.

In the CLI

```
(host) (config) #ip access-list session <name>
    <source> <destination> <service> redirect tunnel <id>
```

Tunnel Keepalives

The controller can determine the status of a GRE tunnel by sending periodic keepalive frames on the L2 or L3 GRE tunnel. If you enable tunnel keepalives, the tunnel is considered to be “down” if there is repeated failure of the keepalives. If you configured a firewall policy rule to redirect traffic to the tunnel, traffic is not forwarded to the tunnel until it is “up”. When the tunnel comes up or goes down, an SNMP trap and logging message is generated. The remote endpoint of the tunnel does not need to support the keepalive mechanism.

By default, the controller sends keepalive frames at 60-second intervals and retries keepalives up to three times before the tunnel is considered to be down. You can reconfigure the intervals from the default. For the interval, specify a value between 1-86400 seconds. For the retries, specify a value between 0-1024.

In the WebUI

1. Navigate to the **Configuration > Network > IP > GRE Tunnels** page.
2. Click **Edit** for the tunnel for which you are enabling tunnel keepalives.
3. Select (check) **Enable Heartbeats** to enable tunnel keepalives and display the Heartbeat Interval and Heartbeat Retries fields.
4. Enter values for Heartbeat Interval and Heartbeat Retries.
5. Click **Apply**.

In the CLI

```
(host) (config) #interface tunnel id
    tunnel keepalive [<interval> <retries>]
```

Chapter 8

IPv6 Support

This chapter describes ArubaOS support for IPv6 features.

- ["Understanding IPv6 Notation" on page 128](#)
- ["Understanding IPv6 Topology" on page 128](#)
- ["Enabling IPv6" on page 129](#)
- ["Enabling IPv6 Support for Controller and APs" on page 129](#)
- ["Filtering an IPv6 Extension Header \(EH\)" on page 136](#)
- ["Configuring a Captive Portal over IPv6" on page 136](#)
- ["Working with IPv6 Router Advertisements \(RAs\)" on page 136](#)
- ["Understanding ArubaOS Supported Network Configuration for IPv6 Clients" on page 140](#)
- ["Managing IPv6 User Addresses" on page 146](#)
- ["Understanding IPv6 Exceptions and Best Practices" on page 146](#)

Understanding IPv6 Notation

The IPv6 protocol is the next generation of large-scale IP networks by supporting addresses that are 128 bits long. This allows 2^{128} possible addresses (versus 2^{32} possible IPv4 addresses).

Typically, the IP address assigned on an IPv6 host consists of a 64-bit subnet identifier and a 64-bit interface identifier. IPv6 addresses are represented as eight colon-separated fields of up to four hexadecimal digits each. The following are examples of IPv6 addresses:

```
FEDC:BA98:7654:3210:FEDC:BA98:7654:3210  
1080:0:0:0:0:800:200C:417A
```

The use of the "::" symbol is a special syntax that you can use to compress one or more 16-bit groups of zeros or to compress leading or trailing zeros in an address. The "::" can appear only once in an address. For example, the address, 1080:0:0:0:0:800:200C:417A can also be represented as 1080::800:200C:417A.

IPv6 uses subnet identifiers to identify subnetworks to which nodes are attached. In ArubaOS, when you refer IPv6 subnetworks in firewall policies, you must specify a subnet mask in addition to the IPv6 address. The subnet mask is a bitmask that specifies the prefix length. For example, 1080::800:200C:417A ffff:ffff:ffff:ffff:: represents all IPv6 addresses with the subnet identifier 1080:0:0:0.

Understanding IPv6 Topology

IPv6 APs connect to the IPv6 controller over an IPv6 L3 network. The IPv6 controller can terminate both IPv4 and IPv6 APs. IPv4 and IPv6 clients can terminate to either IPv4 or IPv6 APs. ArubaOS supports Router Advertisements (RA). You do not need an external IPv6 router in the subnet to generate RA for IPv6 APs and clients that depend on stateless autoconfiguration to obtain IPv6 address. The external IPv6 router is the default gateway in most deployments. However, the controller can be the default gateway by using static routes. The master-local communication always happens in IPv4.

The following image illustrates how IPv6 clients, APs, and controller communicate with each other in an IPv6 network.

Figure 36: IPv6 Topology

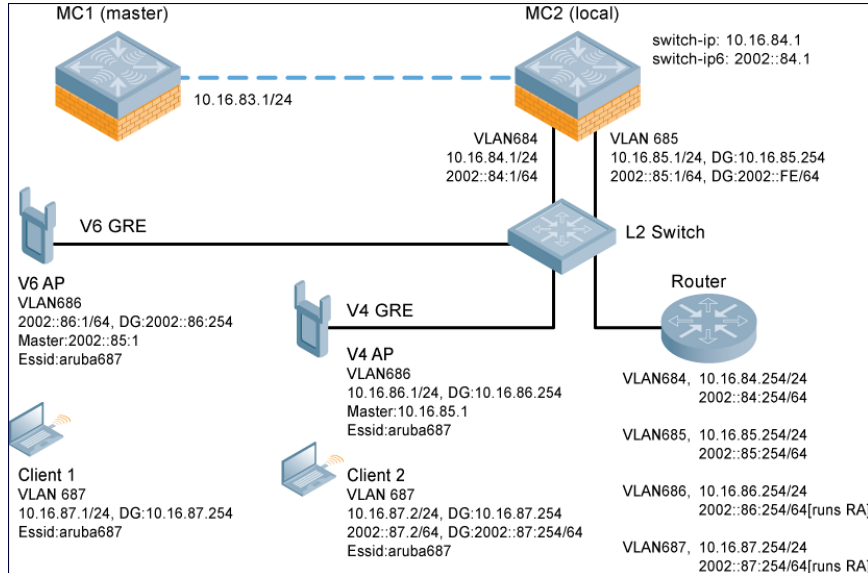

- The IPv6 controller (MC2) terminates both V4 AP (IPv4 AP) and V6 AP (IPv6 AP).
- Client 1 (IPv4 client) terminates to V6 AP and Client 2 (IPv6 client) terminates to V4 AP.
- Router is an external IPv6 router in the subnet that acts as the default gateway in this illustration.
- MC1 (master) and MC2 (local) communicates in IPv4.

Enabling IPv6

You must enable the IPv6 option on the controller before using any of the IPv6 functions. You can use the `ipv6 enable` command to enable the IPv6 packet/firewall processing on the controller. By default, the IPv6 option is disabled.

You can also use the WebUI to enable the IPv6 option as follows:

1. Navigate to the **Configuration > Advanced Services > Stateful Firewall** page.
2. Select the **Global Settings** tab.
3. Select the **IPv6 Enable** check box to enable the IPv6 option.
4. Click the **Apply** button to apply the configuration.

Enabling IPv6 Support for Controller and APs

This release of ArubaOS provides IPv6 support for controller and access points. You can now configure the master controller with an IPv6 address to manage the Dell controllers and APs. Both IPv4 and IPv6 APs can terminate on the IPv6 controller. You can provision an IPv6 AP in the network only if the controller interface is configured with an IPv6 address. An IPv6 AP can serve both IPv4 and IPv6 clients.



NOTE: You must manually configure an IPv6 address on the controller interface to enable IPv6 support.

You can perform the following IPv6 operations on the controller:

- ["Configuring IPv6 Addresses" on page 131](#)
- ["Configuring IPv6 Static Neighbors" on page 132](#)
- ["Configuring IPv6 Default Gateway and Static IPv6 Routes" on page 133](#)
- ["Managing Controller IP Addresses" on page 133](#)
- ["Configuring Multicast Listener Discovery \(MLD\)" on page 134](#)
- ["Debugging an IPv6 Controller" on page 135](#)
- ["Provisioning an IPv6 AP" on page 135](#)

You can also view the IPv6 statistics on the controller using the following commands:

- `show datapath ip-reassembly ipv6`: View the IPv6 contents of the IP Reassembly statistics table.
- `show datapath route ipv6`: View datapath IPv6 routing table.
- `show datapath route-cache ipv6`: View datapath IPv6 route cache.
- `show datapath tunnel ipv6`: View the tcp tunnel table filtered on IPv6 entries.
- `show datapath user ipv6`: View datapath IPv6 user statistics such as current entries, pending deletes, high water mark, maximum entries, total entries, allocation failures, invalid users, and maximum link length.
- `show datapath session ipv6`: View datapath IPv6 session entries and statistics such as current entries, pending deletes, high water mark, maximum entries, total entries, allocation failures, invalid users, and maximum link length.

Additionally, you can view the IPv6 AP information on the controller using the following show commands:

- `show ap database`
- `show ap active`
- `show user`
- `show ap details ip6-addr`
- `show ap debug`

The following table gives the list of features that are supported and not supported on IPv6 APs:

Table 37: IPv6 APs Support Matrix

Features	Supported on IPv6 APs?
Forward Mode - Tunnel	Yes
Forward Mode - Decrypt Tunnel	No
Forward Mode - Bridge	No
Forward Mode - Split Tunnel	No
AP Type - CAP	Yes
AP Type - RAP	No
AP Type - Mesh Node	No
IPSEC	No

Features	Supported on IPv6 APs?
CPSec	No
Wired-AP/Secure-Jack	No
Fragmentation/Reassembly	Yes
MTU Discovery	Yes
Provisioning through Static IPv6 Addresses	Yes
Provisioning through IPv6 FQDN Master Name	Yes
Provisioning from WebUI	Yes
AP boot by Flash	Yes
AP boot by TFTP	No
WMM QoS	No
AP Debug and Syslog	Yes
ARM & AM	Yes
WIDS	Yes (Limited)
CLI support for users & datapath	Yes

Configuring IPv6 Addresses

You can configure IPv6 addresses for the management interface, VLAN interface, and the loopback interface of the controller. The controller can have up to three IPv6 addresses for each VLAN interface. The IPv6 address configured on the loopback interface or the first VLAN interface of the controller becomes the default IPv6 address of the controller.



NOTE: If only one IPv6 address is configured on the controller, it becomes the default IPv6 address of the controller. With this release of ArubaOS, you can delete this IPv6 address.

You can configure IPv6 interface address using the WebUI or CLI.

In the WebUI

To Configure Link Local Address

1. Navigate to the **Configuration > Network > IP** page and select the **IP Interfaces** tab.
2. Edit a **VLAN #** and select **IP version** as IPv6.
3. Enter the link local address in the Link Local Address field.
4. Click the **Apply** button to apply the configuration.

To Configure Global Unicast Address

1. Navigate to the **Configuration > Network > IP** page and select the **IP Interfaces** tab.
2. Edit a **VLAN #** and select **IP version** as IPv6.
3. Enter the global unicast address and the prefix-length in the IP Address/Prefix-length field.

4. (Optional) Select the **EUI64 Format** check box, if applicable.
5. Click the **Add** button add the address to the global address list.
6. Click the **Apply** button to apply the configuration.

To Configure Loopback Interface Address

1. Navigate to the **Configuration > Network > Controller** page and select the **System Settings** tab.
2. Under **Loopback Interface** enter the loopback address in the **IPv6 Address** field.
3. Click the **Apply** button to apply the configuration.



NOTE: You cannot configure the management interface address using the WebUI.

In the CLI

To configure link local address

```
(host) (config) #interface vlan <vlan#>
(host) (config-subif) #ipv6 address <ipv6-address> link-local
```

To configure global unicast address

```
(host) (config) #interface vlan <vlan#>
(host) (config-subif) #ipv6 address <ipv6-prefix>/<prefix-length>
```

To configure global unicast address (EUI 64 format)

```
(host) (config) #interface vlan <vlan#>
(host) (config-subif) #ipv6 address <ipv6-prefix/prefix-length> eui-64
```

To configure management interface address

```
(host) (config) #interface mgmt
(host) (config-subif) #ipv6 address <ipv6-prefix/prefix-length>
```

To configure loopback interface address

```
(host) (config) #interface loopback
(host) (config-subif) #ipv6 address <ipv6-prefix>
```

Configuring IPv6 Static Neighbors

You can configure a static neighbor on a VLAN interface either using the WebUI or the CLI.

In the WebUI

1. Navigate to the **Configuration > Network > IP** page and select the **IPv6 Neighbors** tab.
2. Click the **Add** button and enter the following details of the IPv6 neighbor:
 - IPv6 Address
 - Link-layer Addr
 - VLAN Interface
3. Click the **Done** button to apply the configuration.

In the CLI

To configure a static neighbor on a VLAN interface

```
(host) (config) #ipv6 neighbor <ipv6addr> vlan <vlan#> <mac>
```

Configuring IPv6 Default Gateway and Static IPv6 Routes

You can configure IPv6 default gateway and static IPv6 routes using the WebUI or CLI.

In the WebUI

To Configure IPv6 Default Gateway

1. Navigate to the **Configuration > Network > IP** page and select the **IP Routes** tab.
2. Under the **Default Gateway** section, click the **Add** button.
3. Select IPv6 as **IP Version**, and enter the IPv6 address in the **IP Address** field.
4. Click the **Add** button to add the address to the IPv6 default gateway table.
5. Click the **Apply** button to apply the configuration.

To Configure Static IPv6 Routes

1. Under the **IP Routes** section, click the **Add** button and select IPv6 as **IP Version**.
2. Enter the destination IP address and the forwarding settings in the respective fields.
3. Click the **Done** button to add the static route to the IPv6 routes table.
4. Click the **Apply** button to apply the configuration.

In the CLI

To configure IPv6 default gateway

```
(host) (config) #ipv6 default-gateway <ipv6-address> <cost>
```

To configure static IPv6 routes

```
(host) (config) #ipv6 route <ipv6-prefix/prefix-length> <ipv6-next-hop> <cost>  
<ipv6-next-hop> = X:X:X:X::X
```

Managing Controller IP Addresses

You can change the default controller IP address by assigning a different VLAN interface address or the loop back interface address. You can also turn on Syslog messaging for IPv6 (similar to IPv4 logging) using the `logging <ipv6 address>` command. For more information on logging, see ["Configuring Logging" on page 640](#). You can use the WebUI or CLI to change the default controller IP address.

In the WebUI

1. Navigate to the **Configuration > Network > Controller** page and select the **System Settings** tab.
2. Under the **Controller IP Details** section, select the VLAN Id or the loopback interface Id in the **IPv6 Address** drop down.
3. Click the **Apply** button to apply the configuration.

In the CLI

To configure an IPv6 address to the controller

```
(host) (config) #controller-ipv6 loopback  
(host) (config) #controller-ipv6 vlan <vlanId>
```

To enable logging over IPv6

```
(host) (config) #logging <ipv6 address>
```

Configuring Multicast Listener Discovery (MLD)

You can enable the IPv6 multicast snooping on the controller using the WebUI or CLI. You can also modify the default values of the MLD parameters such as query interval, query response interval, and robustness variable.

In the WebUI

To Enable IPv6 MLD Snooping

1. Navigate to the **Configuration > Network > IP** page and select the **IP Interfaces** tab.
2. Edit the required VLAN interface.
3. Check the **Enable MLD Snooping** check box to enable IPv6 MLD snooping.
4. Click the **Apply** button to apply the configuration.

To Modify IPv6 MLD Parameters

1. Navigate to the **Configuration > Network > IP** page and select the **Multicast Routing** tab.
2. Under the **MLD** section, enter the required values in the following fields:
 - **Robustness Variable**: default value is 2
 - **Query Interval**: default value is 125 seconds
 - **Query Response Interval**: default value is 100 (1/10 seconds).
3. Click the **Apply** button to apply the configuration.

In the CLI

To enable IPv6 MLD snooping:

```
(host) (config) #interface vlan 1
(host) (config-subif) #ipv6 mld snooping
```

To view if IPv6 MLD snooping is enabled:

```
(host) (config-subif) #show ipv6 mld interface
MLD Interface Table
-----
VLAN  Snooping  Querier
----  -
1     enabled   ::
3     disabled  ::
60    disabled  ::
```

To modify IPv6 MLD parameters:

```
(host) (config) #ipv6 mld
(host) (config-mld) # query-interval <time in seconds (1-65535)>|query-response-interval
<time in 1/10th of seconds (1-65535)|robustness-variable <value (2-10)>
```

To view MLD configuration:

```
(host) (config-subif) #show ipv6 mld config
MLD Config
-----
Name                               Value
----                               -
robustness-variable                2
query-interval                     125
query-response-interval             100
```

Debugging an IPv6 Controller

You can now use the debug options such as ping and tracepath for IPv6 hosts. You can either use the WebUI or the CLI to use the ping and tracepath options.

In the WebUI

1. To ping an IPv6 host, navigate to the **Diagnostics > Network > Ping** page, enter an IPv6 address, and click the **Ping** button.
2. To trace the path of an IPv6 host, navigate to the **Diagnostics > Network > Tracepath** page, enter an IPv6 address, and click the **Trace** button.

In the CLI

To ping an IPv6 host

```
(host) #ping ipv6 <global-ipv6-address>
(host) #ping ipv6 interface vlan <vlan-id> <linklocal-address>
```

To trace the path of an IPv6 host

```
(host) #tracepath <global-ipv6-address>
```

Provisioning an IPv6 AP

You can provision an IPv6 AP on an IPv6 controller. You can either configure a static IP address or obtain a dynamic IPv6 address via stateless-autoconfig. The controller can act as the default gateway for the IPv6 clients, if static IPv6 routes are set on the controller.



NOTE: In this release of ArubaOS, the IPv6 controller cannot generate router advertisements (RA). It can, however, pass on the RAs generated by the external routers to the clients.

You can provision an IPv6 AP using the WebUI or CLI.

In the WebUI

1. Navigate to the **Configuration > AP Installation > Provision** page and select the **Provisioning** tab.
2. Select an AP and click the **Provision** button.
3. Under the **Master Discovery** section, enter the host controller IP address and the IPv6 address of the master controller.
4. To provision a static IP, select the **Use the following IP address** check box under the **IP Settings** section, and enter the following details:
 - IPv6 Address/Prefix-lengths
 - Gateway IPv6 Address
 - DNS IPv6 Address



NOTE: Ensure that CPSEC is disabled before rebooting the AP.

5. Click the **Apply and Reboot** button to bring the IPv6 AP up.

In the CLI

To provision a static IPv6 address

```
(host) (config)# provision-ap
(host) (AP provisioning)# master <IPv6 address of the master controller>
(host) (AP provisioning)# dns-server-ip6 <IPv6 address of the AP's DNS server>
(host) (AP provisioning)# ip6addr <the static IPv6 address of the AP>
(host) (AP provisioning)# ip6prefix <the prefix of the AP's static IPv6 address>
(host) (AP provisioning)# gateway6 <the default gateway IPv6 address for the AP>
```

Filtering an IPv6 Extension Header (EH)

ArubaOS firewall is enhanced to process the IPv6 Extension Header (EH) to enable IPv6 packet filtering. You can now filter the incoming IPv6 packets based on the EH type. You can edit the packet filter options in the default EH, using the CLI. By default, the default EH alias permits all EH types.

Execute the following commands to permit or deny the IPv6 packets matching an EH type:

```
(host) (config) #netexthdr default
(host) (config-exthdr) #eh <eh-type> permit | deny
```

To view the EH types denied:

```
(host) (config-exthdr) #show netexthdr default
```

```
Extended Header type(s) Denied
-----
51, 234,
```

Configuring a Captive Portal over IPv6

IPv6 is now enabled on the captive portal for user authentication on the Dell controller. For user authentication use the internal captive portal that is initiated from the controller. A new parameter `captive` has been added to the IPv6 captive portal session ACL.

```
ipv6 user alias controller6 svc-https captive
```



NOTE: This release does not support external captive portal for IPv6. The captive portal authentication, customization of pages, and other attributes are same as IPv4.

You can configure captive portal over IPv6 (similar to IPv4) using the WebUI or CLI. For more information on configuration, see ["Configuring Captive Portal in the Base Operating System" on page 234](#).

Working with IPv6 Router Advertisements (RAs)

ArubaOS enables the Dell controllers to send router advertisements (RA) in an IPv6 network. When a host connects to an IPv6 network, it configures itself with a link local address. The link local address allows the host to communicate between the nodes attached to the same link.

The IPv6 stateless autoconfiguration mechanism allows the host to generate its own addresses using a combination of locally available information and information advertised by the routers. The host sends a router solicitation multicast request for its configuration parameters in the IPv6 network. The source address of the Router Solicitation request can be an IP address assigned to the sending interface, or an unspecified address if no address is assigned to the sending interface.

The routers in the network respond with periodic unsolicited RA packets. The RA contains the network part of the Layer 3 IPv6 address (IPv6 Prefix). The host uses the IPv6 prefix provided by the RA; generates the universally unique host part of the address (interface identifier), and combines the two to derive the complete address. To

establish continuous connectivity to the default router, the host starts the neighbor reachability state machine for the router.



NOTE: ArubaOS uses Radvd, an open source Linux IPv6 Router Advertisement daemon maintained by Litech Systems Design.

You can perform the following tasks on the controller to enable, configure, and view the IPv6 RA status on a VLAN interface:

- Configure IPv6 RA on a VLAN
- Configure Optional Parameters for RA
 - Configure neighbor discovery reachable time
 - Configure neighbor discovery retransmit time
 - Configure RA DNS
 - Configure RA hop-limit
 - Configure RA interval
 - Configure RA lifetime
 - Configure RA managed configuration flag
 - Configure RA MTU
 - Configure RA other configuration flag
 - Configure RA Preference
 - Configure RA prefix
- View IPv6 RA Status

Configuring an IPv6 RA on a VLAN

You must configure the IPv6 RA functionality on a VLAN for it to send solicited/unsolicited router advertisements on the IPv6 network. You must do the following configurations for IPv6 RA to be operational on a VLAN:

- Configure IPv6 global unicast address
- Enable IPv6 RA
- Configure IPv6 RA prefix



NOTE: ● The advertised IPv6 prefix length must be 64 bits for the stateless address autoconfiguration to be operational.

- You can configure up to three IPv6 prefixes per VLAN interface.
 - Each IPv6 prefix must have an on-link interface address configured on the VLAN.
 - Ensure that the upstream routers are configured to route the packets back to Dell controller.
-

You can use the WebUI or CLI to configure IPv6 RA on a VLAN.

Using WebUI

1. Navigate to the **Configuration > Network > IP** page and select the **IP Interfaces** tab.
2. Edit a **VLAN #** and select **IP version** as *IPv6*.
3. To configure an IPv6 global unicast address, follow the steps below:
 - a. Under **Details**, enter the IPv6 address and the prefix-length in the **IP Address/Prefix-length** field.
 - b. (Optional) Select the **EUI64 Format** check box, if applicable.
 - c. Click **Add** to add the address to the global address list.

4. To enable IPv6 RA on a VLAN, select the **Enable Router Advertisements (RA)** check box under **Neighbor Discovery**.
5. To configure IPv6 RA prefix for a VLAN, follow the steps below:
 - a. Under **Neighbor Discovery**, enter an IPv6 prefix in the **IPv6 RA Prefix** field.
 - b. Click **Add** to configure an IPv6 prefix for the VLAN.
You can add up to three IPv6 prefixes per VLAN interface.
6. Click **Apply** to apply the configurations.

Using CLI

Execute the following commands to configure router advertisements on a VLAN:

```
(host) (config) #interface vlan <vlanid>
(host) (config-subif) #ipv6 address <prefix>/<prefix-length>
(host) (config-subif) #ipv6 nd ra enable
(host) (config-subif) #ipv6 nd ra prefix X:X:X:X::X/64
```

Configuring Optional Parameters for RAs

In addition to enabling the RA functionality, you can configure the following IPv6 neighbor discovery and RA options on a VLAN:

- Neighbor discovery reachable time: The time, in milliseconds, that a node assumes a neighbor is reachable after receiving a reachability confirmation.
- Neighbor discovery retransmit time: The time, in milliseconds, between retransmitted Neighbor Solicitation messages.
- RA DNS: The IPv6 recursive DNS Server for the VLAN.



NOTE: • On Linux systems, the clients must run the open rdnssd daemon to support the DNS server option.

- Windows 7 does not support DNS server option.
-

- RA hop-limit: The IPv6 RA hop-limit value. It is the default value to be placed in the Hop Count field of the IP header for outgoing (unicast) IP packets.
- RA interval: The maximum and minimum time interval between sending unsolicited multicast router advertisements from the interface, in seconds.
- RA lifetime: The lifetime associated with the default router in seconds. A value of 0 indicates that the router is not a default router and will not appear on the default router list. The router lifetime applies only to the router's usefulness as a default router; it does not apply to information contained in other message fields or options.
- RA managed configuration flag (Enable DHCP for address): A flag that indicates that the hosts can use the DHCP server for address autoconfiguration besides using RAs.
- RA maximum transmission unit (MTU): The maximum transmission unit that all the nodes on a link use.
- RA other configuration flag (Enable DHCP for other information): A flag that indicates that the hosts can use the administered (stateful) protocol for autoconfiguration of other (non-address) information.
- RA preference: The preference associated with the default router.

You can use the WebUI or CLI to configure these options.



NOTE: It is always recommended to retain the default value of the RA interval to achieve better performance.



NOTE: If you enable RAs on more than 100 VLAN interfaces, some of the interfaces may not send out the RAs at regular intervals.

In the WebUI

1. Navigate to the **Configuration>Network>IP** page.
2. Select the **IP Interfaces** tab.
3. Edit the VLAN on which you want to configure the neighbor discovery or RA options.
4. Select **IP Version** as *IPv6*.
5. Under **Neighbor Discovery**, configure the following neighbor discovery and RA options for the VLAN based on your requirements.
 - a. Enter a value in the **Reachable Time** field. The allowed range is 0 - 3,600,000 msec. The default value is 0.
 - b. Enter a value in the **Retransmit Time** field. The allowed range is 0 - 3,600,000 msec. The default value is 0.
 - c. Enter a DNS server name in the **IPv6 Recursive DNS Server** field.
 - d. Enter a hop-limit value in the **RA hop-limit** field. The allowed range is 1 to 255. The default value is 64.
 - e. Enter the maximum interval value in the **RA Interval(sec)** field. Allowed range is 4 to 1800 seconds. Default value is 600 seconds.
 - f. Enter a value in the **RA Minimum Interval(sec)** field. Allowed range is 3 to 0.75 times the maximum RA interval value in seconds. The default minimum value is 0.33 times the maximum RA interval value.
 - g. Enter a value in the **RA Lifetime** field. A value of 0 indicates that the router is not a default router. Apart from a zero value, the allowed range for the lifetime value is RA interval time to 9000 seconds. The default and minimum value is 3 times the RA interval time.
 - h. Select the **DHCP for address** check box to enable the hosts to use the DHCP server for address autoconfiguration apart from any addresses auto-configured using RA.
 - i. Enter a value in the **RA MTU Option** option. The allowed range is 1280 to maximum MTU allowed for the link.
 - j. Select the **DHCP for Other Address** check box to enable the hosts to use the DHCP server for autoconfiguration of other (non-address) information.
 - k. Select the router preference as **High, Medium, or Low**.
6. Click **Apply** to apply the configurations.

In the CLI

Execute the following CLI commands to configure the neighbor discovery and RA options for a VLAN interface:

To configure neighbor discovery reachable time:

```
(host) (config) #interface vlan <vlan-id>
(host) (config-subif)#ipv6 nd reachable-time <value>
```

To configure neighbor discovery retransmit time:

```
(host) (config-subif)#ipv6 nd retransmit-time <value>
```

To configure IPv6 recursive DNS server:

```
(host) (config-subif)#ipv6 nd ra dns X:X:X:X::X
```

To configure RA hop-limit:

```
(host) (config-subif)#ipv6 nd ra hop-limit <value>
```

To configure RA interval:

```
(host) (config-subif)#ipv6 nd ra interval <value> <min-value>
```

To configure RA lifetime:

```
(host) (config-subif)#ipv6 nd ra life-time <value>
```

To enable hosts to use DHCP server for stateful address autoconfiguration:

```
(host) (config-subif)#ipv6 nd ra managed-config-flag
```

To configure maximum transmission unit for RA:

```
(host) (config-subif)#ipv6 nd ra mtu <value>
```

To enable hosts to use DHCP server for other non-address stateful autoconfiguration:

```
(host) (config-subif)#ipv6 nd ra other-config-flag
```

To specify a router preference:

```
(host) (config-subif)#ipv6 nd ra preference [High | Low | Medium]
```

Viewing IPv6 RA Status

You can execute the following command to view the IPv6 RA status on the VLAN interfaces:

```
(host) #show ipv6 ra status
IPv6 RA Status
-----
VlanId  State      Prefix(es)
-----  -
1        enabled   2001:abcd:1234:dead::/64
220     enabled   2200:eab:feed:12::/64
230     enabled   2300:eab:feed::/64
7        enabled   2001:470:faca:2::/64
                2001:470:faca:3::/64
                2001:470:faca:4::/64
```

Understanding ArubaOS Supported Network Configuration for IPv6 Clients

ArubaOS provides wired or wireless clients using IPv6 addressing with services such as firewall functionality, layer-2 authentication, and, with the installation of the Policy Enforcement Firewall Next Generation (PEFNG), identity-based security. The Dell controller does not provide routing or Network Address Translation to IPv6 clients (see “Important Points to Remember” on page 140).

Supported Network Configuration

Clients can be wired or wireless and use IPv4 and/or IPv6 addressing. ArubaOS requires that the default gateway for the IPv6 clients be an external router that supports IPv6. The Dell controller itself has an IPv4 address, and can offer limited routing services to IPv6 clients. It is highly recommended to use an external IPv6 router for a complete routing experience (dynamic routing and router advertisements). You can use the WebUI or CLI to display IPv6 client information.

IPv6 clients must be mapped to a VLAN that is bridged to an external router which provides IPv6 services to those clients. On the controller, you can configure IPv4 and IPv6 clients on the same VLAN.



NOTE: IPv6 clients and the IPv6 router must be on the same VLAN.

Understanding the Network Connection Sequence for Windows IPv6 Clients

This section describes the network connection sequence for Windows Vista/XP clients that use IPv6 addresses, and the actions performed by the AP and controller.

1. The IPv6 client sends a Router Solicit message through the AP. The AP passes the Router Solicit message from the IPv6 client through the GRE tunnel to the controller.
2. The controller removes the 802.11 frame and creates an 802.3 frame for the Router Solicit message.
 - a. The controller authenticates the user, applies firewall policies and bridges the 802.3 frame to the IPv6 router.
 - b. Entries are created in the user and session tables.
3. IPv6 router responds with a Router Advertisement message.
4. The controller applies firewall policies, then creates an 802.11 frame for the Router Advertisement message. The controller sends the Router Advertisement through the GRE tunnel to the AP.
5. IPv6 client sends a Neighbor Solicitation message.
6. IPv6 router responds with a Neighbor Advertisement message.
7. If DHCP is required to provide IPv6 addresses, the DHCPv6 process is started.
8. IPv6 client sends data.
9. The controller removes the 802.11 frame and creates an 802.3 frame for the data.

The controller authenticates the user, applies firewall policies and bridges the 802.3 frame to the IPv6 router. Entries are created in the user and session tables.

Understanding ArubaOS Authentication and Firewall Features that Support IPv6

This section describes ArubaOS features that support IPv6 clients.

Understanding Authentication

This release of ArubaOS only supports 802.1x authentication for IPv6 clients. You cannot configure layer-3 authentications to authenticate IPv6 clients.

Table 38: *IPv6 Client Authentication*

Authentication Method	Supported for IPv6 Clients?
802.1x	Yes
Stateful 802.1x (with non-Dell APs)	Yes
Local database	Yes
Captive Portal	Yes
VPN	No
xSec	No (not tested)
MAC-based	Yes

You configure 802.1x authentication for IPv6 clients in the same way as for IPv4 client configuration. For more information about configuring 802.1x authentication on the controller, see [802.1X Authentication on page 192](#).



NOTE: This release does not support authentication of management users on IPv6 clients.

Working with Firewall Features

If you installed a Policy Enforcement Firewall Next Generation (PEFNG) license in the controller, you can configure firewall functions for IPv6 client traffic. While these firewall functions are identical to firewall functions for IPv4 clients, you need to explicitly configure them for IPv6 traffic. For more information about firewall policies, see “Global Firewall Parameters” on page 317.



NOTE: Voice-related and NAT firewall functions are not supported for IPv6 traffic.

Table 39: IPv6 Firewall Parameters

Authentication Method	Description
Monitor Ping Attack	Number of ICMP pings per second, which if exceeded, can indicate a denial of service attack. Valid range is 1–255 pings per second. Recommended value is 4. Default: No default
Monitor TCP SYN Attack rate	Number of TCP SYN messages per second, which if exceeded, can indicate a denial of service attack. Valid range is 1–255 messages per second. Recommended value is 32. Default: No default
Monitor IP Session Attack	Number of TCP or UDP connection requests per second, which if exceeded, can indicate a denial of service attack. Valid range is 1–255 requests per second. Recommended value is 32. Default: No default
Deny Inter User Bridging	Prevents the forwarding of Layer-2 traffic between wired or wireless users. You can configure user role policies that prevent Layer-3 traffic between users or networks but this does not block Layer-2 traffic. This option can be used to prevent traffic, such as Appletalk or IPX, from being forwarded. Default: Disabled
Deny All IP Fragments	Drops all IP fragments. NOTE: Do not enable this option unless instructed to do so by a Dell representative. Default: Disabled
Enforce TCP Handshake Before Allowing Data	Prevents data from passing between two clients until the three-way TCP handshake has been performed. This option should be disabled when you have mobile clients on the network as enabling this option will cause mobility to fail. You can enable this option if there are no mobile clients on the network. Default: Disabled
Prohibit IP Spoofing	Enables detection of IP spoofing (where an intruder sends messages using the IP address of a trusted client). When this option is enabled, IP and MAC addresses are checked for each ARP request/response. Traffic from a second MAC address using a specific IP address is denied, and the entry is not added to the user table. Possible IP spoofing attacks are logged and an SNMP trap is sent. Default: Disabled
Prohibit RST Replay	When enabled, closes a TCP connection in both directions if a TCP RST is received from either

Authentication Method	Description
Attack	direction. You should not enable this option unless instructed to do so by a Dell representative. Default: Disabled
Session Mirror Destination	Destination (IPv4 address or controller port) to which mirrored session packets are sent. You can configure IPv6 flows to be mirrored with the session ACL “mirror” option. This option is used only for troubleshooting or debugging. Default: N/A
Session Idle Timeout	Set the time, in seconds, that a non-TCP session can be idle before it is removed from the session table. Specify a value in the range 16–259 seconds. You should not set this option unless instructed to do so by a Dell representative. Default: 30 seconds
Per-packet Logging	Enables logging of every packet if logging is enabled for the corresponding session rule. Normally, one event is logged per session. If you enable this option, each packet in the session is logged. You should not enable this option unless instructed to do so by a Dell representative, as doing so may create unnecessary overhead on the controller. Default: Disabled (per-session logging is performed)
Ipv6 Enable	

The following examples configure attack rates and the session timeout for IPv6 traffic.

To configure the firewall function via the WebUI:

1. Navigate to the **Configuration > Advanced Services > Stateful Firewall > Global Setting** page.
2. Under the IPv6 column, enter the following:
 - For Monitor Ping Attack, enter 15
 - For Monitor IP Session Attack, enter 25
 - For Session Idle Timeout, enter 60
3. Click **Apply**.

To configure firewall functions using the command line interface, issue the following commands in config mode:

```
ipv6 firewall attack-rate ping 15
ipv6 firewall attack-rate session 25
ipv6 firewall session-idle-timeout 60
```

Understanding Firewall Policies

A user role, which determines a client’s network privileges, is defined by one or more firewall policies. A firewall policy consists of one or more rules that define the source, destination, and service type for specific traffic and whether you want the controller to permit or deny traffic that matches the rule.

You can configure firewall policies for IPv4 traffic or for IPv6 traffic and apply IPv4 and IPv6 firewall policies to the same user role. For example, if you have employees that are using both IPv4 and IPv6 clients you can configure both IPv4 and IPv6 firewall policies and apply them both to the “employee” user role.

The procedure to configure an IPv6 firewall policy rule is similar to configuring a firewall policy rule for IPv4 traffic, but with some differences. [Table 18](#) describes required and optional parameters for an IPv6 firewall policy rule.

Table 40: IPv6 Firewall Policy Rule Parameters

Field	Description
Source (required)	<p>Source of the traffic, which can be one of the following:</p> <ul style="list-style-type: none"> ● any: Acts as a wildcard and applies to any source address. ● user: This refers to traffic from the wireless client. ● host: This refers to traffic from a specific host. When this option is chosen, you must configure the IPv6 address of the host. For example, 2002:d81f:f9f0:1000:c7e:5d61:585c:3ab. ● network: This refers to a traffic that has a source IP from a subnet of IP addresses. When this option is chosen, you must configure the IPv6 address and network mask of the subnet. For example, 2002:ac10:fe::ffff:ffff::. ● alias: This refers to using an alias for a host or network. <p>NOTE: This release does not support IPv6 aliases. You cannot configure an alias for an IPv6 host or network.</p>
Destination (required)	Destination of the traffic, which can be configured in the same manner as Source.
Service (required)	<p>NOTE: Voice over IP services are not available for IPv6 policies.</p> <p>Type of traffic, which can be one of the following:</p> <ul style="list-style-type: none"> ● any: This option specifies that this rule applies to any type of traffic. ● tcp: Using this option, you configure a range of TCP port(s) to match for the rule to be applied. ● udp: Using this option, you configure a range of UDP port(s) to match for the rule to be applied. ● service: Using this option, you use one of the pre-defined services (common protocols such as HTTPS, HTTP, and others) as the protocol to match for the rule to be applied. You can also specify a network service that you configure by navigating to the Configuration > Advanced Services > Stateful Firewall > Network Services page. ● protocol: Using this option, you specify a different layer 4 protocol (other than TCP/UDP) by configuring the IP protocol value.
Action (required)	<p>The action that you want the controller to perform on a packet that matches the specified criteria. This can be one of the following:</p> <p>NOTE: The only actions for IPv6 policy rules are permit or deny; in this release, the controller cannot perform network address translation (NAT) or redirection on IPv6 packets. You can specify options such as logging, mirroring, or blacklisting (described below).</p> <ul style="list-style-type: none"> ● permit: Permits traffic matching this rule. ● drop: Drops packets matching this rule without any notification.
Log (optional)	Logs a match to this rule. This is recommended when a rule indicates a security breach, such as a data packet on a policy that is meant only to be used for voice calls.
Mirror (optional)	Mirrors session packets to datapath or remote destination specified in the IPv6 firewall function (see "Session Mirror Destination" in Table 39). If the destination is an IP address, it must be an IPv4 IP address.
Queue (optional)	The queue in which a packet matching this rule should be placed. Select High for higher priority data, such as voice, and Low for lower priority traffic.
Time Range (optional)	Time range for which this rule is applicable. You configure time ranges in the Configuration > Security > Access Control > Time Ranges page.
Black List (optional)	Automatically blacklists a client that is the source or destination of traffic matching this rule. This option is recommended for rules that indicate a security breach where the blacklisting option can be used to prevent access to clients that are attempting to breach the security.
TOS (optional)	Value of type of service (TOS) bits to be marked in the IP header of a packet matching this rule when it leaves the controller.
802.1p Priority (optional)	Value of 802.1p priority bits to be marked in the frame of a packet matching this rule when it leaves the controller.

The following example creates a policy ‘ipv6-web-only’ that allows only web (HTTP and HTTPS) access for IPv6 clients and assigns the policy to the user role “web-guest”.



NOTE: The user role “web-guest” can include both IPv6 and IPv4 policies, although this example only shows configuration of an IPv6 policy.

Creating an IPv6 Firewall Policy

Following the procedure below to create an IPv6 firewall policy via the WebUI.

1. Navigate to the **Configuration > Security > Access Control > Policies** page.
2. Click **Add** to create a new policy.
3. Enter **ipv6-web-only** for the Policy Name.
4. To configure a firewall policy, select **Session** for Policy Type.
5. Click **Add** to add a rule that allows HTTP traffic.
 - a. Under **IP Version** column, select **IPv6**.
 - b. Under **Source**, select **network** from the drop-down list.
 - c. For **Host IP**, enter **2002:d81f:f9f0:1000::**.
 - d. For **Mask**, enter **64** as the prefix-length.
 - e. Under **Service**, select **service** from the drop-down list.
 - f. Select **svc-http** from the scrolling list.
 - g. Click **Add**.
6. Click **Add** to add a rule that allows HTTPS traffic.
 - a. Under **IP Version** column, select **IPv6**.
 - b. Under **Source**, select **network** from the drop-down list.
 - c. For **Host IP**, enter **2002:d81f:f9f0:1000::**.
 - d. For **Mask**, enter **64** as the prefix-length.
 - e. Under **Service**, select **service** from the drop-down list.
 - f. Select **svc-https** from the scrolling list.
 - g. Click **Add**.



NOTE: Rules can be reordered using the up and down arrow buttons provided for each rule.

7. Click **Apply** to apply the configuration. The policy is not created until the configuration is applied.

To create an IPv6 firewall policy using the command-line interface, issue the following commands in config mode:

```
ip access-list session ipv6-web-only
  ipv6 network 2002:d81f:f9f0:1000::/64 any svc-http permit
  ipv6 network 2002:d81f:f9f0:1000::/64 any svc-https permit
```

Assigning an IPv6 Policy to a User Role

To assign an IPv6 policy using the WebUI:

1. Navigate to the **Configuration > Security > Access Control > User Roles** page.
2. Click **Add** to create a new user role.
3. Enter **web-guest** for Role Name.

4. Under Firewall Policies, click **Add**. From Choose from Configured Policies, select the “ipv6-web-only” IPv6 session policy from the list.
5. Click **Done** to add the policy to the user role.
6. Click **Apply** to apply this configuration.

To assign an IPv6 policy to a user role via the command-line interface, issue the following command in config mode:

```
user-role web-guest
  access-list session ipv6-web-only position 1
```

Understanding DHCPv6 Passthrough/Relay

The controller forwards DHCPv6 requests from IPv6 clients to the external IPv6 router. On the external IPv6 router, you must configure the controller’s IP address as the DHCP relay. You do *not* need to configure an IP helper address on the controller to forward DHCPv6 requests.

Managing IPv6 User Addresses

Viewing or Deleting User Entries

To view or delete IPv6 user entries via the WebUI:

1. Navigate to the **Monitoring > Controller > Clients** page.
2. Click the **IPv6** tab to display IPv6 clients.
3. To delete an entry in the IPv6 client display, click the radio button to the left of the client and then click **Disconnect**.

To view user entries for IPv6 clients using the command line interface, use the **show user-table** command in enable mode. To delete a user entry for an IPv6 client, access the CLI in config mode and use the **aaa ipv6 user delete** command. For example:

```
aaa ipv6 user delete 2002:d81f:f9f0:1000:e409:9331:1d27:ef44
```

Understanding User Roles

An IPv6 user or a client can inherit the corresponding IPv4 roles. A user or client entry on the user table will contain the user or client’s IPv4 and IPv6 entries. After captive-portal authentication, a IPv4 client can acquire a different role. This role is also updated on the client’s IPv6 entry in the user table.

Viewing Datapath Statistics for IPv6 Sessions

To view datapath session statistics for individual IPv6 sessions, access the command-line interface in enable mode and issue the command **show datapath session ipv6**. To display the user entries in the datapath, access the command-line interface in enable mode, and issue the command **show datapath user ipv6**. For details on each of these commands and the output they display, refer to the *ArubaOS Command Line Reference Guide*.

Understanding IPv6 Exceptions and Best Practices

This release of ArubaOS does not support the following functions for IPv6 clients:

- The controller offers limited routing services to IPv6 clients. It is highly recommended to use an external IPv6 router for a complete routing experience (dynamic routing).
- The controller does not perform network address translation on IPv6 addresses.
- Voice over IP is not supported for IPv6 clients.

- Remote AP supports IPv6 clients in tunnel forwarding mode only. The Remote AP bridge and split-tunnel forwarding modes do not support IPv6 clients. Secure Thin Remote Access Point (STRAP) cannot support IPv6 clients.
- The controller cannot terminate VPNs for IPv6 clients.
- VPN authentication cannot be performed for IPv6 clients.
- ArubaOS does not support RADIUS over IPv6 as an authentication protocol.
- Authentication of management users on IPv6 clients is not supported.
- A client can have an both IPv4 address and an IPv6 address, but the controller does not relate the states of the IPv4 and IPv6 addresses on the same client. For example, if an IPv6 user session is active on a client, an IPv4 user session on the same client will be deleted if the idle timeout for the IPv4 session is reached.

IPv6 best practices:

- IPv6 should be globally enabled.
(host) (config) #ipv6 enable
- Uplink port must be trusted. This is the same behavior as IPv4.
- Ensure `validuser` session ACL does not block IPv6 traffic.
- There must not be any ACLs that drop ICMPv6 or DHCPv6 traffic. It is acceptable to drop DHCPv6 traffic if the deployment uses StateLess Address Auto Configuration (SLAAC) only.
- If controller provides Router Advertisements (RA):
 - IPv6 VLAN interface address must be configured which maps to the prefixes configured.
 - 3 prefixes limit is enforced.
 - Controller does not support off-link prefixes.
- If controller does not provide RA:
 - It is not recommended to advertise too many prefixes in RA.
 - Controller limits four IPv6 address per user including link-local address (`fe80::/64`). When a large number of prefixes are configured on the upstream router, the client can use an IPv6 address that is beyond the allowed limit of number of IPv6 address per user.

Link Aggregation Control Protocol (LACP)

Dell's implementation of Link Aggregation Control Protocol (LACP) is based on the standards specified in 802.3ad. LACP provides a standardized means for exchanging information, with partner systems, to form a link aggregation group (LAG). LACP avoids port channel misconfiguration.

Two devices (actor and partner) exchange LACP data units (DUs) in the process of forming a LAG. Once multiple ports in the system have the same actor system ID, actor key, partner system ID, and partner key, they belong to the same LAG.

The maximum number of supported port-channels is 8. With the introduction of LACP, this number remains the same. In essence, a port-channel group (LAG) is created either statically or dynamically via LACP. This chapter contains:

- ["Understanding LACP Best Practices and Exceptions" on page 148](#)
- ["Configuring LACP" on page 149](#)
- ["LACP Sample Configuration" on page 150](#)

Understanding LACP Best Practices and Exceptions

- LACP is disabled by default
- LACP depends on periodical Tx/Rx of LACP data units (LACPDU). Any failures are noticed immediately and that port is removed from the LAG
- The maximum LAG supported per system is 8 groups; each group can be created statically or via LACP
- Each LAG can have up to 8 member ports
- The LAG group identification (ID) range is 0 to 7 for both static (port-channel) and LACP groups
- When a port is added to a LACP LAG, it inherits the port-channel's properties (i.e. VLAN membership, trunk status etc)
- When a port is added to LACP LAG, the port's property (i.e. speed) is compared to the existing port properties. If there is a mismatch, the command is rejected.
- The LACP commands can not be configured on a port that is already a member of a static port-channel. Similarly, if the group assigned in the command `lACP group <number>` already contains static port members, the command is rejected.
- The port uses the group number as it's actor admin key.
- By default, all ports use long timeout values (90 seconds).
- The output of the command `show interface port-channel` now indicates if the LAG is created by LACP (dynamic) or static configuration. If the LAG is created via LACP, you can not add/delete any ports under that port channel. All other commands are allowed.

Configuring LACP

Two LACP configured devices exchange LACPDU's to form a LAG. A device is configurable as an active or passive participant. In active mode, the device initiates DUs irrespective of the partner state; passive mode devices respond only to the incoming DUs sent by the partner device. Hence, to form a LAG group between two devices, one device must be an active participant. For detailed information on the LACP commands, see the ArubaOS Command Line Reference Guide.

In the CLI

LACPDUs exchange their corresponding system identifier/priority along with their port's key/priority. This information determines the LAG of a given port. The LAG for a port is selected based on its keys; the port is placed in that LAG only when its system ID/key and partner's system ID/key matches the other ports in the LAG (if the group has ports).

1. Enable LACP and configure the per-port specific LACP. The group number range is 0 to 7.

```
lacp group <group_number> mode {active | passive}
```

- Active mode—the interface is in active negotiating state. LACP runs on any link that is configured to be in the active state. The port in an active mode also automatically initiates negotiations with other ports by initiating LACP packets.
- Passive mode—the interface is *not* in an active negotiating state. LACP runs on any link that is configured in a passive state. The port in a passive mode responds to negotiations requests from other ports that are in an active state. Ports in passive state respond to LACP packets.



NOTE: A port in a passive state cannot set up a port channel (LAG group) with another port in a passive state.

2. Set the timeout for the LACP session. The timeout value is the amount of time that a port-channel interface waits for a LACPDU from the remote system before terminating the LACP session. The default time out value is long (90 seconds); short is 3 seconds.

```
lacp timeout {long | short}
```

3. Set the port priority.

```
lacp port-priority <priority_value>
```

The higher the priority value the lower the priority. Range is 1 to 65535 and default is 255.

4. View your LACP configuration.

The port uses the group number +1 as the “actor admin key”. By default, all the ports use the long timeout value (90 seconds).

```
(host)#show lacp 0 neighbor
Flags:  S - Device is requesting Slow LACPDUs
        F - Device is requesting fast LACPDUs
        A - Device is in active mode P - Device is in passive mode
```

Partner's information

```
-----
Port    Flags  Pri  OperKey  State Num  Dev Id
----    -
FE 1/1  SA     1     0x10    0x45  0x5   00:0b:86:51:1e:70
FE 1/2  SA     1     0x10    0x45  0x6   00:0b:86:51:1e:70
```

When a port in a LAG, is misconfigured (that is, the partner device is different than the other ports) or the neighbor timesout or can not exchange LACPDUs with the partner, the port status is displayed as “DOWN” (see the following example).

```
(host)#show lacp 0 internal
```

Flags: S - Device is requesting Slow LACPDUs

F - Device is requesting fast LACPDUs

A - Device is in active mode P - Device is in passive mode

Port	Flags	Pri	AdminKey	OperKey	State	Num	Status
FE 1/1	SA	1	0x1	0x1	0x45	0x2	DOWN
FE 1/2	SA	1	0x1	0x1	0x45	0x3	UP

In the WebUI

Access LACP from the **Configuration->Network->Port** tabs. Use the drop down menus to enter the LACP values.

Network > Port

Port Port-Channel

Port Selection

0 2 4 6 8 10 12 14 16 18 20 22

1 3 5 7 9 11 13 15 17 19 21 23 24 25

Configure Selected Port 1/0

Enable Port

Enable 802.3af Power Over Ethernet

Make Port Trusted

Port Mode Access Trunk

VLAN ID 62

Enter VLAN(s)

VLAN Firewall Policy in

LACP

2 Group

active Mode

526 Priority

long Timeout

Apply

Commands Hide Commands

```
interface fastethernet 1/0
 lACP group 2 mode active
 lACP port-priority 526
 lACP timeout long
!
```

- LACP Group—The link aggregation group (LAG) number; range is 0 to 7
- Mode—Active negotiation state or not in an active negotiation state indicated by the *passive* option.
- Priority—The port priority value; range is 1 to 65535 Default 255
- Timeout—Time out value for the LACP session; Long, the default, is 90 seconds; short is 3 seconds

LACP Sample Configuration

The following sample configuration is for FastEthernet (FE) port/slot 1/0, 1/1, and 1/2

```
interface fastethernet 1/0
  description "FE1/0"
  trusted vlan 1-4094
  lACP group 0 mode active
!
interface fastethernet 1/1
  description "FE1/1"
  trusted vlan 1-4094
  lACP timeout short
```

```
        lacp group 0 mode active
!
interface fastethernet 1/2
    description "FE1/2"
    trusted vlan 1-4094
    lacp group 0 mode passive
!
```

Chapter 10

OSPFv2

OSPFv2 (Open Shortest Path First) is a dynamic Interior Gateway routing Protocol (IGP) based on IETF RFC 2328. The premise of OSPF is that the shortest or fastest routing path is used. Dell's implementation of OSPFv2 allows Dell controllers to deploy effectively in a Layer 3 topology. Dell controllers can act as default gateway for all clients and forward user packets to the upstream router. The information in this chapter is in the following sections:

- ["Understanding OSPF Deployment Best Practices and Exceptions" on page 152](#)
- ["Understanding OSPFv2 by Example using a WLAN Scenario" on page 153](#)
- ["Understanding OSPFv2 by Example using a Branch Office Scenario" on page 154](#)
- ["Configuring OSPF " on page 155](#)
- ["Sample Topology and Configuration" on page 157](#)

Understanding OSPF Deployment Best Practices and Exceptions

OSPF is a robust routing protocol addressing various link types and deployment scenarios, the Dell implementation applies to two main use cases; WLAN Scenario and Branch Office Scenario.

- OSPF is disabled by default.
- Dell controllers support only one OSPF instance.
- Maximum OSPF routes is 1K.
- Convergence takes between 5 and 15 seconds.
- All area types are supported.
- Multiple configured areas are supported.
- A Dell controller can act as ABR (Area border router).
- OSPF supports VLAN and GRE tunnel interfaces.
- To run OSPF over IPsec tunnels, a Layer 3 GRE tunnel is configured between two routers with GRE destination addresses as the inner address of the IPsec tunnel. OSPF is enabled on the Layer 3 GRE tunnel interface and all of the OSPF control packets undergo GRE encapsulation before entering the IPsec tunnels.

The default MTU value for a Layer 3 GRE tunnel in a Dell controller is 1100. When running OSPF over a GRE tunnel between a Dell controller and another vendor's router, the MTU values must be the same on both sides of the GRE tunnel.

Below are some guidelines regarding deployment and topology for this release of OSPFv2.

- In WLAN scenario, configure the Dell controller and all upstream routers in totally stub area; in Branch Office scenario, configure as stub area so that the Branch Office controller can receive corporate subnets.
- In the WLAN scenario upstream router, only configure the interface connected to the controller in the same area as the controller. This will minimize the number of local subnet addresses advertised by the upstream router to the controller.
- Use the upstream router as the designated router (DR) for the link/interface between the controller and the upstream router.

- The default MTU value for a Layer 3 GRE tunnel in a Dell controller is 1100. When running OSPF over a GRE tunnel between a Dell controller and another vendor's router, the MTU values must be the same on both sides of the GRE tunnel.
- Do not enable OSPF on any uplink/WAN interfaces on the Branch Office Controller. Enable OSPF only on the Layer 3 GRE tunnel connecting the master controller.
- Use only one physical port in the uplink VLAN interface that is connecting to the upstream router. This will prevent broadcasting the protocol PDUs to other ports and hence limit the number of adjacencies on the uplink interface to only one.

Understanding OSPFv2 by Example using a WLAN Scenario

In the WLAN scenario, the Dell controller acts as a default gateway for all the clients and talks to one or two (for redundancy) upstream routers. The controller advertises all the user subnet addresses as stub addresses via LSAs to the routers..



NOTE: Totally stub areas *see* only a default route and routes local to the areas themselves.

WLAN Topology

The controller () is configured with VLAN 10 and VLAN 12 as user VLANs. These VLANs have clients on the subnets and the controller is the default router for those clients. VLAN 4 and VLAN 5 both have OSPF enabled. These interfaces are connected to a upstream routers (Router 1 and Router 2). The OSPF interface cost on VLAN 4 is configured lower than VLAN 5. The IDs are:

- Dell controller—40.1.1.1
- Router 1—50.1.1.1
- Router 2—60.1.1.1

Based on the cost of the uplink interface, default route from one of the upstream routers is installed in the forwarding information base (FIB) by the routing information base/route table manager (RIB/RTM) module.

WLAN Routing Table

View the controller routing table using the **show ip route** command:

```
(host) #show ip route

Codes: C - connected, O - OSPF, R - RIP, S - static
       M - mgmt, U - route usable, * - candidate default

Gateway of last resort is 4.1.1.2 to network 0.0.0.0

O*    0.0.0.0/0 [1/0] via 4.1.1.2*
C     4.1.1.0 is directly connected, VLAN4
C     5.1.1.0 is directly connected, VLAN5
C    10.1.1.0 is directly connected, VLAN10
C    12.1.1.0 is directly connected, VLAN12
```

Below is the routing table for Router 1:

```
(router1) #show ip route

Codes: C - connected, O - OSPF, R - RIP, S - static
       M - mgmt, U - route usable, * - candidate default
```

```

O    10.1.1.0/24 [1/0] via 4.1.1.1
O    12.1.1.0/24 [1/0] via 4.1.1.1
C    4.1.1.0 is directly connected, VLAN4

```

Below is the routing table for Router 2:

```

(router2) #show ip route

Codes: C - connected, O - OSPF, R - RIP, S - static
       M - mgmt, U - route usable, * - candidate default

O    10.1.1.0/24 [2/0] via 5.1.1.1
O    12.1.1.0/24 [2/0] via 5.1.1.1
C    5.1.1.0 is directly connected, VLAN5

```

Understanding OSPFv2 by Example using a Branch Office Scenario

The branch office scenario has a number of remote branch offices with Dell controllers talking to a central office via concentrator/controller using site-to-site VPN tunnels or master-local IPsec tunnels. The central office controller is in turn talking to upstream routers (see [Figure 41](#)). In this scenario the default route is normally pointed to the uplink router; in many cases the ISP. Configure the area as stub so that inter-area routes are also advertised enabling the branch office controller to reach the corporate subnets.

Branch Office Topology

All the OSPF control packets exchanged between the Branch office and the Central office Dell controllers undergo GRE encapsulation before entering the IPsec tunnels. The Dell controllers in the branch offices advertise all the user subnet addresses to the Central office controller as stub addresses in router LSA. The Central office controller in turn forwards those router LSAs to the upstream routers.

Figure 41: Branch Office OSPF Topology

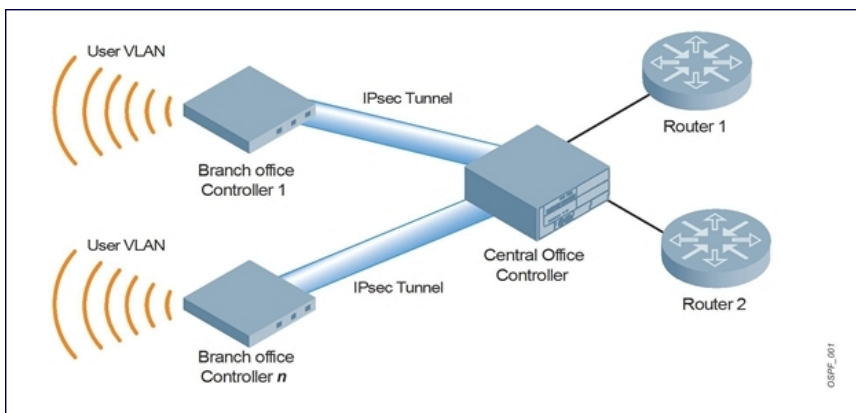

All the branch office Dell controllers, the Central office controller, and the upstream routers are part of a stub area. Since the OSPF packets follow GRE encapsulation over IPsec tunnels, the Central office controller can be a controller or any vendor's VPN concentrator. Regardless, the controller in the branch office will interoperate with other vendors seamlessly.

In [Figure 41](#), the branch office controller is configured using VLAN 14 and VLAN 15. Layer 3 GRE tunnel is configured with IP address 20.1.1.1/24 and OSPF is enabled on the tunnel interface.

In the Central office controller, OSPF is enabled on VLAN interfaces 4, 5, and, the Layer 3 GRE tunnel interface (configured with IP address 20.1.1.2/24). OSPF interface cost on VLAN 4 is configured lower than VLAN 5.

Branch Office Routing Table

View the branch office controller routing table using the **show ip route** command:

```
(host) #show ip route

Codes: C - connected, O - OSPF, R - RIP, S - static
       M - mgmt, U - route usable, * - candidate default

Gateway of last resort is 20.1.1.2 to network 0.0.0.0

O*    30.0.0.0/0 [1/0] via 20.1.1.2*
C     14.1.1.0 is directly connected, VLAN14
C     15.1.1.0 is directly connected, VLAN15
C     20.1.1.0 is directly connected, Tunnel 1
```

The routing table of the Central office controller is below:

```
(host) #show ip route

Codes: C - connected, O - OSPF, R - RIP, S - static
       M - mgmt, U - route usable, * - candidate default

Gateway of last resort is 4.1.1.2 to network 0.0.0.0

O*    0.0.0.0/0 [1/0] via 4.1.1.2*
O     14.1.1.0/24 [1/0] via 30.1.1.1*
O     15.1.1.0/24 [1/0] via 30.1.1.1*
C     4.1.1.0 is directly connected, VLAN4
C     5.1.1.0 is directly connected, VLAN5
C     20.1.1.0 is directly connected, Tunnel 1
```

The routing table for Router 1 is below:

```
(router1) #show ip route

Codes: C - connected, O - OSPF, R - RIP, S - static
       M - mgmt, U - route usable, * - candidate default

O     14.1.1.0/24 [1/0] via 4.1.1.1
O     15.1.1.0/24 [1/0] via 4.1.1.1
C     4.1.1.0 is directly connected, VLAN4
```

The routing table Router 2 is below:

```
(router2) #show ip route

Codes: C - connected, O - OSPF, R - RIP, S - static
       M - mgmt, U - route usable, * - candidate default

O     14.1.1.0/24 [1/0] via 5.1.1.1
O     15.1.1.0/24 [1/0] via 5.1.1.1
C     5.1.1.0 is directly connected, VLAN5
```

Configuring OSPF

Configure general OSPF settings from the OSPF tab on the Configuration > IP page (see [Figure 42](#)). The Area and Excluded subnets are displayed in table format. If not explicitly specified for OSPF, the router ID defaults to the switch IP.

Figure 42: General OSPF Configuration

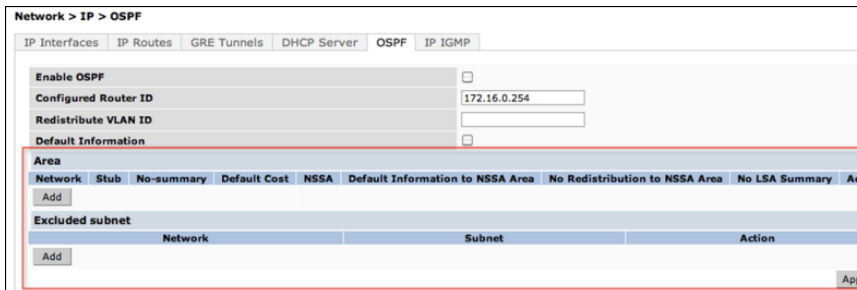

Select the Add button to add an area (see [Figure 43](#)).

Figure 43: Add an OSPF Area

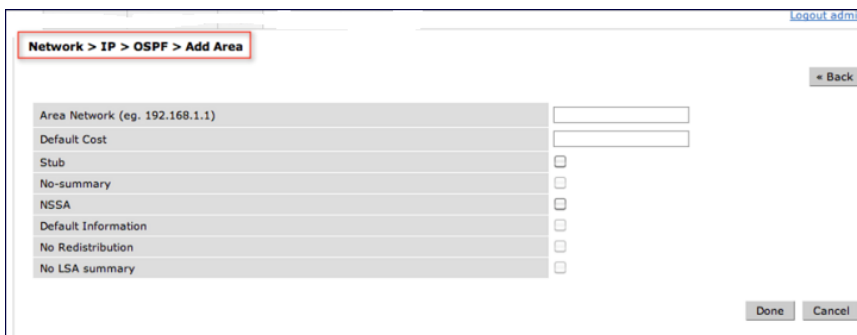

Configure the OSPF interface settings in the Configuration screen ([Figure 44](#)). If OSPF is enabled, the parameters contain the correct default values. The OSPF values are editable only when OSPF is enabled on the interface.

Figure 44: Edit OSPF VLAN Settings

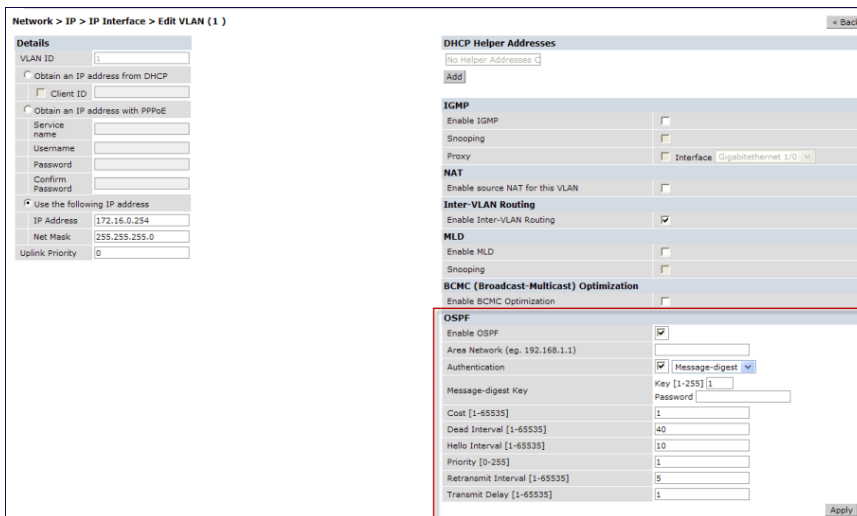

OSPF monitoring is available from an IP Routing sub-section (Controller > IP Routing > Routing). Both Static and OSPF routes are available in table format.

OSPF Interfaces and Neighboring information is available from the OSPF tab. The Interface information includes transmit (TX) and receive (RX) statistics.

Sample Topology and Configuration

displays a sample OSPF topology followed by sample configurations of the Remote Branch 1, Remote Branch 2, and the W-3200 Central Office Controller (Active and Backup).

Figure 45: Sample OSPF Topology

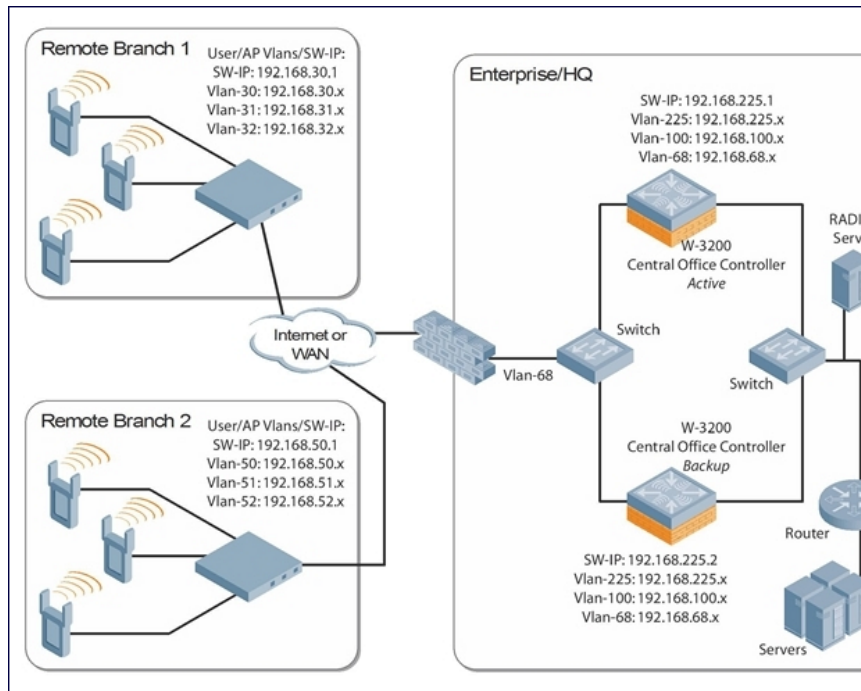

Remote Branch 1

```
controller-ip vlan 30
vlan 16
vlan 30
vlan 31
vlan 32
interface gigabitethernet 1/0
    description "GE1/0"
    trusted
    switchport access vlan 16
!
interface gigabitethernet 1/1
    description "GE1/1"
    trusted
    switchport access vlan 30
!
interface gigabitethernet 1/2
    description "GE1/2"
    trusted
    switchport access vlan 31
!
interface gigabitethernet 1/3
    description "GE1/3"
    trusted
    switchport access vlan 32
```

```

!
interface vlan 16
    ip address 192.168.16.251 255.255.255.0
!
interface vlan 30
    ip address 192.168.30.1 255.255.255.0
!
interface vlan 31
    ip address 192.168.31.1 255.255.255.0
!
interface vlan 32
    ip address 192.168.32.1 255.255.255.0
!
uplink wired priority 202
uplink cellular priority 201
uplink wired vlan 16
interface tunnel 2003
    description "Tunnel Interface"
    ip address 2.0.0.3 255.0.0.0
    tunnel source 192.168.30.1
    tunnel destination 192.168.68.217
    trusted
    ip ospf area 10.10.10.10
!
ip default-gateway 192.168.16.254
ip route 192.168.0.0 255.255.0.0 null 0
!
router ospf
router ospf router-id 192.168.30.1
router ospf area 10.10.10.10 stub
router ospf redistribute vlan 30-32

```

Remote Branch 2

```

controller-ip vlan 50
!
vlan 20
vlan 50
vlan 51
vlan 52
!
interface gigabitethernet 1/0
    description "GE1/0"
    trusted
    switchport access vlan 20
!
interface gigabitethernet 1/1
    description "GE1/1"
    trusted
    switchport access vlan 50
!
interface gigabitethernet 1/2
    description "GE1/2"
    trusted
    switchport access vlan 51
!
interface gigabitethernet 1/3
    description "GE1/3"
    trusted
    switchport access vlan 52
!

```

```

interface vlan 20
    ip address 192.168.20.1 255.255.255.0
!
interface vlan 50
    ip address 192.168.50.1 255.255.255.0
!
interface vlan 51
    ip address 192.168.51.1 255.255.255.0
!
interface vlan 52
    ip address 192.168.52.1 255.255.255.0
!
uplink wired priority 206
uplink cellular priority 205
uplink wired vlan 20
interface tunnel 2005
    description "Tunnel Interface"
    ip address 2.0.0.5 255.0.0.0
    tunnel source 192.168.50.1
    tunnel destination 192.168.68.217
    trusted
    ip ospf area 10.10.10.10
!
ip default-gateway 192.168.20.254
ip route 192.168.0.0 255.255.0.0 null 0
!
router ospf
router ospf router-id 192.168.50.1
router ospf area 10.10.10.10 stub
router ospf redistribute vlan 50-52

```

W-3200 Central Office Controller—Active

```

localip 0.0.0.0 ipsec db947e8d1b383813a4070ab0799fa6246b80fc5cfcc3268f
controller-ip vlan 225
vlan 68
vlan 100
vlan 225
!
interface gigabitethernet 1/0
    description "GE1/0"
    trusted
    switchport access vlan 225
!
interface gigabitethernet 1/1
    description "GE1/1"
    trusted
    switchport access vlan 100
!
interface gigabitethernet 1/2
    description "GE1/2"
    trusted
    switchport access vlan 68
!
interface vlan 68
    ip address 192.168.68.220 255.255.255.0
!
interface vlan 100
    ip address 192.168.100.1 255.255.255.0
!
interface vlan 225

```

```

        ip address 192.168.225.2 255.255.255.0
    !
interface tunnel 2003
    description "Tunnel Interface"
    ip address 2.1.0.3 255.0.0.0
    tunnel source 192.168.225.2
    tunnel destination 192.168.30.1
    trusted
    ip ospf area 10.10.10.10
!
interface tunnel 2005
    description "Tunnel Interface"
    ip address 2.1.0.5 255.0.0.0
    tunnel source 192.168.225.2
    tunnel destination 192.168.50.1
    trusted
    ip ospf area 10.10.10.10
!
master-redundancy
    master-rrrp 2
    peer-ip-address 192.168.68.221 ipsec password123
!
vrrp 1
    priority 120
    authentication password123
    ip address 192.168.68.217
    vlan 68
    preempt
    tracking vlan 68 sub 40
    tracking vlan 100 sub 40
    tracking vlan 225 sub 40
    no shutdown
!
vrrp 2
    priority 120
    ip address 192.168.225.9
    vlan 225
    preempt
    tracking vlan 68 sub 40
    tracking vlan 100 sub 40
    tracking vlan 225 sub 40
    no shutdown
!
ip default-gateway 192.168.68.1
ip route 192.168.0.0 255.255.0.0 null 0

router ospf
router ospf router-id 192.168.225.1
router ospf area 10.10.10.10 stub
router ospf redistribute vlan 100,225
!

```

W-3200 Central Office Controller—Backup

```

localip 0.0.0.0 ipsec db947e8d1b383813a4070ab0799fa6246b80fc5cfcc3268f
controller-ip vlan 225
!
interface gigabitethernet 1/0
    description "GE1/0"
    trusted
    switchport access vlan 225

```



```

!
interface gigabitethernet 1/1
    description "GE1/1"
    trusted
    switchport access vlan 100
!
interface gigabitethernet 1/2
    description "GE1/2"
    trusted
    switchport access vlan 68
!
interface vlan 68
    ip address 192.168.68.221 255.255.255.224
!
interface vlan 100
    ip address 192.168.100.5 255.255.255.0
!
interface vlan 225
    ip address 192.168.225.1 255.255.255.0
!
interface tunnel 2003
    description "Tunnel Interface"
    ip address 2.1.0.3 255.0.0.0
    tunnel source 192.168.225.1
    tunnel destination 192.168.30.1
    trusted
    ip ospf area 10.10.10.10
!
interface tunnel 2005
    description "Tunnel Interface"
    ip address 2.1.0.5 255.0.0.0
    tunnel source 192.168.225.1
    tunnel destination 192.168.50.1
    trusted
    ip ospf area 10.10.10.10
!
master-redundancy
    master-rrrp 2
    peer-ip-address 192.168.68.220 ipsec password123
!
vrrp 1
    priority 99
    authentication password123
    ip address 192.168.68.217
    vlan 68
    tracking vlan 68 sub 40
    tracking vlan 100 sub 40
    tracking vlan 225 sub 40
    no shutdown
!
vrrp 2
    priority 99
    ip address 192.168.225.9
    vlan 225
    tracking vlan 68 sub 40
    tracking vlan 100 sub 40
    tracking vlan 225 sub 40
    no shutdown
!
ip default-gateway 192.168.68.1
ip route 192.168.0.0 255.255.0.0 null 0

```

```
!  
router ospf  
router ospf router-id 192.168.225.1  
router ospf area 10.10.10.10 stub  
router ospf redistribute vlan 100,225  
!
```

Chapter 11

Tunneled Nodes

This chapter describes how to configure a Dell tunneled node, also known as a wired tunneled node. Dell tunneled nodes provide access and security using an overlay architecture.

This chapter describes the following topics:

- ["Understanding Tunneled Node Configuration" on page 163](#)
- ["Configuring a Wired Tunneled Node Client" on page 164](#)
- ["Sample Output" on page 166](#)

Understanding Tunneled Node Configuration

The Dell tunneled node connects to one or more client devices at the edge of the network and then establishes a secure GRE tunnel to the controlling concentrator server. This approach allows the controller to support all the centralized security features, such as 802.1x authentication, captive-portal authentication, and stateful firewall. The Dell tunneled node is required to handle only the physical connection to clients and support for its end of the GRE tunnel.

To support the wired concentrator, the controller must have a license to terminate access points (APs). No other configuration is required. To configure the Dell tunneled node, you must specify the IP address of the controller and identify the ports that are to be used as active tunneled node ports. Tunnels are established between the controller and each active tunneled node port on the tunneled node. All tunneled node units must be running the same version of software. The tunneled node port can also be configured as a trunk port. This allows customers to have multiple clients on different VLANs that come through the trunk port instead of having clients on a single vlan.

[Figure 46](#) shows how the tunneled node fits into network operations. Traffic moves through GRE tunnels between the active tunneled node ports and the controller or Dell controllers. Policies are configured on a master server and enforced on the local Dell controllers. The master and the controller can run on the same or different systems. The tunneled node can connect to the master, but it is not required.

On the controlling controller, you can assign the same policy to tunneled node user traffic as you would to any untrusted wired traffic. The profile specified by the `aaa authentication wired` command determines the initial role, which contains the policy. The VLAN setting on the concentrator port must match the VLAN that will be used for users at the local controller.

Figure 46: Tunneled node configuration operation

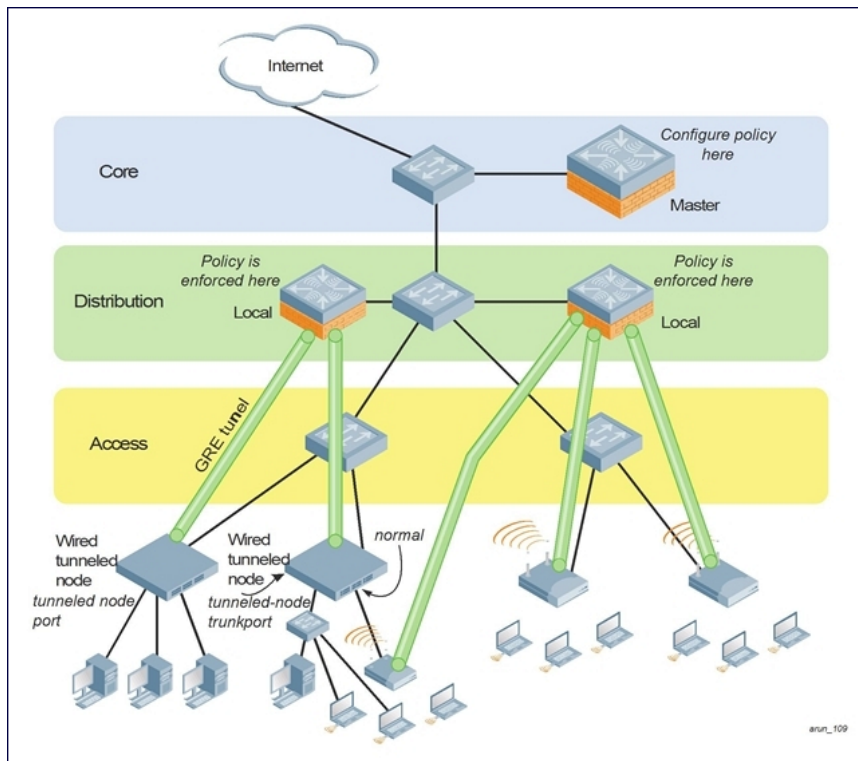

Configuring a Wired Tunneled Node Client

NOTE: ArubaOS does not allow a tunneled-node client and tunneled-node server to co-exist on the same controller at the same time. The controller must be configured as either a tunneled-node client or a tunneled-node server. By default, the Aruba controller behaves as a tunneled-node server. However, once tunneled-node-server xxx.xxx.xxx.xxx is configured on the controller, the controller becomes a tunneled-node client. To remove the tunneled-node client function, use the command `tunneled-node-server 0.0.0.0` to disable the tunneled-node client on the controller side.

This section describes how to configure a tunneled node client. You can use the WebUI or the CLI to complete the configuration steps.

1. Access the Wired tunneled node CLI according to the instructions provided in the installation guide that shipped with your tunneled node. Console access (9600 8N1) and SSH access are supported.
2. Specify the IP address of the controller and specify tunnel loop prevention.

- CLI:

```
(host) (config) #tunneled-node-address ipaddress
(host) (config) #tunnel-loop-prevention
```

For example:

```
(host (config) # tunneled-node-address 10.10.1.1
(host) (config) #tunnel-loop-prevention
```

- WebUI

- a. Navigate to **Configuration>Advanced Services>Wired Access** page.

- b. Locate the **Wired Access Concentration Configuration** section.
 - c. To enable tunneled nodes, click the **Enable Wired Access Concentrator** checkbox.
 - d. Enter the IP address of the controller in the **Wired Access Concentrator Server IP** field.
 - e. To enable tunnel loop prevention, click the **Enable Wired Access Concentrator Loop Prevention** checkbox.
 - f. Click **Apply**.
3. Access each interface that you want to use, and assign it as a tunneled node port.

```
(host) (config) # interface fastethernet n/m
(host) (config-if) # tunneled-node port
```

Example:

```
(host) (config) #interface fastethernet 2/1
(host) (config-if) # tunneled-node-port
(host) (config) #interface fastethernet 2/3
(host) (config-if) # tunneled-node-port
```

4. Verify the configuration.

```
(host) (config-if) # exit
(host) # show tunneled-port config
```

Example:

```
(host) #show tunneled-node config
Tunneled Node Client:Enabled
Tunneled Node Server:10.10.1.1
```

Configuring an Access Port as a Tunneled Node Port

You can configure any port on any controller as a tunneled node port using the `tunneled-node-port` command. Set the `tunneled-nod-address` as the controller to act as the tunneled node termination point. The `tunneled-node-port` command tells the physical interface to tunnel that traffic to the controller.

1. Enable portfast on the Wired tunneled node.

```
(host) (config) #interface fastethernet <slot>/<port>
(host) (config-if) # spanning-tree portfast
```

Example:

```
(host) (config) #interface fastethernet 2/1
(host) (config-if) # spanning-tree portfast
```

2. Assign a VLAN to the tunneled node port.

```
(host) (config-if) # switchport mode access
(host) (config-if) # switchport access vlan <vlanid>
```

Example:

```
(host) (config-if) # switchport access vlan 10
```

Configuring a Trunk Port as a Tunneled Node Port

1. Enable portfast on the Wired tunneled node.

```
(host) (config-if) # switchport mode trunk
(host) (config-if) # switchport trunk allowed vlan <WORD>
```

Example:

```
(host) (config-if) # switch trunk allowed vlan 3-5,8,9
```

Sample Output

Use the `show tunneled-node state` command to verify the status of the Wired tunneled node.

```
(show) # show tunneled-node state
```

```
Tunneled Node State
```

```
-----  
IP             MAC             s/p  state    vlan  tunnel  inactive-time  
--             ---             ---  -----  ----  -
```

IP	MAC	s/p	state	vlan	tunnel	inactive-time
192.168.123.14	00:0b:86:40:32:40	1/23	complete	10	9	1
192.168.123.14	00:0b:86:40:32:40	1/22	complete	10	10	1
192.168.123.14	00:0b:86:40:32:40	1/20	complete	10	11	1

On the tunneled node client:

```
(host) #show tunneled-node state
```

```
Tunneled Node State
```

```
-----  
IP             MAC             s/p  state    vlan  tunnel  inactive-time  
--             ---             ---  -----  ----  -
```

IP	MAC	s/p	state	vlan	tunnel	inactive-time
192.168.123.16	00:0b:86:40:32:40	1/23	complete	10	21	0
192.168.123.16	00:0b:86:40:32:40	1/22	complete	10	9	0
192.168.123.16	00:0b:86:40:32:40	1/20	complete	10	13	0

```
(host) #show tunneled-node config
```

```
Tunneled Node:Enabled  
Tunneled Node Server:200.1.1.1  
Tunnel Loop Prevention:Disabled
```

Use the `show license-usage ap` command to check current usage on the controller. Each tunneled node client uses one AP license. Attaching an additional wired client on the tunneled node client does not increment the AP license usage on the controller.

```
(host) #show license-usage ap
```

```
Total AP Licenses           : 128  
AP Licenses Used             : 1  
Tunneled Node Licenses Used           : 1  
Unused AP Licenses           : 127  
Licenses used for Campus AP's        : 1  
Available Campus AP's           : 31  
Licenses used for Remote AP's        : 0  
Available Remote AP's           : 127  
Total Ortronics AP Licenses         : 128  
Ortronics AP Licenses Used          : 0  
Total Indoor Mesh AP's Supported     : 128  
Indoor Mesh AP's Active             : 0  
Total Outdoor Mesh AP's supported    : 128  
Outdoor Mesh AP's Active            : 0  
Total RF Protect Licenses           : 128  
RF Protect Licenses Used            : 1  
Total PEF Licenses               : 128  
PEF Licenses Used                 : 1  
Total 802.11n-120abg Licenses       : 128  
802.11n-120abg Licenses Used        : 0  
Total 802.11n-121abg Licenses       : 128  
802.11n-121abg Licenses Used        : 0
```

```
Total 802.11n-124abg Licenses : 128
802.11n-124abg Licenses Used : 0
Total 802.11n-125abg Licenses : 128
802.11n-125abg Licenses Used : 0
```

Chapter 12

Authentication Servers

The ArubaOS software allows you to use an external authentication server or the controller internal user database to authenticate clients who need to access the wireless network.

This chapter describes the following topics:

- "Understanding Authentication Server Best Practices and Exceptions" on page 168
- "Understanding Servers and Server Groups" on page 168
- "Configuring Servers" on page 169
- "Managing the Internal Database" on page 175
- "Configuring Server Groups" on page 177
- "Assigning Server Groups" on page 184
- "Configuring Authentication Timers" on page 187

Understanding Authentication Server Best Practices and Exceptions

- In order for an external authentication server to process requests from the Dell controller, you must configure the server to recognize the controller. Refer to the vendor documentation for information on configuring the authentication server.
- Instructions on how to configure Microsoft's IAS and Active Directory can be viewed at:
Microsoft's IAS
<http://technet2.microsoft.com/windowsserver/en/technologies/ias.mspx>
Active Directory
<http://www.microsoft.com/en-us/server-cloud/windows-server/active-directory.aspx>

Understanding Servers and Server Groups

ArubaOS supports the following external authentication servers:

- RADIUS (Remote Authentication Dial-In User Service)
- (Lightweight Directory Access Protocol)
- TACACS+ (Terminal Access controller Access Control System)
- Windows (For stateful NTLM authentication)

Additionally, you can use the controller's internal database to authenticate users. You create entries in the database for users and their passwords and default role.

You can create *groups* of servers for specific types of authentication. For example, you can specify one or more RADIUS servers to be used for 802.1x authentication. The list of servers in a server group is an ordered list. This means that the first server in the list is always used unless it is unavailable, in which case the next server in the list is used. You can configure servers of different types in one group — for example, you can include the internal database as a backup to a RADIUS server.

Figure 47 graphically represents a server group named “Radii” that consists of two RADIUS servers, Radius-1 and Radius-2. The server group is assigned to the server group for 802.1x authentication.

Figure 47: Server Group

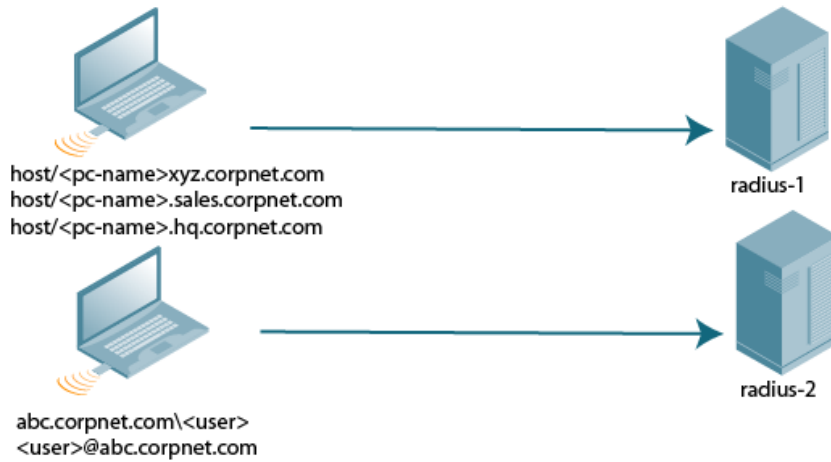

Server names are unique. You can configure the same server in multiple server groups. You must configure the server before you can add it to a server group.



NOTE: If you are using the controller’s internal database for user authentication, use the predefined “Internal” server group.

You can also include conditions for server-derived user roles or VLANs in the server group configuration. The server derivation rules apply to all servers in the group.

Configuring Servers

This section describes how to configure RADIUS, LDAP, TACACS+ and Windows external authentication servers and the internal database on the controller.

Configuring a RADIUS Server

Table 48 describes the parameters you configure for a RADIUS server.

Table 48: RADIUS Server Configuration Parameters

Parameter	Description
Host	IP address or fully qualified domain name (FQDN) of the authentication server. The maximum supported FQDN length is 63 characters. Default: N/A
Key	Shared secret between the controller and the authentication server. The maximum length is 128 characters. Default: N/A
Authentication Port	Authentication port on the server. Default: 1812

Parameter	Description
Accounting Port	Accounting port on the server Default: 1813
Retransmits	Maximum number of retries sent to the server by the controller before the server is marked as down. Default: 3
Timeout	Maximum time, in seconds, that the controller waits before timing out the request and resending it. Default: 5 seconds
NAS ID	Network Access Server (NAS) identifier to use in RADIUS packets. Default: N/A
NAS IP	NAS IP address to send in RADIUS packets. You can configure a "global" NAS IP address that the controller uses for communications with all RADIUS servers. If you do not configure a server-specific NAS IP, the global NAS IP is used. To set the global NAS IP in the WebUI, navigate to the Configuration > Security > Authentication > Advanced page. To set the global NAS IP in the CLI, enter the <code>ip radius nas-ipaddr</code> command. Default: N/A
Source Interface	Enter a VLAN number ID. Allows you to use source IP addresses to differentiate RADIUS requests. Associates a VLAN interface with the RADIUS server to allow the server-specific source interface to override the global configuration. <ul style="list-style-type: none"> • If you associate a Source Interface (by entering a VLAN number) with a configured server, then the source IP address of the packet is that interface's IP address. • If you do not associate the Source Interface with a configured server (leave the field blank), the IP address of the global Source Interface is used.
Use MD5	Use MD5 hash of cleartext password. Default: disabled
Mode	Enables or disables the server. Default: enabled

Using the WebUI

1. Navigate to the **Configuration > Security > Authentication > Servers** page.
2. Select **Radius Server** to display the Radius Server List.
3. To configure a RADIUS server, enter the name for the server and click **Add**.
4. Select the name to configure server parameters. Enter parameters as described in [Table 48](#). Select the **Mode** checkbox to activate the authentication server.
5. Click **Apply** to apply the configuration.



NOTE: The configuration does not take effect until you perform this step.

Using the CLI

```
(host) (config) #aaa authentication-server radius <name>
  host <ipaddr>
  key <key>
  enable
```

RADIUS Server Authentication Codes

A configured RADIUS server returns the following standard response codes.

Table 49: RADIUS Authentication Response Codes

Code	Description
0	Authentication OK.
1	Authentication failed—user/password combination not correct.
2	Authentication request timed out—No response from server.
3	Internal authentication error.
4	Bad Response from RADIUS server. Verify shared secret is correct.
5	No RADIUS authentication server is configured.
6	Challenge from server. (This does not necessarily indicate an error condition.)

RADIUS Server Fully Qualified Domain Names

If you define a RADIUS server using the FQDN of the server rather than its IP address, the controller periodically generates a DNS request and cache the IP address returned in the DNS response. To view the IP address that currently correlate to each RADIUS server FQDN, access the command-line interface in config mode and issue the following command:

```
show aaa fqdn-server-names
```

Set a DNS Query Interval

If you define a RADIUS server using the FQDN of the server rather than its IP address, the controller periodically generates a DNS request and cache the IP address returned in the DNS response. By default, DNS requests are sent every 15 minutes.

You can use either the WebUI or the CLI to configure how often the controller should generate a DNS request to cache the IP address for a RADIUS server identified via its fully qualified domain name (FQDN).

Using the WebUI

1. Navigate to the **Configuration > Security > Authentication > Advanced** page.
2. In the **DNS Query Interval (min)** field, enter a new DNS query interval, from 1-1440 minutes, inclusive.
3. Click **Apply** to save your changes.

Using the CLI

```
(host) (config) #aaa dns-query-period <minutes>
```

Configuring an RFC-3576 RADIUS Server

You can configure a RADIUS server to send user disconnect, change-of-authorization (CoA), and session timeout messages as described in RFC 3576, “Dynamic Authorization Extensions to Remote Dial In User Service (RADIUS)”.

The disconnect and change-of-authorization messages sent from the server to the controller contains information to identify the user for which the message is sent. The controller supports the following attributes for identifying the users who authenticate with a RFC 3576 server:

- user-name: Name of the user to be authenticated
- framed-ip-address: User's IP address
- calling-station-id: Phone number of a station that originated a call
- accounting-session-id: Unique accounting ID for the user session.

If the authentication server sends both supported and unsupported attributes to the controller, the unknown or unsupported attributes are ignored. If no matching user is found the controller sends a *503: Session Not Found* error message back to the RFC 3576 server.

Using the WebUI

1. Navigate to the **Configuration > Security > Authentication > Servers** page.
2. Select **RFC 3576 Server** to display the Radius Server List.
3. To define a new RFC 3576 RADIUS server, enter the IP address for the server and click **Add**.
4. Select the server name to configure server parameters.
5. Enter the server authentication key into the **Key** and **Retype** fields.
6. Click **Apply** to apply the configuration.



NOTE: The configuration does not take effect until you perform this step.

Using the CLI

```
(host) (config) #aaa rfc-3576-server <ipaddr>
  clone <server>
  key <psk>
  no ...
```

Configuring an LDAP Server

Table 50 describes the parameters you configure for an LDAP server.

Table 50: LDAP Server Configuration Parameters

Parameter	Description
Host	IP address of the LDAP server. Default: N/A
Admin-DN	Distinguished name for the admin user who has read/search privileges across all the entries in the LDAP database (the user does need write privileges but should be able to search the database, and read attributes of other users in the database).
Admin Password	Password for the admin user. Default: N/A
Allow Clear-Text	Allows clear-text (unencrypted) communication with the LDAP server. Default: disabled
Authentication Port	Port number used for authentication.

Parameter	Description
	Default: 389
Base-DN	Distinguished Name of the node that contains the entire user database. Default: N/A
Filter	A string that is used to search for users in the LDAP database. The default filter string is: (objectclass=*) . Default: N/A
Key Attribute	A string that is used to search for a LDAP server. For Active Directory, the value is sAMAccountName . Default: sAMAccountName
Timeout	Timeout period of a LDAP request, in seconds. Default: 20 seconds
Mode	Enables or disables the server. Default: enabled
Preferred Connection Type	Preferred type of connection between the controller and the LDAP server. The default order of connection type is: <ol style="list-style-type: none"> 1. ldap-s 2. start-tls 3. clear-text The controller first tries to contact the LDAP server using the preferred connection type, and only attempts to use a lower-priority connection type if the first attempt is not successful. NOTE: If you select clear-text as the preferred connection type, you must also enable the allow-cleartext option.

Using the WebUI

1. Navigate to the **Configuration > Security > Authentication > Servers** page.
2. Select **LDAP Server** to display the LDAP Server List.
3. To configure an LDAP server, enter the name for the server and click **Add**.
4. Select the name to configure server parameters. Enter parameters as described in [Table 50](#). Select the **Mode** checkbox to activate the authentication server.
5. Click **Apply** to apply the configuration.



NOTE: The configuration does not take effect until you perform this step.

Using the CLI

```
(host) (config) #aaa authentication-server ldap <name>
host <ipaddr>
(enter parameters as described in Table 50)
enable
```

Configuring a TACACS+ Server

[Table 51](#) defines the TACACS+ server parameters.

Table 51: TACACS+ Server Configuration Parameters

Parameter	Description
Host	IP address of the server. Default: N/A
Key	Shared secret to authenticate communication between the TACACS+ client and server. Default: N/A
TCP Port	TCP port used by server. Default: 49
Retransmits	Maximum number of times a request is retried. Default: 3
Timeout	Timeout period for TACACS+ requests, in seconds. Default: 20 seconds
Mode	Enables or disables the server. Default: enabled
Session Authorization	Enables or disables session authorization. Session authorization turns on the optional authorization session for admin users. Default: disabled

Using the WebUI

1. Navigate to the **Configuration > Security > Authentication > Servers** page.
2. Select **TACACS Server** to display the TACACS Server List.
3. To configure a TACACS+ server, enter the name for the server and click **Add**.
4. Select the name to configure server parameters. Enter parameters as described in [Table 51](#). Select the **Mode** checkbox to activate the authentication server.
5. Click **Apply** to apply the configuration.



NOTE: The configuration does not take effect until you perform this step.

Using the CLI

The following command configures, enables a TACACS+ server and enables session authorization:

```
(host) (config) #aaa authentication-server tacacs <name>
  clone default
  host <ipaddr>
  key <key>
  enable
  session-authorization
```

Configuring a Windows Server

[Table 52](#) defines parameters for a Windows server used for stateful NTLM authentication.

Table 52: Windows Server Configuration Parameters

Parameter	Description
Host	IP address of the server. Default: N/A
Mode	Enables or disables the server. Default: enabled
Windows Domain	Name of the Windows Domain assigned to the server.

Using the WebUI

1. Navigate to the **Configuration > Security > Authentication > Servers** page.
2. Select **Windows Server** to display the Windows Server List.
3. To configure a Windows server, enter the name for the server and click **Add**.
4. Select the name of the server to configure its parameters. Enter the parameters as described in [Table 52](#).
5. Select the **Mode** checkbox to activate the authentication server.
6. Click **Apply** to apply the configuration.



NOTE: The configuration does not take effect until you perform this step.

Using the CLI

```
aaa authentication-server windows <windows-server-name>  
  host <ipaddr>  
  enable
```

Managing the Internal Database

You can create entries in the controller's internal database, to use to authenticate clients. The internal database contains a list of clients along with the password and default role for each client. When you configure the internal database as an authentication server, client information in incoming authentication requests is checked against the internal database.

Configuring the Internal Database

By default, the internal database in the master controller is used for authentication. You can choose to use the internal database in a local controller by entering the CLI command **aaa authentication-server internal use-local-switch**. If you use the internal database in a local controller, you need to add clients on the local controller.

[Table 53](#) defines the required and optional parameters used in the internal database.

Table 53: Internal Database Configuration Parameters

Parameters	Description
User Name	(Required) Enter a user name or select Generate to automatically generate a user name. An entered username can be up to 64 characters in length.

Parameters	Description
Password	(Required) Enter a password or select Generate to automatically generate a password string. An entered password must be a minimum of 6 characters and can be up to 128 characters in length.
Role	Role for the client. In order for this role to be assigned to a client, you need to configure a server derivation rule, as described in "Configuring Server-Derivation Rules" on page 182 . (A user role assigned through a server-derivation rule takes precedence over the default role configured for an authentication method.)
E-mail	(Optional) E-mail address of the client.
Enabled	Select this checkbox to enable the user as soon as the user entry is created.
Expiration	Select one of the following options: <ul style="list-style-type: none"> ● Entry does not expire: No expiration on user entry ● Set Expiry time (mins): Enter the number of minutes the user is authenticated before their user entry expires. ● Set Expiry Date (mm/dd/yyyy) Expiry Time (hh:mm): To select a specific expiration date and time, enter the expiration date in mm/dd/yyyy format, and the expiration time in hh:mm format.
Static Inner IP Address (for RAPs only)	Assign a static inner IP address to a Remote AP. If this database entry is not for a remote AP, leave this field empty.

Using the WebUI

1. Navigate to the **Configuration > Security > Authentication > Servers** page.
2. Select **Internal DB**.
3. Click **Add User** in the **Users** section. The user configuration page displays.
4. Enter the information for the client, as described in the table above.
5. Click **Enabled** to activate this entry on creation.
6. Click **Apply** to apply the configuration. The configuration does not take effect until you perform this step.
7. At the Servers page, click **Apply**.



NOTE: The Internal DB Maintenance window also includes a **Guest User Page** feature that allows you to create user entries for guests only. For details on creating guest users, see ["Guest Provisioning User Tasks" on page 651](#).

Using the CLI

Enter the following command in enable mode:

```
(host) (config) #local-userdb add {generate-username|username <name>}{
generate-password|password <password>}
```

Managing Internal Database Files

ArubaOS allows you to import and export tables of user information to and from the internal database. These files should not be edited once they are exported. ArubaOS only supports the importing of database files that were created during the export process. Note that importing a file into the internal database overwrite and removes all existing entries.

Exporting Files in the WebUI

1. Navigate to the **Configuration > Security > Authentication > Servers** page.
2. Select **Internal DB**.

3. Click **Export** in the **Internal DB Maintenance** section. A popup window opens.
4. Enter the name of the file you want to export
5. Click **OK**.

Importing Files in the WebUI

1. Navigate to the **Configuration > Security > Authentication > Servers** page.
2. Select **Internal DB**.
3. Click **-** in the **Internal DB Maintenance** section. A popup window opens.
4. Enter the name of the file you want to import
5. Click **OK**.

Exporting and Importing Files in the CLI

Enter the following command in enable mode:

```
(host) (config) #local-userdb export <filename>
(host) (config) #local-userdb import <filename>
```

Working with Internal Database Utilities

The local internal database also includes utilities to clear all users from the database and to restart the internal database to repair internal errors. Under normal circumstances, neither of these utilities are necessary.

Deleting All Users

Issue this command to remove users from the internal database after you have moved your user database from the controller's internal server to an external server.

1. Navigate to the **Configuration > Security > Authentication > Servers** page.
2. Select **Internal DB**.
3. Click **Delete All Users** in the **Internal DB Maintenance** section. A popup window open and asks you to confirm that you want to remove all users.
4. Click **OK**.

Repairing the Internal Database

Use this utility under the supervision of Dell technical support to recreate the internal database. This may clear internal database errors, but also removes all information from the database. Make sure you export your current user information before you start the repair procedure.

1. Navigate to the **Configuration > Security > Authentication > Servers** page.
2. Select **Internal DB**.
3. Click **Repair Database** in the **Internal DB Maintenance** section. A popup window open and asks you to confirm that you want to recreate the database.
4. Click **OK**.

Configuring Server Groups

You can create *groups* of servers for specific types of authentication — for example, you can specify one or more RADIUS servers to be used for 802.1x authentication. You can configure servers of different types in one group — for example, you can include the internal database as a backup to a RADIUS server.

Configuring Server Groups

Server names are unique. You can configure the same server in more than one server group. The server must be configured before you can include it in a server group.

Using the WebUI

1. Navigate to the **Configuration > Security > Authentication > Servers** page.
2. Select **Server Group** to display the Server Group list.
3. Enter the name of the new server group and click **Add**.
4. Select the name to configure the server group.
5. Under Servers, click **New** to add a server to the group.
 - a. Select a server from the drop-down menu and click **Add Server**.
 - b. Repeat the above step to add other servers to the group.
6. Click **Apply**.

Using the CLI

```
(host) (config) #aaa server-group <name>
auth-server <name>
```

Configuring Server List Order and Fail-Through

The list of servers in a server group is an ordered list. By default, the first server in the list is always used unless it is unavailable, in which case the next server in the list is used. You can configure the order of servers in the server group. In the WebUI, use the up or down arrows to order the servers (the top server is the first server in the list). In the CLI, use the **position** parameter to specify the relative order of servers in the list (the lowest value denotes the first server in the list).

As mentioned previously, the first available server in the list is used for authentication. If the server responds with an authentication failure, there is no further processing for the user or client for which the authentication request failed. You can optionally enable *fail-through* authentication for the server group so that if the first server in the list returns an authentication deny, the controller attempts authentication with the next server in the ordered list. The controller attempts authentication with each server in the list until either there is a successful authentication or the list of servers in the group is exhausted. This feature is useful in environments where there are multiple, independent authentication servers; users may fail authentication on one server but can be authenticated on another server.

Before enabling fail-through authentication, note the following:

- This feature is not supported for 802.1x authentication with a server group that consists of external EAP-compliant RADIUS servers. You can, however, use fail-through authentication when the 802.1x authentication is terminated on the controller (AAA FastConnect).
- Enabling this feature for a large server group list may cause excess processing load on the controller. Dell recommends that you use server selection based on domain matching whenever possible (see "[Configuring Dynamic Server Selection](#)" on page 179).
- Certain servers, such as the RSA RADIUS server, lock out the controller if there are multiple authentication failures. Therefore you should not enable fail-through authentication with these servers.

In the following example, you create a server group 'corp-serv' with two LDAP servers (ldap-1 and ldap-2), each of which contains a subset of the usernames and passwords used in the network. When fail-through authentication is enabled, users that fail authentication on the first server in the server list should be authenticated with the second server.

Using the WebUI

1. Navigate to the **Configuration > Security > Authentication > Servers** page.
2. Select **LDAP Server** to display the LDAP Server List.
3. Enter ldap-1 for the server name and click **Add**.
4. Enter ldap-2 for the server name and click **Add**.
5. Under the Servers tab, select ldap-1 to configure server parameters. Enter the IP address for the server. Select the **Mode** checkbox to activate the authentication server. Click **Apply**.
6. Repeat [step 5 on page 179](#) to configure ldap-2.
7. Display the Server Group list: Under the Servers tab, select **Server Group**.
8. Enter **corp-serv** as the new server group and click **Add**.
9. Select **corp-serv**, under the Server tab, to configure the server group.
10. Select **Fail Through**.
11. Under Servers, click **New** to add a server to the group. Select ldap-1 from the drop-down menu and click **Add Server**.
12. Repeat [step 11 on page 179](#) to add ldap-2 to the group.
13. Click **Apply**.

Using the CLI

```
(host) (config) #aaa authentication-server ldap ldap-1
    host 10.1.1.234
(host) (config) #aaa authentication-server ldap ldap-2
    host 10.2.2.234

(host) (config) #aaa server-group corp-serv
    auth-server ldap-1 position 1
    auth-server ldap-2 position 2
    allow-fail-through
```

Configuring Dynamic Server Selection

The controller can dynamically select an authentication server from a server group based on the user information sent by the client in an authentication request. For example, an authentication request can include client or user information in one of the following formats:

- <domain>\<user> — for example, corpnet.com\darwin
- <user>@<domain> — for example, darwin@corpnet.com
- host/<pc-name>.<domain> — for example, host/darwin-g.finance.corpnet.com (this format is used with 802.1x machine authentication in Windows environments)

When you configure a server in a server group, you can optionally associate the server with one or more match rules. A match rule for a server can be one of the following:

- The server is selected if the client/user information *contains* a specified string.
- The server is selected if the client/user information *beginswith* a specified string.
- The server is selected if the client/user information *exactly* matches a specified string.

You can configure multiple match rules for the same server. The controller compares the client/user information with the match rules configured for each server, starting with the first server in the server group. If a match is found, the controller sends the authentication request to the server with the matching rule. If no match is found before the end of the server list is reached, an error is returned and no authentication request for the client/user is sent.

For example, [Figure 54](#) depicts a network consisting of several subdomains in corpnet.com. The server radius-1 provides 802.1x machine authentication to PC clients in xyz.corpnet.com, sales.corpnet.com, and hq.corpnet.com. The server radius-2 provides authentication for users in abc.corpnet.com.

Figure 54: Domain-Based Server Selection Example

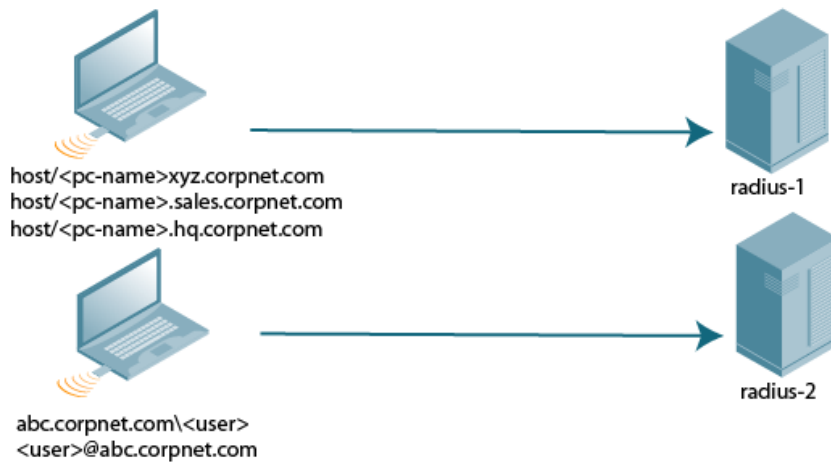

You configure the following rules for servers in the corp-serv server group:

- radius-1 is selected if the client information starts with “host/”.
- radius-2 is selected if the client information contains “abc.corpnet.com”.

Using the WebUI

1. Navigate to the **Configuration > Security > Authentication > Servers** page.
2. Under the Servers tab, select **Server Group** to display the Server Group list.
3. Enter **corp-serv** for the new server group and click **Add**.
4. Under the Servers tab, select **corp-serv** to configure the server group.
5. Under Servers, click **New** to add the radius-1 server to the group. Select radius-1 from the drop-down menu.
 - a. For Match Type, select **Authstring**.
 - b. For Operator, select **starts-with**.
 - c. For Match String, enter **host/**.
 - d. Click **Add Rule >>**.
 - e. Scroll to the right and click **Add Server**.
6. Under Servers, click **New** to add the radius-2 server to the group. Select radius-2 from the drop-down menu.
 - a. For Match Type, select **Authstring**.
 - b. For Operator, select **contains**.
 - c. For Match String, enter **abc.corpnet.com**.
 - d. Click **Add Rule >>**.
 - e. Scroll to the right and click **Add Server**.

NOTE: The last server you added to the server group (radius-2) automatically appears as the first server in the list. In this example, the order of servers is not important. If you need to reorder the server list, scroll to the right and click the up or down arrow for the appropriate server.

7. Click **Apply**.



Using the CLI

```
(host) (config) #aaa server-group corp-serv
  auth-server radius-1 match-authstring starts-with host/ position 1
  auth-server radius-2 match-authstring contains abc.corpnet.com position 2
```

Configuring Match FQDN Option

You can also use the “match FQDN” option for a server match rule. With a match FQDN rule, the server is selected if the <domain> portion of the user information in the formats <domain>\<user> or <user>@<domain> *exactly* matches a specified string. Note the following caveats when using a match FQDN rule:

- This rule does *not* support client information in the host/<pc-name>.<domain> format, so it is not useful for 802.1x machine authentication.
- The match FQDN option performs matches on only the <domain> portion of the user information sent in an authentication request. The match-authstring option (described previously) allows you to match all or a portion of the user information sent in an authentication request.

Using the WebUI

1. Navigate to the **Configuration > Security > Authentication > Servers** page
2. Under the Servers tab, select **Server Group** to display the Server Group list.
3. Enter **corp-serv** for the new server group and click **Add**.
4. Under the Servers tab, select **corp-serv** to configure the server group.
5. Under Servers, click **New** to add the radius-1 server to the group. Select radius-1 from the drop-down menu.
 - a. For Match Type, select **FQDN**.
 - b. For Match String, enter **corpnet.com**.
 - c. Click **Add Rule >>**.
 - d. Scroll to the right and click **Add Server**.
6. Click **Apply**.

Using the CLI

```
(host) (config) #aaa server-group corp-serv
  auth-server radius-1 match-fqdn corpnet.com
```

Trimming Domain Information from Requests

Before the controller forwards an authentication request to a specified server, it can truncate the domain-specific portion of the user information. This is useful when user entries on the authenticating server do not include domain information. You can specify this option with any server match rule. This option is only applicable when the user information is sent to the controller in the following formats:

- <domain>\<user> — the <domain>\ portion is truncated
- <user>@<domain> — the @<domain> portion is truncated



NOTE: This option does not support client information sent in the format host/<pc-name>.<domain>

Using the WebUI

1. Navigate to the **Configuration > Security > Authentication > Servers** page.
2. Select **Server Group** to display the Server Group list.
3. Enter the name of the new server group and click **Add**.

4. Select the name to configure the server group.
5. Under Servers, click **Edit** for a configured server or click **New** to add a server to the group.
 - If editing a configured server, select Trim FQDN, scroll right, and click **Update Server**.
 - If adding a new server, select a server from the drop-down menu, then select Trim FQDN, scroll right, and click **Add Server**.
6. Click **Apply**.

Using the CLI

```
(host) (config) #aaa server-group corp-serv
auth-server radius-2 match-authstring contains abc.corpnet.com trim-fqdn
```

Configuring Server-Derivation Rules

When you configure a server group, you can set the VLAN or role for clients based on attributes returned for the client by the server during authentication. The server derivation rules apply to all servers in the group. The user role or VLAN assigned through server derivation rules takes precedence over the default role and VLAN configured for the authentication method.



NOTE: The authentication servers must be configured to return the attributes for the clients during authentication. For instructions on configuring the authentication attributes in a Windows environment using IAS, refer to the documentation at <http://technet2.microsoft.com/windowsserver/en/technologies/ias.mspx>.

The server rules are applied based on the first match principle. The first rule that is applicable for the server and the attribute returned is applied to the client and would be the only rule applied from the server rules. These rules are applied uniformly across all servers in the server group.

Table 55 describes the server rule parameters you can configure.

Table 55: Server Rule Configuration Parameters

Parameter	Description
Role or VLAN	The server derivation rules can be for either user role or VLAN assignment. With Role assignment, a client can be assigned a specific role based on the attributes returned. In case of VLAN assignment, the client can be placed in a specific VLAN based on the attributes returned.
Attribute	This is the attribute returned by the authentication server that is examined for <i>Operation</i> and <i>Operand</i> match.
Operation	This is the match method by which the string in <i>Operand</i> is matched with the attribute value returned by the authentication server. <ul style="list-style-type: none"> • contains – The rule is applied if and only if the attribute value contains the string in parameter <i>Operand</i>. • starts-with – The rule is applied if and only if the attribute value returned starts with the string in parameter <i>Operand</i>. • ends-with – The rule is applied if and only if the attribute value returned ends with the string in parameter <i>Operand</i>. • equals – The rule is applied if and only if the attribute value returned equals the string in parameter <i>Operand</i>. • not-equals – The rule is applied if and only if the attribute value returned is not equal to the string in parameter <i>Operand</i>. • value-of – This is a special condition. What this implies is that the role or VLAN is set to the value of the attribute returned. For this to be successful, the role and the VLAN ID

Parameter	Description
	returned as the value of the attribute selected must be already configured on the controller when the rule is applied.
Operand	This is the string to which the value of the returned attribute is matched.
Value	The user role or the VLAN name applied to the client when the rule is matched.
position	Position of the condition rule. Rules are applied based on the first match principle. 1 is the top. Default: bottom

Using the WebUI

1. Navigate to the **Configuration > Security > Authentication > Servers** page.
2. Select **Server Group** to display the Server Group list.
3. Enter the name of the new server group and click **Add**.
4. Select the name to configure the server group.
5. Under Servers, click **New** to add a server to the group.
 - a. Select a server from the drop-down menu and click **Add**.
 - b. Repeat the above step to add other servers to the group.
6. Under Server Rules, click **New** to add server derivation rules for assigning a user role or VLAN.
 - a. Enter the attribute.
 - b. Select the operation from the drop-down menu.
 - c. Enter the operand.
 - d. To set the role, select **set role** from the **Set** drop-down menu and enter the value to be assigned from the **Value** drop-down menu.
 - e. Or, to set the vlan, select **set vlan** from the **Set** drop-down menu and select the VLAN name or ID from the **Value** drop-down menu and click the left-arrow.
 - f. Click **Add**.
 - g. Repeat the above steps to add other rules for the server group.
7. Click **Apply**.

Using the CLI

```
(host) (config) #aaa server-group name
      (host) (Server Group name) #set {role|vlan} condition condition contains operand set-value
      <
      set-value-str> position number
```

Configuring a Role Derivation Rule for the Internal Database

When you add a user entry in the controller's internal database, you can optionally specify a user role (see ["Managing the Internal Database" on page 175](#)). In order for the role specified in the internal database entry to be assigned to the authenticated client, you must configure a server derivation rule as shown in the following sections:

Using the WebUI

1. Navigate to the **Configuration > Security > Authentication > Servers** page.
2. Select **Server Group** to display the Server Group list.
3. Select the **internal** server group.

4. Under Server Rules, click **New** to add a server derivation rule.
 - a. For Condition, enter Role.
 - b. Select value-of from the drop-down menu.
 - c. Select Set Role from the drop-down menu.
 - d. Click **Add**.
5. Click **Apply**.

Using the CLI

```
(host) (config) #aaa server-group internal
  set role condition Role value-of
```

Assigning Server Groups

You can create server groups for the following purposes:

- user authentication
- management authentication
- accounting

You can configure all types of servers for user and management authentication (see [Table 56](#)). Accounting is only supported with RADIUS and TACACS+ servers when RADIUS or TACACS+ is used for authentication.

Table 56: *Server Types and Purposes*

	RADIUS	TACACS+	LDAP	Internal Database
User authentication	Yes	Yes	Yes	Yes
Management authentication	Yes	Yes	Yes	Yes
Accounting	Yes	Yes	No	No

User Authentication

For information about assigning a server group for user authentication, refer to the *Roles and Policies* chapter of the *Dell PowerConnect W-ArubaOS User Guide*.

Management Authentication

Users who need to access the controller to monitor, manage, or configure the Dell user-centric network can be authenticated with RADIUS, TACACS+, or LDAP servers or the internal database.



NOTE: Only user record attributes are returned upon a successful authentication. Therefore, to derive a different management role other than the default mgmt auth role, set the server derivation rule based on the user attributes.

Using the WebUI

1. Navigate to the **Configuration > Management > Administration** page.
2. Under the Management Authentication Servers section, select the Server Group.
3. Click **Apply**.

Using the CLI

```
(host) (config) #aaa authentication mgmt
```

server-group <group>

Accounting

You can configure accounting for RADIUS and TACACS+ server groups.



NOTE: RADIUS or TACACS+ accounting is only supported when RADIUS or TACACS+ is used for authentication.

RADIUS Accounting

RADIUS accounting allows user activity and statistics to be reported from the controller to RADIUS servers.

RADIUS accounting works as follows:

1. The controller generates an Accounting Start packet when a user logs in. The code field of transmitted RADIUS packet is set to 4 (Accounting-Request). Note that sensitive information, such as user passwords, are not sent to the accounting server. The RADIUS server sends an acknowledgement of the packet.
2. The controller sends an Accounting Stop packet when a user logs off; the packet information includes various statistics such as elapsed time, input and output bytes and packets. The RADIUS server sends an acknowledgement of the packet.

The following is the list of attributes that the controller can send to a RADIUS accounting server:

- **Acct-Status-Type:** This attribute marks the beginning or end of accounting record for a user. Currently, possible values include Start and Stop.
- **User-Name:** Name of user.
- **Acct-Session-Id:** A unique identifier to facilitate matching of accounting records for a user. It is derived from the user name, IP address and MAC address. This is set in all accounting packets.
- **Acct-Authentic:** This indicates how the user was authenticated. Current values are 1 (RADIUS), 2 (Local) and 3 (LDAP).
- **Acct-Session-Time:** The elapsed time, in seconds, that the client was logged in to the controller. This is only sent in Accounting-Request records where the Acct-Status-Type is Stop.
- **Acct-Terminate-Cause:** Indicates how the session was terminated and is sent in Accounting-Request records where the Acct-Status-Type is Stop. Possible values are:
 - 1: User logged off
 - 4: Idle Timeout
 - 5: Session Timeout. Maximum session length timer expired.
 - 7: Admin Reboot: Administrator is ending service, for example prior to rebooting the controller.
- **NAS-Identifier:** This is set in the RADIUS server configuration.
- **NAS-IP-Address:** IP address of the master controller. You can configure a “global” NAS IP address: in the WebUI, navigate to the **Configuration > Security > Authentication > Advanced** page; in the CLI, use the **ip radius nas-ip** command.
- **NAS-Port:** Physical or virtual port (tunnel) number through which the user traffic is entering the controller.
- **NAS-Port-Type:** Type of port used in the connection. This is set to one of the following:
 - 5: admin login
 - 15: wired user type
 - 19: wireless user
- **Framed-IP-Address:** IP address of the user.
- **Calling-Station-ID:** MAC address of the user.
- **Called-station-ID:** MAC address of the controller.

The following attributes are sent in Accounting-Request packets when Acct-Status-Type value is Start:

- Acct-Status-Type
- User-Name
- NAS-IP-Address
- NAS-Port
- NAS-Port-Type
- NAS-Identifier
- Framed-IP-Address
- Calling-Station-ID
- Called-station-ID
- Acct-Session-Id
- Acct-Authentic

The following attributes are sent in Accounting-Request packets when Acct-Status-Type value is Stop:

- Acct-Status-Type
- User-Name
- NAS-IP-Address
- NAS-Port
- NAS-Port-Type
- NAS-Identifier
- Framed-IP-Address
- Calling-Station-ID
- Called-station-ID
- Acct-Session-Id
- Acct-Authentic
- Terminate-Cause
- Acct-Session-Time

The following attributes are sent only in Accounting Stop packets (they are not sent in Accounting Start packets):

- Acct-Input-Octets
- Acct-Output-Octets
- Acct-Input-Packets
- Acct-Output-Packets

Remote APs in split-tunnel mode now support RADIUS accounting. If you enable RADIUS accounting in a split-tunnel Remote AP's AAA profile, the controller sends a RADIUS accounting start record to the RADIUS server when a user associates with the remote AP, and sends a stop record when the user logs out or is deleted from the user database. If interim accounting is enabled, the controller sends updates at regular intervals. Each interim record includes cumulative user statistics, including received bytes and packets counters.

You can use either the WebUI or CLI to assign a server group for RADIUS accounting.

Using the WebUI

1. Navigate to the **Configuration > Security > Authentication > AAA Profiles** page.
2. Select AAA Profile, then select the AAA profile instance.

- (Optional) In the Profile Details pane, select RADIUS Interim Accounting to allow the controller to send Interim-Update messages with current user statistics to the server at regular intervals. This option is disabled by default, allowing the controller to send only *start* and *stop* messages RADIUS accounting server.
- In the profile list, scroll down and select the Radius Accounting Server Group for the AAA profile. Select the server group from the drop-down menu.
You can add additional servers to the group or configure server rules.
- Click **Apply**.

Using the CLI

```
(host) (config) #aaa profile <profile>
    radius-accounting <group>
    radius-interim-accounting
```

TACACS+ Accounting

TACACS+ accounting allows commands issued on the controller to be reported to TACACS+ servers. You can specify the types of commands that are reported (action, configuration, or show commands) or have all commands reported.

You can configure TACACS+ accounting only with the CLI:

```
(host) (config) #aaa tacacs-accounting server-group <group> command
{action|all|configuration|show} mode {enable|disable}
```

Configuring Authentication Timers

[Table 57](#) describes the timers you can configure that apply to all clients and servers. These timers can be left at their default values for most implementations.

Table 57: Authentication Timers

Timer	Description
User Idle Timeout	Maximum period after which a client is considered idle if there is no wireless traffic from the client. The timeout period is reset if there is wireless traffic. If there is no wireless traffic in the timeout period, the client is aged out. Once the timeout period has expired, the user is removed. If the keyword seconds is not specified, the value defaults to minutes at the command line Range: 1 to 255 minutes (30 to 15300seconds) Default: 5 minutes (300 seconds)
Authentication Server Dead Time	Maximum period, in minutes, that the controller considers an unresponsive authentication server to be “out of service”. This timer is only applicable if there are two or more authentication servers configured on the controller. If there is only one authentication server configured, the server is never considered out of service and all requests are sent to the server. If one or more backup servers are configured and a server is unresponsive, it is marked as out of service for the dead time; subsequent requests are sent to the next server on the priority list for the duration of the dead time. If the server is responsive after the dead time has elapsed, it can take over servicing requests from a lower-priority server; if the server continues to be unresponsive, it is marked as down for the dead time. Range: 0–50 minutes Default: 10 minutes

Timer	Description
Logon User Lifetime	Maximum time, in minutes, unauthenticated clients are allowed to remain logged on. Range: 0–255 Default: 5 minutes
User Interim stats frequency	Set the timeout value for user stats reporting in minutes or seconds. The supported range is 300-600 seconds, or 5-10 minutes, and the default value is 600 seconds.

Setting an Authentication Timer

To set an authentication timer, complete one of the following procedures:

Using the WebUI

1. Navigate to the **Configuration > Security > Authentication > Advanced** page.
2. Configure the timers as described above.
3. Click **Apply** before moving on to another page or closing the browser window. If you do not perform this step, the configuration changes are lost.

Using the CLI

The following commands configure timers you can apply to clients. If the optional seconds keyword is not specified for the **idle-timeout** and **stats-timeout** parameters, the value defaults to minutes.

```
(host)(config) #aaa timers
  dead-time <minutes>
  idle-timeout <time> [seconds]
  logon-lifetime <0-255>
  stats-timeout <time> [seconds]
```

Chapter 13

MAC-based Authentication

This chapter describes how to configure MAC-based authentication on the Dell controller using the WebUI.

Use MAC-based authentication to authenticate devices based on their physical media access control (MAC) address. While not the most secure and scalable method, MAC-based authentication implicitly provides an additional layer of security authentication devices. MAC-based authentication is often used to authenticate and allow network access through certain devices while denying access to the rest. For example, if clients are allowed access to the network via station A, then one method of authenticating station A is MAC-based. Clients may be required to authenticate themselves using other methods depending on the network privileges required.

MAC-based authentication can also be used to authenticate Wi-Fi phones as an additional layer of security to prevent other devices from accessing the voice network using what is normally an insecure SSID.

This chapter describes the following topics:

- ["Configuring MAC-Based Authentication" on page 189](#)
- ["Configuring Clients" on page 190](#)

Configuring MAC-Based Authentication

Before configuring MAC-based authentication, you must configure:

- The user role that will be assigned as the default role for the MAC-based authenticated clients. (See [Roles and Policies on page 296](#) for information on firewall policies to configure roles).
You configure the default user role for MAC-based authentication in the AAA profile. If derivation rules exist or if the client configuration in the internal database has a role assignment, these values take precedence over the default user role.
- Authentication server group that the controller uses to validate the clients. The internal database can be used to configure the clients for MAC-based authentication. See ["Configuring Clients" on page 190](#) for information on configuring the clients on the local database. For information on configuring authentication servers and server groups, see [Authentication Servers on page 168](#)

Configuring the MAC Authentication Profile

[Table 58](#) describes the parameters you can configure for MAC-based authentication.

Table 58: MAC Authentication Profile Configuration Parameters

Parameter	Description
Delimiter	Delimiter used in the MAC string: <ul style="list-style-type: none">• colon specifies the format xx:xx:xx:xx:xx:xx• dash specifies the format xx-xx-xx-xx-xx-xx• none specifies the format xxxxxxxxxxxx Default: none

Parameter	Description
Case	The case (upper or lower) used in the MAC string. Default: lower
Max Authentication failures	Number of times a station can fail to authenticate before it is blacklisted. A value of 0 disables blacklisting. Default: 0

Using the WebUI to configure a MAC authentication profile

1. Navigate to the **Configuration > Security > Authentication > L2 Authentication** page.
2. Select **MAC Authentication Profile**.
3. Enter a profile name and click **Add**.
4. Select the profile name to display configurable parameters.
5. Configure the parameters, as described in [Table 58](#).
6. Click **Apply**.

Using the CLI to configure a MAC authentication profile

```
(host) (configure) #aaa authentication mac <profile>
  case {lower|upper}
  delimiter {colon|dash|none}
  max-authentication-failures <number>
```

Configuring Clients

You can create entries in the controller's internal database that can be used to authenticate client MAC addresses. The internal database contains a list of clients along with the password and default role for each client. To configure entries in the internal database for MAC authentication, you enter the MAC address for both the user name and password for each client.

NOTE: You must enter the MAC address using the delimiter format configured in the MAC authentication profile. The default delimiter is none, which means that MAC addresses should be in the format xxxxxxxxxxxx. If you specify colons for the delimiter, you can enter MAC addresses in the format xx:xx:xx:xx:xx:xx.

In the WebUI

1. Navigate to the **Configuration > Security > Authentication > Servers** page.
2. Select **Internal DB**.
3. Click **Add User** in the **Users** section. The user configuration page displays.
4. For **User Name** and **Password**, enter the MAC address for the client. Use the format specified by the **Delimiter** parameter in the MAC Authentication profile. For example, if the MAC Authentication profile specifies the default delimiter (none), enter MAC addresses in the format xxxxxxxxxxxx.
5. Click **Enabled** to activate this entry on creation.
6. Click **Apply** to apply the configuration.

NOTE: The configuration does not take effect until you perform this step.

In the CLI

Enter the following command in enable mode:

```
(host) (config) #local-userdb add username <macaddr> password <macaddr>...
```

802.1X is an Institute of Electrical and Electronics Engineers (IEEE) standard that provides an authentication framework for WLANs. 802.1x uses the Extensible Authentication Protocol (EAP) to exchange messages during the authentication process. The authentication protocols that operate inside the 802.1X framework that are suitable for wireless networks include EAP-Transport Layer Security (EAP-TLS), Protected EAP (PEAP), and EAP-Tunneled TLS (EAP-TTLS). These protocols allow the network to authenticate the client while also allowing the client to authenticate the network.

This chapter describes the following topics:

- "Understanding 802.1X Authentication" on page 192
- "Configuring 802.1X Authentication" on page 195
- "Sample Configurations" on page 204
- "Performing Advanced Configuration Options for 802.1X" on page 220

Other types of authentication not discussed in this section can be found in the following sections of this guide:

- Captive portal authentication: "Configuring Captive Portal Authentication Profiles" on page 246
- VPN authentication: "Planning a VPN Configuration" on page 271
- MAC authentication: "Configuring MAC-Based Authentication" on page 189
- Stateful 802.1x, stateful NTLM, and WISPr authentication: "Stateful and WISPr Authentication" on page 221

Understanding 802.1X Authentication

802.1x authentication consists of three components:

- The *supplicant*, or client, is the device attempting to gain access to the network. You can configure the Dell user-centric network to support 802.1x authentication for wired users as well as wireless users.
- The *authenticator* is the gatekeeper to the network and permits or denies access to the supplicants.
- The *Dell controller* acts as the authenticator, relaying information between the authentication server and supplicant. The EAP type must be consistent between the authentication server and supplicant and is transparent to the controller.

The authentication server provides a database of information required for authentication and informs the authenticator to deny or permit access to the supplicant.

The 802.1X authentication server is typically an EAP-compliant Remote Access Dial-In User Service (RADIUS) server which can authenticate either users (through passwords or certificates) or the client computer.

An example of an 802.1X authentication server is the Internet Authentication Service (IAS) in Windows (see [http://technet.microsoft.com/en-us/library/cc759077\(WS.10\).aspx](http://technet.microsoft.com/en-us/library/cc759077(WS.10).aspx)).

Dell user-centric networks, you can terminate the 802.1x authentication on the controller. The controller passes user authentication to its internal database or to a "backend" non-802.1X server. This feature, also called *AAA FastConnect*, is useful for deployments where an 802.1X EAP-compliant RADIUS server is not available or required for authentication.

Supported EAP Types

The following is the list of supported EAP types.

- PEAP—Protected EAP (PEAP) is an 802.1X authentication method that uses server-side public key certificates to authenticate clients with server. The PEAP authentication creates an encrypted SSL / TLS tunnel between the client and the authentication server. The exchange of information is encrypted and stored in the tunnel ensuring the user credentials are kept secure.
- EAP-GTC—The EAP-GTC (Generic Token Card) type uses clear text method to exchange authentication controls between client and server. Since the authentication mechanism uses the one-time tokens (generated by the card), this method of credential exchange is considered safe. In addition, EAP-GTC is used in PEAP or TTLS tunnels in wireless environments. The EAP-GTC is described in RFC 2284.
- EAP-AKA—The EAP-AKA (Authentication and Key Agreement) authentication mechanism is typically used in mobile networks that include Universal Mobile Telecommunication Systems (UMTS) and CDMA 2000. This method uses the information stored in the Subscriber Identity Module (SIM) for authentication. The EAP-AKA is described in RFC 4187.
- EAP-FAST—The EAP-FAST (Flexible Authentication via Secure Tunneling) is an alternative authentication method to PEAP. This method uses the Protected Access Credential (PAC) for verifying clients on the network. The EAP-FAST is described in RFC 4851.
- EAP-MD5—The EAP-MD5 method verifies MD5 hash of a user password for authentication. This method is commonly used in a trusted network. The EAP-MD5 is described in RFC 2284.
- EAP-POTP—The EAP type 32 is supported. Complete details are described in RFC 4793.
- EAP-SIM—The EAP-SIM (Subscriber Identity Module) uses Global System for Mobile Communication (GSM) Subscriber Identity Module (SIM) for authentication and session key distribution. This authentication mechanism includes network authentication, user anonymity support, result indication, and fast re-authentication procedure. Complete details about this authentication mechanism is described in RFC 4186.
- EAP-TLS—The EAP-TLS (Transport Layer Security) uses Public key Infrastructure (PKI) to set up authentication with a RADIUS server or any authentication server. This method requires the use of a client-side certificate for communicating with the authentication server. The EAP-TLS is described in RFC 5216.
- EAP-TLV- The EAP-TLV (type-length-value) method allows you to add additional information in an EAP message. Often this method is used to provide more information about a EAP message. For example, status information or authorization data. This method is always used after a typical EAP authentication process.
- EAP-TTLS—The EAP-TTLS (Tunneled Transport Layer Security) method uses server-side certificates to set up authentication between clients and servers. The actually authentication is, however, performed using passwords. Complete details about EAP-TTLS is described in RFC 5281.
- LEAP—Lightweight Extensible Authentication Protocol (LEAP) uses dynamic WEP keys and mutual authentication between client and RADIUS server.
- ZLXEAP—This is Zonelabs EAP. For more information, visit <http://tools.ietf.org/html/draft-bersani-eap-synthesis-sharedkeymethods-00#page-30>.

Configuring Authentication with a RADIUS Server

See [Table 61](#) for an overview of the parameters that you need to configure on authentication components when the authentication server is an 802.1X EAP-compliant RADIUS server.

Figure 59: 802.1X Authentication with RADIUS Server



The supplicant and authentication server must be configured to use the same EAP type. The controller does not need to know the EAP type used between the supplicant and authentication server.

For the controller to communicate with the authentication server, you must configure the IP address, authentication port, and accounting port of the server on the controller. The authentication server must be configured with the IP address of the RADIUS client, which is the controller in this case. Both the controller and the authentication server must be configured to use the same shared secret.



NOTE: Additional information on EAP types supported in a Windows environment, Microsoft supplicants, and authentication server, is available at [http://technet.microsoft.com/en-us/library/cc782851\(WS.10\).aspx](http://technet.microsoft.com/en-us/library/cc782851(WS.10).aspx).

The client communicates with the controller through a GRE tunnel in order to form an association with an AP and to authenticate to the network. Therefore, the network authentication and encryption configured for an ESSID must be the same on both the client and the controller.

Configuring Authentication Terminated on Controller

User authentication is performed either via the controller's internal database or a non-802.1X server. See "[802.1X Authentication Profile Basic WebUI Parameters](#)" on page 196 for an overview of the parameters that you need to configure on 802.1X authentication components when 802.1X authentication is terminated on the controller (AAA FastConnect).

Figure 60: 802.1X Authentication with Termination on Controller



In this scenario, the supplicant is configured for EAP-Transport Layer Security (TLS) or EAP-Protected EAP (PEAP).

- EAP-TLS is used with smart card user authentication. A smart card holds a digital certificate which, with the user-entered personal identification number (PIN), allows the user to be authenticated on the network. EAP-TLS relies on digital certificates to verify the identities of both the client and server.
EAP-TLS requires that you import server and certification authority (CA) certificates onto the controller (see "[Configuring and Using Certificates with AAA FastConnect](#)" on page 200). The client certificate is verified on the controller (the client certificate must be signed by a known CA) before the user name is checked on the authentication server.
- EAP-PEAP uses TLS to create an encrypted tunnel. Within the tunnel, one of the following "inner EAP" methods is used:
 - EAP-Generic Token Card (GTC): Described in RFC 2284, this EAP method permits the transfer of unencrypted usernames and passwords from client to server. The main uses for EAP-GTC are one-time token cards such as SecureID and the use of an LDAP or RADIUS server as the user authentication server. You can also enable caching of user credentials on the controller as a backup to an external authentication server.

- EAP-Microsoft Challenge Handshake Authentication Protocol version 2 (MS-CHAPv2): Described in RFC 2759, this EAP method is widely supported by Microsoft clients. A RADIUS server must be used as the backend authentication server.

If you are using the controller's internal database for user authentication, you need to add the names and passwords of the users to be authenticated. If you are using an LDAP server for user authentication, you need to configure the LDAP server on the controller, and configure user IDs and passwords. If you are using a RADIUS server for user authentication, you need to configure the RADIUS server on the controller.

Configuring 802.1X Authentication

On the controller, use the following steps to configure a wireless network that uses 802.1x authentication:

1. Configure the VLANs to which the authenticated users will be assigned. See ["Network Configuration Parameters" on page 108](#)
2. Configure policies and roles. You can specify a default role for users who are successfully authenticated using 802.1X. You can also configure server derivation rules to assign a user role based on attributes returned by the authentication server; server-derived user roles take precedence over default roles. For more information about policies and roles, see [Roles and Policies on page 296](#).

 NOTE: The Policy Enforcement Firewall Virtual Private Network (PEFV) module provides identity-based security for wired and wireless users and must be installed on the controller. The stateful firewall allows user classification based on user identity, device type, location and time of day and provides differentiated access for different classes of users. For information about obtaining and installing licenses, see ["Software Licenses" on page 100](#).

3. Configure the authentication server(s) and server group. The server can be an 802.1X RADIUS server or, if you are using AAA FastConnect, a non-802.1X server or the controller's internal database. If you are using EAP-GTC within a PEAP tunnel, you can configure an LDAP or RADIUS server as the authentication server (see ["Authentication Servers" on page 168](#)) If you are using EAP-TLS, you need to import server and CA certificates on the controller (see ["Configuring and Using Certificates with AAA FastConnect" on page 200](#)).
4. Configure the AAA profile.
 - Select the 802.1X default user role.
 - Select the server group you previously configured for the 802.1x authentication server group.
5. Configure the 802.1X authentication profile. See ["In the WebUI" on page 215](#)
6. Configure the virtual AP profile for an AP group or for a specific AP:
 - Select the AAA profile you previously configured.
 - In the SSID profile, configure the WLAN for 802.1X authentication.

For details on how to complete the above steps, see ["Sample Configurations" on page 204](#)

In the WebUI

This section describes how to create and configure a new instance of an 802.1X authentication profile in the WebUI or the CLI.

1. Navigate to the **Configuration > Security > Authentication > L2 Authentication** page.
2. In the Profiles list, select 802.1X Authentication Profile.
3. Enter a name for the profile, then click **Add**.
4. Click **Apply**.
5. In the Profiles list, select the 802.1X authentication profile you just created.
6. Change the settings described in [Table 61](#) as desired, then click **Apply**.

The 802.1X authentication profile configuration settings are divided into two tabs, **Basic** and **Advanced**. The **Basic** tab displays only those configuration settings that often need to be adjusted to suit a specific network. The **Advanced** tab shows all configuration settings, including settings that do not need frequent adjustment or should be kept at their default values. If you change a setting on one tab then click and display the other tab without saving your configuration, that setting will revert to its previous value.

Table 61: 802.1x Authentication Profile Basic WebUI Parameters

Parameter	Description
Basic 802.1x Authentication Settings	
Max authentication failures	Number of times a user can try to login with wrong credentials after which the user is blacklisted as a security threat. Set to 0 to disable blacklisting, otherwise enter a non-zero integer to blacklist the user after the specified number of failures. The range of allowed values is 0-5 failures, and the default value is 0 failures. NOTE: This option may require a license.
Enforce Machine Authentication	Select the Enforce Machine Authentication option to require machine authentication. This option is also available on the Basic settings tab. NOTE: This option may require a license.
Machine Authentication: Default Machine Role	Default role assigned to the user after completing only machine authentication. The default role for this setting is the "guest" role.
Machine Authentication: Default User Role	Default role assigned to the user after 802.1x authentication. The default role for this setting is the "guest" role.
Reauthentication	Select the Reauthentication checkbox to force the client to do a 802.1X reauthentication after the expiration of the default timer for reauthentication. (The default value of the timer is 24 hours.) If the user fails to reauthenticate with valid credentials, the state of the user is cleared. If derivation rules are used to classify 802.1x-authenticated users, then the reauthentication timer per role overrides this setting. This option is disabled by default.
Termination	Select the Termination checkbox to allow 802.1X authentication to terminate on the controller. This option is disabled by default.
Termination EAP-Type	If termination is enabled, click either EAP-PEAP or EAP-TLS to select a Extensible Authentication Protocol (EAP) method.
Termination Inner EAP-Type	If you are using EAP-PEAP as the EAP method, specify one of the following inner EAP types: <ul style="list-style-type: none"> ● eap-gtc: Described in RFC 2284, this EAP method permits the transfer of unencrypted usernames and passwords from client to server. The main uses for EAP-GTC are one-time token cards such as SecureID and the use of LDAP or RADIUS as the user authentication server. You can also enable caching of user credentials on the controller as a backup to an external authentication server. ● eap-mschapv2: Described in RFC 2759, this EAP method is widely supported by Microsoft clients.
Enforce Suite-B 128 bit or more security level Authentication	Configure Suite-B 128 bit or more security level authentication enforcement.
Enforce Suite-B 128 bit or more security level Authentication	Configure Suite-B 192 bit security level authentication enforcement.

Parameter	Description
Advanced 802.1x Authentication Settings	
Machine Authentication Cache Timeout	The timeout, in hours, for machine authentication. The allowed range of values is 1-1000 hours, and the default value is 24 hours.
Blacklist on Machine Authentication Failure	Select the Blacklist on Machine Authentication Failure checkbox to blacklist a client if machine authentication fails. This setting is disabled by default
Interval between Identity Requests	Interval, in seconds, between identity request retries. The allowed range of values is 1-65535 seconds, and the default value is 30 seconds.
Quiet Period after Failed Authentication	The enforced quiet period interval, in seconds, following failed authentication. The allowed range of values is 1-65535 seconds, and the default value is 30 seconds.
Reauthentication Interval	Interval, in seconds, between reauthentication attempts. The allowed range of values for this parameter is 60-864000 seconds, and the default value is 86400 seconds (1 day).
Use Server provided Reauthentication Interval	Select this option to override any user-defined reauthentication interval and use the reauthentication period defined by the authentication server.
Multicast Key Rotation Time Interval	Interval, in seconds, between multicast key rotation. The allowed range of values for this parameter is 60-864000 seconds, and the default value is 1800 seconds.
Unicast Key Rotation Time Interval	Interval, in seconds, between unicast key rotation. The allowed range of values for this parameter is 60-864000 seconds, and the default value is 900 seconds.
Authentication Server Retry Interval	Server group retry interval, in seconds. The allowed range of values for this parameter is 5-65535 seconds, and the default value is 30 seconds.
Authentication Server Retry Count	Maximum number of authentication requests that are sent to server group. The allowed range of values for this parameter is 0-3 requests, and the default value is 2 requests.
Framed MTU	Sets the framed Maximum Transmission Unit (MTU) attribute sent to the authentication server. The allowed range of values for this parameter is 500-1500 bytes, and the default value is 1100 bytes.
Number of times ID-Requests are retried	Maximum number of times ID requests are sent to the client. The allowed range of values for this parameter is 1-10 retries, and the default value is 3 retries.
Maximum Number of Reauthentication Attempts	Number of times a user can try to login with wrong credentials after which the user is blacklisted as a security threat. Set to 0 to disable blacklisting, otherwise enter a value from 0-5 to blacklist the user after the specified number of failures. NOTE: If changed from its default value, this may require a license This option may require a license.
Maximum number of times Held State can be bypassed	Number of consecutive authentication failures which, when reached, causes the controller to not respond to authentication requests from a client while the controller is in a held state after the authentication failure. Before this number is reached, the controller responds to authentication requests from the client even while the controller is in its held state. (This parameter is applicable when 802.1X authentication is terminated on the controller, also known as AAA FastConnect.) The allowed range of values for this parameter is 0-3 failures, and the default value is 0.
Dynamic WEP Key Message Retry Count	Set the Number of times WPA/WPA2 Key Messages are retried. The allowed range of values is 1-5 retries, and the default value is 3 retries.

Parameter	Description
Dynamic WEP Key Size	The default dynamic WEP key size is 128 bits, If desired, you can change this parameter to either 40 bits.
Interval between WPA/WPA2 Key Messages	Interval, in milliseconds, between each WPA key exchanges. The allowed range of values is 1000-5000 ms, and the default value is 3000 ms.
Delay between EAP-Success and WPA2 Unicast Key Exchange	Interval, in milliseconds, between EAP-Success and unicast key exchanges. The allowed range of values is 0-2000 ms, and the default value is 0 ms (no delay).
Delay between WPA/WPA2 Unicast Key and Group Key Exchange	Interval, in milliseconds, between unicast and multicast key exchange. Time interval in milliseconds. Range: 0-2000. Default: 0 (no delay)
Time interval after which the PMKSA will be deleted	The time interval after which the PMKSA (Pairwise Master Key Security Association) cache is deleted. Time interval in Hours. Range: 1-2000. Default: 8.
WPA/WPA2 Key Message Retry Count	Number of times WPA/WPA2 key messages are retried. The allowed range of values for this parameter is 1-5 retries, and the default value is 3 retries.
Multicast Key Rotation	Select this checkbox to enable multicast key rotation. This feature is disabled by default.
Unicast Key Rotation	Select this checkbox to enable unicast key rotation. This feature is disabled by default.
Opportunistic Key Caching	By default, the 802.1X authentication profile enables a cached pairwise master key (PMK) derived via a client and an associated AP and used when the client roams to a new AP. This allows clients faster roaming without a full 802.1x authentication. Uncheck this option to disable this feature. NOTE: Make sure that the wireless client (the 802.1X supplicant) supports this feature. If the client does not support this feature, the client will attempt to renegotiate the key whenever it roams to a new AP. As a result, the key cached on the controller can be out of sync with the key used by the client.
Validate PMKID	This parameter instructs the controller to check the pairwise master key (PMK) ID sent by the client. When this option is enabled, the client must send a PMKID in the associate or reassociate frame to indicate that it supports OKC or PMK caching; otherwise, full 802.1x authentication takes place. NOTE: This feature is optional, since most clients that support OKC and PMK caching do not send the PMKID in their association request.
Use Session Key	Select the Use Session Key option to use the RADIUS session key as the unicast WEP key. This option is disabled by default.
Use Static Key	Select the Use Static Key option to use a static key as the unicast/multicast WEP key. This option is disabled by default.
xSec MTU	Set the maximum transmission unit (MTU) for frames using the xSec protocol. The range of allowed values is 1024-1500 bytes, and 1300 bytes
Token Caching	If you select EAP-GTC as the inner EAP method, you can select the Token Caching checkbox to enable the controller to cache the username and password of each authenticated user. The controller continues to reauthenticate users with the remote authentication server, however, if the authentication server is not available, the controller will inspect its cached credentials to reauthenticate users. This option is disabled by default.
Token Caching Period	If you select EAP-GTC as the inner EAP method, you can specify the timeout period, in hours,

Parameter	Description
	for the cached information. The default value is 24 hours.
CA-Certificate	Click the CA-Certificate drop-down list and select a certificate for client authentication. The CA certificate needs to be loaded in the controller before it will appear on this list.
Server-Certificate	Click the Server-Certificate drop-down list and select a server certificate the controller will use to authenticate itself to the client.
TLS Guest Access	Select TLS Guest Access to enable guest access for EAP-TLS users with valid certificates. This option is disabled by default.
TLS Guest Role	Click the TLS Guest Role drop-down list and select the default user role for EAP-TLS guest users. This option may require a license This option may require a license.
Ignore EAPOL-START after authentication	Select Ignore EAPOL-START after authentication to ignore EAPOL-START messages after authentication. This option is disabled by default.
Handle EAPOL-Logoff	Select Handle EAPOL-Logoff to enable handling of EAPOL-LOGOFF messages. This option is disabled by default.
Ignore EAP ID during negotiation	Select Ignore EAP ID during negotiation to ignore EAP IDs during negotiation. This option is disabled by default.
WPA-Fast-Handover	Select this option to enable WPA-fast-handover on phones that support this feature. WAP fast-handover is disabled by default.
Disable rekey and reauthentication for clients on call	This feature disables rekey and reauthentication for VoWLAN clients. It is disabled by default, meaning that rekey and reauthentication is enabled. NOTE: This option may require a license This option may require a license.
Check certificate common name against AAA server	If you use client certificates for user authentication, enable this option to verify that the certificate's common name exists in the server. This parameter is enabled by default in the default-cap and default-rap VPN profiles, and disabled by default on all other VPN profiles.

In the CLI

The following command configures settings for an 802.1X authentication profiles. Individual parameters are described in the previous table.

```
(host) (config) #aaa authentication dot1x {<profile>|countermeasures}
  ca-cert <certificate>
  clear
  clone <profile>
  eapol-logoff
  framed-mtu <mtu>
  heldstate-bypass-counter <number>
  ignore-eap-id-match
  ignore-eapolstart-afterauthentication
  machine-authentication blacklist-on-failure|{cache-timeout <hours>}|enable|
  {machine-default-role <role>}|{user-default-role <role>}
  max-authentication-failures <number>
  max-requests <number>
  multicast-keyrotation
  no ...
  opp-key-caching
  reauth-max <number>
  reauthentication
  server {server-retry <number>|server-retry-period <seconds>}
  server-cert <certificate>
```

```

termination {eap-type <type>}|enable|enable-token-caching|{inner-eap-type (eapg|
eap-mschapv2)}|{token-caching-period <hours>}
timer {idle-request-period <seconds>}|{mkey-rotation-period <seconds>}|{quiet-period
<seconds>}|{reauth-period <seconds>}|{ukey-rotation-period <seconds>}|{wpa-groupkey-
delay <seconds>}|{wpa-key-period <milliseconds>}
tls-guest-access
tls-guest-role <role>
unicast-keyrotation
use-session-key
use-static-key
validate-pmkid
voice-aware
wep-key-retries <number>
wep-key-size {40|128}
wpa-fast-handover
wpa-key-retries <number>
xSec-mtu <mtu>

```

Configuring and Using Certificates with AAA FastConnect

The controller supports 802.1x authentication using digital certificates for AAA FastConnect.

- **Server Certificate**—A server certificate installed in the controller verifies the authenticity of the controller for 802.1x authentication. Dell controllers ship with a demonstration digital certificate. Until you install a customer-specific server certificate in the controller, this demonstration certificate is used by default for all secure HTTP connections (such as the WebUI and captive portal) and AAA FastConnect. This certificate is included primarily for the purposes of feature demonstration and convenience and is not intended for long-term use in production networks. Users in a production environment are urged to obtain and install a certificate issued for their site or domain by a well-known certificate authority (CA). You can generate a Certificate Signing Request (CSR) on the controller to submit to a CA. For information on how to generate a CSR and how to import the CA-signed certificate into the controller, see ["Managing Certificates" on page 635](#)
- **Client Certificates**—Client certificates are verified on the controller (the client certificate must be signed by a known CA) before the user name is checked on the authentication server. To use client certificate authentication for AAA FastConnect, you need to import the following certificates into the controller (see ["Importing Certificates" on page 637](#)):
 - Controller's server certificate
 - CA certificate for the CA that signed the client certificates

In the WebUI

1. Navigate to the **Configuration > Security > Authentication > L2 Authentication** page.
2. In the Profiles list, select **802.1x Authentication Profile**.
3. Select the "default" 802.1x authentication profile from the drop-down menu to display configuration parameters.
4. In the **Basic** tab, select **Termination**.
5. Select the **Advanced** Tab.
6. In the Server-Certificate field, select the server certificate imported into the controller.
7. In the CA-Certificate field, select the CA certificate imported into the controller.
8. Click **Save As**. Enter a name for the 802.1x authentication profile.
9. Click **Apply**.

In the CLI

```

(host) (config) #aaa authentication dot1x <profile>
termination enable

```



```
server-cert <certificate>
ca-cert <certificate>
```

Configuring User and Machine Authentication

When a Windows device boots, it logs onto the network domain using a machine account. Within the domain, the device is authenticated before computer group policies and software settings can be executed; this process is known as *machine authentication*. Machine authentication ensures that only authorized devices are allowed on the network.

You can configure 802.1x for both user and machine authentication (select the **Enforce Machine Authentication** option described in [Table 61](#)). This tightens the authentication process further since both the device and user need to be authenticated.

Working with Role Assignment with Machine Authentication Enabled

When you enable machine authentication, there are two additional roles you can define in the 802.1x authentication profile:

- Machine authentication default machine role
- Machine authentication default user role

While you can select the same role for both options, you should define the roles as per the policies that need to be enforced. Also, these roles can be different from the 802.1x authentication default role configured in the AAA profile.

With machine authentication enabled, the assigned role depends upon the success or failure of the machine and user authentications. In certain cases, the role that is ultimately assigned to a client can also depend upon attributes returned by the authentication server or server derivation rules configured on the controller.

[Table 62](#) describes role assignment based on the results of the machine and user authentications.

Table 62: Role Assignment for User and Machine Authentication

Machine Auth Status	User Auth Status	Description	Role Assigned
Failed	Failed	Both machine authentication and user authentication failed. L2 authentication failed.	No role assigned. No access to the network allowed.
Failed	Passed	Machine authentication fails (for example, the machine information is not present on the server) and user authentication succeeds. Server-derived roles do not apply.	Machine authentication default user role configured in the 802.1x authentication profile.
Passed	Failed	Machine authentication succeeds and user authentication has not been initiated. Server-derived roles do not apply.	Machine authentication default machine role configured in the 802.1x authentication profile.
Passed	Passed	Both machine and user are successfully authenticated. If there are server-derived roles, the role assigned via the derivation take precedence. This is the <i>only</i> case where server-derived roles are applied.	A role derived from the authentication server takes precedence. Otherwise, the 802.1x authentication default role configured in the AAA profile is assigned.

For example, if the following roles are configured:

- 802.1x authentication default role (in AAA profile): dot1x_user
- Machine authentication default machine role (in 802.1x authentication profile): dot1x_mc

- Machine authentication default user role (in 802.1x authentication profile): guest

Role assignments would be as follows:

- If both machine and user authentication succeed, the role is dot1x_user. If there is a server-derived role, the server-derived role takes precedence.
- If only machine authentication succeeds, the role is dot1x_mc.
- If only user authentication succeeds, the role is guest.
- On failure of both machine and user authentication, the user does not have access to the network.

With machine authentication enabled, the VLAN to which a client is assigned (and from which the client obtains its IP address) depends upon the success or failure of the machine and user authentications. The VLAN that is ultimately assigned to a client can also depend upon attributes returned by the authentication server or server derivation rules configured on the controller (see "[Understanding VLAN Assignments](#)" on page 117). If machine authentication is successful, the client is assigned the VLAN configured in the virtual AP profile. However, the client can be assigned a derived VLAN upon successful user authentication.



NOTE: You can optionally assign a VLAN as part of a user role configuration. You should not use VLAN derivation if you configure user roles with VLAN assignments

[Table 63](#) describes VLAN assignment based on the results of the machine and user authentications when VLAN derivation is used.

Table 63: *VLAN Assignment for User and Machine Authentication*

Machine Auth Status	User Auth Status	Description	VLAN Assigned
Failed	Failed	Both machine authentication and user authentication failed. L2 authentication failed.	No VLAN
Failed	Passed	Machine authentication fails (for example, the machine information is not present on the server) and user authentication succeeds.	VLAN configured in the virtual AP profile
Passed	Failed	Machine authentication succeeds and user authentication has not been initiated.	VLAN configured in the virtual AP profile
Passed	Passed	Both machine and user are successfully authenticated.	Derived VLAN. Otherwise, VLAN configured in the virtual AP profile.



NOTE: The administrator can now associate a VLAN Id to a client data based on the authentication credentials in a bridge mode.

Enabling 802.1x Supplicant Support on an AP

This release of ArubaOS provides 802.1X supplicant support on the Access Point (AP). The AP can be used as a 802.1x supplicant where access to the wired Ethernet network is restricted to those devices that can authenticate using 802.1x. You can provision an AP to act as an 802.1X supplicant and authenticate to the infrastructure using the PEAP protocol.



NOTE: Both Campus APs (CAPs) and Remote APs (RAPs) can be provisioned to use 802.1X authentication.

Prerequisites

- An AP has to be configured with the credentials for 802.1X authentication. These credentials are stored securely in the AP flash.
- The AP must complete the 802.1X authentication before it sends or receives IP traffic such as DHCP.



NOTE: If the AP cannot complete 802.1x authentication (explicit failure or reply timeout) within 1 minute, the AP will proceed to initiate the IP traffic and attempt to contact the controller. The infrastructure can be configured to allow this. If the AP contacts the controller it will be marked as unprovisioned so that the administrator can take corrective action.

Provisioning an AP as a 802.1X Supplicant

This section describes how an AP can be provisioned as a 802.1X supplicant using CLI or the WebUI.

In the WebUI

To provision an AP as a 802.1X supplicant using the WebUI, follow these steps:

1. Navigate to the **Configuration > Wireless > AP Installation > Provisioning** window. The list of discovered APs are displayed on this page.
2. Select the AP you want to provision.
3. Click **Provision**. The provisioning window opens.
4. Select the **802.1x Parameters using PEAP** checkbox and enter the following credentials:
 - a. User Name: Enter the user name of the AP in the **User Name** field.
 - b. Password: Enter the password of the AP in the **Password** field.
5. Enter the password again in the **Confirm Password** field and reconfirm it.
6. Click **Apply and Reboot** (at the bottom of the page).

In the CLI

To provision an AP as a 802.1X supplicant using the CLI, enter the following commands in the config mode:

```
(host) (config)# provision-ap
(host) (AP provisioning) # apdot1x-username <username>
(host) (AP provisioning) # apdot1x-passwd <password>
(host) (AP provisioning) # reprovision ap-name <apname>
```

To view the 802.1x authentication details on the controller:

```
(host) # show ap active
Active AP Table
-----
Name          Group  IP Address  11g Clients  11g Ch/EIRP/MaxEIRP  11a Clients  11a
Ch/EIRP/MaxEIRP AP Type  Flags  Uptime  Outer IP
-----
AP1X          default  10.3.15.107  0          AP:HT:1/15/21.5    0
AP:HT:44/15/21 125     1E2     5m:48s  N/A
```

```
Flags: a = Reduce ARP packets in the air; A = Enet1 in active/standby mode;
       B = Battery Boost On; C = Cellular; D = Disconn. Extra Calls On;
       d = Drop Mcast/Bcast On; E = Wired AP enabled; K = 802.11K Enabled;
       L = Client Balancing Enabled; M = Mesh; N = 802.11b protection disabled;
       P = PPPOE; R = Remote AP; X = Maintenance Mode;
```

1 = 802.1x authenticated AP; 2 = Using IKE version 2;

Sample Configurations

The following examples show basic configurations on the controller for:

- ["Configuring Authentication with an 802.1X RADIUS Server" on page 204](#)
- ["Configuring Authentication with the Controller's Internal Database" on page 214](#)

In the following examples:

- Wireless clients associate to the ESSID **WLAN-01**.
- The following roles allow different networks access capabilities:
 - student
 - faculty
 - guest
 - system administrators

The examples show how to configure using the WebUI and CLI commands.

Configuring Authentication with an 802.1X RADIUS Server

- An EAP-compliant RADIUS server provides the 802.1X authentication. The RADIUS server administrator must configure the server to support this authentication. The administrator must also configure the server to all communications with the Dell controller.
- The authentication type is WPA. From the 802.1X authentication exchange, the client and the controller derive dynamic keys to encrypt data transmitted on the wireless network.
- 802.1x authentication based on PEAP with MS-CHAPv2 provides both computer and user authentication. If a user attempts to log in without the computer being authenticated first, the user is placed into a more limited "guest" user role.

Windows domain credentials are used for computer authentication, and the user's Windows login and password are used for user authentication. A single user sign-on facilitates both authentication to the wireless network and access to the Windows server resources.



NOTE: ["" on page 842](#) describes how to configure the Microsoft Internet Authentication Server and Windows XP wireless client to operate with the controller configuration shown in this section.

Configuring Roles and Policies

You can create the following policies and user roles for:

- Student
- Faculty
- Guest
- Sysadmin
- Computer

Creating the Student Role and Policy

The **student** policy prevents students from using telnet, POP3, FTP, SMTP, SNMP, or SSH to the wired portion of the network. The **student** policy is mapped to the **student** user role.

In the WebUI

1. Navigate to the **Configuration > Security > Access Control > Policies** page. Select **Add** to add the student policy.
2. For Policy Name, enter **student**.
3. For Policy Type, select **IPv4 Session**.
4. Under Rules, select **Add** to add rules for the policy.
 - a. Under Source, select **user**.
 - b. Under Destination, select **alias**.



NOTE: The following step defines an alias representing all internal network addresses. Once defined, you can use the alias for other rules and policies.

- c. Under the alias selection, click **New**. For Destination Name, enter "Internal Network". Click **Add** to add a rule. For Rule Type, select **network**. For IP Address, enter 10.0.0.0. For Network Mask/Range, enter 255.0.0.0. Click **Add** to add the network range. Repeat these steps to add the network range 172.16.0.0 255.255.0.0. Click **Done**. The alias "Internal Network" appears in the Destination menu. This step defines an alias representing all internal network addresses. Once defined, you can use the alias for other rules and policies.
 - d. Under Destination, select **Internal Network**.
 - e. Under Service, select **service**. In the Service scrolling list, select **svc-telnet**.
 - f. Under Action, select **drop**.
 - g. Click **Add**.
5. Under Rules, click **Add**.
 - a. Under Source, select **user**.
 - b. Under Destination, select **alias**. Then select **Internal Network**.
 - c. Under Service, select **service**. In the Service scrolling list, select **svc-pop3**.
 - d. Under Action, select **drop**.
 - e. Click **Add**.
 6. Repeat steps 4A-E to create rules for the following services: **svc-ftp**, **svc-smtp**, **svc-snmp**, and **svc-ssh**.
 7. Click **Apply**.
 8. Click the **User Roles** tab. Click **Add** to create the student role.
 9. For Role Name, enter **student**.
 10. Under Firewall Policies, click **Add**. In Choose from Configured Policies, select the student policy you previously created. Click **Done**.
 11. Click **Apply**.

In the CLI

```
(host) (config) #ip access-list session student
    user alias "Internal Network" svc-telnet deny
    user alias "Internal Network" svc-pop3 deny
    user alias "Internal Network" svc-ftp deny
    user alias "Internal Network" svc-smtp deny
    user alias "Internal Network" svc-snmp deny
    user alias "Internal Network" svc-ssh deny
```

```
(host) (config) #user-role student
    session-acl student
    session-acl allowall
```

Creating the Faculty Role and Policy

The **faculty** policy is similar to the **student** policy, however faculty members are allowed to use POP3 and SMTP for VPN remote access from home. (Students are not permitted to use VPN remote access.) The **faculty** policy is mapped to the **faculty** user role.

Using the WebUI

1. Navigate to the **Configuration > Security > Access Control > Policies** page. Click **Add** to add the faculty policy.
2. For Policy Name, enter **faculty**.
3. For Policy Type, select **IPv4 Session**.
4. Under Rules, click **Add** to add rules for the policy.
 - a. Under Source, select **user**.
 - b. Under Destination, select alias, then select **Internal Network**.
 - c. Under Service, select **service**. In the Service scrolling list, select **svc-telnet**.
 - d. Under Action, select **drop**.
 - e. Click **Add**.
 - f. Repeat steps A-E to create rules for the following services: **svc-ftp**, **svc-snmp**, and **svc-ssh**.
5. Click **Apply**.
6. Select the **User Roles** tab. Click **Add** to create the faculty role.
7. For Role Name, enter **faculty**.
8. Under **Firewall Policies**, click **Add**. In Choose from Configured Policies, select the faculty policy you previously created. Click **Done**.

In the CLI

```
(host)(config) #ip access-list session faculty
    user alias "Internal Network" svc-telnet deny
    user alias "Internal Network" svc-ftp deny
    user alias "Internal Network" svc-snmp deny
    user alias "Internal Network" svc-ssh deny
```

```
(host)(config) #user-role faculty
    session-acl faculty
    session-acl allowall
```

Creating the Guest Role and Policy

The **guest** policy permits only access to the Internet (via HTTP or HTTPS) and only during daytime working hours. The **guest** policy is mapped to the **guest** user role.

In the WebUI

1. Navigate to the **Configuration > Security > Access Control > Time Ranges** page to define the time range "working-hours". Click **Add**.
 - a. For Name, enter **working-hours**.
 - b. For Type, select **Periodic**.
 - c. Click **Add**.
 - d. For Start Day, click **Weekday**.
 - e. For Start Time, enter **07:30**.
 - f. For End Time, enter **17:00**.

- g. Click **Done**.
- h. Click **Apply**.
2. Click the **Policies** tab. Click **Add** to add the guest policy.
3. For **ePolicy Name**, enter **guest**.
4. For **Policy Type**, select **IPv4 Session**.
5. Under **Rules**, click **Add** to add rules for the policy.

To create rules to permit access to DHCP and DNS servers during working hours:

 - a. Under **Source**, select **user**.
 - b. Under **Destination**, select **host**. In **Host IP**, enter **10.1.1.25**.
 - c. Under **Service**, select **service**. In the **Service** scrolling list, select **svc-dhcp**.
 - d. Under **Action**, select **permit**.
 - e. Under **Time Range**, select **working-hours**.
 - f. Click **Add**.
 - g. Repeat steps A-F to create a rule for *svc-dns*.

To create a rule to deny access to the internal network:

 - a. Under **Source**, select **user**.
 - b. Under **Destination**, select **alias**. Select **Internal Network**.
 - c. Under **Service**, select **any**.
 - d. Under **Action**, select **drop**.
 - e. Click **Add**.

To create rules to permit HTTP and HTTPS access during working hours:

 - a. Under **Source**, select **user**.
 - b. Under **Destination**, select **any**.
 - c. Under **Service**, select **service**. In the **Services** scrolling list, select **svc-http**.
 - d. Under **Action**, select **permit**.
 - e. Under **Time Range**, select **working-hours**.
 - f. Click **Add**.
 - g. Repeat steps A-F for the *svc-https* service.

To create a rule that denies the user access to all destinations and all services:

 - a. Under **Source**, select **user**.
 - b. Under **Destination**, select **any**.
 - c. Under **Service**, select **any**.
 - d. Under **Action**, select **drop**.
 - e. Click **Add**.
6. Click **Apply**.
7. Click the **User Roles** tab. Click **Add** to create the guest role.
8. For **Role Name**, enter **guest**.
9. Under **Firewall Policies**, click **Add**. In **Choose from Configured Policies**, select the guest policy you previously created. Click **Done**.

In the CLI

```
time-range working-hours periodic
  weekday 07:30 to 17:00
```

```
(host) (config) #ip access-list session guest
    user host 10.1.1.25 svc-dhcp permit time-range working-hours
    user host 10.1.1.25 svc-dns permit time-range working-hours
    user alias "Internal Network" any deny
    user any svc-http permit time-range working-hours
    user any svc-https permit time-range working-hours
    user any any deny
```

```
(host) (config) #user-role guest
    session-acl guest
```

Creating Roles and Policies for Sysadmin and Computer

- The **allowall** policy, a predefined policy, allows unrestricted access to the network. The **allowall** policy is mapped to both the **sysadmin** user role and the **computer** user role.

In the WebUI

1. Navigate to **Configuration > Security > Access Control > User Roles** page. Click **Add** to create the **sysadmin** role.
2. For Role Name, enter **sysadmin**.
3. Under Firewall Policies, click **Add**. In Choose from Configured Policies, select the predefined **allowall** policy. Click **Done**.
4. Click **Apply**.

In the CLI

```
(host) (config) #user-role sysadmin
    session-acl allowall
```

Using the WebUI to create the computer role

1. Navigate to **Configuration > Security > Access Control > User Roles** page. Click **Add** to create the **computer** role.
2. For Role Name, enter **computer**.
3. Under Firewall Policies, click **Add**. In Choose from Configured Policies, select the predefined **allowall** policy. Click **Done**.
4. Click **Apply**.

Using the CLI to create the computer role

```
(host) (config) #user-role computer
    session-acl allowall
```

Creating an Alias for the Internal Network Using the CLI

```
(host) (config) #netdestination "Internal Network"
    network 10.0.0.0 255.0.0.0
    network 172.16.0.0 255.255.0.0
```

Configuring the RADIUS Authentication Server

Configure the RADIUS server IAS1, with IP address 10.1.1.21 and shared key. The RADIUS server is configured to sent an attribute called Class to the controller; the value of this attribute is set to either "student," "faculty," or "sysadmin" to identify the user's group. The controller uses the literal value of this attribute to determine the role name.

On the controller, you add the configured server (IAS1) into a server group. For the server group, you configure the server rule that allows the Class attribute returned by the server to set the user role.

In the WebUI

1. Navigate to the **Configuration > Security > Authentication > Servers** page.
2. In the Servers list, select Radius Server. In the RADIUS Server Instance list, enter **IAS1** and click **Add**.
 - a. Select IAS1 to display configuration parameters for the RADIUS server.
 - b. For IP Address, enter **10.1.1.21**.
 - c. For Key, enter **|*a^t%183923!**. (You must enter the key string twice.)
 - d. Click **Apply**.
3. In the Servers list, select Server Group. In the Server Group Instance list, enter **IAS** and click **Add**.
 - a. Select the server group IAS to display configuration parameters for the server group.
 - b. Under Servers, click **New**.
 - c. From the Server Name drop-down menu, select IAS1. Click **Add Server**.
4. Under Server Rules, click **New**.
 - a. For Condition, enter **Class**.
 - b. For Attribute, select **value-of** from the drop-down menu.
 - c. For Operand, select **set role**.
 - d. Click **Add**.
5. Click **Apply**.

In the CLI

```
(host) (config) #aaa authentication-server radius IAS1
  host 10.1.1.21
  key |*a^t%183923!
```

```
(host) (config) #aaa server-group IAS
  auth-server IAS1
  set role condition Class value-of
```

Configuring 802.1X Authentication

An AAA profile specifies the 802.1X authentication profile and 802.1x server group to be used for authenticating clients for a WLAN. The AAA profile also specifies the default user roles for 802.1X and MAC authentication.

In the 802.1X authentication profile, configure enforcement of machine authentication before user authentication. If a user attempts to log in without machine authentication taking place first, the user is placed in the limited guest role.

In the WebUI

1. Navigate to the **Configuration > Security > Authentication > L2 Authentication** page.
2. Select 802.1X Authentication Profile.
 - a. At the bottom of the **Instance** list, enter **dot1x**, then click **Add**.
 - b. Select the profile name you just added.
 - c. Select **Enforce Machine Authentication**.
 - d. For the Machine Authentication: Default Machine Role, select **computer**.
 - e. For the Machine Authentication: Default User Role, select **guest**.
 - f. Click **Apply**.

3. Select the **AAA Profiles** tab.
 - a. In the AAA Profiles Summary, click **Add** to add a new profile.
 - b. Enter **aaa_dot1x**, then click **Add**.
 - a. Select the profile name you just added.
 - b. For MAC Auth Default Role, select **computer**.
 - c. For 802.1x Authentication Default Role, select **faculty**.
 - d. Click **Apply**.
4. In the Profiles list (under the aaa_dot1x profile), select 802.1x Authentication Profile.
 - a. From the drop-down menu, select the **dot1x** 802.1x authentication profile you configured previously.
 - b. Click **Apply**.
5. In the Profiles list (under the aaa_dot1x profile), select 802.1x Authentication Server Group.
 - a. From the drop-down menu, select the IAS server group you created previously.
 - b. Click **Apply**.

In the CLI

```
(host)(config) #aaa authentication dot1x dot1x
machine-authentication enable
machine-authentication machine-default-role computer
machine-authentication user-default-role guest
```

```
(host)(config) #aaa profile aaa_dot1x
d>ot1x-default-role faculty
mac-default-role computer
authentication-dot1x dot1x
d>ot1x-server-group IAS
```

Configuring VLANs

In this example, wireless clients are assigned to either VLAN 60 or 61 while guest users are assigned to VLAN 63. VLANs 60 and 61 split users into smaller IP subnetworks, improving performance by decreasing broadcast traffic. The VLANs are internal to the Dell controller only and do not extend into other parts of the wired network. The clients' default gateway is the Dell controller, which routes traffic out to the 10.1.1.0 subnetwork.

You configure the VLANs, assign IP addresses to each VLAN, and establish the "helper address" to which client DHCP requests are forwarded.

In the WebUI

1. Navigate to the **Configuration > Network > VLANs** page. Click **Add** to add VLAN 60.
 - a. For VLAN ID, enter **60**.
 - b. Click **Apply**.
 - c. Repeat steps A and B to add VLANs 61 and 63.
2. To configure IP parameters for the VLANs, navigate to the **Configuration > Network > IP > IPInterfaces** page.
 - a. Click **Edit** for VLAN 60.
 - b. For IP Address, enter **10.1.60.1**.
 - c. For Net Mask, enter **255.255.255.0**.
 - d. Under DHCP Helper Address, click **Add**. Enter **10.1.1.25** and click **Add**.
 - e. Click **Apply**.

3. In the IP Interfaces page, click **Edit** for VLAN 61.
 - a. For IP Address, enter 10.1.61.1.
 - b. For Net Mask, enter 255.255.255.0.
 - c. Under DHCP Helper Address, click **Add**. Enter 10.1.1.25 and click **Add**.
 - d. Click **Apply**.
4. In the IP Interfaces page, click **Edit** for VLAN 63.
 - a. For IP Address, enter 10.1.63.1.
 - b. For Net Mask, enter 255.255.255.0.
 - c. Under DHCP Helper Address, click **Add**. Enter 10.1.1.25 and click **Add**.
 - d. Click **Apply**.
5. Select the **IP Routes** tab.
 - a. For Default Gateway, enter 10.1.1.254.
 - b. Click **Apply**.

In the CLI

```
(host) (config) #vlan 60
(host) (config) #interface vlan 60
ip address 10.1.60.1 255.255.255.0
ip helper-address 10.1.1.25

(host) (config) #vlan 61
(host) (config) #interface vlan 61
ip address 10.1.61.1 255.255.255.0
ip helper-address 10.1.1.25

(host) (config) #vlan 63
(host) (config) #interface vlan 63
ip address 10.1.63.1 255.255.255.0
ip helper-address 10.1.1.25

(host) (config) #ip default-gateway 10.1.1.254
```

Configuring the WLANs

In this example, default AP parameters for the entire network are as follows: the default ESSID is WLAN-01 and the encryption mode is TKIP. A second ESSID called “guest” has the encryption mode set to static WEP with a configured WEP key.

In this example, the non-guest clients that associate to an AP are mapped into one of two different user VLANs. The initial AP to which the client associates determines the VLAN: clients that associate to APs in the first floor of the building are mapped to VLAN 60 and clients that associate to APs in the second floor of the building are mapped to VLAN 61. Therefore, the APs in the network are segregated into two AP groups, named “first-floor” and “second-floor”. (See ["Creating an AP group" on page 395](#) for information about creating AP groups.) The guest clients are mapped into VLAN 63.

Configuring the Guest WLAN

You create and configure the virtual AP profile “guest” and apply the profile to each AP group. The “guest” virtual AP profile contains the SSID profile “guest” which configures static WEP with a WEP key.

In the WebUI

1. Navigate to the **Configuration > Wireless > AP Configuration** page.

2. In the AP Group list, click **Edit** for first-floor.
3. Under Profiles, select Wireless LAN, then select Virtual AP.
4. To create the guest virtual AP:
 - a. Select NEW from the Add a profile drop-down menu. Enter **guest**, and click **Add**.
 - b. In the Profile Details entry for the guest virtual AP profile, select NEW from the SSID profile drop-down menu. A pop-up window allows you to configure the SSID profile.
 - c. For the name for the SSID profile enter **guest**.
 - d. For the Network Name for the SSID, enter **guest**.
 - e. For Network Authentication, select **None**.
 - f. For Encryption, select **WEP**.
 - g. Enter the WEP Key.
 - h. Click **Apply** to apply the SSID profile to the Virtual AP.
 - i. Under Profile Details, click **Apply**.
5. Click on the **guest** virtual AP name in the Profiles list or in Profile Details to display configuration parameters.
 - a. Make sure Virtual AP enable is selected.
 - b. For VLAN, select **63**.
 - c. Click **Apply**.
6. Navigate to the **Configuration > Wireless > AP Configuration** page.
7. In the AP Group list, click **Edit** for the second-floor.
8. In the Profiles list, select Wireless LAN, then select Virtual AP.
9. Select **guest** from the Add a profile drop-down menu. Click **Add**.
10. Click **Apply**.

In the CLI

```
(host)(config) #wlan ssid-profile guest
    essid guest
    wepkey1 aaaaaaaaaa
    opmode static-wep

(host)(config) #wlan virtual-ap guest
    vlan 63
    ssid-profile guest

(host)(config) #ap-group first-floor
    virtual-ap guest
(host)(config) #ap-group second-floor
    virtual-ap guest
```

Configuring the Non-Guest WLANs

You create and configure the SSID profile “WLAN-01” with the ESSID “WLAN-01” and WPA TKIP encryption. You need to create and configure two virtual AP profiles: one with VLAN 60 for the first-floor AP group and the other with VLAN 61 for the second-floor AP group. Each virtual AP profile references the SSID profile “WLAN-01” and the previously-configured AAA profile “aaa_dot1x”.

In the WebUI

1. Navigate to the **Configuration > Wireless > AP Configuration** page.
2. In the AP Group list, click **Edit** for the first-floor.

3. In the Profiles list, select Wireless LAN, then select Virtual AP.
4. To configure the WLAN-01_first-floor virtual AP:
 - a. Select NEW from the Add a profile drop-down menu. Enter **WLAN-01_first-floor**, and click **Add**.
 - b. In the Profile Details entry for the WLAN-01_first-floor virtual AP profile, select the **aaa_dot1x** AAA profile you previously configured. A pop-up window displays the configured AAA profile parameters. Click **Apply** in the pop-up window.
 - c. From the SSID profile drop-down menu, select NEW. A pop-up window allows you to configure the SSID profile.
 - d. Enter **WLAN-01** for the name of the SSID profile.
 - e. For Network Name, enter **WLAN-01**.
 - f. For Network Authentication, select **WPA**.
 - g. Click **Apply** in the pop-up window.
 - h. At the bottom of the Profile Details page, click **Apply**.
5. Click on the WLAN-01_first-floor virtual AP name in the Profiles list or in Profile Details to display configuration parameters.
 - a. Make sure Virtual AP enable is selected.
 - b. For VLAN, select 60.
 - c. Click **Apply**.
6. Navigate to the **Configuration > Wireless > AP Configuration** page.
7. In the AP Group list, click **Edit** for the second-floor.
8. In the Profiles list, select Wireless LAN, then select Virtual AP.
9. To configure the WLAN-01_second-floor virtual AP:
 - a. Select NEW from the Add a profile drop-down menu. Enter **WLAN-second-floor**, and click **Add**.
 - b. In the Profile Details entry for the virtual AP profile, select **aaa_dot1x** from the AAA profile drop-down menu. A pop-up window displays the configured AAA profile parameters. Click **Apply** in the pop-up window.
 - c. From the SSID profile drop-down menu, select **WLAN-01**. A pop-up window displays the configured SSID profile parameters. Click **Apply** in the pop-up window.
 - d. At the bottom of the Profile Details page, click **Apply**.
10. Click on the new virtual AP name in the Profiles list or in Profile Details to display configuration parameters.
 - a. Make sure Virtual AP enable is selected.
 - b. For VLAN, select 61.
 - c. Click **Apply**.

In the CLI

```
(host)(config) #wlan ssid-profile WLAN-01
    essid WLAN-01
    opmode wpa-tkip
```

```
(host)(config) #wlan virtual-ap WLAN-01_first-floor
    vlan 60
    aaa-profile aaa_dot1x
    ssid-profile WLAN-01
```

```
(host)(config) #wlan virtual-ap WLAN-01_second-floor
    vlan 61
    aaa-profile aaa_dot1x
    ssid-profile WLAN-01
```

```
(host) (config) #ap-group first-floor
    virtual-ap WLAN-01_first-floor
    ap-group second-floor
    virtual-ap WLAN-01_second-floor
```

Configuring Authentication with the Controller's Internal Database

In the following example:

- The controller's internal database provides user authentication.
- The authentication type is WPA. From the 802.1x authentication exchange, the client and the controller derive dynamic keys to encrypt data transmitted on the wireless network.

Configuring the Internal Database

Configure the internal database with the username, password, and role (student, faculty, or sysadmin) for each user. There is a default **internal** server group that includes the internal database. For the internal server group, configure a server derivation rule that assigns the role to the authenticated client.

In the WebUI

1. Navigate to the **Configuration > Security > Authentication > Servers** page.
2. In the Servers list, select **Internal DB**.
3. Under **Users**, click **Add User** to add users.
4. For each user, enter a username and password.
5. Select the **Role** for each user (if a role is not specified, the default role is **guest**).
6. Select the expiration time for the user account in the internal database.
7. Click **Apply**.

In the CLI



NOTE: Use the privileged mode in the CLI to configure users in the controller's internal database.

```
(host) (config) #local-userdb add username <user> password <password>
```

Configuring a Server Rule Using the WebUI

1. Navigate to the **Configuration > Security > Authentication > Servers** page.
2. Select **Server Group** to display the Server Group list.
3. Select the **internal** server group.
4. Under **Server Rules**, click **New** to add a server derivation rule.
 - a. For **Condition**, enter **Role**.
 - b. Select **value-of** from the drop-down menu.
 - c. Select **Set Role** from the drop-down menu.
 - d. Click **Add**.
5. Click **Apply**.

Configuring a Server Rule Using the CLI

```
(host) (config) #aaa server-group internal
    set role condition Role value-of
```

Configuring 802.1x Authentication

An AAA profile specifies the 802.1x authentication profile and 802.1x server group to be used for authenticating clients for a WLAN. The AAA profile also specifies the default user role for 802.1x authentication.

For this example, you enable both 802.1x authentication and termination on the controller.

In the WebUI

1. Navigate to the **Configuration > Security > Authentication > L2 Authentication** page. In the profiles list, select 802.1x Authentication Profile.
 - a. In the Instance list, enter **dot1x**, then click **Add**.
 - b. Select the dot1x profile you just created.
 - c. Select **Termination**.



NOTE: The defaults for EAP Method and Inner EAP Method are EAP-PEAP and EAP-MSCHAPv2, respectively.

- d. Click **Apply**.
2. Select the **AAA Profiles** tab.
 - a. In the AAA Profiles Summary, click **Add** to add a new profile.
 - b. Enter **aaa_dot1x**, then click **Add**.
 - c. Select the **aaa_dot1x** profile you just created.
 - d. For 802.1x Authentication Default Role, select **faculty**.
 - e. Click **Apply**.
 3. In the Profiles list (under the **aaa_dot1x** profile you just created), select 802.1x Authentication Profile.
 - a. Select the dot1x profile from the 802.1x Authentication Profile drop-down menu.
 - b. Click **Apply**.
 4. In the Profiles list (under the **aaa_dot1x** profile you just created), select 802.1x Authentication Server Group.
 - a. Select the **internal** server group.
 - b. Click **Apply**.

In the CLI

```
(host)(config) #aaa authentication dot1x dot1x
termination enable
```

```
(host)(config) #aaa profile aaa_dot1x
d>ot1x-default-role student
authentication-dot1x dot1x
d>ot1x-server-group internal
```

Configuring VLANs

In this example, wireless clients are assigned to either VLAN 60 or 61 while guest users are assigned to VLAN 63. VLANs 60 and 61 split users into smaller IP subnetworks, improving performance by decreasing broadcast traffic. The VLANs are internal to the Dell controller only and do not extend into other parts of the wired network. The clients' default gateway is the Dell controller, which routes traffic out to the 10.1.1.0 subnetwork.

You configure the VLANs, assign IP addresses to each VLAN, and establish the "helper address" to which client DHCP requests are forwarded.

In the WebUI

1. Navigate to the **Configuration > Network > VLAN** page. Click **Add** to add VLAN 60.
 - a. For VLAN ID, enter **60**.
 - b. Click **Apply**.
 - c. Repeat steps A and B to add VLANs 61 and 63.
2. To configure IP parameters for the VLANs, navigate to the **Configuration > Network > IP > IP Interfaces** page.
 - a. Click **Edit** for VLAN 60.
 - b. For IP Address, enter **10.1.60.1**.
 - c. For Net Mask, enter **255.255.255.0**.
 - d. Under DHCP Helper Address, click **Add**. Enter **10.1.1.25** and click **Add**.
 - e. Click **Apply**.
3. In the IP Interfaces page, click **Edit** for VLAN 61.
 - a. For IP Address, enter **10.1.61.1**.
 - b. For Net Mask, enter **255.255.255.0**.
 - c. Under DHCP Helper Address, click **Add**. Enter **10.1.1.25** and click **Add**.
 - d. Click **Apply**.
4. In the IP Interfaces page, click **Edit** for VLAN 63.
 - a. For IP Address, enter **10.1.63.1**.
 - b. For Net Mask, enter **255.255.255.0**.
 - c. Under DHCP Helper Address, click **Add**. Enter **10.1.1.25** and click **Add**.
 - d. Click **Apply**.
5. Select the **IP Routes** tab.
 - a. For Default Gateway, enter **10.1.1.254**.
 - b. Click **Apply**.

In the CLI

```
(host) (config) #vlan 60
(host) (config) #interface vlan 60
  ip address 10.1.60.1 255.255.255.0
  ip helper-address 10.1.1.25

(host) (config) #vlan 61
(host) (config) #interface vlan 61
  ip address 10.1.61.1 255.255.255.0
  ip helper-address 10.1.1.25

(host) (config) #vlan 63
(host) (config) #interface vlan 63
  ip address 10.1.63.1 255.255.255.0
  ip helper-address 10.1.1.25

(host) (config) #ip default-gateway 10.1.1.254
```

Configuring WLANs

In this example, default AP parameters for the entire network are as follows: the default ESSID is WLAN-01 and the encryption mode is TKIP. A second ESSID called “guest” has the encryption mode set to static WEP with a

configured WEP key.

In this example, the non-guest clients that associate to an AP are mapped into one of two different user VLANs. The initial AP to which the client associates determines the VLAN: clients that associate to APs in the first floor of the building are mapped to VLAN 60 and clients that associate to APs in the second floor of the building are mapped to VLAN 61. Therefore, the APs in the network are segregated into two AP groups, named “first-floor” and “second-floor”. (See ["Creating an AP group " on page 395](#) for information about creating AP groups.) The guest clients are mapped into VLAN 63.

Configuring the Guest WLAN

You create and configure the virtual AP profile “guest” and apply the profile to each AP group. The “guest” virtual AP profile contains the SSID profile “guest” which configures static WEP with a WEP key.

In the WebUI

1. Navigate to the **Configuration > Wireless > AP Configuration** page.
2. In the AP Group list, select first-floor.
3. In the Profiles list, select Wireless LAN then select Virtual AP.
4. To configure the guest virtual AP:
 - a. Select NEW from the Add a profile drop-down menu. Enter **guest** for the name of the virtual AP profile, and click **Add**.
 - b. In the Profile Details entry for the guest virtual AP profile, select NEW from the SSID profile drop-down menu. A pop-up window allows you to configure the SSID profile.
 - c. Enter **guest** for the name of the SSID profile.
 - d. Enter **guest** for the Network Name.
 - e. For Network Authentication, select **None**.
 - f. For Encryption, select **WEP**.
 - g. Enter the WEP key.
 - h. Click **Apply**.
 - i. Under Profile Details, click **Apply**.
5. Click on the guest virtual AP name in the Profiles list or in Profile Details to display configuration parameters.
 - a. Make sure Virtual AP enable is selected.
 - b. For VLAN, select **63**.
 - c. Click **Apply**.
6. Navigate to the **Configuration > Wireless > AP Configuration** page.
7. In the AP Group list, select second-floor.
8. In the Profiles list, select Wireless LAN, then select Virtual AP.
9. Select **guest** from the Add a profile drop-down menu. Click **Add**.
10. Click **Apply**.

In the CLI

```
(host) (config) #wlan ssid-profile guest
    essid guest
    wepkey1 aaaaaaaaaa
    opmode static-wep
```

```
(host) (config) #wlan virtual-ap guest
    vlan 63
```

```
ssid-profile guest

(host)(config) #ap-group first-floor
virtual-ap guest
(host)(config) #ap-group second-floor
virtual-ap guest
```

Configuring the Non-Guest WLANs

You create and configure the SSID profile “WLAN-01” with the ESSID “WLAN-01” and WPA TKIP encryption. You need to create and configure two virtual AP profiles: one with VLAN 60 for the first-floor AP group and the other with VLAN 61 for the second-floor AP group. Each virtual AP profile references the SSID profile “WLAN-01” and the previously-configured AAA profile “aaa_dot1x”.

In the WebUI

1. Navigate to the **Configuration > Wireless > AP Configuration** page.
2. In the AP Group list, select first-floor.
3. In the Profiles list, select Wireless LAN, then select Virtual AP.
4. To configure the WLAN-01_first-floor virtual AP:
 - a. Select **NEW** from the Add a profile drop-down menu. Enter **WLAN-01_first-floor**, and click **Add**.
 - b. In the Profile Details entry for the WLAN-01_first-floor virtual AP profile, select **aaa_dot1x** from the AAA Profile drop-down menu. A pop-up window displays the configured AAA parameters. Click **Apply** in the pop-up window.
 - c. From the SSID profile drop-down menu, select **NEW**. A pop-up window allows you to configure the SSID profile.
 - d. Enter **WLAN-01** for the name of the SSID profile.
 - e. Enter **WLAN-01** for the Network Name.
 - f. Select **WPA** for Network Authentication.
 - g. Click **Apply** in the pop-up window.
 - h. At the bottom of the Profile Details page, click **Apply**.
5. Click on the WLAN-01_first-floor virtual AP profile name in the Profiles list or in Profile Details to display configuration parameters.
 - a. Make sure Virtual AP enable is selected.
 - b. For VLAN, select 60.
 - c. Click **Apply**.
6. Navigate to the **Configuration > Wireless > AP Configuration** page.
7. In the AP Group list, select second-floor.
8. In the Profiles list, select Wireless LAN then select Virtual AP.
9. To create the WLAN-01_second-floor virtual AP:
 - a. Select **NEW** from the Add a profile drop-down menu. Enter **WLAN-01_second-floor**, and click **Add**.
 - b. In the Profile Details entry for the virtual AP profile, select **aaa_dot1x** from the AAA Profile drop-down menu. A pop-up window displays the configured AAA profile parameters. Click **Apply** in the pop-up window.
 - c. From the SSID profile drop-down menu, select **WLAN-01**. a pop-up window displays the configured SSID profile parameters. Click **Apply** in the pop-up window.
 - d. At the bottom of the Profile Details page, click **Apply**.

10. Click on the WLAN-01_second-floor virtual AP profile name in the Profiles list or in Profile Details to display configuration parameters.
 - a. Make sure Virtual AP enable is selected.
 - b. For VLAN, select 61.
 - c. Click Apply.

In the CLI

```
(host)(config) #wlan ssid-profile WLAN-01
    essid WLAN-01
    opmode wpa-tkip

(host)(config) #wlan virtual-ap WLAN-01_first-floor
    vlan 60
    aaa-profile aaa_dot1x
    ssid-profile WLAN-01

(host)(config) #wlan virtual-ap WLAN-01_second-floor
    vlan 61
    aaa-profile aaa_dot1x
    sid-profile WLAN-01

(host)(config) #ap-group first-floor
    virtual-ap WLAN-01_first-floor
(host)(config) #ap-group second-floor
    virtual-ap WLAN-01_second-floor
```

Configuring Mixed Authentication Modes

Use `12-auth-fail-through` command to perform mixed authentication which includes both MAC and 802.1x authentication. When MAC authentication fails, enable the `12-auth-fail-through` command to perform 802.1x authentication.



NOTE: By default the `12-auth-fail-through` command is disabled.

Table 64: *Mixed Authentication Modes*

Authentication	1	2	3	4	5	6
MAC authentication	Success	Success	Success	Fail	Fail	Fail
802.1x authentication	Success	Fail	—	Success	Fail	—
Association	dynamic-wep	No Association	static-wep	dynamic-wep	No Association	static-wep
Role Assignment	802.1x	—	MAC	802.1x	—	logon

Table 64 describes the different authentication possibilities

In the CLI

```
(host)(config) #aaa profile test
    12-auth-fail-through
```

Performing Advanced Configuration Options for 802.1X

This section describes advanced configuration options for 802.1X authentication.

Configuring Reauthentication with Unicast Key Rotation

When enabled, unicast and multicast keys are updated after each reauthorization. It is a best practice to configure the time intervals for reauthentication, multicast key rotation, and unicast key rotation to be at least 15 minutes. Make sure these intervals are mutually prime, and the factor of the unicast key rotation interval and the multicast key rotation interval is less than the reauthentication interval.



NOTE: Unicast key rotation depends upon both the AP/controller and wireless client behavior. It is known that some wireless NICs have issues with unicast key rotation.

The following is an example of the parameters you can configure for reauthentication with unicast and multicast key rotation:

- Reauthentication: Enabled
- Reauthentication Time Interval: 6011 Seconds
- Multicast Key Rotation: Enabled
- Multicast Key Rotation Time Interval: 1867 Seconds
- Unicast Key Rotation: Enabled
- Unicast Key Rotation Time Interval: 1021 Seconds

In the WebUI

1. Navigate to the **Configuration > Security > Authentication > L2 Authentication** page.
2. Select 802.1x Authentication Profile, then select the name of the profile you want to configure.
3. Select the **Advanced** tab. Enter the following values:
 - Reauthentication Interval: 6011
 - Multicast Key Rotation Time Interval: 1867
 - Unicast Key Rotation Time Interval: 1021
 - Multicast Key Rotation: (select)
 - Unicast Key Rotation: (select)
 - Reauthentication: (select)
4. Click **Apply**.

In the CLI

```
(host)(config) #aaa authentication dot1x profile
reauthentication
timer reauth-period 6011
unicast-keyrotation
timer ukey-rotation-period 1021
multicast-keyrotation
timer mkey-rotation-period 1867
```

Stateful and WISPr Authentication

ArubaOS supports stateful 802.1x authentication, stateful NTLM authentication and authentication for Wireless Internet Service Provider roaming (WISPr). Stateful authentication differs from 802.1X authentication in that the controller does not manage the authentication process directly, but monitors the authentication messages between a user and an external authentication server, and then assigns a role to that user based upon the information in those authentication messages. WISPr authentication allows clients to roam between hotspots using different ISPs.

This chapter describes the following topics:

- ["Working With Stateful Authentication" on page 221](#)
- ["Working With WISPr Authentication" on page 222](#)
- ["Understanding Stateful Authentication Best Practices" on page 222](#)
- ["Configuring Stateful 802.1x Authentication" on page 222](#)
- ["Configuring Stateful NTLM Authentication" on page 223](#)
- ["Configuring Stateful Kerberos Authentication" on page 224](#)
- ["Configuring WISPr Authentication" on page 225](#)

Working With Stateful Authentication

ArubaOS supports two different types of stateful authentication, stateful 802.1x and stateful NTLM.

- **Stateful 802.1x authentication:** This feature allows the controller to learn the identity and role of a user connected to a third-party AP, and is useful for authenticating users to networks with APs from multiple vendors. When an 802.1x-capable access point sends a authentication request to a RADIUS server, the controller inspects this request and the associated response to learn the authentication state of the user. It then applies an identity-based user role through the Policy Enforcement Firewall.
- **Stateful Kerberos authentication:** Use stateful Kerberos authentication to configure a controller to monitor the Kerberos authentication messages between a client and a Windows authentication server. If the client successfully authenticates via an Kerberos authentication server, the controller can recognize that the client has been authenticated and assign that client a specified user role.
- **Stateful NTLM authentication:** NT LAN Manager (NTLM) is a suite of Microsoft authentication and session security protocols. You can use stateful NTLM authentication to configure a controller to monitor the NTLM authentication messages between a client and a Windows authentication server. If the client successfully authenticates via an NTLM authentication server, the controller can recognize that the client has been authenticated and assign that client a specified user role.

The default Windows authentication method changed from the older NTLM protocol to the newer Kerberos protocol, starting with Windows 2000. Therefore, stateful NTLM authentication is most useful for networks with legacy, pre-Windows 2000 clients. Note also that unlike other types of authentication, all users authenticated via stateful NTLM authentication must be assigned to the user role specified in the Stateful NTLM Authentication

profile. Dell's stateful NTLM authentication does not support placing users in various roles based upon group membership or other role-derivation attributes.

Working With WISPr Authentication

WISPr authentication allows a "smart client" to authenticate on the network when they roam between Wireless Internet Service Providers, even if the wireless hotspot uses an ISP for which the client may not have an account.

If you are a hotspot operator using WISPr authentication, and a client that has an account with your ISP attempts to access the Internet at your hotspot, then your ISP's WISPr AAA server authenticates that client directly, and allows the client access on the network. If, however, the client only has an account with a *partner* ISP, then your ISP's WISPr AAA server forwards that client's credentials to the partner ISP's WISPr AAA server for authentication. Once the client has been authenticated on the partner ISP, it is authenticated on your hotspot's own ISP, as per their service agreements. After your ISP sends an authentication message to the controller, the controller assigns the default WISPr user role to that client.

ArubaOS supports the following smart clients, which enable client authentication and roaming between hotspots by embedding iPass Generic Interface Specification (GIS) *redirect*, *proxy*, *authentication* and *logoff* messages within HTML messages to the controller.

- iPass
- Bongo
- Trustive
- weRoam
- AT&T

Understanding Stateful Authentication Best Practices

Before you can configure a stateful authentication feature, you should have defined a user role you want to assign to the authenticated users, and created a server group that includes a RADIUS authentication server for stateful 802.1x authentication or a Windows server for stateful NTLM authentication. For details on performing these tasks, see the following sections of this User Guide:

- ["Roles and Policies" on page 296](#)
- ["Configuring a RADIUS Server" on page 169](#)
- ["Configuring a Windows Server" on page 174](#)
- ["Configuring Server Groups" on page 177](#)

You can use the default stateful NTLM authentication and WISPr authentication profiles to manage the settings for these features, or you can create additional profiles as desired. Note, however, that unlike most other types of authentication, stateful 802.1x authentication uses only a single Stateful 802.1x profile. This profile can be enabled or disabled, but you can not configure more than one instance of a Stateful 802.1x profile.

Configuring Stateful 802.1x Authentication

When you configure 802.1x authentication for clients on non-Dell APs, you must specify the group of RADIUS servers that performs the user authentication, and select the role to be assigned to those users who successfully complete authentication. When the user logs off or shuts down the client machine, ArubaOS sends the deauthentication message from the RADIUS server, and changes the user's role from the specified authenticated role back to the logon role. For details on defining a RADIUS server used for stateful 802.1x authentication, see ["Configuring a RADIUS Server" on page 169](#)

In the WebUI

To configure the Stateful 802.1x Authentication profile via the WebUI:

1. Navigate to the **Configuration > Security > Authentication > L2 Authentication** window.
2. In the Profiles list, select **Stateful 802.1x Authentication Profile**.
3. Click the **Default Role** drop-down list, and select the role assigned to stateful 802.1x authenticated users.
4. Specify the timeout period for authentication requests, from 1-20 seconds. The default value is 10 seconds.
5. Select the **Mode** checkbox to enable stateful 802.1x authentication.

In the CLI

Use the following commands to configure stateful 802.1x authentication via the command-line interface. The first set of commands defines the RADIUS server used for 802.1x authentication, and the second set assigns that server to a server group. The third set of commands associates that server group with the stateful 802.1x authentication profile, then sets the authentication role and timeout period.

```
(host) (config) # aaa authentication-server radius <server-name>
  acctport <port>
  authport <port>
  clone <server>
  enable
  host <ipaddr>
  key <psk>
  nas-identifier <string>
  nas-ip <ipaddr>
  retransmit <number>
  timeout <seconds>
  use-md5
  !

(host) (config) # aaa server-group group <server-group>
  auth-server <server-name>
  !

(host) (config) # aaa authentication stateful-dot1x
  server-group <server-group>
  default-role <role>
  enable
  timeout <seconds>
```

Configuring Stateful NTLM Authentication

The Stateful NTLM Authentication profile requires that you specify a server group which includes the servers performing NTLM authentication, and the role to be assigned to users who are successfully authenticated. For details on defining a windows server used for NTLM authentication, see ["Configuring a Windows Server" on page 174](#).

When the user logs off or shuts down the client machine, the user remains in the authenticated role until the user ages out, that is, until the user has sent no traffic for the amount of time specified in the User Idle Timeout setting in the **Configuration > Security > Authentication > Advanced** page.

In the WebUI

To create and configure a new instance of a stateful NTLM authentication profile via the WebUI:

1. Navigate to the **Configuration > Security > Authentication > L3 Authentication** page.

2. In the **Profiles** list, expand the **Stateful NTLM Authentication Profile**.
3. To define settings for an *existing* profile, click that profile name in the profiles list.
To create and define settings for a *new* Stateful NTLM Authentication profile, select an existing profile, then click the **Save As** button in the right window pane. Enter a name for the new profile in the entry field. at the top of the right window pane.
4. Click the **Default Role** drop-down list, and select the role to be assigned to all users after they complete stateful NTLM authentication.
5. Specify the timeout period for authentication requests, from 1-20 seconds. The default value is 10 seconds.
6. Select the **Mode** checkbox to enable stateful NTLM authentication.
7. Click **Apply**.
8. In the **Profiles** list, select the **Server Group** entry below the Stateful NTLM Authentication profile.
9. Click the **Server Group** drop-down list and select the group of Windows servers you want to use for stateful NTLM authentication.
10. Click **Apply**.

In the CLI

Use the following commands to configure stateful NTLM authentication via the command-line interface. The first set of commands defines the Windows server used for NTLM authentication, the second set adds that server to a server group, and the third set of commands associates that server group with the stateful NTLM authentication profile then defines the profile settings.

```
(host) (config) # aaa authentication-server windows <windows_server_name>
    host <ipaddr>
    enable

    !

(host) (config) # aaa server-group group <server-group>
    auth-server <windows_server_name>
    !

(host) (config) # aaa authentication stateful-ntlm
    default-role <role>
    enable

    server-group <server-group>
    timeout <seconds>
```

Configuring Stateful Kerberos Authentication

The Stateful Kerberos Authentication profile requires that you specify a server group which includes the Kerberos servers and the role to be assigned to users who are successfully authenticated. For details on defining a windows server used for Kerberos authentication, see ["Configuring a Windows Server" on page 174](#).

When the user logs off or shuts down the client machine, the user remains in the authenticated role until the user ages out, that is, until the user has sent no traffic for the amount of time specified in the User Idle Timeout setting in the **Configuration > Security > Authentication > Advanced** page.

In the WebUI

To create and configure a new instance of a stateful Kerberos authentication profile via the WebUI:

1. Navigate to the **Configuration > Security > Authentication > L3 Authentication** page.

2. In the **Profiles** list, expand the **Stateful Kerberos Authentication Profile**.
3. To define settings for an *existing* profile, click that profile name in the profiles list.
To create and define settings for a *new* Stateful Kerberos Authentication profile, select an existing profile, then click the **Save As** button in the right window pane. Enter a name for the new profile in the entry field. at the top of the right window pane.
4. Click the **Default Role** drop-down list, and select the role to be assigned to all users after they complete stateful Kerberos authentication.
5. Specify the timeout period for authentication requests, from 1-20 seconds. The default value is 10 seconds.
6. Click **Apply**.
7. In the **Profiles** list, select the **Server Group** entry below the Stateful Kerberos Authentication profile.
8. Click the **Server Group** drop-down list and select the group of Windows servers you want to use for stateful Kerberos authentication.
9. Click **Apply**.

In the CLI

Use the following commands to configure stateful Kerberos authentication via the command-line interface. The first set of commands defines the server used for Kerberos authentication, the second set adds that server to a server group, and the third set of commands associates that server group with the stateful NTLM authentication profile then defines the profile settings.

```
(host) (config) # aaa authentication-server windows <windows_server_name>
  host <ipaddr>
  enable

  !

(host) (config) # aaa server-group group <server-group>
  auth-server <windows_server_name>
  !

(host) (config) # aaa authentication stateful-kerberos
  default-role <role>
  enable

  server-group <server-group>
  timeout <seconds>
```

Configuring WISPr Authentication

A WISPr authentication profile includes parameters to define RADIUS attributes, the default role for authenticated WISPr users, maximum numbers of authenticated failures and logon wait times. The WISPr-Location-ID sent from the controller to the WISPr RADIUS server is the concatenation of the ISO Country Code, E.164 Country Code, E.164 Area Code and SSID/Zone parameters configured in this profile

The parameters to define WISPr RADIUS attributes are specific to the RADIUS server your ISP uses for WISPr authentication; contact your ISP to determine these values. You can find a list of ISO and ITU country and area codes at the ISO and ITU websitesg (www.iso.org) and <http://www.itu.int>.)

In the WebUI

This section describes how to create and configure a new instance of a WISPr authentication profile in the WebUI.

1. Navigate to the **Configuration > Security > Authentication > L3 Authentication** page.

2. In the **Profiles** list, expand the **WISPr Authentication Profile**.
3. To define settings for an *existing* profile, click that profile name in the profiles list.
To create and define settings for a *new* WISPr Authentication profile, select an existing profile, then click the **Save As** button in the right window pane. Enter a name for the new profile in the entry field. at the top of the right window pane.
4. Define values for the following parameters

Table 65: WISPr Authentication Profile Parameters

Parameter	Description
Default Role	Default role assigned to users that complete WISPr authentication.
Logon wait minimum wait	If the controller's CPU utilization has surpassed the Logon wait CPU utilization threshold value , the Logon wait minimum wait parameter defines the minimum number of seconds a user has to wait to retry a login attempt. Range: 1–10 seconds. Default: 5 seconds.
Logon wait maximum wait	If the controller's CPU utilization has surpassed the Logon wait CPU utilization threshold value, the Logon wait maximum wait parameter defines the maximum number of seconds a user has to wait to retry a login attempt. Range: 1–10 seconds. Default: 10 seconds.
Logon wait CPU utilization threshold	Percentage of CPU utilization at which the maximum and minimum login wait times are enforced. Range: 1–100%. Default: 60%.
WISPr Location-ID ISO Country Code	The ISO Country Code section of the WISPr Location ID.
WISPr Location-ID E.164 Country Code	The E.164 Country Code section of the WISPr Location ID.
WISPr Location-ID E.164 Area Code	The E.164 Area Code section of the WISPr Location ID.
WISPr Location-ID SSID/Zone	The SSID/Zone section of the WISPr Location ID.
WISPr Operator Name	A name identifying the hotspot operator.
WISPr Location Name	A name identifying the hotspot location. If no name is defined, the parameter uses the name of the AP to which the user has associated.

5. Click **Apply**.
6. In the **Profiles** list, select the **Server Group** entry below the WISPr Authentication profile.
7. Click the **Server Group** drop-down list and select the group of RADIUS servers you want to use for WISPr authentication.
8. Click **Apply**.



NOTE: A Boingo smart client uses a NAS identifier in the format <CarrierID>_<VenueID> for location identification. To support Boingo clients, you must also configure the NAS identifier parameter in the Radius server profile for the WISPr server

In the CLI

Use the following CLI commands to configure WISPr authentication. The first set of commands defines the RADIUS server used for WISPr authentication, the second set adds that server to a server group, and the third set of commands associates that server group with the WISPr authentication profile then defines the profile settings.

```
(host) (config) # aaa authentication-server radius <rad_server_name>
host 172.4.77.214
```

```
key qwERTyuIOp
enable
nas-identifier corp_venue1
!

(host)(config)# aaa server-group group <server-group>
auth-server <radius_server_name>
!

(host)(config)# aaa authentication wispr
default-role <role>
logon-wait {cpu-threshold|maximum-delay|minimum-delay}
server-group <server-group>
wispr-location-id-ac <wispr-location-id-ac>
wispr-location-id-cc <wispr-location-id-cc>
wispr-location-id-isocc <wispr-location-id-isocc>
wispr-location-id-network <wispr-location-id-network>
wispr-location-name-location <wispr-location-name-location>
wispr-location-name-operator-name <wispr-location-name-location>
```

Chapter 16

Certificate Revocation

The Certificate Revocation feature enables the ArubaOS controller to perform real-time certificate revocation checks using the Online Certificate Status Protocol (OCSP) or traditional certificate validation using the Certificate Revocation List (CRL) client.

Topics in this chapter include:

- ["Understanding OCSP and CRL" on page 228](#)
- ["Configuring the Controller as a CRL Client" on page 230](#)
- ["Configuring the Controller as an OCSP Responder " on page 231](#)
- ["Configuring the Controller as an OCSP Client" on page 229](#)

Understanding OCSP and CRL

OCSP (RFC 2560) is a standard protocol that consists of an OCSP client and an OCSP responder. This protocol determines revocation status of a given digital public-key certificate without having to download the entire CRL.

CRL is the traditional method of checking certificate validity. A CRL provides a list of certificate serial numbers that have been revoked or are no longer valid. CRLs let the verifier check the revocation status of the presented certificate while verifying it. CRLs are limited to 512 entries.

Configuring a Controller as OCSP and CRL Clients

The ArubaOS controller can act as an OCSP client and issues OCSP queries to remote OCSP responders located on the intranet or Internet. As many applications in ArubaOS (such as IKE), use digital certificates, a protocol such as OCSP needs to be implemented for revocation.

An entity that relies on the content of a certificate (a relying party) needs to do the checking before accepting the certificate as being valid. One check verifies that the certificate has not been revoked. The OCSP client retrieves certificate revocation status from an OCSP responder. The responder may be the CA (Certificate Authority) that has issued the certificate in question or it may be some other designated entity which provides the service on behalf of the CA. A *revocation checkpoint* is a logical profile that is tied to each CA certificate that the controller has (trusted or intermediate). Also, the user can specify revocation preferences within each profile.

The OCSP request is not signed by the Dell OCSP client at this time. However, the OCSP response is always signed by the responder.

Both OCSP and CRL configuration and administration is usually performed by the administrator who manages the web access policy for an organization.

In small networks where there are is no Internet connection or connection to an OCSP responder, CRL is better option than OCSP.

Configuring an OCSP Controller as a Responder

The ArubaOS controller can be configured to act as an OCSP responder (server) and respond to OCSP queries from clients that are trying to obtain revocation status of certificates.

The OCSP responder on the controller is accessible over HTTP port 8084. This port is not configurable by the administrator. Although the OCSP responder accepts signed OCSP requests, it does not attempt to verify the signature before processing the request. Therefore, even unsigned OCSP requests are supported.

The controller as an OCSP responder provides revocation status information to ArubaOS applications that are using CRLs. This is useful in small disconnected networks where clients cannot reach outside OCSP server to validate certificates. Typical scenarios include client to client or client to other server communication situations where the certificates of either party need to be validated.

Configuring the Controller as an OCSP Client

When OCSP is used as the revocation method, you need to configure the OCSP responder certificate and the OCSP URL.

In the WebUI

1. Navigate to the **Configuration > Management > Certificates > Upload** page.
2. Enter a name in the **Certificate Name** field. This name identifies the certificate you are uploading.
3. Enter the certificate file name in the **Certificate Filename** field. Use the **Browse** button to enter the full pathname.
4. Select the certificate format from the **Certificate Format** drop-down menu.
5. Select **OCSP Responder Cert** from the **Certificate Type** drop-down menu.



NOTE: A revocation check method (OCSP or CRL) can be chosen independently for every revocation checkpoint. In this example, we are only describing the OCSP check method.

Once this certificate is uploaded it is maintained in the certificate store for OCSP responder certificates. These certificates are used for signature verification.

Figure 66: Upload a certificate

Management > Certificates > Upload

Upload | CSR | Revocation CheckPoint

Upload a Certificate

Certificate Name:

Certificate Filename:

Passphrase (optional): For import purpose only, will not be stored in the system.

Retype Passphrase:

Certificate Format:

Certificate Type:

Certificate Lists

Group By:

Name	Type	Filename	Reference	Expired	Actions
ocspresp-march25	OCSPResponderCert	OCSPrespondercert-March25.cer	0	No	<input type="button" value="View"/> <input type="button" value="Delete"/>
rootca-ocspresp-feb16	OCSPResponderCert	OCSPrespondercertFeb16.cer	0	No	<input type="button" value="View"/> <input type="button" value="Delete"/>
rootocspres-apr14	OCSPResponderCert	root-ocsprespApr14.cer	1	No	<input type="button" value="View"/> <input type="button" value="Delete"/>
rootocspresp-apr10	OCSPResponderCert	root-ocsprespApr10.cer	0	No	<input type="button" value="View"/> <input type="button" value="Delete"/>
rootocspresp-apr10-new	OCSPResponderCert	root-ocsprespApr10.cer	0	No	<input type="button" value="View"/> <input type="button" value="Delete"/>
subsubca-ocsp-feb17	OCSPResponderCert	subsubCA-OCSPresp-feb17.cer	0	No	<input type="button" value="View"/> <input type="button" value="Delete"/>
subsubca-ocspresp-apr15	OCSPResponderCert	subsubCA-OCSPresp-Apr15.cer	1	No	<input type="button" value="View"/> <input type="button" value="Delete"/>
subsubca-ocspresp-march24	OCSPResponderCert	subsubCA-OCSPresp-March24.cer	0	No	<input type="button" value="View"/> <input type="button" value="Delete"/>
subsubca-ocspresp3	OCSPResponderCert	subsubca-ocspresp-3.cer	1	No	<input type="button" value="View"/> <input type="button" value="Delete"/>
SubSubCA-ocsprespApr7	OCSPResponderCert	subsubCA-OCSPresp-Apr7.cer	0	No	<input type="button" value="View"/> <input type="button" value="Delete"/>
subsubca-ocspresponder	OCSPResponderCert	subsubCA-OCSPrespcert.cer	0	No	<input type="button" value="View"/> <input type="button" value="Delete"/>

6. Click **Upload**. The certificate appears in the Certificate Lists pane.
7. For detailed information about an uploaded certificate, click **View** next to the certificate.

Figure 67: View certificate details

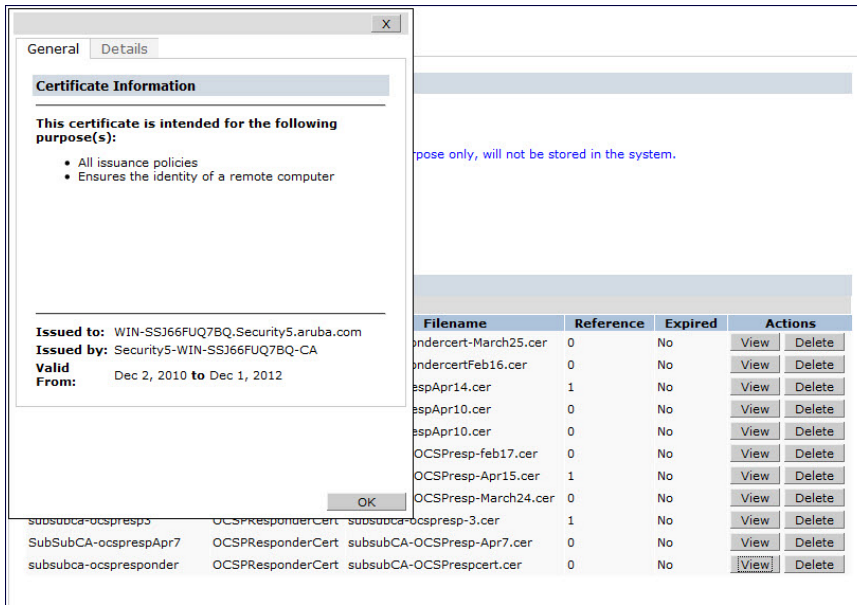

8. Select the **Revocation Checkpoint** tab.
9. In the **Revocation Checkpoint** pane, click **Edit** next to the revocation checkpoint that you want to configure. The **Revocation Checkpoint** pane displays.
10. In the **Revocation Check** field, select **ocsp** from the **Method 1** drop-down list as the primary check method.
11. In the **OCSP URL** field, enter the URL of the OCSP responder.
12. In the **OCSP Responder Cert** field, select the OCSP certificate you want to configure from the drop-down menu.
13. Click **Apply**.

In the CLI

This example configures an OCSP client with the revocation check method as OCSP for revocation check point CARoot.

The OCSP responder certificate is configured as RootCA-Ocsp_responder. The corresponding OCSP responder service is available at <http://10.4.46.202/ocsp>. The check method is OCSP for revocation check point CARoot.

```
(host) (config) #crypto-local pki rcp CARoot
(host) (RCP-CARoot) #ocsp-responder-cert RootCA-Ocsp_responder
(host) (RCP-CARoot) #ocsp-url http://10.4.46.202/ocsp
(host) (RCP-CARoot) #revocation-check ocsp
```

The `show crypto-local pki OCSResponderCert` CLI command lists the contents of the OCSP Responder Certificate store.

The `show crypto-local pki revocation checkpoint rcp_name` CLI command shows the entire configuration for a given revocation checkpoint.

Configuring the Controller as a CRL Client

CRL is the traditional method of checking certificate validity. When you want to check certificate validity using a CRL, you need to import the CRL. CRLs can only be imported using the WebUI.

In the WebUI

1. Navigate to the **Configuration > Management > Certificates > Upload** page.
2. Enter a name in the **Certificate Name** field. This name identifies the CRL certificate you are uploading.
3. Enter the certificate file name in the **Certificate Filename** field. Use the **Browse** button to enter the full pathname.
4. Select the certificate format from the **Certificate Format** drop-down menu.
5. Select **CRL** from the **Certificate Type** drop-down menu.



NOTE: A revocation check method (OCSP or CRL) can be chosen independently for every revocation checkpoint. In this example, we are only describing the CRL check method.

Once this CRL is uploaded it is maintained in the store for CRLs. These CRLs are used for signature verification.

6. Click **Upload**. The CRL appears in the Certificate Lists pane. Select **CRL** from the **Group** drop-down list if you want to display only CRLs.
7. For detailed information about an uploaded CRL, click **View** next to the CRL.
8. Select the **Revocation Checkpoint** tab.
9. In the **Revocation Checkpoint** pane, click **Edit** next to the revocation checkpoint that you want to configure. The **Revocation Checkpoint** pane displays.
10. In the **Revocation Check** field, select **crl** from the Method 1 drop-down list.
11. In the **CRL Location** field, enter the CRL you want used for this revocation checkpoint. The CRLs listed are files that have already been imported onto the controller.
12. Click **Apply**.

In the CLI

This example configures an OCSP responder with the check method as CRL for revocation check point ROOTCa-ssh-webui. The CRL location is crl1 and the revocation check method is crl.

```
(host) (config) #crypto-local pki rcp ROOTCa-ssh-webui
(host) (RCP-CARoot) #crl-location file crl1
(host) (RCP-CARoot) #revocation-check crl
```

Configuring the Controller as an OCSP Responder

When configured as an OCSP responder, the controller provides revocation status information to ArubaOS applications that are using CRLs.

In the WebUI

1. Navigate to the **Configuration > Management > Certificates > Upload** page.
2. Enter a name in the **Certificate Name** field. This name identifies the OCSP signer certificate you are uploading.
3. Enter the certificate file name in the **Certificate Filename** field. Use the **Browse** button to enter the full pathname.
4. Select the certificate format from the **Certificate Format** drop-down menu.
5. Select **OCSP signer cert** from the **Certificate Type** drop-down menu. Once this certificate is uploaded it is maintained in the certificate store for OCSP signer certificates. These certificates are used for signature verification.

The OCSP signer cert is used to sign OCSP responses for this revocation check point. The OCSP signer cert can be the same trusted CA as the check point, a designated OCSP signer certificate issued by the same CA as the check point or some other local trusted authority.

If you do not specify an OCSP signer cert, OCSP responses are signed using the global OCSP signer certificate. If that is not present, than an error message is sent out to clients.



NOTE: The OCSP signer certificate takes precedence over the global OCSP signer certificate as this is check point specific

6. Click **Upload**. The certificate appears in the Certificate Lists pane. Select **OCSP signer cert** from the **Group** drop-down list if you want to display only those certificates which are OCSP signer certificates.
7. For detailed information about an uploaded certificate, click **View** next to the certificate.
8. Select the **Revocation Checkpoint** tab.
9. Select **Enable** next to **Enable OCSP Responder**.
Enable OCSP Responder is a global knob that turns the OCSP responder service on or off on the controller. The default is disabled (off). Enabling this knob automatically adds the OCSP responder port (TCP 8084) to the permit list in the CP firewall so this can be accessed from outside the controller.
10. Select the **OCSP signer cert** from the **OCSP Certificates** drop-down menu to be used to sign OCSP responses for this revocation check point.
11. In the **Revocation Checkpoint** pane, click **Edit** next to the revocation checkpoint that you want to configure. The **Revocation Checkpoint** pane displays.
12. In the **Revocation Check** field, optionally select a check method from the **Method 1** drop-down list. Optionally, select a backup check method from the **Method 2** drop-down list.
13. Select **Enable** next to **Enable OCSP Responder**.
14. Select the OCSP signer cert from the **OCSP Signer Cert** drop-down menu.
15. IN the **CRL Location** field, enter the CRL you want used for this revocation checkpoint. The CRLs listed are files that have already been imported onto the controller.
16. Click **Apply**.

In the CLI

This example configures the controller as an OCSP responder. The OCSP responder service is enabled, the revocation check point is CAroot, the OCSP signer cert is “oscap_CA1,” the CRL file location is “Secl-WIN-05PRGNGEKAO-CA-unrevoked.crl.”

```
(host) (config) #crypto-local pki service-ocsp-responder
(host) (config) #crypto-local pki rcp CAroot
      (host) (CAroot) #ocsp-signer-cert oscsp_CA1
      (host) (CAroot) #crl-location file Secl-WIN-05PRGNGEKAO-CA-unrevoked.crl
      (host) (CAroot) #enable-ocsp-responder
```

Chapter 17

Captive Portal Authentication

Captive portal is one of the methods of authentication supported by ArubaOS. A captive portal presents a web page which requires user action before network access is granted. The required action can be simply viewing and agreeing to an acceptable use policy, or entering a user ID and password which must be validated against a database of authorized users.

You can also configure captive portal to allow clients to download the Dell VPN dialer for Microsoft VPN clients if the VPN is to be terminated on the controller. For more information about the VPN dialer, see [Virtual Private Networks on page 271](#).

Topics in this chapter include:

- ["Understanding Captive Portal" on page 233](#)
- ["Configuring Captive Portal in the Base Operating System" on page 234](#)
- ["Using Captive Portal with a PEFNG License" on page 237](#)
- ["Sample Authentication with Captive Portal" on page 239](#)
- ["Configuring Guest VLANs" on page 245](#)
- ["Configuring Captive Portal Authentication Profiles" on page 246](#)
- ["Enabling Optional Captive Portal Configurations" on page 250](#)
- ["Personalizing the Captive Portal Page" on page 254](#)
- ["Creating and Installing an Internal Captive Portal" on page 256](#)
- ["Creating Walled Garden Access" on page 265](#)
- [Enabling Captive Portal Enhancements](#)

Understanding Captive Portal

You can configure captive portal for guest users, where no authentication is required, or for registered users who must be authenticated against an external server or the controller's internal database.



NOTE: While you can use captive portal to authenticate users, it does not provide for encryption of user data and should not be used in networks where data security is required. Captive portal is most often used for guest access, access to open systems (such as public hot spots), or as a way to connect to a VPN.

You can use captive portal for guest and registered users at the same time. The default captive portal web page provided with ArubaOS displays login prompts for both registered users and guests. (You can customize the default captive portal page, as described in ["Personalizing the Captive Portal Page" on page 254](#))

You can also load up to 16 different customized login pages into the controller. The login page displayed is based on the SSID to which the client associates.

Policy Enforcement Firewall Next Generation (PEFNG) License

You can use captive portal with or without the PEFNG license installed in the controller. The PEFNG license provides identity-based security to wired and wireless clients through user roles and firewall rules. You must purchase and install the PEFNG license on the controller to use identity-based security features.

There are differences in how captive portal functions work and how you configure captive portal, depending on whether the license is installed. Other parts of this *chapter* describe how to configure captive portal in the base operating system (without the PEFNG license) and with the license installed.

Controller Server Certificate

The Dell controller is designed to provide secure services through the use of digital certificates. A server certificate installed in the controller verifies the authenticity of the controller for captive portal.

Dell controllers ship with a demonstration digital certificate. Until you install a customer-specific server certificate in the controller, this demonstration certificate is used by default for all secure HTTP connections such as captive portal. This certificate is included primarily for the purposes of feature demonstration and convenience and is not intended for long-term use in production networks. Users in a production environment are urged to obtain and install a certificate issued for their site or domain by a well-known certificate authority (CA). You can generate a Certificate Signing Request (CSR) on the controller to submit to a CA. For information on how to generate a CSR and how to import the CA-signed certificate into the controller, see ["Managing Certificates" on page 635](#) in [Management Access on page 625](#).

Once you have imported a server certificate into the controller, you can select the certificate to be used with captive portal as described in the following sections.

To select a certificate for captive portal using the WebUI:

1. Navigate to the **Configuration > Management > General** page.
2. Under Captive Portal Certificate, select the name of the imported certificate from the drop-down list.
3. Click **Apply**.

To select a certificate for captive portal using the command-line interface, access the CLI in config mode and issue the following commands:

```
(host) (config) #web-server
    captive-portal-cert <certificate>
```

To specify a different server certificate for captive portal with the CLI, use the **no** command to revert back to the default certificate *before* you specify the new certificate:

```
(host) (config) #web-server
    captive-portal-cert ServerCert1
    no captive-portal-cert
    captive-portal-cert ServerCert2
```

Configuring Captive Portal in the Base Operating System

The base operating system (ArubaOS without any licenses) allows full network access to all users who connect to an ESSID, both guest and registered users. In the base operating system, you cannot configure or customize user roles; this function is only available by installing the PEFNG license. Captive portal allows you to control or identify who has access to network resources.

When you create a captive portal profile in the base operating system, an implicit user role is automatically created with same name as the captive portal profile. This implicit user role allows only DNS and DHCP traffic between the client and network and directs all HTTP or HTTPS requests to the captive portal. You cannot directly modify the

implicit user role or its rules. Upon authentication, captive portal clients are allowed full access to their assigned VLAN.



NOTE: The WLAN Wizard within the ArubaOS WebUI allows for basic captive portal configuration for WLANs associated with the “default” ap-group: **Configuration > Wizards > WLAN Wizard**. Follow the steps in the workflow pane within the wizard and refer to the help tab for assistance.

What follows are the tasks for configuring captive portal in the base ArubaOS. The example server group and profile names appear inside quotation marks.

- Create the Server Group name. In this example, the server group name is “cp-srv”.
If you are configuring captive portal for registered users, configure the server(s) and create the server group. For more information about configuring authentication servers and server groups, see [Authentication Servers on page 168](#).
- Create Captive Portal Authentication Profile. In this example, the profile name is “c-portal”.
Create and configure an instance of the captive portal authentication profile. Creating the captive portal profile automatically creates an implicit user role and ACL with the same name. Creating the profile “c-portal” creates an implicit user role called “c-portal”. That user role allows only DNS and DHCP traffic between the client and network and directs all HTTP or HTTPS requests to the captive portal.
- Create an AAA Profile. In this example, the profile name is “aaa_c-portal”.
Create and configure an instance of the AAA profile. For the initial role, enter the implicit user role that was created in [step on page 235](#). The initial role in the profile “aaa_c-portal” must be set to “c-portal”.
- Create SSID Profile. In this example, the profile name is “ssid_c-portal”.
Create and configure an instance of the virtual AP profile which you apply to an AP group or AP name. Specify the AAA profile you created in [step on page 235](#).
- Create a Virtual AP Profile. In this example, the profile name is “vp_c-portal”.
Create and configure an instance of the SSID profile for the virtual AP.

The following sections present the procedure for configuring the captive portal authentication profile, the AAA profile, and the virtual AP profile using the WebUI or the command line (CLI). Configuring the VLAN and authentication servers and server groups are described elsewhere in this document.



NOTE: In ArubaOS 2.5.2 and later 2.5.x releases, captive portal users in the base operating system are placed into the predefined *cpbase* initial user role before authentication. The *cpbase* role is not supported in ArubaOS 3.x. You need to create new captive portal profiles in the base operating system, as described in this section, which automatically generates the required policies and roles.

In the WebUI

1. Navigate to the **Configuration > Security > Authentication > L3 Authentication** page. Select Captive Portal Authentication Profile.
 - a. In the Captive Portal Authentication Profile Instance list, enter the name of the profile (for example, **c-portal**), then click **Add**.
 - b. Select the captive portal authentication profile you just created.
 - c. You can enable user login and/or guest login, and configure other captive portal profile parameters as described in [Table 68](#).
 - d. Click **Apply**.

2. To specify authentication servers, select Server Group under the captive portal authentication profile you just configured.
 - a. Select the server group (for example, **cp-srv**) from the drop-down menu.
 - b. Click **Apply**.
3. Select the **AAA Profiles** tab.
 - a. In the AAA Profiles Summary, click **Add** to add a new profile. Enter the name of the profile (for example, **aaa_c-portal**), then click **Add**.
 - b. Select the AAA profile you just created.
 - c. For Initial Role, select the captive portal authentication profile (for example, **c-portal**) you created previously.



NOTE: The Initial Role must be exactly the same as the name of the captive portal authentication profile you created.

- d. Click **Apply**.
4. Navigate to the **Configuration > Wireless > AP Configuration** page. Select either the AP Group or AP Specific tab. Click **Edit** for the applicable AP group name or AP name.
5. Under Profiles, select Wireless LAN, then select Virtual AP.
6. To create a new virtual AP profile, select **NEW** from the Add a profile drop-down menu. Enter the name for the virtual AP profile (for example, **vp_c-portal**), then click **Add**.
 - a. In the Profile Details entry for the new virtual AP profile, select the AAA profile you previously created from the AAA Profile drop-down menu. A pop-up window displays the configured AAA profile parameters. Click **Apply** in the pop-up window.
 - b. From the SSID profile drop-down menu, select **NEW**. A pop-up window allows to you configure the SSID profile.
 - c. Enter the name for the SSID profile (for example, **ssid_c-portal**).
 - d. Enter the Network Name for the SSID (for example, **c-portal-ap**).
 - e. Click **Apply** in the pop-up window.
 - f. At the bottom of the Profile Details page, click **Apply**.
7. Click on the new virtual AP name in the Profiles list or in Profile Details to display configuration parameters.
 - a. Make sure Virtual AP enable is selected.
 - b. For VLAN, select the VLAN to which users are assigned (for example, **20**).
 - c. Click **Apply**.

In the CLI

To configure captive portal in the base operating system via the command-line interface, access the CLI in config mode and issue the following commands:

```
(host)(config) #aaa authentication captive-portal c-portal
server-group cp-srv
(host)(config) #aaa profile aaa_c-portal
initial-role c-portal
(host)(config) #wlan ssid-profile ssid_c-portal
ssid c-portal-ap
(host)(config) #wlan virtual-ap vp_c-portal
aaa-profile aaa_c-portal
ssid-profile ssid_c-portal
vlan 20
```

Using Captive Portal with a PEFNG License

The PEFNG license provides identity-based security for wired and wireless users. There are two user roles that are important for captive portal:

- Default user role, which you specify in the captive portal authentication profile, is the role granted to clients upon captive portal authentication. This can be the predefined **guest** system role.
- Initial user role, which you specify in the AAA profile, directs clients who associate to the SSID to captive portal whenever the user initiates a Web browser connection. This can be the predefined **logon** system role.

The captive portal authentication profile specifies the captive portal login page and other configurable parameters. The initial user role configuration must include the applicable captive portal authentication profile instance.



NOTE: MAC-based authentication, if enabled on the controller, takes precedence over captive portal authentication.

The following are the basic tasks for configuring captive portal using role-based access provided by the Policy Enforcement Firewall software module. Note that you must install the PEFNG license before proceeding (see [Software Licenses on page 100](#)).

- Configure the user role for a default user.
Create and configure user roles and policies for guest or registered captive portal users. (See [Roles and Policies on page 296](#) for more information about configuring policies and user roles.)
- Create a server group.
If you are configuring captive portal for registered users, configure the server(s) and create the server group. (See [Authentication Servers on page 168](#) for more information about configuring authentication servers and server groups.)



NOTE: If you are using the controller's internal database for user authentication, use the predefined "Internal" server group. You need to configure entries in the internal database, as described in [Authentication Servers on page 168](#).

- Create the captive portal authentication profile.
Create and configure an instance of the captive portal authentication profile. Specify the default user role for captive portal users.
- Configure the initial user role.
Create and configure the initial user role for captive portal. You need to include the predefined **captiveportal** policy, which directs clients to the captive portal, in the initial user role configuration.
You also need to specify the captive portal authentication profile instance in the initial user role configuration. For example, if you are using the predefined **logon** system role for the initial role, you need to edit the role to specify the captive portal authentication profile instance.
- Create the AAA Profile.
Create and configure an instance of the AAA profile. Specify the initial user role.
- Create the SSID Profile "ssid_c-portal".
Create and configure an instance of the virtual AP profile that you apply to an AP group or AP name. Specify the AAA profile you just created.
- Create the Virtual AP Profile "vp_c-portal".
Create and configure an instance of the SSID profile for the virtual AP.

The following sections present the WebUI and Command Line (CLI) procedures for configuring the captive portal authentication profile, initial user role, the AAA profile, and the virtual AP profile. Other chapters within this document detail the configuration of the user roles and policies, authentication servers, and server groups.

Configuring Captive Portal in the WebUI

To configure captive portal with PEFNG license via the WebUI:

1. Navigate to the **Configuration > Security > Authentication > L3 Authentication** page.
2. Select **Captive Portal Authentication Profile**.
 - a. In the **Captive Portal Authentication Profile Instance** list, enter the name of the profile (for example, **c-portal**), then click **Add**.
 - b. Select the captive portal authentication profile you just created.
 - c. Select the default role (for example, **employee**) for captive portal users.
 - d. Enable guest login and/or user login, as well as other parameters (refer to [Table 68](#)).
 - e. Click **Apply**.
3. To specify the authentication servers, select **Server Group** under the captive portal authentication profile you just configured.
 - a. Select the server group (for example, **cp-srv**) from the drop-down menu.
 - b. Click **Apply**.
4. Select the **AAA Profiles** tab.
 - a. In the **AAA Profiles Summary**, click **Add** to add a new profile. Enter the name of the profile (for example, **aaa_c-portal**), then click **Add**.
 - b. Set the Initial role to a role that you will configure with the captive portal authentication profile.
 - c. Click **Apply**.
5. Navigate to the **Configuration > Security > Access Control** page to configure the initial user role to use captive portal authentication.
 - a. To edit the predefined logon role, select the **System Roles** tab, then click **Edit** for the logon role.
 - b. To configure a new role, first configure policy rules in the **Policies** tab, then select the **User Roles** tab to add a new user role and assign policies.
 - c. To specify the captive portal authentication profile, scroll down to the bottom of the page. Select the profile from the **Captive Portal Profile** drop-down menu, and click **Change**.
 - d. Click **Apply**.
6. Navigate to the **Configuration > Wireless > AP Configuration** page to configure the virtual AP profile.
7. Select either the **AP Group** or **AP Specific** tab. Click **Edit** for the applicable AP group name or AP name.
8. Under **Profiles**, select **Wireless LAN**, then select **Virtual AP**.
9. Select **NEW** from the **Add a profile** drop-down menu to create a new virtual AP profile. Enter the name for the virtual AP profile (for example, **vp_c-portal**), then click **Add**.
 - a. In the **Profile Details** entry for the new virtual AP profile, select the AAA profile you previously configured. A pop-up window displays the configured AAA profile parameters. Click **Apply** in the pop-up window.
 - b. From the **SSID profile** drop-down menu, select **NEW**. A pop-up window allows you to configure the SSID profile.
 - c. Enter the name for the SSID profile (for example, **ssid_c-portal**).
 - d. Enter the **Network Name** for the SSID (for example, **c-portal-ap**).
 - e. Click **Apply** in the pop-up window.
 - f. At the bottom of the **Profile Details** page, click **Apply**.

10. Click on the new virtual AP name in the Profiles list or in Profile Details to display configuration parameters.
 - a. Make sure Virtual AP enable is selected.
 - b. For VLAN, select the VLAN to which users are assigned (for example, 20).
 - c. Click Apply.

Configuring Captive Portal in the CLI

To configure captive portal with the PEFNG license via the command-line interface, access the CLI in config mode and issue the following commands:

```
(host)(config) #aaa authentication captive-portal c-portal
    d>default-role employee
    server-group cp-srv
(host)(config) #user-role logon
    captive-portal c-portal
(host)(config) #aaa profile aaa_c-portal
    initial-role logon
(host)(config) #wlan ssid-profile ssid_c-portal
    essid c-portal-ap
    vlan 20
(host)(config) #wlan virtual-ap vp_c-portal
    aaa-profile aaa_c-portal
    ssid-profile ssid_c-portal
```

Sample Authentication with Captive Portal

In the following example:

- Guest clients associate to the **guestnet** SSID which is an open wireless LAN. Guest clients are placed into VLAN 900 and assigned IP addresses by the controller's internal DHCP server. The user has no access to network resources beyond DHCP and DNS until they open a web browser and log in with a guest account using captive portal.
- Guest users are given a login and password from guest accounts created in the controller's internal database. The temporary guest accounts are created and administered by the site receptionist.
- Guest users must enter their assigned login and password into the captive portal login before they are given access to use web browsers (HTTP and HTTPS), POP3 email clients, and VPN clients (IPsec, PPTP, and L2TP) on the Internet and only during specified working hours. Guest users are prohibited from accessing internal networks and resources. All traffic to the Internet is source-NATed.



NOTE: This example assumes a Policy Enforcement Firewall Next Generation (PEFNG) license is installed in the controller.

In this example, you create two user roles:

- **guest-logon** is a user role assigned to any client who associates to the **guestnet** SSID. Normally, any client that associates to an SSID will be placed into the *logon* system role. The **guest-logon** user role is more restrictive than the *logon* role.
- **auth-guest** is a user role granted to clients who successfully authenticate via the captive portal.

Creating a Guest User Role

The **guest-logon** user role consists of the following ordered policies:

- **captiveportal** is a predefined policy that allows captive portal authentication.
- **guest-logon-access** is a policy that you create with the following rules:

- Allows DHCP exchanges between the user and the DHCP server during business hours while blocking other users from responding to DHCP requests.
- Allows ICMP exchanges between the user and the controller during business hours.
- **block-internal-access** is a policy that you create that denies user access to the internal networks.



NOTE: The **guest-logon** user role configuration needs to include the name of the captive portal authentication profile instance. You can modify the user role configuration after you create the captive portal authentication profile instance.

Creating an Auth-guest User Role

The **auth-guest** user role consists of the following ordered policies:

- **cplogout** is a predefined policy that allows captive portal logout.
- **guest-logon-access** is a policy that you create with the following rules:
 - Allows DHCP exchanges between the user and the DHCP server during business hours while blocking other users from responding to DHCP requests.
 - Allows DNS exchanges between the user and the public DNS server during business hours. Traffic is source-NATed using the IP interface of the controller for the VLAN.
- **block-internal-access** is a policy that you create that denies user access to the internal networks.
- **auth-guest-access** is a policy that you create with the following rules:
 - Allows DHCP exchanges between the user and the DHCP server during business hours while blocking other users from responding to DHCP requests.
 - Allows DNS exchanges between the user and the public DNS server during business hours. Traffic is source-NATed using the IP interface of the controller for the VLAN.
 - Allows HTTP/S traffic from the user during business hours. Traffic is source-NATed using the I interface of the controller for the VLAN.
- **drop-and-log** is a policy that you create that denies all traffic and logs the attempted network access.

Configuring Policies and Roles in the WebUI

Creating a Time Range

To create a time range via the WebUI:

1. Navigate to the **Configuration > Security > Access Control > Time Ranges** page to define the time range “working-hours”.
2. Click **Add**.
 - a. For Name, enter **working-hours**.
 - b. For Type, select **Periodic**.
 - c. Click **Add**.
 - d. For Start Day, click **Weekday**.
 - e. For Start Time, enter **07:30**.
 - f. For End Time, enter **17:00**.
 - g. Click **Done**.
3. Click **Apply**.

To create the **guest-logon-access** policy via the WebUI:

1. Navigate to the **Configuration > Security > Access Control > Policies** page.
2. Select **Add** to add the **guest-logon-access** policy.

3. For Policy Name, enter **guest-logon-access**.
4. For Policy Type, select **IPv4 Session**.
5. Under Rules, select **Add** to add rules for the policy.
 - a. Under Source, select **user**.
 - b. Under Destination, select **any**.
 - c. Under Service, select **udp**. Enter **68**.
 - d. Under Action, select **drop**.
 - e. Click **Add**.
6. Under Rules, click **Add**.
 - a. Under Source, select **any**.
 - b. Under Destination, select **any**.
 - c. Under Service, select **service**. Select **svc-dhcp**.
 - d. Under Action, select **permit**.
 - e. Under Time Range, select **working-hours**.
 - f. Click **Add**.

Creating Aliases

The following step defines an alias representing the public DNS server addresses. Once defined, you can use the alias for other rules and policies.

1. Navigate to the **Configuration > Security > Access Control > Policies** page.
2. Select **Add** to add the guest-logon-access policy.
3. For Policy Name, enter **guest-logon-access**.
4. For Policy Type, select **IPv4 Session**.
5. Under Rules, click **Add**.
 - a. Under Source, select **user**.
 - b. Under Destination, select **alias**.
 - c. Under the alias selection, click **New**. For Destination Name, enter “Public DNS”. Click **Add** to add a rule. For Rule Type, select **host**. For IP Address, enter 64.151.103.120. Click **Add**. For Rule Type, select **host**. For IP Address, enter 216.87.84.209. Click **Add**. Click **Apply**. The alias “Public DNS” appears in the Destination menu
 - d. Under Destination, select **Public DNS**.
 - e. Under Service, select **svc-dns**.
 - f. Under Action, select **src-nat**.
 - g. Under Time Range, select **working-hours**.
 - h. Click **Add**.
6. Click **Apply**.

Creating an Auth-Guest-Access Policy

To configure the auth-guest-access policy via the WebUI:

1. Navigate to the **Configuration > Security > Access Control > Policies** page.
2. Select **Add** to add the guest-logon-access policy.
3. For Policy Name, enter **auth-guest-access**.
4. For Policy Type, select **IPv4 Session**.

5. Under Rules, select **Add** to add rules for the policy.
 - a. Under Source, select **user**.
 - b. Under Destination, select **any**.
 - c. Under Service, select **udp**. Enter **68**.
 - d. Under Action, select **drop**.
 - e. Click **Add**.
6. Under Rules, click **Add**.
 - a. Under Source, select **any**.
 - b. Under Destination, select **any**.
 - c. Under Service, select **service**. Select **svc-dhcp**.
 - d. Under Action, select **permit**.
 - e. Under Time Range, select **working-hours**.
 - f. Click **Add**.
7. Under Rules, click **Add**.
 - a. Under Source, select **user**.
 - b. Under Destination, select **alias**. Select **Public DNS** from the drop-down menu.
 - c. Under Service, select **service**. Select **svc-dns**.
 - d. Under Action, select **src-nat**.
 - e. Under Time Range, select **working-hours**.
 - f. Click **Add**.
8. Under Rules, click **Add**.
 - a. Under Source, select **user**.
 - b. Under Destination, select **any**.
 - c. Under Service, select **service**. Select **svc-http**.
 - d. Under Action, select **src-nat**.
 - e. Under Time Range, select **working-hours**.
 - f. Click **Add**.
9. Under Rules, click **Add**.
 - a. Under Source, select **user**.
 - b. Under Destination, select **any**.
 - c. Under Service, select **service**. Select **svc-https**.
 - d. Under Action, select **src-nat**.
 - e. Under Time Range, select **working-hours**.
 - f. Click **Add**.
10. Click **Apply**.

Creating an Block-Internal-Access Policy

To create the block-internal-access policy via the WebUI:

1. Navigate to the **Configuration > Security > Access Control > Policies** page.
2. Select **Add** to add the block-internal-access policy.
3. For Policy Name, enter **block-internal-access**.
4. For Policy Type, select **IPv4 Session**.

5. Under Rules, select **Add** to add rules for the policy.
 - a. Under Source, select **user**.
 - b. Under Destination, select **alias**.



NOTE: The following step defines an alias representing all internal network addresses. Once defined, you can use the alias for other rules and policies.

- c. Under the alias selection, click **New**. For Destination Name, enter “Internal Network”. Click **Add** to add a rule. For Rule Type, select **network**. For IP Address, enter 10.0.0.0. For Network Mask/Range, enter 255.0.0.0. Click **Add** to add the network range. Repeat these steps to add the network ranges 172.16.0.0 255.255.0.0 and 192.168.0.0 255.255.0.0. Click **Apply**. The alias “Internal Network” appears in the Destination menu
 - d. Under Destination, select Internal Network.
 - e. Under Service, select **any**.
 - f. Under Action, select **drop**.
 - g. Click **Add**.
6. Click **Apply**.

Creating a Drop-and-Log Policy

To create the drop-and-log policy via the WebUI:

1. Navigate to the **Configuration > Security > Access Control > Policies** page.
2. Select **Add** to add the drop-and-log policy.
3. For Policy Name, enter **drop-and-log**.
4. For Policy Type, select **IPv4 Session**.
5. Under Rules, select **Add** to add rules for the policy.
 - a. Under Source, select **user**.
 - b. Under Destination, select **any**.
 - c. Under Service, select **any**.
 - d. Under Action, select **drop**.
 - e. Select **Log**.
 - f. Click **Add**.
6. Click **Apply**.

Creating a Guest Role

To create a guest role via the WebUI:

1. Navigate to the **Configuration > Security > Access Control > User Roles** page.
2. Click **Add**.
3. For Role Name, enter guest-logon.
4. Under Firewall Policies, click **Add**.
5. For Choose from Configured Policies, select captiveportal from the drop-down menu.
6. Click **Done**.
7. Under Firewall Policies, click **Add**.
8. For Choose from Configured Policies, select guest-logon-access from the drop-down menu.
9. Click **Done**.

10. Under Firewall Policies, click **Add**.
11. For Choose from Configured Policies, select block-internal-access from the drop-down menu.
12. Click **Done**.
13. Click **Apply**.

Creating an Auth-Guest Role

To create the guest-logon role via the WebUI:

1. Navigate to the **Configuration > Security > Access Control > User Roles** page.
2. Click **Add**.
3. For Role Name, enter auth-guest.
4. Under Firewall Policies, click **Add**.
5. For Choose from Configured Policies, select cplogout from the drop-down menu.
6. Click **Done**.
7. Under Firewall Policies, click **Add**.
8. For Choose from Configured Policies, select guest-logon-access from the drop-down menu.
9. Click **Done**.
10. Under Firewall Policies, click **Add**.
11. For Choose from Configured Policies, select block-internal-access from the drop-down menu.
12. Click **Done**.
13. Under Firewall Policies, click **Add**.
14. For Choose from Configured Policies, select auth-guest-access from the drop-down menu.
15. Click **Done**.
16. Under Firewall Policies, click **Add**.
17. For Choose from Configured Policies, select drop-and-log from the drop-down menu.
18. Click **Done**.
19. Click **Apply**.

Configuring Policies and Roles in the CLI

Defining a Time Range

To create a time range via the command-line interface, access the CLI in config mode and issue the following commands:

```
(host) (config) #time-range working-hours periodic
    weekday 07:30 to 17:00
```

Creating Aliases

To create aliases via the command-line interface, access the CLI in config mode and issue the following commands:

```
(host) (config) #netdestination "Internal Network"
network 10.0.0.0 255.0.0.0
network 172.16.0.0 255.255.0.0
    network 192.168.0.0 255.255.0.0
(host) (config) #netdestination "Public DNS"
    host 64.151.103.120
    host 216.87.84.209
```

Creating a Guest-Logon-Access Policy

To create a guest-logon-access policy via the command-line interface, access the CLI in config mode and issue the following commands:

```
(host)(config) #ip access-list session guest-logon-access
  user any udp 68 deny
  any any svc-dhcp permit time-range working-hours
  user alias "Public DNS" svc-dns src-nat time-range working-hours
```

Creating an Auth-Guest-Access Policy

To create an auth-guest-access policy via the command-line interface, access the CLI in config mode and issue the following commands:

```
(host)(config) #ip access-list session auth-guest-access
  user any udp 68 deny
  any any svc-dhcp permit time-range working-hours
  user alias "Public DNS" svc-dns src-nat time-range working-hours
  user any svc-http src-nat time-range working-hours
  user any svc-https src-nat time-range working-hours
```

Creating a Block-Internal-Access Policy

To create a block-internal-access policy via the command-line interface, access the CLI in config mode and issue the following commands:

```
(host)(config) #ip access-list session block-internal-access
  user alias "Internal Network" any deny
```

Creating a Drop-and-Log Policy

To create a drop-and-log policy via the command-line interface, access the CLI in config mode and issue the following commands:

```
(host)(config) #ip access-list session drop-and-log
  user any any deny log
```

Creating a Guest-Logon Role

To create a guest-logon-role via the command-line interface, access the CLI in config mode and issue the following commands:

```
(host)(config) #user-role guest-logon
  session-acl captiveportal position 1
  session-acl guest-logon-access position 2
  session-acl block-internal-access position 3
```

Creating an Auth-Guest Role

To create an auth-guest role via the command-line interface, access the CLI in config mode and issue the following commands:

```
(host)(config) #user-role auth-guest
  session-acl cplogout position 1
  session-acl guest-logon-access position 2
  session-acl block-internal-access position 3
  session-acl auth-guest-access position 4
  session-acl drop-and-log position 5
```

Configuring Guest VLANs

Guests using the WLAN are assigned to VLAN 900 and are given IP addresses via DHCP from the controller.

In the WebUI

1. Navigate to the **Configuration > Network > VLANs** page.
 - a. Click **Add**.
 - b. For VLAN ID, enter 900.
 - c. Click **Apply**.
2. Navigate to the **Configuration > Network > IP > IP Interfaces** page.
 - a. Click **Edit** for VLAN 900.
 - b. For IP Address, enter 192.168.200.20.
 - c. For Net Mask, enter 255.255.255.0.
 - d. Click **Apply**.
3. Click the **DHCP Server** tab.
 - a. Select **Enable DHCP Server**.
 - b. Click **Add** under Pool Configuration.
 - c. For Pool Name, enter **guestpool**.
 - d. For Default Router, enter 192.168.200.20.
 - e. For DNS Server, enter 64.151.103.120.
 - f. For Lease, enter 4 hours.
 - g. For Network, enter 192.168.200.0. For Netmask, enter 255.255.255.0.
 - h. Click **Done**.
4. Click **Apply**.

In the CLI

```
(host) (config) #vlan 900
(host) (config) #interface vlan 900
(host) (config) #ip address 192.168.200.20 255.255.255.0
(host) (config) #ip dhcp pool "guestpool"
(host) (config) #default-router 192.168.200.20
(host) (config) #dns-server 64.151.103.120
(host) (config) #lease 0 4 0
(host) (config) #network 192.168.200.0 255.255.255.0
```

Configuring Captive Portal Authentication Profiles

In this section, you create an instance of the captive portal authentication profile and the AAA profile. For the captive portal authentication profile, you specify the previously-created **auth-guest** user role as the default user role for authenticated captive portal clients and the authentication server group (“Internal”).

To configure captive portal authentication via the WebUI:

1. Navigate to the **Configuration > Security > Authentication > L3 Authentication** page. In the Profiles list, select **Captive Portal Authentication Profile**.
 - a. In the Captive Portal Authentication Profile Instance list, enter **guestnet** for the name of the profile, then click **Add**.
 - b. Select the captive portal authentication profile you just created.
 - c. For Default Role, select **auth-guest**.
 - d. Select **User Login**.
 - e. Deselect (uncheck) **Guest Login**.

- f. Click **Apply**.
2. Select **Server Group** under the **guestnet** captive portal authentication profile you just created.
 - a. Select **internal** from the Server Group drop-down menu.
 - b. Click **Apply**.

To configure captive portal authentication via the command-line interface, access the CLI in config mode and issue the following commands:

```
(host)(config) #aaa authentication captive-portal guestnet
d>default-role auth-guest
user-logon
no guest-logon
server-group internal
```

Modifying the Initial User Role

The captive portal authentication profile specifies the captive portal login page and other configurable parameters. The initial user role configuration must include the applicable captive portal authentication profile instance. Therefore, you need to modify the **guest-logon** user role configuration to include the **guestnet** captive portal authentication profile.

To modify the guest-logon role via the WebUI:

1. Navigate to the **Configuration > Security > Access Control > User Roles** page.
2. Select **Edit** for the guest-logon role.
3. Scroll down to the bottom of the page.
4. Select the captive portal authentication profile you just created from the Captive Portal Profile drop-down menu, and click **Change**.
5. Click **Apply**.

To modify the guest-logon role via the command-line interface, access the CLI in config mode and issue the following commands:

```
(host)(config) #user-role guest-logon
captive-portal guestnet
```

Configuring the AAA Profile

In this section, you configure the **guestnet** AAA profile, which specifies the previously-created **guest-logon** role as the initial role for clients who associate to the WLAN.

To configure the AAA profile via the WebUI:

1. Navigate to the **Configuration > Security > Authentication > AAA Profiles** page.
2. In the AAA Profiles Summary, click **Add** to add a new profile. Enter **guestnet** for the name of the profile, then click **Add**.
3. For Initial role, select guest-logon.
4. Click **Apply**.

To configure the AAA profile via the command-line interface, access the CLI in config mode and issue the following commands:

```
(host)(config) #aaa profile guestnet
initial-role guest-logon
```

Configuring the WLAN

In this section, you create the **guestnet** virtual AP profile for the WLAN. The **guestnet** virtual AP profile contains the SSID profile **guestnet** (which configures opensystem for the SSID) and the AAA profile **guestnet**.

To configure the guest WLAN via the WebUI:

1. Navigate to the **Configuration > Wireless > AP Configuration** page.
2. Select either AP Group or AP Specific tab. Click **Edit** for the AP group or AP name.
3. To configure the virtual AP profile, navigate to the **Configuration > Wireless > AP Configuration** page. Select either the AP Group or AP Specific tab. Click **Edit** for the applicable AP group name or AP name.
4. Under Profiles, select Wireless LAN, then select Virtual AP.
5. To create a new virtual AP profile, select NEW from the Add a profile drop-down menu. Enter the name for the virtual AP profile (for example, **guestnet**), and click **Add**.
 - a. In the Profile Details entry for the new virtual AP profile, select the AAA profile you previously configured. A pop-up window displays the configured AAA profile parameters. Click **Apply** in the pop-up window.
 - b. From the SSID profile drop-down menu, select NEW. A pop-up window allows you to configure the SSID profile.
 - c. Enter the name for the SSID profile (for example, **guestnet**).
 - d. Enter the Network Name for the SSID (for example, **guestnet**).
 - e. For Network Authentication, select None.
 - f. For Encryption, select Open.
 - g. Click **Apply** in the pop-up window.
 - h. At the bottom of the Profile Details page, click **Apply**.
6. Click on the new virtual AP name in the Profiles list or in Profile Details to display configuration parameters.
 - a. Make sure Virtual AP enable is selected.
 - b. For VLAN, select the ID of the VLAN in which captive portal users are placed (for example, VLAN 900).
 - c. Click **Apply**.

To configure the guest WLAN via the command-line interface, access the CLI in config mode and issue the following commands:

```
(host) (config) #wlan ssid-profile guestnet
    essid guestnet
    opmode opensystem
```

```
(host) (config) #aaa profile guestnet
    initial-role guest-logon
```

```
(host) (config) #wlan virtual-ap guestnet
    vlan 900
    aaa-profile guestnet
    ssid-profile guestnet
```

Managing User Accounts

Temporary user accounts are created in the internal database on the controller. You can create a user role which will allow a receptionist to create temporary user accounts. Guests can use the accounts to log into a captive portal login page to gain Internet access.

See "[Creating Guest Accounts](#)" on page 650 for more information about configuring guest provisioning users and administering guest accounts.

Configuring Captive Portal Configuration Parameters

Table 68 describes configuration parameters on the WebUI Captive Portal Authentication profile page.



NOTE: In the CLI, you configure these options with the **aaa authentication captive-portal** commands.

Table 68: *Captive Portal Authentication Profile Parameters*

Parameter	Description
Black List	Name of an existing black list on an IPv4 or IPv6 network destination. The black list contains websites (unauthenticated) that a guest cannot access.
Default Guest Role	Role assigned to guest. Default: guest
Default Role	Role assigned to the Captive Portal user upon login. When both user and guest logon are enabled, the default role applies to the user logon; users logging in using the guest interface are assigned the guest role. Default: guest
Show Welcome Page	Displays the configured welcome page before the user is redirected to their original URL. If this option is disabled, users are redirected to the web URL immediately after they log in. Default: Enabled
Guest Login	Enables Captive Portal logon without authentication. Default: Disabled
Login Page	URL of the page that appears for the user logon. This can be set to any URL. Default: /auth/index.html
Logon wait maximum wait	Configure parameters for the logon wait interval Default: 10 seconds
Logon wait CPU utilization threshold	CPU utilization percentage above which the Logon wait interval is applied when presenting the user with the logon page. Default: 60%
Logon wait minimum wait	Minimum time, in seconds, the user will have to wait for the logon page to pop up if the CPU load is high. This works in conjunction with the Logon wait CPU utilization threshold parameter. Default: 5 seconds
Logout popout window	Enables a pop-up window with the Logout link for the user to logout after logon. If this is disabled, the user remains logged in until the user timeout period has elapsed or the station reloads. Default: Enabled
Max Authentication failures	Maximum number of authentication failures before the user is blacklisted. Default: 0
Use HTTP for authentication	Use HTTP protocol on redirection to the Captive Portal page. If you use this option, modify the captive portal policy to allow HTTP traffic. Default: disabled (HTTPS is used)
Redirect Pause	Time, in seconds, that the system remains in the initial welcome page before redirecting the user to the final web URL. If set to 0, the welcome page displays until the user clicks on the indicated link. Default: 10 seconds

Parameter	Description
server group	Name of the group of servers used to authenticate Captive Portal users.
Show FQDN	Allows the user to see and select the fully-qualified domain name (FQDN) on the login page. The FQDNs shown are specified when configuring individual servers for the server group used with captive portal authentication. Default: Disabled
Show Acceptable Use Policy Page	Show the acceptable use policy page before the logon page. Default: Disabled
Allow only one active user session	Allows only one active user session at a time. Default: Disabled
Add switch IP address in redirection URL	Sends the controller's IP address in the redirection URL when external captive portal servers are used. An external captive portal server can determine the controller from which a request originated by parsing the 'switchip' variable in the URL. Default: Disabled
Use CHAP (non-standard)	Use CHAP protocol. You should not use this option unless instructed to do so by a Dell representative. Default: Disabled
User Logon	Enables Captive Portal with authentication of user credentials. Default: Enabled
User VLAN Redirection-url	Sends the user's VLAN ID in the redirection URL when external captive portal servers are used.
Welcome Page	URL of the page that appears after logon and before redirection to the web URL. This can be set to any URL. Default: /auth/welcome.html
White List	Name of an existing white list on an IPv4 or IPv6 network destination. The white list contains authenticated websites that a guest can access.
White List	To add a netdestination to the captive portal whitelist, enter the destination host or subnet, then click Add . The netdestination will be added to the whitelist. To remove a netdestination from the whitelist, select it in the whitelist field, then click Delete . If you have not yet defined a netdestination, use the CLI command netdestination to define a destination host or subnet before you add it to the whitelist. This parameter requires the Public Access license.
Black List	To add a netdestination to the captive portal blacklist, enter the destination host or subnet, then click Add . The netdestination will be added to the blacklist. To remove a netdestination from the blacklist, select it in the blacklist field, then click Delete . If you have not yet defined a netdestination, use the CLI command netdestination to define a destination host or subnet before you add it to the blacklist. This parameter requires the Public Access license.

Enabling Optional Captive Portal Configurations

The following are optional captive portal configurations:

- ["Uploading Captive Portal Pages by SSID Association" on page 251](#)
- ["Changing the Protocol to HTTP" on page 251](#)
- ["Configuring Redirection to a Proxy Server" on page 252](#)

- ["Redirecting Clients on Different VLANs" on page 253](#)
- ["Web Client Configuration with Proxy Script" on page 254](#)

Uploading Captive Portal Pages by SSID Association

You can upload custom login pages for captive portal into the controller through the WebUI (refer to ["Creating and Installing an Internal Captive Portal" on page 256](#)). The SSID to which the client associates determines the captive portal login page displayed.

You specify the captive portal login page in the captive portal authentication profile, along with other configurable parameters. The initial user role configuration must include the applicable captive portal authentication profile instance. (In the case of captive portal in the base operating system, the initial user role is automatically created when you create the captive portal authentication profile instance.) You then specify the initial user role for captive portal in the AAA profile for the WLAN.

When you have multiple captive portal login pages loaded in the controller, you must configure a unique initial user role and user role, and captive portal authentication profile, AAA profile, SSID profile, and virtual AP profile for each WLAN that will use captive portal. For example, if you want to have different captive portal login pages for the engineering, business and faculty departments, you need to create and configure according to [Table 69](#).

Table 69: *Captive Portal login Pages*

Entity	Engineering	Business	Faculty
Captive portal login page	/auth/eng-login.html	/auth/bus-login.html	/auth/fac-login.html
Captive portal user role	eng-user	bus-user	fac-user
Captive portal authentication profile	eng-cp (Specify /auth/eng-login.html and eng-user)	bus-cp (Specify /auth/bus-login.html and bus-user)	fac-cp (Specify /auth/bus-login.html and fac-user)
Initial user role	eng-logon (Specify the eng-cp profile)	bus-logon (Specify the bus-cp profile)	fac-logon (Specify the fac-logon profile)
AAA profile	eng-aaa (Specify the eng-logon user role)	bus-aaa (Specify the bus-logon user role)	fac-aaa (Specify the fac-logon user role)
SSID profile	eng-ssid	bus-ssid	fac-ssid
Virtual AP profile	eng-vap	bus-vap	fac-vap

Changing the Protocol to HTTP

By default, the HTTPS protocol is used on redirection to the Captive Portal page. If you need to use HTTP instead, you need to do the following:

- Modify the captive portal authentication profile to enable the HTTP protocol.
- *For captive portal with role-based access only*—Modify the `captiveportal` policy to permit HTTP traffic instead of HTTPS traffic.

In the base operating system, the implicit ACL `captive-portal-profile` is automatically modified.

To change the protocol to HTTP via the WebUI:

1. Edit the captive portal authentication profile by navigating to the **Configuration > Security > Authentication > L3 Authentication** page.
 - a. Enable (select) “Use HTTP for authentication”.
 - b. Click **Apply**.
2. (For captive portal with role-based access only) Edit the **captiveportal** policy by navigating to the **Configuration > Security > Access Control > Policies** page.
 - a. Delete the rule for “user mswitch svc-https dst-nat”.
 - b. Add a new rule with the following values and move this rule to the top of the rules list:
 - source is user
 - destination is the mswitch alias
 - service is svc-http
 - action is dst-nat
 - c. Click **Apply**.

To change the protocol to HTTP via the command-line interface, access the CLI in config mode and issue the following commands:

```
(host)(config) #aaa authentication captive-portal profile
protocol-http
```

```
(For captive portal with role-based access only)
(host)(config) #ip access-list session captiveportal
no user alias mswitch svc-https dst-nat
user alias mswitch svc-http dst-nat
user any svc-http dst-nat 8080
user any svc-https dst-nat 8081
```

Configuring Redirection to a Proxy Server

You can configure captive portal to work with proxy Web servers. When proxy Web servers are used, browser proxy server settings for end users are configured for the proxy server’s IP address and TCP port. When the user opens a Web browser, the HTTP/S connection request must be redirected from the proxy server to the captive portal on the controller.

To configure captive portal to work with a proxy server:

- (For captive portal with base operating system) Modify the captive portal authentication profile to specify the proxy server’s IP address and TCP port.
- (For captive portal with role-based access) Modify the **captiveportal** policy to have traffic for the proxy server’s port destination NATed to port 8088 on the controller.

The base operating system automatically modifies the implicit ACL *captive-portal-profile*.

The following sections describe how use the WebUI and CLI to configure the captive portal with a proxy server.



NOTE: When HTTPS traffic is redirected from a proxy server to the controller, the user’s browser will display a warning that the subject name on the certificate does not match the hostname to which the user is connecting.

To redirect proxy server traffic using the WebUI:

1. For captive portal with Dell base operating system, edit the captive portal authentication profile by navigating to the **Configuration > Security > Authentication > L3 Authentication** page.
 - a. For Proxy Server, enter the IP address and port for the proxy server.
 - b. Click **Apply**.

2. For captive portal with role-based access, edit the **captiveportal** policy by navigating to the **Configuration > Security > Access Control > Policies** page.
3. Add a new rule with the following values:
 - a. Source is user
 - b. Destination is any
 - c. Service is TCP
 - d. Port is the TCP port on the proxy server
 - e. Action is dst-nat
 - f. IP address is the IP address of the proxy port
 - g. Port is the port on the proxy server
4. Click **Add** to add the rule. Use the up arrows to move this rule just below the rule that allows HTTP(S) traffic.
5. Click **Apply**.

To redirect proxy server traffic via the command-line interface, access the CLI in config mode and issue the following commands.

For captive portal with Dell base operating system:

```
(host) (config) #aaa authentication captive-portal profile
  proxy host ipaddr port port
```

For captive portal with role-based access:

```
(host) (config) #ip access-list session captiveportal
  user alias mswitch svc-https permit
  user any tcp port dst-nat 8088
  user any svc-http dst-nat 8080
  user any svc-https dst-nat 8081
```

Redirecting Clients on Different VLANs

You can redirect wireless clients that are on different VLANs (from the controller's IP address) to the captive portal on the controller. To do this:

1. Specify the redirect address for the captive portal.
2. For captive portal with the PEFNG license only, you need to modify the captiveportal policy that is assigned to the user. To do this:
 - a. Create a network destination alias to the controller interface.
 - b. Modify the rule set to allow HTTPS to the new alias instead of the mswitch alias.



NOTE: In the base operating system, the implicit ACL *captive-portal-profile* is automatically modified.

This example shows how to use the command-line interface to create a network destination called cp-redirect and use that in the captiveportal policy:

```
(host) (config) #ip cp-redirect-address ipaddr
```

For captive portal with PEFNG license:

```
(host) (config) #netdestination cp-redirect ipaddr
(host) (config) #ip access-list session captiveportal
  user alias cp-redirect svc-https permit
  user any svc-http dst-nat 8080
  user any svc-https dst-nat 8081
```

Web Client Configuration with Proxy Script

If the web client proxy configuration is distributed through a proxy script (a `.pac` file), you need to configure the `captiveportal` policy to allow the client to download the file. Note that in order to modify the `captiveportal` policy, you must have the PEFNG license installed in the controller.

To allow clients to download proxy script via the WebUI:

1. Edit the `captiveportal` policy by navigating to the **Configuration > Security > Access Control > Policies** page.
2. Add a new rule with the following values:
 - Source is user
 - Destination is host
 - Host IP is the IP address of the proxy server
 - Service is `svc-https` or `svc-http`
 - Action is permit
3. Click **Add** to add the rule. Use the up arrows to move this rule above the rules that perform destination NAT.
4. Click **Apply**.

To allow clients to download proxy script via the command-line interface, access the CLI in config mode and issue the following commands:

```
(host) (config) #ip access-list session captiveportal
  user alias mswitch svc-https permit
  user any tcp port dst-nat 8088
  user host ipaddr svc-https permit
  user any svc-http dst-nat 8080
  user any svc-https dst-nat 8081
```

Personalizing the Captive Portal Page

The following can be personalized on the default captive portal page:

- Captive portal background
- Page text
- Acceptance Use Policy

The background image and text should be visible to users with a browser window on a 1024 by 768 pixel screen. The background should not clash if viewed on a much larger monitor. A good option is to have the background image at 800 by 600 pixels, and set the background color to be compatible. The maximum image size for the background can be around 960 by 720 pixels, as long as the image can be cropped at the bottom and right edges. Leave space on the left side for the login box.

You can create your own web pages and install them in the controller for use with captive portal. See “Internal Captive Portal” on page 265

1. Navigate to the **Configuration > Management > Captive Portal > Customize Login Page** page.
You can choose one of three page designs. To select an existing design, click the first or the second page design present.

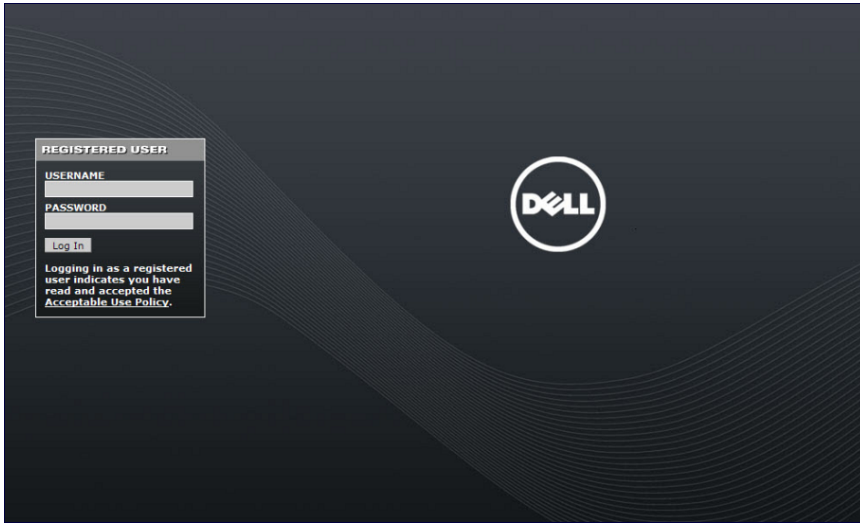

2. To customize the page background:
 - a. Select the **YOUR CUSTOM BACKGROUND** page.
 - b. Under **Additional options**, enter the location of the JPEG image in the Upload your own custom background field.
 - c. Set the background color in the Custom page background color field. The color code must be a hexadecimal value in the format #hhhhhh.
 - d. To view the page background changes, click **Submit** at the bottom on the page and then click the **View CaptivePortal** link. The **User Agreement Policy** page appears and displays the Captive Portal page as it will be seen by users.

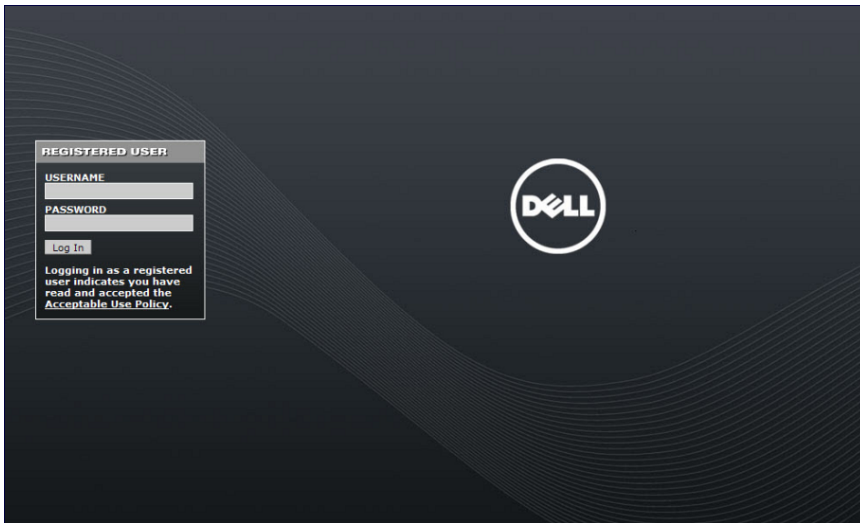

3. To customize the captive portal background text:
 - a. Enter the text that needs to be displayed in the **Page Text (in HTML format)** message box.
 - b. To view the background text changes, click **Submit** at the bottom on the page and then click the **View CaptivePortal** link. The **User Agreement Policy** page appears.
 - c. Click **Accept**. This displays the Captive Portal page as it will be seen by users.

4. To customize the text under the **Acceptable Use Policy**:
 - a. Enter the policy information in the **Policy Text** text box. Use this only in the case of guest logon.
 - b. To view the use policy information changes, click **Submit** at the bottom on the page and then click the **View CaptivePortal** link. The **User Agreement Policy** page appears. The text you entered appears in the **Acceptable Use Policy** text box.
 - c. Click **Accept**. This displays the Captive Portal page as it will be seen by users

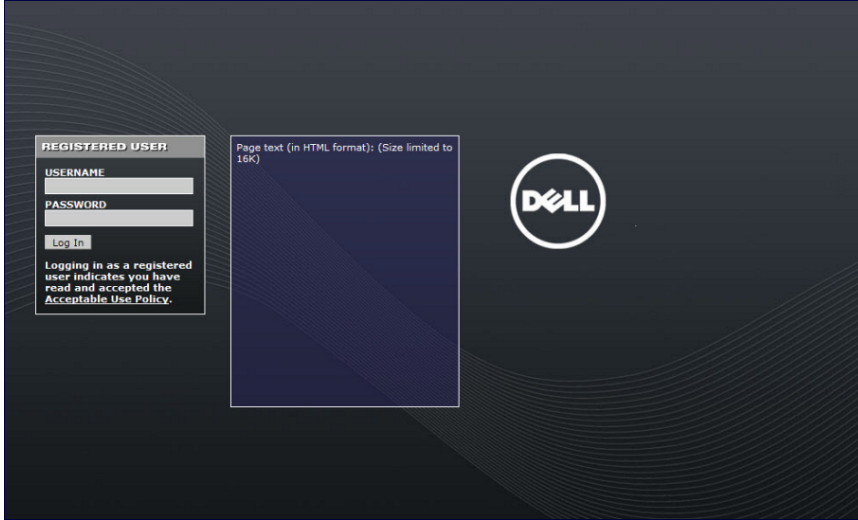

Creating and Installing an Internal Captive Portal

If you do not wish to customize the default captive portal page, you can use the following procedures to create and install a new internal captive portal page. This section describes the following topics:

- ["Creating a New Internal Web Page" on page 256](#)
- ["Installing a New Captive Portal Page" on page 258](#)
- ["Displaying Authentication Error Messages" on page 258](#)
- ["Reverting to the Default Captive Portal" on page 259](#)
- ["Configuring Localization " on page 259](#)
- ["Customizing the Welcome Page" on page 262](#)
- ["Customizing the Pop-Up box" on page 263](#)
- ["Customizing the Logged Out Box" on page 264](#)

Creating a New Internal Web Page

In addition to customizing the default captive portal page, you can also create your own internal web page. A custom web page must include an authentication form to authenticate a user. The authentication form can include any of the following variables listed in [Table 70](#):

Table 70: Web Page Authentication Variables

Variable	Description
user	(Required)
password	(Required)
FQDN	The fully-qualified domain name (this is dependent on the setting of the controller and is supported only in Global Catalog Servers software).

The form can use either the "get" or the "post" methods, but the "post" method is recommended. The form's action must absolutely or relatively reference https://<controller_IP>/auth/index.html/u.

You can construct an authentication form using the following HTML:

```
<FORM method="post" ACTION="/auth/index.html/u">
...
</FORM>
```

A recommended option for the <FORM> element is:

```
autocomplete="off"
```

This option prevents Internet Explorer from caching the form inputs. The form variables are input using any form control method available such as INPUT, SELECT, TEXTAREA and BUTTON. Example HTML code follows.

Username Example

Minimal:

```
<INPUT type="text" name="user">
```

Recommended Options:

```
accesskey="u"   Sets the keyboard shortcut to 'u'
SIZE="25"      "Sets the size of the input box to 25
VALUE=         ""Ensures no default value
```

Password Example

Minimal:

```
<INPUT type="password" name="password">
```

Recommended Options:

```
accesskey="p"   Sets the keyboard shortcut to 'p'
SIZE="25"      "Sets the size of the input box to 25
VALUE=         ""Ensures no default value
```

FQDN Example

Minimal:

```
<SELECT name=fqdn>
  <OPTION value="fqdn1" SELECTED>
  <OPTION value="fqdn2">
</SELECT>
```

Recommended Options:

```
None
```

Finally, an HTML also requires an input button:

```
<INPUT type="submit">
```

Basic HTML Example

```
<HTML>
  <HEAD>
  </HEAD>
  <BODY>
    <FORM method="post" autocomplete="off" ACTION="/auth/index.html/u">

    Username:<BR>
    <INPUT type="text" name="user" accesskey="u" SIZE="25" VALUE="">
    <BR>

    Password:<BR>
    <INPUT type="password" name="password" accesskey="p" SIZE="25"
      VALUE="">
    <BR>

    <INPUT type="submit">
    </FORM>
  </BODY>
</HTML>
```

You can find a more advanced example simply by using your browser's "view-source" function while viewing the default captive portal page.

Installing a New Captive Portal Page

You can install the captive portal page by using the Maintenance function of the WebUI.

Log into the WebUI and navigate to **Configuration > Management > Captive Portal > Upload Custom Login Pages**

This page lets you upload your own files to the controller. There are different page types that you can choose:

- Captive Portal Login (top level): This type uploads the file into the controller and sets the captive portal page to reference the file that you are uploading. Use with caution on a production controller as this takes effect immediately.
- Captive Portal Welcome Page: This type uploads the file that appears after logon and before redirection to the web URL. The display of the welcome page can be disabled or enabled in the captive portal profile.
- Content: The content page type allows you to upload all miscellaneous files that you need to reference from your main captive portal login page. This can be used for images, scripts or any other file that you need to reference. These files are uploaded into the same directory as the top level captive portal page and thus all files can be referenced relatively.

Uploaded files can be referenced using:

```
https://<controller_IP>/upload/custom/<CP-Profile-Name>/<file>
```

Displaying Authentication Error Messages

This section contains a script that performs the following tasks:

- When the user is redirected to the main captive portal login when there is authentication failure, the redirect URL includes a query parameter "errmsg" which java script can extract and display.
- Store the originally requested URL in a cookie so that once the user has authenticated, they are automatically redirected to its original page. Note that for this feature to work, you need ArubaOS release 2.4.2.0 or later. If you don't want this feature, delete the part of the script shown in red.

```
<script>
```

```

{
function createCookie(name,value,days)
{
    if (days)
    {
        var date = new Date();
        date.setTime(date.getTime()+ (days*24*60*60*1000));
        var expires = "; expires="+date.toGMTString();
    }
    else var expires = "";
    document.cookie = name+"="+value+expires+"; path=/";
}
var q = window.location.search;
var errmsg = null;

if (q && q.length > 1) {
    q = q.substring(1).split(/[=&]/);
    for (var i = 0; i < q.length - 1; i += 2) {
        if (q[i] == "errmsg") {
            errmsg = unescape(q[i + 1]);
            break;
        }
        if (q[i] == "host") {
            createCookie('url', unescape(q[i+1]), 0)
        }
    }
}

if (errmsg && errmsg.length > 0) {
    errmsg = "<div id='errorbox'>\n" + errmsg + "\n</div>\n";
    document.write(errmsg);
}
}
</script>

```

Reverting to the Default Captive Portal

You can reassign the default captive portal site using the "Revert to factory default settings" check box in the "Upload Custom Login Pages" section of the Maintenance tab in the WebUI.

Configuring Localization

The ability to customize the internal captive portal provides you with a very flexible interface to the Dell captive portal system. However, other than posting site-specific messages onto the captive portal website, the most common type of customization is likely to be language localization. This section describes a simple method for creating a native language captive portal implementation using the Dell internal captive portal system.

1. Customize the configurable parts of the captive portal settings to your liking. To do this, navigate to the **Configuration > Management > Captive Portal > Customize Login Page** in the WebUI:

For example, choose a page design, upload a custom logo and/or a custom background. Also include any page text and acceptable use policy that you would like to include. Put this in your target language or else you will need to translate this at a later time.

Ensure that Guest login is enabled or disabled as necessary by navigating to the **Configuration > Security > Authentication > L3 Authentication > Captive Portal Authentication Profile** page to create or edit the captive portal profile. Select or deselect "Guest Login".

2. Click **Submit** and then click on **View Captive Portal**. Check that your customization and text/html is correct, with the default interface still in English and the character set still autodetects to ISO-8859-1.

Repeat steps 1 and 2 until you are satisfied with your page.

3. Once you have a page you find acceptable, click on **View Captive Portal** one more time to display your login page. From your browser, choose "View->Source" or its equivalent. Your system will display the HTML source for the captive portal page. Save this source as a file on your local system.
4. Open the file that you saved in [step 3 on page 260](#), using a standard text editor, and make the following changes:
 - a. Fix the character set. The default `<HEAD>...</HEAD>` section of the file will appear as:

```
<head>
<title>Portal Login</title>

<link href="default1/styles.css" rel="stylesheet" media="screen" type="text/css" />
<script language="javascript" type="text/javascript">
    function showPolicy() {
        win = window.open("/auth/acceptableusepolicy.html", "policy",
width=550,scrollbars=1");
    }
</script>
</head>
```

In order to control the character set that the browser will use to show the text with, you will need to insert the following line inside the `<HEAD>...</HEAD>` element:

```
<meta http-equiv="Content-Type" content="text/html; charset=Shift_JIS"/>
```

Replace the "Shift_JIS" part of the above line with the character set that is used by your system. In theory, any character encoding that has been registered with IANA can be used, but you must ensure that any text you enter uses this character set and that your target browsers support the required character set encoding.

- b. The final `<HEAD>...</HEAD>` portion of the document should look similar to this:

```
<head>
<meta http-equiv="Content-Type" content="text/html; charset=Shift_JIS"/>
<title>Portal Login</title>

<link href="default1/styles.css" rel="stylesheet" media="screen" type="text/css" />
<script language="javascript" type="text/javascript">
    function showPolicy() {
        win = window.open("/auth/acceptableusepolicy.html", "policy", "height=5
scrollbars=1");
    }
</script>
</head>
```

- c. Fix references: If you have used the built-in preferences, you will need to update the reference for the logo image and the CSS style sheet.

To update the CSS reference, search the text for "`<link href`" and update the reference to include `"/auth/"` in front of the reference. The original link should look similar to the following:

```
<link href="default1/styles.css" rel="stylesheet" media="screen" type="text/css" />
```

This should be replaced with a link like the following:

```
<link href="/auth/default1/styles.css" rel="stylesheet" media="screen" type="text/css" />
```

The easiest way to update the image reference is to search for "src" using your text editor and updating the reference to include `"/auth/"` in front of the image file. The original link should look similar to the following:

```

```

This should be replaced with a link like this:

```

```

- d. Insert javascript to handle error cases:

When the controller detects an error situation, it will pass the user's page a variable called "errmsg" with a value of what the error is in English. Currently, only "Authentication Failed" is supported as a valid error message.

To localize the authentication failure message, replace the following text (it is just a few lines below the <body> tag):

```
<div id="errorbox" style="display: none;">
</div>
```

with the script below. You will need to translate the "Authentication Failed" error message into your local language and add it into the script below where it states: localized_msg="...":

```
<script>
{
  var q = window.location.search;
  var errmsg = null;
  if (q && q.length > 1) {
    q = q.substring(1).split(/[=&]/);
    for (var i = 0; i < q.length - 1; i += 2) {
      if (q[i] == "errmsg") {
        errmsg = unescape(q[i + 1]);
        break;
      }
    }
  }

  if (errmsg && errmsg.length > 0) {
    switch(errmsg) {
      case "Authentication Failed":
        localized_msg="Authentication Failed";
        break;
      default:
        localised_msg=errmsg;
        break;
    }
    errmsg = "<div id='errorbox'>\n" + localised_msg + "\n</div>\n";
    document.write(errmsg);
  };
}
</script>
```

- e. Translate the web page text. Once you have made the changes as above, you only need to translate the rest of the text that appears on the page. The exact text that appears will depend on the controller settings when you originally viewed the captive portal. You will need to translate all relevant text such as "REGISTERED USER", "USERNAME", "PASSWORD", the value="" part of the INPUT type="submit" button and all other text. Ensure that the character set you use to translate into is the same as you have selected in part i) above. Feel free to edit the HTML as you go if you are familiar with HTML.
5. After saving the changes made in step 4 above, upload the file to the controller using the **Configuration > Management > Captive Portal > Upload Custom Login Pages** section of the WebUI. Choose the captive portal profile from the drop-down menu. Browse your local computer for the file you saved. For Page Type, select "Captive Portal Login". Ensure that the "Revert to factory default settings" box is NOT checked and click **Apply**. This will upload the file to the controller and set the captive portal profile to use this page as the redirection page. In order to check that your site is operating correctly, go back to the "Customize Login Page" and click on "View Captive Portal" to view the page you have uploaded. Check that your browser has automatically detected the character set and that your text is not garbled.

To make any adjustments to your page, edit your file locally and simply re-upload to the controller in order to view the page again.

6. Finally, it is possible to customize the welcome page on the controller, however for language localization it is recommended to use an "external welcome page" instead. This can be a web site on an external server, or it can be a static page that is uploaded to a controller.

You set the welcome page in the captive portal authentication profile. This is the page that the user will be redirected to after successful authentication.

If this is required to be a page on the controller, the user needs to create their own web page (using the charset meta attribute in step 4 above). Upload this page to the designated controller in the same manner as uploading the captive portal login page under "**Configuration > Management > Captive Portal > Upload Custom Login Pages**". For Page Type, select "Captive Portal Welcome Page".

Any required client side script (CSS) and media files can also be uploaded using the "Content" Page Type, however file space is limited (use the CLI command **show storage** to see available space). Remember to leave ample room for system files.



NOTE: The "Registered User" and "Guest User" sections of the login page are implemented as graphics files, referenced by the default CSS styles. In order to change these, you will need to create new graphic files, download the CSS file, edit the reference to the graphics files, change the style reference in your index file and then upload all files as "content" to the controller.

A sample of a translated page is displayed in [Figure 71](#).

Figure 71: *Sample Translated Page*

Customizing the Welcome Page

Once a user is authenticated by the controller, a Welcome page is launched. The default welcome page depends on your configuration, but will look similar to [Figure 72](#):

Figure 72: *Default Welcome Page*

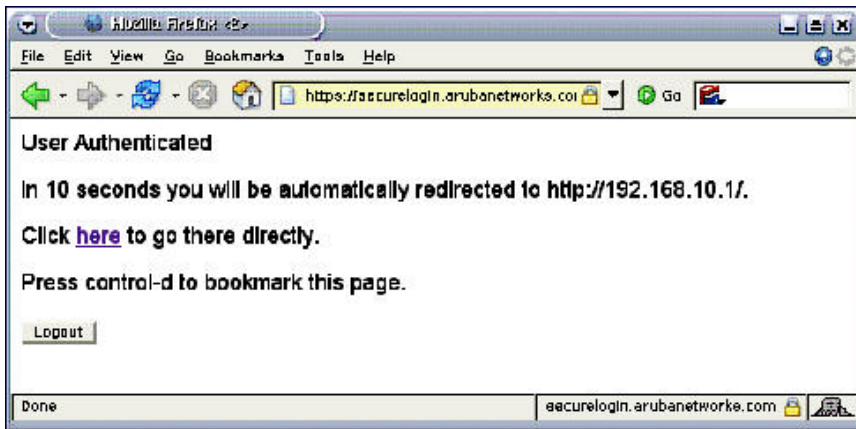

You can customize this welcome page by building your own HTML page and uploading it to the controller. You upload it to the controller by navigating to Management > Captive Portal > Upload Login Pages and select "Captive Portal Welcome Page" from the Page Type drop-down menu. This file is stored in a directory called "/upload/" on the controller using the file's original name.

In order to actually use this file, you will need to configure the welcome page on the controller. To do this use the CLI command: "aaa captive-portal welcome-page /upload/welc.html" where "welc.html" is the name of the file that you uploaded, or you can change the Welcome page in the captive portal authentication profile in the WebUI.

An example that will create the same page as displayed in [Figure 72](#) is shown below. The part in red will redirect the user to the web page you originally setup. For this to work, please follow the procedure described above in this document.

```
:  
  
<html>  
<head>  
<script>  
{  
  
function readCookie(name)  
{  
    var nameEQ = name + "=";  
    var ca = document.cookie.split(';');  
    for(var i=0;i < ca.length;i++)  
    {  
        var c = ca[i];  
        while (c.charAt(0)==' ') c = c.substring(1,c.length);  
        if (c.indexOf(nameEQ) == 0) return c.substring(nameEQ.length,  
c.length);  
    }  
    return null;  
}  
var cookieval = readCookie('url');  
    if (cookieval.length>0) document.write("<meta http-equiv=\"refresh\"  
content=\"2;url=http://"+cookieval+"\">");  
}  
</script>  
</head>  
<body bgcolor=white text=000000>  
<font face="Verdana, Arial, Helvetica, sans-serif" size=+1>  
    <b>User Authenticated </b>  
  
<p>In 2 seconds you will be automatically redirected to your original web page</p>  
<p> Press control-d to bookmark this page.</p>  
  
<FORM ACTION="/auth/logout.html">  
    <INPUT type="submit" name="logout" value="Logout">  
</FORM>  
</font>  
</body>  
</html>
```

Customizing the Pop-Up box

In order to customize the Pop-Up box, you must first customize your Welcome page. Once you have customized your welcome page, then you can configure your custom page to use a pop-up box. The default HTML for the pop-up box is:

```
<html>  
<body bgcolor=white text=000000>  
<font face="Verdana, Arial, Helvetica, sans-serif" size=+1>  
    <b>Logout</b></font>  
    <p>  
        <a href="/auth/logout.html"> Click to Logout </a>  
    </p>  
</body>  
</html>
```

If you wish your users to be able to logout using this pop-up box, then you must include a reference to `/auth/logout.html`. Once a user accesses this URL then the controller will log them out. It is easiest to simply edit the above HTML to suit your users and then upload the resulting file to the controller using the WebUI under **Configuration > Management > Captive Portal > Upload custom pages** and choose "content" as the page type.

Once you have completed your HTML, then you must get the clients to create the pop-up box once they have logged into the controller. This is done by inserting the following code into your welcome page text and re-uploading the welcome page text to your controller.

Common things to change:

- URL: set the URL to be the name of the pop-up HTML file that you created and uploaded. This should be preceded by `/upload/`
- Width: set `w` to be the required width of the pop-up box
- Height: set `h` to be the required height of the pop-up box
- Title: set the second parameter in the `window.open` command to be the title of the pop-up box. Be sure to include the quotes as shown:

```
<script language="JavaScript">
  var url="/upload/popup.html";
  var w=210;
  var h=80;
  var x=window.screen.width - w - 20;
  var y=window.screen.height - h - 60;
  window.open(url, 'logout', "toolbar=no,location=no,width="+w+",height="+h+",top="+y+",
left="+x+",screenX="+x+",screenY="+y);
</script>
```

Customizing the Logged Out Box

In order to customize the Logged Out box, you must first customize your Welcome page and also your Pop-Up box. To customize the message that occurs after you have logged out then you need to replace the URL that the pop-up box will access in order to log out with your own HTML file.

First you must write the HTML web page that will actually log out the user and will also display page that you wish. An example page is shown below. The key part that must be included is the `<iframe>..</iframe>` section. This is the part of the HTML that actually does the user logging out. The logout is always performed by the client accessing the `/auth/logout.html` file on the controller and so it is hidden in the html page here in order to get the client to access this page and for the controller to update its authentication status. If a client does not support the `iframe` tag, then the text between the `<iframe>` and the `</iframe>` is used. This is simply a 0 pixel sized image file that references `/auth/logout.html`. Either method should allow the client to logout from the controller.

Everything else can be customized.

```
<html>
<body bgcolor=white text=000000>

<iframe src='/auth/logout.html' width=0 height=0 frameborder=0><img src=/auth/logout.html
width=0 height=0></iframe>

<P><font face="Verdana, Arial, Helvetica, sans-serif" size=+1>
You have now logged out.</font></P>

<form> <input type="button" onclick="window.close()" name="close" value="Close
Window"></form>

</body>
</html>
```

After writing your own HTML, then you need to ensure that your customized pop-up box will access your new logged out file. In the pop-up box example above, you simply replace the "/auth/logout.html" with your own file that you upload to the controller. For example, if your customized logout HTML is stored in a file called "loggedout.html" then your "pop-up.html" file should reference it like this:

```
<html>
<body bgcolor=white text=000000>
<font face="Verdana, Arial, Helvetica, sans-serif" size=+1>
  <b>Logout</b></font>
  <p>
    <a href="/upload/loggedout.html"> Click to Logout </a>
  </p>
</body>
</html>
```

Creating Walled Garden Access

On the Internet, a walled garden typically controls a user's access to web content and services. The walled garden directs the user's navigation within particular areas to allow access to a selection of websites or prevent access to other websites.



NOTE: The Walled Garden feature can be used with the PEFNG or PEFV licenses.

Walled garden access is needed when an external or internal captive portal is used. A common example could be a hotel environment where unauthenticated users are allowed to navigate to a designated login page (for example, a hotel website) and all its contents.

Users who do not sign up for Internet service can view "allowed" websites (typically hotel property websites). The website names must be DNS-based (not IP address based) and support the option to define wildcards. This works for client devices with or without HTTP proxy settings.

When a user attempts to navigate to other websites not configured in the white list walled garden profile, the user is redirected back to the login page. In addition, the black listed walled garden profile is configured to explicitly block navigation to websites from unauthenticated users.

In the WebUI

1. Navigate to **Advanced Services > Stateful Firewall > Destination**.
2. Click **Add** to add a destination name.
3. Select the controller IP version, IPv4 or IPv6, from the **IP Version** drop-down menu.
4. In the **Destination Name** field, enter a name and click **Add**.
5. Select **name** from the **Rule Type** drop-down menu and add a hostname or wildcard with domain name to which an unauthenticated user is redirected.
6. Click **Apply**.
7. Navigate to **Configuration > Security > Authentication > L3 Authentication**.
8. Select **Captive Portal Authentication Profile**.
9. To allow users to access a domain, enter the destination name that contains the allowed domain names in the **White List** field. This stops unauthenticated users from viewing specific domains such as a hotel website. A rule in the white list must explicitly permit a traffic session before it is forwarded to the controller. The last rule in the white list denies everything else.
10. To deny users access to a domain, enter the destination name that contains prohibited domain names in the **Black List** field. This prevents unauthenticated users from viewing specific websites.

11. Click **Apply**.

In the CLI

This example configures a destination named Mywhite-list and adds the domain names, google.com and cnn.com to that destination. It then adds the destination name Mywhite-list (which contains the allowed domain names google.com and cnn.com) to the white list.

```
(host) (config) # netdestination "Mywhite-list"
(host) (config) #name google.com
(host) (config) #name cnn.com

(host) (config) #aaa authentication captive-portal default
(host) (Captive Portal Authentication Profile "default") #white-list Mywhite-list
```

Enabling Captive Portal Enhancements

This release of ArubaOS introduces the following enhancements in Captive Portal:

- Location information such as AP name and AP group name have been included in the Captive Portal redirect URL. The following example shows a Captive Portal redirect URL that contains the AP name and the AP group name:

```
https://securelogin.arubanetworks.com/cgi-
bin/login?cmd=login&mac=00:24:d7:ed:84:14&ip=10.15.104.13&ssid=example-test-
tunnel&apname=ap135&apgroup=example&url=http%3A%2F%2Fwww%2Eespncriinfo%2Ecom%2F
```

- A new option `redirect-url` is introduced in the Captive Portal Authentication profile which allows you to redirect the users to a specific URL after the authentication is complete.
- Captive Portal Login URL length has been increased from 256 characters to 2048 characters.
- Support for “?” (question mark) inside the Captive Portal login URL has been added.
- A new field, `description` has been introduced in the `netdestination` and `netdestination6` commands to provide a description about the netdestination up to 128 characters long.
- Support for configuring Whitelist in Captive Portal has been introduced.

The Captive Portal enhancements are available on Tunnel and Split-Tunnel forwarding modes.

Configuring the Redirect-URL

You can configure the Captive Portal redirect URL using the following commands:

```
(host) (config) # aaa authentication captive-portal REDIRECT
(host) (Captive Portal Authentication Profile "REDIRECT") #redirect-url <absolute-URL>
```

Example:

```
(host) (config) # aaa authentication captive-portal REDIRECT
(host) (Captive Portal Authentication Profile "REDIRECT") #redirect-url https://test-
login.php
```

Configuring the Login URL

You can configure a Captive Portal login URL up to 2048 characters using the following commands:

```
(host) (config) # aaa authentication captive-portal LOGIN
(host) (Captive Portal Authentication Profile "LOGIN") #login-page
"http://10.17.36.100/login.php?isinit=1&mac=00:11:22:33:44:55&loginURL=https://captiveportal-
login.test.aero/auth/index.html&originalURL=&statusURL=&error=&loginIn"
```



NOTE: You can configure the login URL with "?" (question mark) character in it provided the URL containing the question mark is within the double quotes.

Defining Netdestination Descriptions

You can provide a description (up to 128 characters) for the netdestination using the CLI.

Use the following commands to provide description for an IPv4 netdestination:

```
(host) (config) #netdestination Local-Server
(host) (config-dest) #description "This is a local server for IPv4 client registration"
```

Use the following commands to provide description for an IPv6 netdestination:

```
(host) (config) #netdestination6 Local-Server6
(host) (config-dest) #description "This is a local server for IPv6 client registration"
```

The following command displays the details of the specified IPv4 netdestination:

```
(host) (config-dest) #show netdestination Local-Server
```

```
Local-Server Description: This is a local server for IPv4 client registration
```

```
-----
Position  Type  IP addr  Mask-Len/Range
-----  -
1         name  0.0.0.1  yahooemail
2         name  0.0.0.2  arubanetworks
3         name  0.0.0.3  cricinfo
```

The following command displays the details of the specified IPv6 netdestination:

```
(host) (config-dest) #show netdestination Local-Server6
```

```
Local-Server6 Description: This is a local server for IPv6 client registration
```

```
-----
Position  Type  IP addr  Mask-Len/Range
-----  -
1         name  0.0.0.1  yahooemail
2         name  0.0.0.2  arubanetworks
3         name  0.0.0.3  cricinfo
```

Configuring a Whitelist

You can now configure a Whitelist in Captive Portal using the CLI.

Configuring the Netdestination for a Whitelist:

Use the following commands to configure a netdestination alias for Whitelist:

```
(host) (config) #netdestination whitelist
(host) (config-dest) #description guest_whitelist
(host) (config-dest) #name arubanetworks
```

Associating a Whitelist to Captive Portal Profile

Use the following CLI commands to associate a whitelist to the Captive Portal profile:

```
(host) (config) #aaa authentication captive-portal CP_Profile
(host) (Captive Portal Authentication Profile "CP_Profile") #white-list whitelist
```

Applying a Captive Portal Profile to a User-Role

Use the following commands to apply the Captive Portal profile to a user-role:

```
(host) (config) # user-role guest_role
```

```
(host) (config-role) #session-acl logon-control
(host) (config-role) #session-acl captiveportal
(host) (config-role) #captive-portal CP_Profile
```

Verifying a Whitelist Configuration

Use the following commands to verify the whitelist alias:

```
(host) (config) #show netdestination whitelist
```

```
whitelist Description: guest_whitelist
-----
Position  Type  IP addr  Mask-Len/Range
-----  -
1         name  0.0.0.6  arubanetworks
```

Verifying a Captive Portal Profile Linked to a Whitelist

Use the following commands to verify the Captive Portal profile linked to the whitelist:

```
(host) (config) #show aaa authentication captive-portal CP_Profile
```

```
Captive Portal Authentication Profile "CP_Profile"
-----
Parameter                               Value
-----
Default Role                             guest
Default Guest Role                       guest
Server Group                             default
Redirect Pause                            10 sec
User Login                                Enabled
Guest Login                               Disabled
Logout popup window                      Enabled
Use HTTP for authentication              Disabled
Logon wait minimum wait                  5 sec
Logon wait maximum wait                  10 sec
logon wait CPU utilization threshold      60 %
Max Authentication failures               0
Show FQDN                                Disabled
Use CHAP (non-standard)                  Disabled
Login page                               /auth/index.html
Welcome page                             /auth/welcome.html
Show Welcome Page                         Yes
Add switch IP address in the redirection URL Disabled
Adding user vlan in redirection URL       Disabled
Add a controller interface in the redirection URL N/A
Allow only one active user session        Disabled
White List                               whitelist
Black List                               N/A
Show the acceptable use policy page       Disabled
Redirect URL                             N/A
```

Verifying Dynamic ACLs for a Whitelist

Use the following commands to verify the dynamically created ACLs for the whitelist:

```
(host) (config) #show rights guest_role
```

```
Derived Role = 'guest_role'
Up BW:No Limit   Down BW:No Limit
L2TP Pool = default-l2tp-pool
PPTP Pool = default-pptp-pool
Periodic reauthentication: Disabled
```

ACL Number = 79/0
 Max Sessions = 65535

Captive Portal profile = CP_Profile

access-list List

```

-----
Position  Name                               Location
-----  -
1         CP_Profile_list_operations
2         logon-control
3         captiveportal
CP_Profile_list_operations
-----
Priority  Source  Destination  Service  Action  TimeRange  Log  Expired  Queue  TOS  8021P
Blacklist Mirror  DisScan  ClassifyMedia  IPv4/6
-----  -
1         user    whitelist    svc-http    permit 4         Low
2         user    whitelist    svc-https   permit 4         Low

logon-control
-----
Priority  Source  Destination  Service  Action  TimeRange  Log  Expired  Queue  TOS  8021P
Blacklist Mirror  DisScan  ClassifyMedia  IPv4/6
-----  -
1         user    any          udp 68     deny   4         Low
2         any     any          svc-icmp   permit 4         Low
3         any     any          svc-dns    permit 4         Low
4         any     any          svc-dhcp   permit 4         Low
5         any     any          svc-natt   permit 4         Low

captiveportal
-----
Priority  Source  Destination  Service  Action  TimeRange  Log  Expired  Queue
TOS  8021P  Blacklist  Mirror  DisScan  ClassifyMedia  IPv4/6
-----  -
1         user    controller    svc-https   dst-nat 8081 4         Low
2         user    any           svc-http    dst-nat 8080 4         Low
3         user    any           svc-https   dst-nat 8081 4         Low
4         user    any           svc-http-proxy1  dst-nat 8088 4         Low
5         user    any           svc-http-proxy2  dst-nat 8088 4         Low
6         user    any           svc-http-proxy3  dst-nat 8088 4         Low
  
```

Expired Policies (due to time constraints) = 0

Verifying DNS Resolved IP Addresses for Whitelisted URLs

Use the following command to verify the DNS resolved IP addresses for the whitelisted URLs:

```
(host) #show firewall dns-names ap-name <AP-name>
```

Example:

```
(host) #show firewall dns-names ap-name ap135
```

Firewall DNS names

```
-----
```

Index	Name	Id	Num-IP	List
-----	----	--	-----	----
0	bugzilla	10	1	0.0.0.0
1	cricinfo	9	0	
2	yahoo	1	0	
3	arubanetworks	6	1	1.1.1.1

Chapter 18

Virtual Private Networks

Wireless networks can use virtual private network (VPN) connections to further secure wireless data from attackers. The Dell controller can be used as a VPN concentrator that terminates all VPN connections from both wired and wireless clients.

This chapter describes the following topics:

- ["Planning a VPN Configuration" on page 271](#)
- ["Working with VPN Authentication Profiles" on page 274](#)
- ["Configuring a Basic VPN for L2TP/IPsec in the WebUI" on page 275](#)
- ["Configuring a VPN for L2TP/IPsec with IKEv2 in the WebUI" on page 279](#)
- ["Configuring a VPN for Smart Card Clients" on page 283](#)
- ["Configuring a VPN for Clients with User Passwords" on page 284](#)
- ["Configuring Remote Access VPNs for XAuth" on page 285](#)
- ["Working with Remote Access VPNs for PPTP" on page 287](#)
- ["Working with Site-to-Site VPNs" on page 288](#)
- ["Working with VPN Dialer" on page 293](#)

Planning a VPN Configuration

You can configure the controller for the following types of VPNs:

- Remote access VPNs allow hosts (for example, telecommuters or traveling employees) to connect to private networks (for example, a corporate network) over the Internet. Each host must run VPN client software which encapsulates and encrypts traffic and sends it to a VPN gateway at the destination network. The controller supports the following remote access VPN protocols:
 - Layer-2 Tunneling Protocol over IPsec (L2TP/IPsec)
 - Point-to-Point Tunneling Protocol (PPTP)
 - XAUTH IKE/IPsec
 - IKEv2 with Certificates
 - IKEv2 with EAP
- Site-to-site VPNs allow networks (for example, a branch office network) to connect to other networks (for example, a corporate network). Unlike a remote access VPN, hosts in a site-to-site VPN do not run VPN client software. All traffic for the other network is sent and received through a VPN gateway which encapsulates and encrypts the traffic.

Before enabling VPN authentication, you must configure the following:

- The default user role for authenticated VPN clients. See [Roles and Policies on page 296](#) for information about configuring user roles.
- The authentication server group the controller uses to validate the clients. See [Authentication Servers on page 168](#) for configuration details.



NOTE: A server-derived role, if present, takes precedence over the default user role.

You then specify the default user role and authentication server group in the VPN authentication **default** profile, as described in the following sections.

Selecting an IKE protocol

Controllers running ArubaOS version 6.1 and later support both IKEv1 and the newer IKEv2 protocol to establish IPsec tunnels. IKEv2 is simpler, faster, and a more reliable protocol than IKEv1, though both IKEv1 and IKEv2 support the same suite-B cryptographic algorithms.

If your IKE policy uses IKEv2, you should be aware of the following caveats when you configure your VPN:

- ArubaOS does not support separate pre-shared keys for both directions of an exchange; the same pre-shared key must be used by both peers. ArubaOS does not support mixed authentication with both pre-shared keys and certificates; each authentication exchange requires a single authentication type. (For example, if a client authenticates with a pre-shared key, the controller must also authenticate with a pre-shared key.)
- ArubaOS does not support IKEv2 mobility (MOBIKE), Authentication Headers (AH) or IP Payload Compression Protocol (IPComp).

Understanding Suite-B Encryption Licensing

Dell controllers support Suite-B cryptographic algorithms when the Advanced Cryptography (ACR) license is installed. [Table 73](#) describes the Suite-B algorithms supported by ArubaOS IKE Policies and IPsec tunnels. For further details on configuring a VPN to use Suite-B algorithms, see "[Configuring a VPN for L2TP/IPsec with IKEv2 in the WebUI](#)" on page 279.

Table 73: Suite-B Algorithms Supported by the ACR License

IKE Policies	Suite-B for IPsec tunnels
hash: SHA-256-128, SHA-384-192	Encryption: AES-128-GCM, AES-256-GCM
Diffie-Hellman (DH) Groups: ECP-256, ECP-384	Perfect Forward Secrecy (PFS): ECP-256, ECP-384
Pseudo-Random Function (PRF): HMAC_SHA_256, HMAC_SHA_384	—
Suite-B certificates: ECDSA-256, ECDSA-384	—



NOTE: IKE Suite-B AES-128-GCM and AES-256-GCM encryption is supported by the ArubaOS hardware. IKE Suite-B Diffie-Hellman and Certificate-based signature operations and hash, PFS, and PRF algorithm functions are performed by the ArubaOS software.

The following VPN clients support Suite-B algorithms when establishing an L2TP/IPsec VPN.

Table 74: Client Support for Suite-B

Client Operating System	Supported Suite-B IKE Authentication	Supported Suite-B IPsec Encryption
<ul style="list-style-type: none"> Windows 7 Windows Vista Windows XP 	<ul style="list-style-type: none"> IKEv1 Clients using ECDSA Certificates IKEv1/IKEv2 Clients using ECDSA Certificates with L2TP/PPP/EAP-TLS certificate user-authentication 	<ul style="list-style-type: none"> AES-128-GCM AES-256-GCM

The Suite-B algorithms described in [Table 73](#) are also supported by Site-to-Site VPNs between Dell controllers, or between a controller and a server running Windows 2008 or StrongSwan 4.3.

Working with IKEv2 Clients

Not all clients support the both the IKEv1 and IKEv2 protocols. Only the clients in [Table 75](#) support IKEv2 with the following authentication types:

Table 75: VPN Clients Supporting IKEv2

Windows 7 Client	StrongSwan 4.3 Client	VIA Client
<ul style="list-style-type: none"> Machine authentication with Certificates User-name password authentication using EAP-MSCHAPv2 or PEAP-MSCHAPv2 User smart-card authentication with EAP-TLS / IKEv2 <p>NOTE: Windows 7 clients using IKEv2 do not support pre-shared key authentication.</p>	<ul style="list-style-type: none"> Machine authentication with Certificates User-name password authentication using EAP-MSCHAPv2. Suite-B cryptographic algorithms 	<ul style="list-style-type: none"> Machine authentication with Certificates User-name password authentication using EAP-MSCHAPv2 EAP-TLS using Microsoft cert repository <p>NOTE: VIA clients using IKEv2 do not support pre-shared key authentication.</p>

Understanding Supported VPN AAA Deployments

If you want to simultaneously deploy various combinations of a VPN client, RAP-psk, RAP-certs and CAP on the same controller, see [Table 76](#).

Each row in this table specifies the allowed combinations of AAA servers for simultaneous deployment. Configuration rules include:

- RAP-certs can only use LocalDB-AP
- A RAP-psk and RAP-cert can only terminate on the same controller if the RAP VPN profile's AAA server uses Local-db.
- If a RAP-psk is using an external AAA server, then the RAP-cert cannot be terminated on the same controller.
- Clients can use any type of AAA server, regardless of RAP/CAP authentication configuration server.

Table 76: Supported VPN AAA Deployments

VPN Client	RAP psk	RAP certs	CAP
External AAA server 1	LocalDB	LocalDB-AP	CPSEC-whitelist

VPN Client	RAP psk	RAP certs	CAP
External AAA server 1	External AAA server 1	Not supported	CPSEC-whitelist
External AAA server 1	External AAA server 2	Not supported	CPSEC-whitelist
LocalDB	LocalDB	LocalDB-AP	CPSEC-whitelist
LocalDB	External AAA server 1	Not supported	CPSEC-whitelist

Working with Certificate Groups

The certificate group feature allows you to access multiple types of certificates on the same controller. To create a certificate group, use the following command:

```
(host) (config) #crypto-local isakmp certificate-group server-certificate server_certificate
ca-certificate ca_certificate
```

You can view existing certificate groups using:

```
show crypto-local isakmp certificate-group
```

Working with VPN Authentication Profiles

VPN Authentication profiles identify a user role for authenticated VPN clients, an authentication server, and the server group to which the authentication server belongs. There are three predefined VPN authentication profiles: **default**, **default-rap** and **default-cap**. These different profiles allow you to use different authentication servers, user roles and IP pools for VPN, remote AP and campus AP clients.



NOTE: The **default** and **default-rap** profiles are configurable, but the **default-cap** profile cannot be edited.

Table 77: *Predefined Authentication Profile settings*

Parameter	default	default-rap	default-cap
Default Role for authenticated users	default-vpn-role	default-vpn-role	sys-ap-role 0
Maximum allowed authentication failures (The number of contiguous authentication failures before the station is blacklisted.)	0 (feature is disabled)	0 (feature is disabled)	0 (feature is disabled)
Check certificate common name against AAA server	disabled	enabled	enabled
Authentication server group			internal

To edit the **default** VPN authentication profile:

1. Navigate to the **Configuration > Security > Authentication > L3 Authentication** page.
2. In the **Profiles** list in the left window pane, select the **default** VPN Authentication Profile.
3. Click the **Default Roledrop**-down list and select the default user role for authenticated VPN users. (For detailed information on creating and managing user roles and policies, see "[Roles and Policies](#)" on page 296.)

4. (Optional) If you use client certificates for user authentication, select the **Check certificate common name against AAA server** checkbox to verify that the certificate's common name exists in the server. This parameter is enabled by default in the default-cap and default-rap VPN profiles, and disabled by default on all other VPN profiles.
5. (Optional) Set Max Authentication failures to an integer value (the default value is 0, which disables this feature).
6. Click **Apply**.
7. In the **Default** profile menu in the left window pane, select **Server Group**.
8. From the **Server Group** drop-down list, select the server group to be used for VPN authentication.
9. Click **Apply**.

To configure VPN authentication via the command-line interface, access the CLI in config mode and issue the following commands:

```
(host)(config) #aaa authentication vpn default
    cert-cn-lookup
    clone
    default-role <role>
    max-authentication-failure <number>
    server-group <name>
```

Configuring a Basic VPN for L2TP/IPsec in the WebUI

The combination of Layer-2 Tunneling Protocol and Internet Protocol Security (L2TP/IPsec) is a highly-secure technology that enables VPN connections across public networks such as the Internet. L2TP/IPsec provides both a logical transport mechanism on which to transmit PPP frames as well as tunneling or encapsulation so that the PPP frames can be sent across an IP network. L2TP/IPsec relies on the PPP connection process to perform user authentication and protocol configuration. With L2TP/IPsec, the user authentication process is encrypted using the Data Encryption Standard (DES) or Triple DES (3DES) algorithm.

L2TP/IPsec using IKEv1 requires two levels of authentication:

- Computer-level authentication with a preshared key to create the IPsec security associations (SAs) to protect the L2TP-encapsulated data.
- User-level authentication through a PPP-based authentication protocol using passwords, SecureID, digital certificates, or smart cards after successful creation of the SAs.



NOTE: Note that only Windows 7 clients, StrongSwan 4.3 clients and VIA clients support IKEv2. For additional information on the authentication types supported by these clients, see "[Working with IKEv2 Clients](#)" on page 273.

Use the following procedures to configure a remote access VPN for L2TP IPsec for clients using pre-shared keys, certificates or EAP for authentication using the WebUI.

- "[Defining Authentication Method and Server Addresses](#)" on page 279
- "[Defining Address Pools](#)" on page 280
- "[Enabling Source NAT](#)" on page 280
- "[Selecting Certificates](#)" on page 280
- "[Defining IKEv1 Shared Keys](#)" on page 277
- "[Configuring IKE Policies](#)" on page 281
- "[Setting the IPsec Dynamic Map](#)" on page 282
- "[Finalizing WebUI changes](#)" on page 282

Defining Authentication Method and Server Addresses

1. First, define the authentication method and server addresses
2. Navigate to **Configuration > Advanced Services > VPN Services** and click the **IPSEC** tab.
3. To enable L2TP, select **Enable L2TP** (this is enabled by default).
4. Select the authentication method for IKEv1 clients. Currently supported methods are:
 - Password Authentication Protocol (PAP)
 - Extensible Authentication Protocol (EAP)
 - Challenge Handshake Authentication Protocol (CHAP)
 - Microsoft Challenge Handshake Authentication Protocol (MSCHAP)
5. Configure the IP addresses of the primary and secondary Domain Name System (DNS) servers and primary and secondary Windows Internet Naming Service (WINS) Server that are pushed to the VPN client.

Defining Address Pools

Next, define the pool from which the clients are assigned addresses.

1. In the **Address Pools** section of the **IPSEC** tab, click **Add** to open the **Add Address Pool** page.
2. Specify the pool name, the start address, and the end address.
3. Click **Done** to apply the configuration.

Enabling Source NAT

In the **Source NAT** section of the **IPSEC** tab, select **Enable Source NAT** if the IP addresses of clients need to be translated to access the network. If you enabled source NAT, click the **NAT pool** drop-down list and select an existing NAT pool. If you have not yet created the NAT pool you want to use:

1. Navigate to **Configuration > IP > NAT Pools**.
2. Click **Add**.
3. In the **Pool Name** field, enter a name for the new NAT pool, up to 63 alphanumeric characters.
4. In the **Start IP address** field, enter the dotted-decimal IP address that defines the beginning of the range of source NAT addresses in the pool.
5. In the **End IP address** field, enter the dotted-decimal IP address that defines the end of the range of source NAT addresses in the pool.
6. In the **Destination NAT IP Address** field, enter the destination NAT IP address in dotted-decimal format. If you do not enter an address into this field, the NAT pool uses the destination NAT IP 0.0.0.0.
7. Click **Done** to close the NAT pools tab
8. Navigate to **Configuration > Advanced Services > VPN Services** and click the **IPSEC** tab to return to the **IPsec** window.
9. Click the **NAT Pool** drop-down list and select the NAT pool you just created.

Selecting Certificates

If you are configuring a VPN to support machine authentication using certificates, define the IKE Server certificates for VPN clients using IKE. Note that these certificate must be imported into the controller, as described in [Management Access on page 625](#).

1. Select the server certificate for client machines using IKE by clicking the **IKE Server Certificate** drop-down list and selecting an available certificate name.
2. If you are configuring a VPN to support clients using certificates, you must also assign one or more trusted CA certificates to VPN clients.

- a. Under CA Certificate Assigned for VPN-clients, click **Add**.
- b. Select a CA certificate from the drop-down list of CA certificates imported in the controller.
- c. Click **Done**.
- d. Repeat the above steps to add additional CA certificates.

Defining IKEv1 Shared Keys

If you are configuring a VPN to support IKEv1 and clients using pre-shared keys, You can configure a global IKE key or configure an IKE key for each subnet. Make sure that this key matches the key on the client.

1. In the **IKE Shared Secrets** section of the **IPsec** tab, click **Add** to open the **Add IKE Secret** page.
2. Enter the subnet and subnet mask. To make the IKE key global, specify 0.0.0.0 for both values.
3. Enter the IKE Shared Secret and Verify IKE Shared Secret.
4. Click **Done** to apply the configurations.

Configuring IKE Policies

ArubaOS contains several predefined default IKE policies, as described in [Table 79](#). If you do not want to use any of these predefined policies, you can use the procedures below to edit an existing policy or create your own custom IKE policy instead.

 NOTE: The IKE policy selections, along with any preshared key, need to be reflected in the VPN client configuration. When using a third-party VPN client, set the VPN configuration on clients to match the choices made above. In case the Dell dialer is used, these configuration need to be made on the dialer prior to downloading the dialer onto the local client

1. Scroll down to the **IKE Policies** section of the **IPSEC** tab, then click **Edit** to edit an existing policy or click **Add** to create a new policy.
2. Enter a number into the **Priority** field to set the priority for this policy. Enter a priority to 1 for the configuration to take priority over the Default setting.
3. Select the IKE version. Click the **Version** drop-down list and select **V1** for IKEv1 or **V2** for IKEv2.
4. Set the Encryption type. Click the **Encryption** drop-down list and select one of the following encryption types.
 - DES
 - 3DES
 - AES128
 - AES192
 - AES256
5. Set the HASH function. Click the **Hash** drop-down list and select one of the following hash types.
 - MD5
 - SHA
 - SHA1-96
 - SHA2-256-128
 - SHA2-384-192
6. ArubaOS VPNs support client authentication using pre-shared keys, RSA digital certificates, or Elliptic Curve Digital Signature Algorithm (ECDSA) certificates. To set the authentication type for the IKE rule, click the **Authentication** drop-down list and select one of the following types:
 - Pre-Share (for IKEv1 clients using pre-shared keys)
 - RSA (for clients using certificates)
 - ECDSA-256 (for clients using certificates)

- ECDSA-384 (for clients using certificates)
7. Diffie-Hellman is a key agreement algorithm that allows two parties to agree upon a shared secret, and is used within IKE to securely establish session keys. To set the Diffie Hellman Group for the ISAKMP policy, click the **Diffie Hellman Group** drop-down list and select one of the following groups:
 - Group 1: 768-bit Diffie Hellman prime modulus group.
 - Group 2: 1024-bit Diffie Hellman prime modulus group.
 - Group 19: 256-bit random Diffie Hellman ECP modulus group.
 - Group 20: 384-bit random Diffie Hellman ECP modulus group.
 8. Set the **Security Association Lifetime** to define the lifetime of the security association, in seconds. The default value is 7200 seconds. To change this value, uncheck the **default** checkbox and enter a value from 300 to 86400 seconds.
 9. Click **Done** to activate the changes, and return to the previous window

Setting the IPsec Dynamic Map

Dynamic maps enable IPsec SA negotiations from dynamically addressed IPsec peers. ArubaOS has a predefined IPsec dynamic map for IKEv1. If you do not want to use this predefined map, you can use the procedures below to edit an existing map or create your own custom IPsec dynamic map instead.

1. Scroll down to the IPsec Dynamic Map section of the IPSEC tab, then click **Edit** by a map name to edit an existing map or click **Add** to create a new map.
2. In the **Name** field, enter a name for the dynamic map
3. In the **Priority** field, enter a priority number for the map. Negotiation requests for security associations try to match the highest-priority map first. If that map does not match, the negotiation request continues down the list to the next-highest priority map until a match is made.
4. Click the **Version** drop-down list and select V1 to create an IPsec map for remote peers using IKEv1.
5. (Optional) Configure Perfect Forward Secrecy (PFS) settings for the dynamic peer by assigning a Diffie-Hellman prime modulus group. PFS provides an additional level of security by ensuring that the IPsec SA key was not derived from any other key, and therefore can not be compromised if another key is broken. Click the **Set PFS** drop-down list and select one of the following groups:
 - Group 1: 768-bit Diffie Hellman prime modulus group.
 - Group 2: 1024-bit Diffie Hellman prime modulus group.
 - Group 19: 256-bit random Diffie Hellman ECP modulus group.
 - Group 20: 384-bit random Diffie Hellman ECP modulus group.
6. Select the transform set for the map to define a specific encryption and authentication type used by the dynamic peer. Click the **Transform Set** drop-down list, and select the transform set for the dynamic peer.



NOTE: To view current configuration settings for an IPsec transform-set, access the command-line interface and issue the command `crypto ipsec transform-set tag <transform-set-name>`.

7. Set the **Security Association Lifetime** to define the lifetime of the security association for the dynamic peer, in seconds. The default value is 7200 seconds. To change this value, uncheck the **default** checkbox and enter a value from 300 to 86400 seconds.
8. Click **Done** to return to the previous window.

Finalizing WebUI changes

When you have finished configuring your IPsec VPN settings, click **Apply** to apply the new settings before navigating to other pages.

Configuring a Basic L2TP VPN in the CLI

Use the following procedures to use the command-line interface to configure a remote access VPN for L2TP IPsec.

1. Define the authentication method and server addresses:

```
(host)(config) #vpdn group l2tp
enable
client configuration {dns|wins} <ipaddr1> [<ipaddr2>]
```

2. Enable authentication methods for IKEv1 clients

```
vpdn group l2tp ppp authentication {cache-securid|chap|eap|mschap|mschapv2|pap}
```

3. Create address pools:

```
(host)(config) #ip local pool <pool> <start-ipaddr> <end-ipaddr>
```

4. Configure source NAT

```
(host)(config) #ip access-list session srcnatuser any any src-nat pool <pool> position 1
```

5. If you are configuring a VPN to support machine authentication using certificates, define server certificates for VPN clients using IKEv1.

For IKEv1: (host)(config) #crypto-local isakmp server-certificate <cert>

6. If you are configuring a VPN to support IKEv1 Clients using pre-shared keys, you can configure a global IKE key by entering 0.0.0.0 for both the address and netmask parameters in the command below, or configure an IKE key for an individual subnet by specifying the IP address and netmask for that subnet.

```
crypto isakmp key <key> address <ipaddr> netmask <mask>
```

7. Define IKE Policies:

```
(host)(config) #crypto isakmp policy <priority>
encryption {3des|aes128|aes192|aes256|des}
version v1|v2
authentication {pre-share|rsa-sig|ecdsa-256|ecdsa-384}
group {1|2|19|20}
hash {md5|sha|sha1-96|sha2-256-128|sha2-384-192}
lifetime <seconds>
```

Configuring a VPN for L2TP/IPsec with IKEv2 in the WebUI

Only clients running Windows 7, StrongSwan 4.3 and Dell VIA support IKEv2. For additional information on the authentication types supported by these clients, see ["Working with IKEv2 Clients " on page 273"](#).

Use the following procedures to in the WebUI configure a remote access VPN for IKEv2 clients using certificates.

- ["Defining Authentication Method and Server Addresses" on page 279](#)
- ["Defining Address Pools" on page 280](#)
- ["Enabling Source NAT" on page 280](#)
- ["Selecting Certificates" on page 280](#)
- ["Configuring IKE Policies" on page 281](#)
- ["Setting the IPsec Dynamic Map" on page 282](#)
- ["Finalizing WebUI changes" on page 282](#)

Defining Authentication Method and Server Addresses

1. First, define the authentication method and server addresses
2. Navigate to **Configuration > Advanced Services > VPN Services** and click the **IPSEC** tab.
3. To enable L2TP, select **Enable L2TP** (this is enabled by default).
4. Select the authentication method for IKEv1 clients. Currently supported methods are:

- Password Authentication Protocol (PAP)
 - Extensible Authentication Protocol (EAP)
 - Challenge Handshake Authentication Protocol (CHAP)
 - Microsoft Challenge Handshake Authentication Protocol (MSCHAP)
5. Configure the IP addresses of the primary and secondary Domain Name System (DNS) servers and primary and secondary Windows Internet Naming Service (WINS) Server that is pushed to the VPN client.

Defining Address Pools

Next, define the pool from which the clients are assigned addresses.

1. In the **Address Pools** section of the **IPSEC** tab, click **Add** to open the **Add Address Pool** page.
2. Specify the pool name, the start address, and the end address.
3. Click **Done** to apply the configuration.

Enabling Source NAT

In the **Source NAT** section of the **IPSEC** tab, select **Enable Source NAT** if the IP addresses of clients need to be translated to access the network. If you enabled source NAT, click the **NAT pool** drop-down list and select an existing NAT pool. If you have not yet created the NAT pool you want to use:

1. Navigate to **Configuration > IP > NAT Pools**.
2. Click **Add**.
3. In the **Pool Name** field, enter a name for the new NAT pool, up to 63 alphanumeric characters.
4. In the **Start IP address** field, enter the dotted-decimal IP address that defines the beginning of the range of source NAT addresses in the pool.
5. In the **End IP address** field, enter the dotted-decimal IP address that defines the end of the range of source NAT addresses in the pool.
6. In the **Destination NAT IP Address** field, enter the destination NAT IP address in dotted-decimal format. If you do not enter an address into this field, the NAT pool uses the destination NAT IP 0.0.0.0.
7. Click **Done** to close the NAT pools tab.
8. Navigate to **Configuration > Advanced Services > VPN Services** and click the **IPSEC** tab to return to the **IPSEC** window.
9. Click the **NAT Pool** drop-down list and select the NAT pool you just created.

Selecting Certificates

To configure the VPN to support machine authentication using certificates, define the IKE Server certificates for VPN clients using IKEv2. Note that these certificate must be imported into the controller, as described in [Management Access on page 625](#).

1. Select the IKEv2 server certificate for client machines using IKEv2 by clicking the **IKEv2 Server Certificate** drop-down list and selecting an available certificate name.
2. If you are configuring a VPN to support IKEv2 clients using certificates, you must also assign one or more trusted CA certificates to VPN clients.
 - a. Under **CA Certificate Assigned for VPN-clients**, click **Add**.
 - b. Select a CA certificate from the drop-down list of CA certificates imported in the controller.
 - c. Click **Done**.
 - d. Repeat the above steps to add additional CA certificates.

Configuring IKE Policies

ArubaOS contains several predefined default IKE policies, as described in [Table 79](#). If you do not want to use any of these predefined policies, you can use the procedures below to edit an existing policy or create your own custom IKE policy instead.



NOTE: The IKE policy selections need to be reflected in the VPN client configuration. When using a third-party VPN client, set the VPN configuration on clients to match the choices made above. In case the Dell dialer is used, these configuration need to be made on the dialer prior to downloading the dialer onto the local client

1. Scroll down to the **IKE Policies** section of the **IPSEC** tab, then click **Edit** to edit an existing policy or click **Add** to create a new policy.
2. Enter a number into the **Priority** field to set the priority for this policy. Enter a priority to 1 for the configuration to take priority over the Default setting.
3. Select the IKE version. Click the **Version** drop-down list and select **V2** for IKEv2.
4. Set the Encryption type. Click the **Encryption** drop-down list and select one of the following encryption types.
 - DES
 - 3DES
 - AES128
 - AES192
 - AES256
5. Set the HASH function. Click the **Hash** drop-down list and select one of the following hash types.
 - MD5
 - SHA
 - SHA1-96
 - SHA2-256-128
 - SHA2-384-192
6. ArubaOS VPNs support IKEv2 client authentication using RSA digital certificates, or Elliptic Curve Digital Signature Algorithm (ECDSA) certificates. To set the authentication type for the IKE rule, click the **Authentication** drop-down list and select one of the following types:
 - RSA
 - ECDSA-256
 - ECDSA-384
7. Diffie-Hellman is a key agreement algorithm that allows two parties to agree upon a shared secret, and is used within IKE to securely establish session keys. To set the Diffie Hellman Group for the ISAKMP policy, click the **Diffie Hellman Group** drop-down list and select one of the following groups:
 - Group 1: 768-bit Diffie Hellman prime modulus group.
 - Group 2: 1024-bit Diffie Hellman prime modulus group.
 - Group 19: 256-bit random Diffie Hellman ECP modulus group.
 - Group 20: 384-bit random Diffie Hellman ECP modulus group.
8. Set the Pseudo-Random Function (PRF) value. This algorithm is an HMAC function to be used to hash certain values during the key exchange.
 - PRF-HMAC-MD5
 - PRF-HMAC-SHA1
 - PRF-HMAC-SHA256

- PRF-HMAC-SHA384
- Set the **Security Association Lifetime** to define the lifetime of the security association, in seconds. The default value is 7200 seconds. To change this value, uncheck the default checkbox and enter a value from 300 to 86400 seconds.
 - Click **Done** to activate the changes, and return to the previous window

Setting the IPsec Dynamic Map

Dynamic maps enable IPsec SA negotiations from dynamically addressed IPsec peers. ArubaOS has a predefined IPsec dynamic maps for IKEv2. If you do not want to use of these predefined maps, you can use the procedures below to edit an existing map or create your own custom IPsec dynamic map instead.

- Scroll down to the IPsec Dynamic Map section of the IPSEC tab, then click **Edit** by a map name to edit an existing map or click **Add** to create a new map.
- In the **Name** field, enter a name for the dynamic map
- In the **Priority** field, enter a priority number for the map. Negotiation requests for security associations try to match the highest-priority map first. If that map does not match, the negotiation request continues down the list to the next-highest priority map until a match is made.
- Click the **Version** drop-down list and select **v2** to create a map for remote peers using IKEv2.
- (Optional) Configure Perfect Forward Secrecy (PFS) settings for the dynamic peer by assigning a Diffie-Hellman prime modulus group. PFS provides an additional level of security by ensuring that the IPsec SA key was not derived from any other key, and therefore can not be compromised if another key is broken. Click the **Set PFS** drop-down list and select one of the following groups:
 - Group 1: 768-bit Diffie Hellman prime modulus group.
 - Group 2: 1024-bit Diffie Hellman prime modulus group.
 - Group 19: 256-bit random Diffie Hellman ECP modulus group.
 - Group 20: 384-bit random Diffie Hellman ECP modulus group.
- Select the transform set for the map to define a specific encryption and authentication type used by the dynamic peer. Click the **Transform Set** drop-down list, and select the transform set for the dynamic peer.



NOTE: To view current configuration settings for an IPsec transform-set, access the command-line interface and issue the command **crypto ipsec transform-set tag <transform-set-name>**.

- Set the **Security Association Lifetime** to define the lifetime of the security association for the dynamic peer, in seconds. The default value is 7200 seconds. To change this value, uncheck the **default** checkbox and enter a value from 300 to 86400 seconds.
- Click **Done** to return to the previous window.

Finalizing WebUI changes

When you have finished configuring your IPsec VPN settings, click **Apply** to apply the new settings before navigating to other pages.

In the CLI

Use the following procedures to use the command-line interface to configure a remote access VPN for L2TP IPsec using IKEv2.

- Define the server addresses:

```
(host) (config) #vpdn group l2tp
enable
client configuration {dns|wins} <ipaddr1> [<ipaddr2>]
```

2. Enable authentication methods for IKEv2 clients:

```
(host) (config) #crypto isakmp eap-passthrough {eap-mschapv2|eap-peap|eap-tls}
```
3. Create address pools:

```
(host) (config) #ip local pool <pool> <start-ipaddr> <end-ipaddr>
```
4. Configure source NAT

```
(host) (config) #ip access-list session srcnat user any any src-nat pool <pool> position 1
```
5. If you are configuring a VPN to support machine authentication using certificates, define server certificates for VPN clients using IKEv2.

```
(host) (config) #crypto-local isakmp server-certificate <cert>
```
6. Define IKEv2 Policies:

```
(host) (config) #crypto isakmp policy <priority>
encryption {3des|aes128|aes192|aes256|des}
version v2
authentication {pre-share|rsa-sig|ecdsa-256|ecdsa-384}
group {1|2|19|20}
hash {md5|sha|sha1-96|sha2-256-128|sha2-384-192}
prf PRF-HMAC-MD5|PRF-HMAC-SHA1|PRF-HMAC-SHA256|PRF-HMAC-SHA384
lifetime <seconds>
```
7. Define IPsec Tunnel parameters

```
(host) (config) #crypto ipsec
mtu <max-mtu>
transform-set <transform-set-name> esp-3des|esp-aes128|esp-aes128-gcm|esp-aes192|esp-
aes256|esp-aes256-gcm|esp-des esp-md5-hmac|esp-null-mac|esp-sha-hmac
```

Configuring a VPN for Smart Card Clients

This section describes how to configure a remote access VPN on the controller for Microsoft L2TP/IPsec clients with smart cards. (A smart card contains a digital certificate which allows user-level authentication without the user entering a username and password.) As described previously in this chapter, L2TP/IPsec requires two levels of authentication: first, IKE SA (machine) authentication, and then user-level authentication with an IKEv2 or PPP-based authentication protocol.

Microsoft clients running Windows 7 (or later versions) support both IKEv1 and IKEv2. Microsoft clients using IKEv2 support machine authentication using RSA certificates (but not ECDSA certificates or pre-shared keys) and smart card user-level authentication with EAP-TLS over IKEv2.



NOTE: Windows 7 clients without smart cards also support user password authentication using EAP-MSCHAPv2 or PEAP-MSCHAPv2.

Working with Smart Card clients using IKEv2

To configure a VPN for Windows 7 clients using smart cards and IKEv2, follow the procedure described in ["Configuring a VPN for L2TP/IPsec with IKEv2 in the WebUI" on page 279](#), and ensure that the following settings are configured

- L2TP is enabled.
- User Authentication is set to **EAP-TLS**.
- IKE version is set to **V2**
- The IKE policy is configured for **ECDSA** or **RSA** certificate authentication.

Working with Smart Card Clients using IKEv1

Microsoft clients using IKEv1 (including clients running Windows Vista or earlier versions of Windows) only support machine authentication using a pre-shared key. In this scenario, user-level authentication is performed by an external RADIUS server using PPP EAP-TLS and client and server certificates are mutually authenticated during the EAP-TLS exchange. During the authentication, the controller encapsulates EAP-TLS messages from the client into RADIUS messages and forwards them to the server.

On the controller, you need to configure the L2TP/IPsec VPN with EAP as the PPP authentication and IKE policy for preshared key authentication of the SA.



NOTE: On the RADIUS server, you must configure a remote access policy to allow EAP authentication for smart card users and select a server certificate. The user entry in Microsoft Active Directory must be configured for smart cards.

To configure a L2TP/IPsec VPN for clients using smart cards and IKEv1, ensure that the following settings are configured:

1. On a RADIUS server, you must configure a remote access policy to allow EAP authentication for smart card users and select a server certificate. The user entry in Microsoft Active Directory must be configured for smart cards. (For detailed information on creating and managing user roles and policies, see ["Roles and Policies" on page 296.](#))
 - Ensure that RADIUS server is part of the server group used for VPN authentication.
 - Configure other VPN settings as described in ["Configuring a VPN for L2TP/IPsec with IKEv2 in the WebUI" on page 279](#), while selecting the following options:
 - Select **Enable L2TP**
 - Select **EAP** for the Authentication Protocol.
 - Define an IKE Shared Secret to be used for machine authentication. (To make the IKE key global, specify 0.0.0.0 and 0.0.0.0 for both subnet and subnet mask).
 - Configure the IKE policy for **Pre-Share** authentication.

Configuring a VPN for Clients with User Passwords

This section describes how to configure a remote access VPN on the controller for L2TP/IPsec clients with user passwords. As described previously in this section, L2TP/IPsec requires two levels of authentication: first, IKE SA authentication, and then user-level authentication with the PAP authentication protocol. IKE SA is authenticated with a preshared key, which you must configure as an IKE shared secret on the controller. User-level authentication is performed by the controller's internal database.

On the controller, you need to configure the following:

- AAA database entries for username and passwords
- VPN authentication profile which defines the internal server group and the default role assigned to authenticated clients
- L2TP/IPsec VPN with PAP as the PPP authentication (IKEv1 only).
- (For IKEv1 clients) An IKE policy for preshared key authentication of the SA.
- (For IKEv2 clients) A server certificate to authenticate the controller to clients and a CA certificate to authenticate VPN clients.

In the WebUI

Use the following procedure to configure L2TP/IPsec VPN for username/password clients via the WebUI:

1. Navigate to the **Configuration > Security > Authentication > Servers** window.

- a. Select **Internal DB** to display entries for the internal database.
 - b. Click **Add User**.
 - c. Enter username and password information for the client.
 - d. Click **Enabled** to activate this entry on creation.
 - e. Click **Apply**.
2. Navigate to the **Configuration > Security > Authentication > L3 Authentication** window.
 - a. Under default VPN Authentication Profile, select **Server Group**.
 - b. Select the **internal** server group from the drop-down menu.
 - c. Click **Apply**.
 3. Navigate to the **Configuration > Advanced Services > VPN Services > IPsec** window.
 - a. Select **Enable L2TP** (this is enabled by default).
 - b. Select **PAP** for Authentication Protocols.
 4. Configure other VPN settings as described in ["Configuring a VPN for L2TP/IPsec with IKEv2 in the WebUI" on page 279](#), while ensuring that the following settings are selected:
 - In the **L2TP and XAUTH Parameters** section of the **Configuration>VPN Services>IPsec** tab, enable **L2TP**.
 - In the **L2TP and XAUTH Parameters** section of the **Configuration>VPN Services>IPsec** tab, select **PAP** as the authentication protocol.

In the CLI

The following example uses the command-line interface to configure a L2TP/IPsec VPN for username/password clients using IKEv1.

```
(host) (config) #vpdn group l2tp
    enable
    ppp authentication pap
    client dns 101.1.1.245

(host) (config) #ip local pool pw-clients 10.1.1.1 10.1.1.250

(host) (config) #crypto isakmp key <key> address 0.0.0.0 netmask 0.0.0.0

(host) (config) #crypto isakmp policy 1
    authentication pre-share
```

Next, issue the following command in *enable* mode to configure client entries in the internal database:

```
(host) (config) #local-userdb add username <name> password <password>
```

Configuring Remote Access VPNs for XAuth

Extended Authentication (XAuth) is an Internet Draft that allows user authentication after IKE Phase 1 authentication. This authentication prompts the user for a username and password, with user credentials authenticated with an external RADIUS or LDAP server or the controller's internal database. Alternatively, the user can start the client authentication with a smart card which contains a digital certificate to verify the client credentials. IKE Phase 1 authentication can be done with either an IKE preshared key or digital certificates.

Configuring VPNs for XAuth Clients using Smart Cards

This section describes how to configure a remote access VPN on the controller for Cisco VPN XAuth clients using smart cards. (A smart card contains a digital certificate which allows user-level authentication without the user entering a username and password.) IKE Phase 1 authentication can be done with either an IKE preshared key or

digital certificates; for XAuth clients using smart cards, the smart card digital certificates must be used for IKE authentication. The client is authenticated with the internal database on the controller.

On the controller, you need to configure the following:

1. Add entries for Cisco VPN XAuth clients to the controller's internal database, or to an external RADIUS

 NOTE: For each client, you need to create an entry in the internal database with the entire Principal name (SubjectAltname in X.509 certificates) or Common Name as it appears on the certificate.

1. or LDAP server. For details on configuring an authentication server, see ["Authentication Servers" on page 168](#)
2. Verify that the server with the client data is part of the server group associated with the VPN authentication profile.
3. In the **L2TP and XAUTH Parameters** section of the **Configuration > VPN Services > IPsec** tab, enable L2TP.
4. In the **L2TP and XAUTH Parameters** section of the **Configuration > VPN Services > IPsec** tab, enable XAuth to enable prompting for the username and password.
5. The Phase 1 IKE exchange for XAuth clients can be either **Main Mode** or **Aggressive Mode**. Aggressive Mode condenses the IKE SA negotiations into three packets (versus six packets for Main Mode). In the **Aggressive Mode** section of the **Configuration > VPN Services > IPsec** tab, Enter the authentication group name for aggressive mode to associate this setting to multiple clients. Make sure that the group name matches the aggressive mode group name configured in the VPN client software.
6. Configure other VPN settings as described in ["Configuring a VPN for L2TP/IPsec with IKEv2 in the WebUI" on page 279](#), while ensuring that the following settings are selected
 - In the **L2TP and XAUTH Parameters** section of the **Configuration > VPN Services > IPSEC** tab, enable L2TP.
 - In the **L2TP and XAUTH Parameters** section of the **Configuration > VPN Services > IPSEC** tab, enable XAuth to enable prompting for the username and password.
 - Define an IKE policy to use **RSA** or **ECDSA** authentication.

The following example describes the steps to use the command-line interface to configure a VPN for Cisco Smart Card Clients using certificate authentication and IKEv1, where the client is authenticated against user entries added to the internal database:

```
(host) (config) #aaa authentication vpn default
server-group internal

(host) (config) #no crypto-local isakmp xauth

(host) (config) #vpdn group l2tp
enable
client dns 101.1.1.245

(host) (config) #ip local pool sc-clients 10.1.1.1 10.1.1.250

(host) (config) #crypto-local isakmp server-certificate MyServerCert
(host) (config) #crypto-local isakmp ca-certificate TrustedCA

(host) (config) #crypto isakmp policy 1
authentication rsa-sig
```

Enter the following command in enable mode to configure client entries in the internal database:

```
(host) (config) #local-userdb add username <name> password <password>
```

Configuring a VPN for XAuth Clients Using a Username and Password

This section describes how to configure a remote access VPN on the controller for Cisco VPN XAuth clients using passwords. IKE Phase 1 authentication is done with an IKE preshared key; the user is then prompted to enter their username and password which is verified with the internal database on the controller.

On the controller, you need to configure the following:

1. Add entries for Cisco VPN XAuth clients to the controller's internal database, For details on configuring an authentication server, see ["Authentication Servers" on page 168](#)



NOTE: For each client, you need to create an entry in the internal database with the entire Principal name (SubjectAltname in X.509 certificates) or Common Name as it appears on the certificate.

2. Verify that the server with the client data is part of the server group associated with the VPN authentication profile.
3. Configure other VPN settings as described in ["Configuring a VPN for L2TP/IPsec with IKEv2 in the WebUI" on page 279](#), while ensuring that the following settings are selected:
 - In the **L2TP and XAUTH Parameters** section of the **Configuration > VPN Services > IPSEC** tab, enable L2TP.
 - In the **L2TP and XAUTH Parameters** section of the **Configuration > VPN Services > IPSEC** tab, enable XAuth to enable prompting for the username and password.
 - The IKE policy must have **pre-shared** authentication.

The following example configures a VPN for XAuth IKEv1 clients using a username and passwords. Access the command-line interface and issue the following commands in config mode:

```
(host) (config) #aaa authentication vpn default
server-group internal

crypto-local isakmp xauth

(host) (config) #vpdn group l2tp
enable
client dns 101.1.1.245

(host) (config) #ip local pool pw-clients 10.1.1.1 10.1.1.250

(host) (config) #crypto isakmp key 0987654 address 0.0.0.0 netmask 0.0.0.0

(host) (config) #crypto isakmp policy 1
authentication pre-share
```

Enter the following command in enable mode to configure client entries in the internal database:

```
(host) (config) #local-userdb add username <name> password <password>
```

Working with Remote Access VPNs for PPTP

Point-to-Point Tunneling Protocol (PPTP) is an alternative to L2TP/IPsec. Like L2TP/IPsec, PPTP provides a logical transport mechanism to send PPP frames as well as tunneling or encapsulation so that the PPP frames can be sent across an IP network. PPTP relies on the PPP connection process to perform user authentication and protocol configuration.

With PPTP, data encryption begins after PPP authentication and connection process is completed. PPTP connections use Microsoft Point-to-Point Encryption (MPPE), which uses the Rivest-Shamir-Aldeman (RSA) RC-4 encryption algorithm. PPTP connections require user-level authentication through a PPP-based authentication protocol (MSCHAPv2 is the currently-supported method).

In the WebUI

1. Navigate to the **Configuration > Advanced Services > VPN Services > PPTP** page.
2. To enable PPTP, select **Enable PPTP**.
3. Select either **MSCHAP** or **MSCHAPv2** as the authentication protocol.
4. Configure IP addresses of the primary and secondary DNS servers.
5. Configure the primary and secondary WINS Server IP addresses that are pushed to the VPN Dialer.
6. Configure the VPN Address Pool.
 - a. Click **Add**. The **Add Address Pool** window displays.
 - b. Specify the pool name, start address, and end address.
 - c. Click **Done** on completion to apply the configuration.
7. Click **Apply** to apply the changes made before navigating to other pages.

In the CLI

```
(host) (config) #vpdn group pptp
enable
client configuration {dns|wins} <ipaddr1> [<ipaddr2>]
ppp authentication {mschapv2}
(host) (config) #pptp ip local pool <pool> <start-ipaddr> <end-ipaddr>
```

Working with Site-to-Site VPNs

Site-to-site VPN allows sites at different physical locations to securely communicate with each other over a Layer-3 network such as the Internet. You can use Dell controllers instead of VPN concentrators to connect the sites. Or, you can use a VPN concentrator at one site and a controller at the other site.

The Dell controller supports the following IKE SA authentication methods for site-to-site VPNs:

- Preshared key: Note that the same IKE shared secret must be configured on both the local and remote sites.
- Suite-B cryptographic algorithms
- Digital certificates: You can configure a RSA or ECDSA server certificate and a CA certificate for each site-to-site VPN IPsec map configuration. If you are using certificate-based authentication, the peer must be identified by its certificate subject-name distinguished name (for deployments using IKEv2) or by the peer's IP address (for IKEv1). For more information about importing server and CA certificates into the controller, see [Management Access on page 625](#).



NOTE: Certificate-based authentication is only supported for site-to-site VPN between two Dell controllers with static IP addresses.

Working with Third-Party Devices

Dell controllers can use IKEv1 or IKEv2 to establish a site-to-site VPN between another Dell controller or between that controller and third-party device. Note, however, that only Dell controllers and devices running Windows 2008 Server or Strongswan 4.3 support IKEv2 authentication.

Devices running Windows 2008 server can use Suite-B cryptographic algorithms and IKEv1 to support authentication using RSA or ECDSA. Strongswan 4.3 devices can use IKEv2 to support authentication using RSA or ECDSA certificates, Suite-B cryptographic algorithms, and pre-shared keys.

Working with Site-to-Site VPNs with Dynamic IP Addresses

ArubaOS supports site-to-site VPNs with two statically addressed Dell controllers, or with one static and one dynamically addressed controller. By default, site-to-site VPN uses IKE Main-mode with Pre-Shared-Keys to authenticate the IKE SA. This method uses the IP address of the peer, and therefore does not work for dynamically addressed peers.

To support site-site VPN with dynamically addressed devices, you must enable IKE Aggressive-Mode with Authentication based on a Pre-Shared-Key. The Dell controller with a dynamic IP address must be configured to be the *initiator* of IKE Aggressive-mode for Site-Site VPN, while the controller with a static IP address must be configured as the *responder* of IKE Aggressive-mode.

Understanding VPN Topologies

You must configure VPN settings on the Dell controllers at both the local and remote sites. In the following figure, a VPN tunnel connects Network A to Network B across the Internet.

Figure 78: Site-to-Site VPN Configuration Components

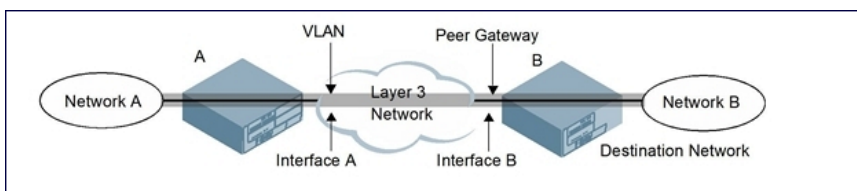

To configure the VPN tunnel on controller A, you need to configure the following:

- The source network (Network A)
- The destination network (Network B)
- The VLAN on which the controller A's interface to the Layer-3 network is located (Interface A in the [Figure 78](#))
- The peer gateway, which is the IP address of controller B's interface to the Layer-3 network (Interface B in the [Figure 78](#))



NOTE: Configure VPN settings on the Dell controllers at both the local and remote sites.

Configuring Site-to-Site VPNs

Use the following procedures to create a site-to-site VPN via the WebUI or command-line interfaces.

In the WebUI

1. Navigate to the **Configuration > Advanced Services > VPN Services > Site-to-Site** page.
2. In the **IPsec Maps** section, click **Add** to open the **Add IPsec Map** window.
3. Enter a name for this VPN connection in the **Name** field.
4. Enter a priority level for the IPsec map. Negotiation requests for security associations try to match the highest-priority map first. If that map does not match, the negotiation request continues down the list to the next-highest priority map until a match is made.

5. In the **Source Network** and **Source Subnet Mask** fields, enter the IP address and netmask for the source (the local network connected to the controller). (See controller A in [Figure 78](#).)
6. In the **Destination Network** and **Destination Subnet Mask** fields, enter the IP address and netmask for the destination (the remote network to which the local network communicates). (See controller B in [Figure 78](#).)
7. If you are using IKEv1 to establish a site-to-site VPN to a statically addressed remote peer, in the **Peer Gateway** field, enter the IP address of the interface used by remote peer to connect to the L3 network. (See Interface B in [Figure 78](#).) If you are configuring an IPsec map for a dynamically addressed remote peer, you must leave the peer gateway set to its default value of 0.0.0.0.
8. If you are using IKEv2 to establish a site-to-site VPN to a statically addressed remote peer, identify the peer device by entering its certificate subject name in the **Peer Certificate Subject Name** field.



NOTE: To identify the subject name of a peer certificate, access the command-line interface and issue the command `show crypto-local pki servercert <certname> subject`

9. The **Security Association Lifetime** parameter defines the lifetime of the security association, in seconds. The default value is 7200 seconds. To change this value, uncheck the **default** checkbox and enter a value from 300 to 86400 seconds.
10. Click the **Version** drop-down list and select **V1** to configure the VPN for IKEv1, or **V2** for IKEv2.
11. Select the **VLAN** that contains the interface of the local controller which connects to the Layer-3 network. (See Interface A in [Figure 78](#).)
This determines the source IP address used to initiate IKE. If you select 0 or None, the default is the VLAN of the controller's IP address (either the VLAN where the loopback IP is configured or VLAN 1 if no loopback IP is configured).
12. If you enable Perfect Forward Secrecy (PFS) mode, new session keys are not derived from previously used session keys. Therefore, if a key is compromised, that compromised key does not affect any previous session keys. PFS mode is disabled by default. To enable this feature, click the **PFS** drop-down list and select one of the following Perfect Forward Secrecy modes:
 - **group1**: 768-bit Diffie Hellman prime modulus group.
 - **group2**: 1024-bit Diffie Hellman prime modulus group.
 - **group19**: 256-bit random Diffie Hellman ECP modulus group.
 - **group20**: 384-bit random Diffie Hellman ECP modulus group.
13. Select **Pre-Connect** to have the VPN connection established even if there is no traffic being sent from the local network. If this is not selected, the VPN connection is only established when traffic is sent from the local network to the remote network.
14. Select **Trusted Tunnel** if traffic between the networks is trusted. If this is not selected, traffic between the networks is untrusted.
15. Select the **Enforce NATT** checkbox to always enforce UDP 4500 for IKE and IPSEC. This option is disabled by default.
16. Add one or more transform sets to be used by the IPsec map. Click the **Transform Set** drop down list, select an existing transform set, then click the arrow button by the drop-down list to add that transform set to the IPsec map.
17. For site-to-site VPNs with dynamically addressed peers, click the **Dynamically Addressed Peers** checkbox.
 - a. Select **Initiator** if the dynamically addressed switch is the *initiator* of IKE Aggressive-mode for Site-Site VPN, or select **Responder** if the dynamically addressed switch is the *responder* for IKE Aggressive-mode.
 - b. In the **FQDN** field, enter a fully qualified domain name (FQDN) for the controller. If the controller is defined as a dynamically addressed responder, you can select **all peers** to make the controller a responder for all VPN

peers, or select **Per Peer ID** and specify the FQDN to make the controller a responder for one specific initiator only.

18. Select an authentication type. For pre-shared key authentication, select **Pre-Shared Key**, then enter a shared secret in the **IKE Shared Secret** and **Verify IKE Shared Secret** fields. This authentication type is required in IPsec maps for a VPN with a dynamically addressed peer.

-or-

For certificate authentication, select **Certificate**, then click the **Server Certificate** and **CA certificate** drop-down lists to select certificates previously imported into the controller. See [Management Access on page 625](#) for more information.

19. Click **Done** to apply the site-to-site VPN configuration.
20. Click **Apply**.
21. Click the **IPSEC** tab to configure an IKE policy.
 - a. Under IKE Policies, click **Add** to open the **IPSEC Add Policy** configuration page.
 - b. Set the **Priority** to 1 for this configuration to take priority over the Default setting.
 - c. Set the **Version** type to match the IKE version you selected in Step 10 above.
 - d. Set the **Encryption** type from the drop-down menu.
 - e. Set the **HASH Algorithm** from the drop-down menu.
 - f. Set the **Authentication** to **PRE-SHARE** if you are using preshared keys. If you are using certificate-based IKE, select **RSA** or **ECDSA**.
 - g. Set the **Diffie Hellman Group** from the drop-down menu.
 - h. The IKE policy selections, including any preshared key, need to be reflected in the VPN client configuration. When using a third party VPN client, set the VPN configuration on clients to match the choices made above. If the Dell dialer is used, you must configure the dialer prior to downloading the dialer onto the local client.
 - i. Click **Done** to activate the changes.
 - j. Click **Apply**.

In the CLI

To use the command-line interface to configure a site-to-site VPN with two static IP Dell controllers using IKEv1, issue the following commands:

```
(host) (config) #crypto-local ipsec-map <name> <priority>
  src-net <ipaddr> <mask>
  dst-net <ipaddr> <mask>
  peer-ip <ipaddr>
  vlan <id>
  version v1|v2
  peer-cert-dn <peer-dn>
  pre-connect enable|disable
  trusted enable
```

For certificate authentication:

```
  set ca-certificate <cacert-name>
  set server-certificate <cert-name>

(host) (config) #crypto isakmp policy <priority>
  encryption {3des|aes128|aes192|aes256|des}
  version v1|v2
  authentication {rsa-sig|ecdsa-256|ecdsa-384}
  group {1|2|19|20}
  hash {md5|sha|sha1-96|sha2-256-128|sha2-384-192}
```

```
lifetime <seconds>
```

For preshared key authentication:

```
(host) (config) #crypto-local isakmp key <key> address <ipaddr> netmask <mask>
```

```
(host) (config) #crypto isakmp policy <priority>
  encryption {3des|aes128|aes192|aes256|des}
  version v1|v2
  authentication pre-share
  group {1|2|19|20}
  hash {md5|sha|sha1-96|sha2-256-128|sha2-384-192}
  lifetime <seconds>
```

To configure site-to-site VPN with a static and a dynamically addressed controller that initiates IKE Aggressive-mode for Site-Site VPN:

```
(host) (config) #crypto-local ipsec-map <name> <priority>
  src-net <ipaddr> <mask>
  dst-net <ipaddr> <mask>
  peer-ip <ipaddr>local-fqdn <local_id_fqdn>
  vlan <id>
  pre-connect enable|disable
  trusted enable
```

For the Pre-shared-key:

```
(host) (config) #crypto-local isakmp key <key> address <ipaddr> netmask 255.255.255.255
```

For a static IP controller that responds to IKE Aggressive-mode for Site-Site VPN:

```
crypto-local ipsec-map <name2> <priority>
  src-net <ipaddr> <mask>
  dst-net <ipaddr> <mask>
  peer-ip 0.0.0.0
  peer-fqdn fqdn-id <peer_id_fqdn>
  vlan <id>
  trusted enable
```

For the Pre-shared-key:

```
(host) (config) #crypto-local isakmp key <key> fqdn <fqdn-id>
```

For a static IP controller that responds to IKE Aggressive-mode for Site-Site VPN with One PSK for All FQDNs:

```
(host) (config) #crypto-local ipsec-map <name2> <priority>
  src-net <ipaddr> <mask>
  peer-ip 0.0.0.0
  peer-fqdn any-fqdn
  vlan <id>
  trusted enable
```

For the Pre-shared-key for All FQDNs:

```
(host) (config) #crypto-local isakmp key <key> fqdn-any
```

Detecting Dead Peers

Dead Peer Detection (DPD) is enabled by default on the controller for site-to-site VPNs. DPD, as described in RFC 3706, “A Traffic-Based Method of Detecting Dead Internet Key Exchange (IKE) Peers,” uses IPsec traffic patterns to minimize the number of IKE messages required to determine the liveliness of an IKE peer.

To configure DPD parameters, issue the following commands via the command-line interface.

```
(host) (config) #crypto-local isakmp dpd idle-timeout <idle_seconds> retry-timeout <retry_seconds> retry-attempts <number>
```

Understanding Default IKE policies

ArubaOS includes the following default IKE policies. These policies are predefined and cannot be edited.

Table 79: Default IKE Policy Settings

Policy Name	Policy Number	IKE Version	Encryption Algorithm	Hash Algorithm	Authentication Method	PRF Method	Diffie-Hellman Group
Default protection suite	10001	IKEv1	3DES-168	SHA 160	Pre-Shared Key	N/A	2 (1024 bit)
Default RAP Certificate protection suite	10002	IKEv1	AES -256	SHA 160	RSA Signature	N/A	2 (1024 bit)
Default RAP PSK protection suite	10003		AES -256	SHA 160	Pre-Shared Key	N/A	2 (1024 bit)
Default RAP IKEv2 RSA protection suite	10004	IKEv2	AES -256	SSHA160	RSA Signature	hmac-sha1	2 (1024 bit)
Default Cluster PSK protection suite	10005	IKEv1	AES -256	SHA160	Pre-Shared Key	Pre-Shared Key	2 (1024 bit)
Default IKEv2 RSA protection suite	10006	IKEv2	AES - 128	SHA 96	RSA Signature	hmac-sha1	2 (1024 bit)
Default IKEv2 PSK protection suite	10007	IKEv2	AES - 128	SHA 96	Pre-shared key	hmac-sha1	2 (1024 bit)
Default Suite-B 128bit ECDSA protection suite	10008	IKEv2	AES - 128	SHA 256-128	ECDSA-256 Signature	hmac-sha2-256	Random ECP Group (256 bit)
Default Suite-B 256 bit ECDSA protection suite	10009	IKEv2	AES -256	SHA 384-192	ECDSA-384 Signature	hmac-sha2-384	Random ECP Group (384 bit)
Default Suite-B 128bit IKEv1 ECDSA protection suite	10010	IKEv1	AES-GCM-128	SHA 256-128	ECDSA-256 Signature	hmac-sha2-256	Random ECP Group (256 bit)
Default Suite-B 256-bit IKEv1 ECDSA protection suite	10011	IKEv1	AES-GCM-256	SHA 256-128	ECDSA-256 Signature	hmac-sha2-256	Random ECP Group (256 bit)

Working with VPN Dialer

For Windows clients, a dialer can be downloaded from the controller to auto-configure tunnel settings on the client.

Configuring VPN Dialer

Use the following procedures to configure the VPN dialer via the WebUI or command-line interfaces

In the WebUI

1. Navigate to the **Configuration > Advanced Services > VPN Services > Dialers** page. Click **Add** to add a new dialer or click the **Edit** tab to edit an existing dialer.
2. Enter the Dialer Name that is used to identify this setting.
3. Configure the dialer to work with PPTP or L2TP by selecting **Enable PPTP** or **Enable L2TP**.
4. Select the authentication protocol. This should match the L2TP or PPTP authentication type configured for the VPN in the **Configuration > Advanced Services > VPN Services > IPSEC** window.
5. (Optional) Select **Send Direct Network Traffic In Clear** to enable “split tunneling” functionality so that traffic destined for the internal network is tunneled while traffic for the Internet is not.
This option is not recommended for security reasons.
6. (Optional) Select **Disable Wireless Devices When Client is Wired** to allow the dialer to shut down the wireless interface when it detects that a wired network connection is in use.
7. (Optional) Select **Enable SecurID New and Next Pin Mode** to enable site-to-site VPN support for SecurID new and next pin modes.
8. For L2TP:
 - Set the IKE Hash Algorithm to the value defined in the IKE policy on the **Advanced Services > VPN Services > IPSEC** window.
 - If a preshared key is configured for an IKE Shared Secret in the **VPN Services > IPSEC** window, enter the key.
 - The key you enter in the **Dialers** window must match the preshared key configured on the IPsec page.
 - Select the IPsec Mode Group that matches the Diffie Hellman Group configured for the IPsec policy.
 - Select the IPsec Encryption that matches the Encryption configured for the IPsec policy.
 - Select the IPsec Hash Algorithm that matches the Hash Algorithm configured for the IPsec policy.
9. Click **Done** to apply the changes made prior to navigating to another page.

In the CLI

Issue the following commands to configure the VPN dialer via the CLI:

```
(host(config) #vpn-dialer <name>
  enable {dnctclear|l2tp|pptp|secureid_newpinmode|wirednowifi}
  ike authentication {pre-share <key>|rsa-sig}
  ike encryption {3des|des}
  ike group {1|2}
  ike hash {md5|sha}
  ipsec encryption {esp-3des|esp-des}
  ipsec hash {esp-md5-hmac|esp-sha-hmac}
  ppp authentication {cache-secureid|chap|mschap|mschapv2|pap}
```

Assigning a Dialer to a User Role

The VPN dialer can be downloaded using Captive Portal. For the user role assigned through Captive Portal, configure the dialer by the name used to identify the dialer.

For example, if the captive portal client is assigned the *guest* role after logging on through captive portal and the dialer is called *mydialer*, configure *mydialer* as the dialer to be used in the guest role.

In the WebUI

1. Navigate to the **Configuration > Security > Access Control > User Roles** page.
2. Click **Edit** for the user role.
3. Under VPN Dialer, select the dialer you configured and click **Change**.
4. Click **Apply**.

In the CLI

To configure the captive portal dialer for a user role via the command-line interface, access the CLI in config mode and issue the following commands:

```
(host) (config) #user-role <role>  
    dialer <name>
```

Chapter 19

Roles and Policies

The client in a Dell user-centric network is associated with a *user role*, which determines the client's network privileges, how often it must re-authenticate, and which bandwidth contracts are applicable. A *policy* is a set of rules that applies to traffic that passes through the Dell controller. You specify one or more policies for a user role. Finally, you can assign a user role to clients before or after they authenticate to the system.

This chapter describes assigning and creating roles and policies using the ArubaOS CLI or WebUI. Roles and policies can also be configured for WLANs associated with the "default" ap-group via the WLAN Wizard:

Configuration > Wizards > WLAN Wizard. Follow the steps in the workflow pane within the wizard and refer to the help tab for assistance.

Topics in this chapter include:

- "Configuring Firewall Policies" on page 296
- "Creating a Firewall Policy" on page 297
- "Creating a Network Service Alias" on page 300
- "Creating an ACL White List" on page 300
- "Creating User Roles" on page 302
- "Assigning User Roles" on page 305
- "Understanding Global Firewall Parameters" on page 310



NOTE: This chapter describes configuring firewall policies and parameters that relate to IPv4 traffic. See [IPv6 Support on page 128](#) for information about configuring IPv6 firewall policies and parameters.

Configuring Firewall Policies

A firewall policy identifies specific characteristics about a data packet passing through the Dell controller and takes some action based on that identification. In a Dell controller, that action can be a firewall-type action such as permitting or denying the packet, an administrative action such as logging the packet, or a quality of service (QoS) action such as setting 802.1p bits or placing the packet into a priority queue. You can apply firewall policies to user roles to give differential treatment to different users on the same network, or to physical ports to apply the same policy to all traffic through the port.

Firewall policies differ from access control lists (ACLs) in the following ways:

- Firewall policies are *stateful*, meaning that they recognize flows in a network and keep track of the state of sessions. For example, if a firewall policy permits telnet traffic from a client, the policy also recognizes that inbound traffic associated with that session should be allowed.
- Firewall policies are *bi-directional*, meaning that they keep track of data connections traveling into or out of the network. ACLs are normally applied to either traffic inbound to an interface or outbound from an interface.
- Firewall policies are *dynamic*, meaning that address information in the policy rules can change as the policies are applied to users. For example, the alias *user* in a policy automatically applies to the IP address assigned to a particular user. ACLs typically require static IP addresses in the rule.



NOTE: You can apply IPv4 and IPv6 firewall policies to the same user role. See [IPv6 Support on page 128](#) for information about configuring IPv6 firewall policies.

Working With Access Control Lists (ACLs)

Access control lists (ACLs) are a common way of restricting certain types of traffic on a physical port. ArubaOS provides the following types of ACLs:

- Standard ACLs permit or deny traffic based on the source IP address of the packet. Standard ACLs can be either named or numbered, with valid numbers in the range of 1-99 and 1300-1399. Standard ACLs use a bitwise mask to specify the portion of the source IP address to be matched.
- Extended ACLs permit or deny traffic based on source or destination IP address, source or destination port number, or IP protocol. Extended ACLs can be named or numbered, with valid numbers in the range 100-199 and 2000-2699.
- MAC ACLs are used to filter traffic on a specific source MAC address or range of MAC addresses. Optionally, you can mirror packets to a datapath or remote destination for troubleshooting and debugging purposes. MAC ACLs can be either named or numbered, with valid numbers in the range of 700-799 and 1200-1299.
- Ethertype ACLs are used to filter based on the Ethertype field in the frame header. Optionally, you can mirror packets to a datapath or remote destination for troubleshooting and debugging purposes. Ethertype ACLs can be either named or numbered, with valid numbers in the range of 200-299. These ACLs can be used to permit IP while blocking other non-IP protocols, such as IPX or AppleTalk.
- Service ACLs provide a generic way to restrict how protocols and services from specific hosts and subnets to the controller are used. Rules with this ACL are applied to all traffic on the controller regardless of the ingress port or VLAN.

ArubaOS provides both standard and extended ACLs for compatibility with router software from popular vendors, however firewall policies provide equivalent and greater function than standard and extended ACLs and should be used instead.

You can apply MAC and Ethertype ACLs to a user role, however these ACLs only apply to non-IP traffic *from* the user.

Support for Desktop Virtualization Protocols

ArubaOS supports desktop virtualization protocols by providing preconfigured ACLs for Citrix and VMware clients. You can apply these ACLs to the user-role when using the Virtual Desktop Infrastructure (VDI) clients. This ensures that any enterprise application that uses the VDI client performs optimally with appropriate QoS.



NOTE: Disable the voice aware ARM when applying the ACLs for the VDI clients as the virtual desktop sessions may prevent the ARM scanning.

Creating a Firewall Policy

This section describes how to configure the rules that constitute a firewall policy. A firewall policy can then be applied to a user role (until the policy is applied to a user role, it does not have any effect).

[Table 80](#) describes required and optional parameters for a rule.

Table 80: Firewall Policy Rule Parameters

Field	Description
Source (required)	<p>Source of the traffic, which can be one of the following:</p> <ul style="list-style-type: none"> any: Acts as a wildcard and applies to any source address. user: This refers to traffic from the wireless client. host: This refers to traffic from a specific host. When this option is chosen, you must configure the IP address of the host. network: This refers to a traffic that has a source IP from a subnet of IP addresses. When this option is chosen, you must configure the IP address and network mask of the subnet. alias: This refers to using an alias for a host or network. You configure the alias by navigating to the Configuration > Advanced Services > Stateful Firewall > Destination page.
Destination (required)	<p>Destination of the traffic, which can be configured in the same manner as Source.</p>
Service (required)	<p>Type of traffic, which can be one of the following:</p> <ul style="list-style-type: none"> any: This option specifies that this rule applies to any type of traffic. tcp: Using this option, you configure a range of TCP port(s) to match for the rule to be applied. udp: Using this option, you configure a range of UDP port(s) to match for the rule to be applied. service: Using this option, you use one of the pre-defined services (common protocols such as HTTPS, HTTP, and others) as the protocol to match for the rule to be applied. You can also specify a network service that you configure by navigating to the Configuration > Advanced Services > Stateful Firewall > Network Services page. protocol: Using this option, you specify a different layer 4 protocol (other than TCP/UDP) by configuring the IP protocol value.
Action (required)	<p>The action that you want the controller to perform on a packet that matches the specified criteria. This can be one of the following:</p> <ul style="list-style-type: none"> permit: Permits traffic matching this rule. drop: Drops packets matching this rule without any notification. reject: Drops the packet and sends an ICMP notification to the traffic source. src-nat: Performs network address translation (NAT) on packets matching the rule. When this option is selected, you need to select a NAT pool. (If this pool is not configured, you configure a NAT pool by navigating to the Configuration > Advanced > Security > Advanced > NAT Pools). Source IP changes to the outgoing interface IP address (implied NAT pool) or from the pool configured (manual NAT pool). This action functions in tunnel/decrypt-tunnel forwarding mode. dst-nat: This option redirects traffic to the configured IP address and destination port. An example of this option is to redirect all HTTP packets to the captive portal port on the Dell controller as used in the pre-defined policy called "captiveportal". This action functions in tunnel/decrypt-tunnel forwarding mode. User should configure the NAT pool in the controller. dual-nat: This option performs both source and destination NAT on packets matching the rule. Forward packets from source network to destination; re-mark them with destination IP of the target network. This action functions in tunnel/decrypt-tunnel forwarding mode. User should configure the NAT pool in the controller. redirect to tunnel: This option redirects traffic into a GRE tunnel. This option is used primarily to redirect all guest traffic into a GRE tunnel to a DMZ router/switch. redirect to ESI group: This option redirects traffic to the specified ESI server group. You also specify the direction of traffic to be redirected: forward, reverse, or both directions. route: Specify the next hop to which packets are routed, which can be one of the following: <ul style="list-style-type: none"> dst-nat: Destination IP changes to the IP configured from the NAT pool. This action functions in bridge/split-tunnel forwarding mode. User should configure the NAT pool in the controller. src-nat: Source IP changes to RAP's external IP. This action functions in bridge/split-tunnel forwarding mode and uses implied NAT pool.
Log (optional)	<p>Logs a match to this rule. This is recommended when a rule indicates a security breach, such as a data packet on a policy that is meant only to be used for voice calls.</p>

Field	Description
Mirror (optional)	Mirrors session packets to datapath or remote destination.
Queue (optional)	The queue in which a packet matching this rule should be placed. Select High for higher priority data, such as voice, and Low for lower priority traffic.
Time Range (optional)	Time range for which this rule is applicable. Configure time ranges on the Configuration > Security > Access Control > Time Ranges page.
Pause ARM Scanning (optional)	Pause ARM scanning while traffic is present. Note that you must enable "VoIP Aware Scanning" in the ARM profile for this feature to work.
Black List (optional)	Automatically blacklists a client that is the source or destination of traffic matching this rule. This option is recommended for rules that indicate a security breach where the blacklisting option can be used to prevent access to clients that are attempting to breach the security.
White List (optional)	A rule must explicitly permit a traffic session before it is forwarded to the controller. The last rule in the white list denies everything else. Configure white list ACLs on the Configuration > Advanced Services > Stateful Firewall > White List (ACL) page.
TOS (optional)	Value of type of service (TOS) bits to be marked in the IP header of a packet matching this rule when it leaves the controller.
802.1p Priority (optional)	Value of 802.1p priority bits to be marked in the frame of a packet matching this rule when it leaves the controller.

The following example creates a policy 'web-only' that allows web (HTTP and HTTPS) access.

In the WebUI

1. Navigate to the **Configuration > Security > Access Control > Policies** page on the WebUI.
2. To configure a firewall policy, select the policy type from the Policies title bar. You can select **All**, **IPv4 Session**, **IPv6 Session**, **Ethernet**, **MAC**, **Standard** or **Extended**.
3. Click **Add** to create a new policy.
4. If you selected **All** in Step 2, then select the type of policy you are adding from the **Policy Type** drop-down menu.
5. Click **Add** to add a rule that allows HTTP traffic.
 - a. Under Service, select service from the drop-down list.
 - b. Select svc-http from the scrolling list.
 - c. Click **Add**.
6. Click **Add** to add a rule that allows HTTPS traffic.
 - a. Under Service, select service from the drop-down list.
 - b. Select svc-https from the scrolling list.
 - c. Click **Add**.



NOTE: Rules can be re-ordered by using the up and down buttons provided for each rule.

7. Click **Apply** to apply this configuration. The policy is not created until the configuration is applied.

In the CLI

```
(host) (config) #ip access-list session web-only
```

```
any any svc-http permit
any any svc-https permit
```

Creating a Network Service Alias

A network service alias defines a TCP, UDP or IP protocol and a list or range of ports supported by that service. When you create a network service alias, you can use that alias when specifying the network service for multiple session ACLs.

In the WebUI

1. Navigate to the **Configuration > Advanced Services > Stateful Firewall > Network Services** page on the WebUI.
2. Click **Add** to create a new alias.
3. Enter a name for the alias in the **Service Name** field.
4. In the **Protocol** section, select either TCP or UDP, or select Protocol and enter the IP protocol number of the protocol for which you want to create an alias.
5. In the **Port Type** section, specify whether you want to define the port by a contiguous range of ports, or by a list of non-contiguous port numbers.
 - If you selected **Range**, enter the starting and ending port numbers in the **Starting Port** and **End Port** fields.
 - If you selected list, enter a comma-separated list of port numbers.
6. To limit the service alias to a specific application, click the **Application Level Gateway (ALG)** drop-down list and select one of the following service types
 - dhcp: Service is DHCP
 - dns: Service is DNS
 - ftp: Service is FTP
 - h323: Service is H323
 - noe: Service is Alcatel NOE
 - rtsp: Service is RTSP
 - sccp: Service is SCCP
 - sip: Service is SIP
 - sips: Service is Secure SIP
 - svp: Service is SVP
 - tftp: Service is TFTP
 - vocera: Service is VOCERA
7. Click **Apply** to save your changes.

In the CLI

To define a service alias via the command-line interface, access the CLI in config mode and issue the following command:

```
(host) (config) #netSERVICE <name> <protocol>|tcp|udp {list <port>,<port>}|<port> [<port>]}
[ALG <service>]
```

Creating an ACL White List

The ACL White List consists of rules that explicitly permit or deny session traffic from being forwarded to or blocked from the controller. The white list protects the controller during traffic session processing by prohibiting

traffic from being automatically forwarded to the controller if it was not specifically denied in a blacklist. The maximum number of entries allowed in the ACL White List is 64. To create an ACL white list, you must first define a white list bandwidth contract, and then assign it to an ACL.

In the WebUI

1. Navigate to the **Configuration > Advanced Services > Stateful Firewall > White List BW Contracts** page.
2. Click **Add** to create a new contract.
3. In the **White list contract name** field, enter the name of a bandwidth contract.
4. The **Bandwidth Rate** field allows you to define a bandwidth rate in either kbps or Mbps. Enter a rate value the **Bandwidth rate** field, then click the drop-down list and select either kbps or Mbps.
5. Click **Done**.

Configuring the ACL White List in the WebUI

1. Navigate to the **Configuration > Stateful Firewall > ACL White List** page.
2. To add an entry, click the **Add** button at the bottom of the page. The **Add New Protocol** section displays.
3. Click the **Action** drop-down list and select **Permit** or **Deny**. **Permit** allows session traffic to be forwarded to the controller while **Deny** blocks session traffic.
4. In the **IP Protocol Number** field, enter the number for a protocol used by session traffic.
5. In the **Starting Ports** field, enter a starting port. This is the first port, in the port range, on which permitted or denied session traffic is running. Port range: 1–65535.
6. In the **End Ports** field, enter an ending port. This is the last port, in the port range, on which permitted or denied session traffic is running. Port range: 1–65535.
7. (Optional) Click the **White list Bandwidth Contract** drop-down list and specify the name of a bandwidth contract to apply to the session traffic. For further information on creating Bandwidth Contracts, see ["Configuring a Bandwidth Contract in the WebUI" on page 304](#)
8. Click **Done**. The ACL displays on the white list section.
9. To delete an entry, click **Delete** next to the entry you want to delete.
10. Click **Apply** to save changes.

Configuring the White List Bandwidth Contract in the CLI

```
cp-bandwidth-contract <name> {mbits <1..2000>}|{kbits <256..2000000>}
```

Configuring the ACL White List in the CLI

Use the following CLI command to create ACL White Lists.

```
(host) (config) #firewall cp {deny|permit} proto <IP protocol number> ports <start port number> <last port number> [bandwidth-contract <name>]
```

To create a whitelist ACL entry that permits traffic using protocol 6 on ports 5000 through 6000 to be forwarded to the controller:

```
(host) (config-fw-cp) #firewall cp permit proto 6 ports 5000 6000
```

To create a whitelist ACL entry that denies traffic using protocol 2 on port 5000 from being forwarded to the controller:

```
(host) (config-fw-cp) #firewall cp deny proto 2 ports 5000 5000
```

Creating User Roles

This section describes how to create a new user role. When you create a user role, you specify one or more policies for the role.

Table 81 describes the different parameters you can configure for the user role.

Table 81: User Role Parameters

Field	Description
Firewall Policies (required)	<p>One or more policies that define the privileges of a wireless client in this role. There are three ways to add a firewall policy to a user role:</p> <ul style="list-style-type: none"> Choose from configured policies (see "Creating a Firewall Policy" on page 297): Select a policy from the list of configured policies and click the "Done" button to add the policy to the list of policies in the user role. If this policy is to be applied to this user role only for specific AP groups, you can specify the applicable AP group. Create a new policy from a configured policy: This option can be used to create a new policy that is derived from an existing policy. Create a new policy: The rules for the policy can be added as explained in "Creating a Firewall Policy" on page 297.
Re-authentication Interval (optional)	<p>Time, in minutes, after which the client is required to reauthenticate. Enter a value between 0-4096. 0 disables reauthentication. Default: 0 (disabled)</p>
Role VLAN ID (optional)	<p>By default, a client is assigned a VLAN on the basis of the ingress VLAN for the client to the controller. You can override this assignment and configure the VLAN ID that is to be assigned to the user role. You configure a VLAN by navigating to the Configuration > Network > VLANs page.</p>
Bandwidth Contract (optional)	<p>You can assign a bandwidth contract to provide an upper limit to upstream or downstream bandwidth utilized by clients in this role. You can select the Per User option to apply the bandwidth contracts on a per-user basis instead of to all clients in the role. For more information, see "Bandwidth Contracts" on page 303.</p>
VPN Dialer (optional)	<p>This assigns a VPN dialer to a user role. For details about VPN dialer, see Virtual Private Networks on page 271. Select a dialer from the drop-down list and assign it to the user role. This dialer will be available for download when a client logs in using captive portal and is assigned this role.</p>
L2TP Pool (optional)	<p>This assigns an L2TP pool to the user role. For more details about L2TP pools, see Virtual Private Networks on page 271. Select the required L2TP pool from the list to assign to the user role. The inner IP addresses of VPN tunnels using L2TP will be assigned from this pool of IP addresses for clients in this user role.</p>
PPTP Pool (optional)	<p>This assigns a PPTP pool to the user role. For more details about PPTP pools, see Virtual Private Networks on page 271. Select the required PPTP pool from the list to assign to the user role. The inner IP addresses of VPN tunnels using PPTP will be assigned from this pool of IP addresses for clients in this user role.</p>
Captive Portal Profile (optional)	<p>This assigns a Captive Portal profile to this role. For more details about Captive Portal profiles, see Captive Portal Authentication on page 233.</p>
Max Sessions	<p>This configures a maximum number of sessions per user in this role. The default is 65535. You can configure any value between 0-65535.</p>

Creating a User Role

The following example creates the user role 'web-guest' and assigns the previously-configured 'web-only' policy to this user role.

In the WebUI

1. Navigate to the **Configuration > Security > Access Control > User Roles** page.
2. Click **Add** to create and configure a new user role.
3. Enter web-guest for Role Name.
4. Under Firewall Policies, click **Add**. From Choose from Configured Policies, select the 'web-only' session policy from the list. You can click **Create** to create and configure a new policy.
5. Click **Done** to add the policy to the user role.



NOTE: If there are multiple policies for this role, policies can be re-ordered by the using the up and down buttons provided for each policy.

6. You can optionally enter configuration values as described in [Table 81](#).
7. Click **Apply** to apply this configuration. The role is not created until the configuration is applied.

After assigning the user role (see "[Assigning User Roles](#)" on page 305), you can click the Show Reference button to see the profiles that reference this user role.

To a delete a user role in the WebUI:

1. Navigate to the **Configuration > Security > Access Control > User Roles** page.
2. Click the **Delete** button against the role you want to delete.



NOTE: You cannot delete a user-role that is referenced to profile or server derived role. Deleting a server referenced role will result in an error. Remove all references to the role and then perform the delete operation.

In the CLI

```
(host) (config) #user-role web-guest
access-list session web-only position 1
```

After assigning the user role (see "[Assigning User Roles](#)" on page 305), you can use the `show reference user-role <role>` command to see the profiles that reference this user role.

Bandwidth Contracts

You can manage bandwidth utilization by assigning maximum bandwidth rates, or *bandwidthcontracts*, to user roles or ap-group. You can configure bandwidth contracts, in kilobits per second (Kbps) or megabits per second (Mbps), for the following types of traffic:

- from the client to the controller ("upstream" traffic)
- from the controller to the client ("downstream" traffic)

You can assign different bandwidth contracts to upstream and downstream traffic for the same user role. You can also assign a bandwidth contract for only upstream or only downstream traffic for a user role; if there is no bandwidth contract specified for a traffic direction, unlimited bandwidth is allowed.

By default, all users that belong to the same role share a configured bandwidth rate for upstream or downstream traffic. You can optionally apply a bandwidth contract on a *per-user* or *per-ap-group* basis; each user who belongs to the role is allowed the configured bandwidth rate.

For example, if clients are connected to the controller through a DSL line, you may want to restrict the upstream bandwidth rate allowed for *each* user to 128 Kbps. Or, you can limit the *total* downstream bandwidth used by all users in the 'guest' role to 128 Mbps. The following example configures a bandwidth rate of 128 Kbps and applies it to upstream traffic for the previously-configured 'web-guest' user role on a per-user basis.

Configuring a Bandwidth Contract in the WebUI

In the WebUI, you can first configure a bandwidth contract and then assign it to a user role:

1. Navigate to the **Configuration > Advanced Services > Stateful Firewall > BW Contracts** page.
2. Click **Add** to create a new contract.
3. In the **Contract Name** field, enter **BC512_up**.
4. The **Bandwidth** field allows you to define a bandwidth rate in either kbps or Mbps. For this example, enter **512** in the **Bandwidth** field, then click the drop-down list and select **kbps**.
5. Click **Done**.

Assigning a Bandwidth Contract to a User Role in the WebUI

Now that you have a defined bandwidth contract, you can assign that contract to a user role.

1. Navigate to the **Configuration > Security > Access Control > User Roles** page.
2. Select **Edit** for the web-guest user role.
3. Under **Bandwidth Contract**, select **BC512_up** from the drop-down menu for **Upstream**.
4. Select **Per User**.
5. Scroll to the bottom of the page, and click **Apply**.

You can also can configure the user role and create the bandwidth contract from the **User Roles** page:

1. Navigate to the **Configuration > Security > Access Control > User Roles** page.
2. Select **Edit** for the web-guest user role.
3. In the **Bandwidth Contract** section, click the **Upstream** drop-down list and select **Add New**. The **New Bandwidth Contract** fields appear.
 - a. In the **Name** field, enter **BC512_up**.
 - b. In the **Bandwidth** field, enter **512**.
 - c. Click the **Bandwidth** drop-down list and select **kbps**.
 - d. Click **Done** to add the new contract and assign it to the role. The **New Bandwidth Contract** section closes.
4. In the **Bandwidth Contract** section, select the **Per User** checkbox.
5. Scroll to the bottom of the page, and click **Apply**.

Configuring and Assigning Bandwidth Contracts in the CLI

```
(host) (config) #aaa bandwidth-contract BC512_up kbps 512
user-role web-guest
bw-contract BC512_up per-user upstream
```

Bandwidth Contract Exceptions

Bandwidth contracts on a VLAN can limit broadcast and multicast traffic. ArubaOS includes an internal exception list to allow broadcast and multicast traffic using the VRRP, LACP, OSPF, PVST and STP protocols. To remove per-vlan bandwidth contract limits on an additional broadcast or multicast protocol, add the MAC address for that broadcast/multicast protocol to the Vlan Bandwidth Contracts MAC Exception List.

Viewing the Current Exceptions List

To view the current bandwidth contract exception list, access the command-line interface in enable mode and issue the command `show vlan-bwcontract-explist`. To view the preconfigured internal bandwidth contract exception list, include the optional `internal` parameter, as shown in the example below:

```
(host) (config) #show vlan-bwcontract-explist internal
Vlan Bw Contracts Internal Mac Exception List
-----
Mac address
-----
01:80:C2:00:00:00
01:00:0C:CC:CC:CD
01:80:C2:00:00:02
01:00:5E:00:82:11
```

Configuring Bandwidth Contract Exceptions

To add the MAC address of a protocol to the exception list for bandwidth contracts, access the command-line interface in config mode and issue the command `vlan-bwcontract-explist <mac-addr>`.

The following example adds the MAC address for CDP (Cisco Discovery Protocol) and VTP (Virtual Trunking Protocol) to the list of protocols that are not limited by VLAN bandwidth contracts.

```
(host) (config) #vlan-bwcontract-explist mac 01:00:0C:CC:CC:CC
```

Assigning User Roles

A client is assigned a user role by one of several methods. A role assigned by one method may take precedence over one assigned by a different method. The methods of assigning user roles are, from lowest to highest precedence:

1. The initial user role or VLAN for unauthenticated clients is configured in the AAA profile for a virtual AP (see [Access Points \(APs\) on page 393](#)).
2. The user role can be derived from user attributes upon the client's association with an AP (this is known as a *user-derived role*). You can configure rules that assign a user role to clients that match a certain set of criteria. For example, you can configure a rule to assign the role `VoIP-Phone` to any client that has a MAC address that starts with bytes `xx:yy:zz`. User-derivation rules are executed *before* client authentication.
3. The user role can be the default user role configured for an authentication method, such as 802.1x or VPN. For each authentication method, you can configure a default role for clients who are successfully authenticated using that method.
4. The user role can be derived from attributes returned by the authentication server and certain client attributes (this is known as a *server-derived role*). If the client is authenticated via an authentication server, the user role for the client can be based on one or more attributes returned by the server during authentication, or on client attributes such as SSID (even if the attribute is not returned by the server). Server-derivation rules are executed *after* client authentication.
5. The user role can be derived from Dell Vendor-Specific Attributes (VSA) for RADIUS server authentication. A role derived from a Dell VSA takes precedence over any other user roles.

The following sections describe the methods of assigning user roles.

Assigning User Roles in AAA Profiles

An AAA profile defines the user role for unauthenticated clients (initial role) as well as the default user role for MAC and 802.1x authentication. To configure user roles in the AAA profile:

In the WebUI

1. Navigate to the **Configuration > Security > Authentication > AAA Profiles** page.
2. Select the default profile or a user-defined AAA profile.
3. Click the **Initial Role** drop-down list, and select the desired user role for unauthenticated users.
4. Click the **802.1x Authentication Default Role** drop-down list and select the desired user role for users who have completed 802.1x authentication.
5. Click the **MAC Authentication Default Role** drop-down list and select the desired user role for clients who have completed MAC authentication.
6. Click **Apply**.

In the CLI

```
(host) (config) #aaa profile <profile>
    initial-role <role>
    d>ot1x-default-role <role>
    mac-default-role <role>
```

For additional information on creating AAA profiles, see ["AAA Profile Parameters" on page 319](#).

Working with User-Derived VLANs

Attributes derived from the client's association with an AP can be used to assign the client to a specific role or VLAN, as user-derivation rules are executed before the client is authenticated.

You configure the user role or VLAN to be assigned to the client by specifying condition rules; when a condition is met, the specified user role or VLAN is assigned to the client. You can specify more than one condition rule; the order of rules is important as the first matching condition is applied. You can optionally add a description of the user rule.

[Table 82](#) describes the conditions for which you can specify a user role or VLAN.

Table 82: *Conditions for a User-Derived Role or VLAN*

Rule Type	Condition	Value
BSSID: Assign client to a role or VLAN based upon the BSSID of AP to which client is associating.	One of the following: <ul style="list-style-type: none">● contains● ends with● equals● does not equal● starts with	MAC address (xx:xx:xx:xx:xx:xx)
DHCP-Option: Assign client to a role or VLAN based upon the DHCP signature ID.	One of the following: <ul style="list-style-type: none">● equals● starts with	DHCP signature ID. NOTE: This string is <i>not</i> case sensitive.
DHCP-Option-77: Assign client to a role or VLAN based upon the user class identifier returned by DHCP server.	equals	string
Encryption: Assign client to a role or VLAN based upon the encryption type used by the client.	One of the following: <ul style="list-style-type: none">● equals● does not equal	<ul style="list-style-type: none">● Open (no encryption)● WPA/WPA2 AES● WPA-TKIP (static or dynamic)● Dynamic WEP● WPA/WPA2 AES PSK

Rule Type	Condition	Value
		<ul style="list-style-type: none"> Static WEP xSec
ESSID: Assign client to a role or VLAN based upon the ESSID to which the client is associated	One of the following: <ul style="list-style-type: none"> contains ends with equals does not equal starts with value of (does not take <i>string</i>; attribute value is used as role) 	string
Location: Assign client to a role or VLAN based upon the ESSID to which the client is associated	One of the following: <ul style="list-style-type: none"> equals does not equal 	string
MAC address of the client	One of the following: <ul style="list-style-type: none"> contains ends with equals does not equal starts with 	MAC address (xx:xx:xx:xx:xx:xx)

Understanding Device Identification

The device identification feature allows you to assign a user role or VLAN to a specific device type by identifying a DHCP option and signature for that device. If you create a user rule with the **DHCP-Option** rule type, the first two characters in the **Value** field must represent the hexadecimal value of the DHCP option that this rule should match, while the rest of the characters in the **Value** field indicate the DHCP signature the rule should match. To create a rule that matches DHCP option 12 (host name), the first two characters of the in the **Value** field must be the hexadecimal value of 12, which is 0C. To create a rule that matches DHCP option 55, the first two characters in the **Value** field must be the hexadecimal value of 55, which is 37.

The following table describes some of the DHCP options that are useful for assigning a user role or VLAN.

DHCP Option values

DHCP Option	Description	Hexadecimal Equivalent
12	Host name	0C
55	Parameter Request List	37
60	Vendor Class Identifier	3C
81	Client FQDN	51

The device identification features in ArubaOS can also automatically identify different client device types and operating systems by parsing the User-Agent strings in the client's HTTP packets. To enable this feature, select the **Device Type Classification** option in the AP's AAA profile. For details, see ["Device Type Classification" on page 319](#).

Configuring a User-derived VLAN in the WebUI

1. Navigate to the **Configuration > Security > Authentication > User Rules** page.

- Click **Add** to add a new set of derivation rules. Enter a name for the set of rules, and click **Add**. The name appears in the User Rules Summary list.
- In the User Rules Summary list, select the name of the rule set to configure rules.
- Click **Add** to add a rule. For **Set Type**, select the VLAN name or ID from the **VLAN** the drop-down menu. (You can select **VLAN** to create derivation rules for setting the VLAN assigned to a client.)
- Configure the condition for the rule by setting the Rule Type, Condition, Value parameters and optional description of the rule. See [Table 82](#) for descriptions of these parameters.
- Select the role assigned to the client when this condition is met.
- Click **Add**.
- You can configure additional rules for this rule set. When you have added rules to the set, use the up or down arrows in the Actions column to modify the order of the rules. (The first matching rule is applied.)
- Click **Apply**.
- (Optional) If the rule uses the **DHCP-Option** condition, best practices is to enable the **Enforce DHCP** parameter in the AP group's AAA profile, which requires users to complete a DHCP exchange to obtain an IP address. For details on configuring this parameter in an AAA profile, see "[Configuring Authentication](#)" on page 318.

Configuring a User-derived Role or VLAN in the CLI

```
(host) (config) #aaa derivation-rules user <name>
  set role|vlan
  condition bssid|dhcp-option|dhcp-option-77|encryption-type|ssid|location|macaddr
  contains|ends-with|equals|not-equals|starts-with|value-of <string>
  set-value <role>
  position <number>
```

See [Table 82](#) for descriptions of these parameters.

User-Derived Role Example

The example rule shown in [Figure 83](#) below sets a user role for clients whose host name (DHCP option 12) has a value of 6C6170746F70, which is the hexadecimal equivalent of the ASCII string *laptop*. The first two digits in the **Value** field are the hexadecimal value of 12 (which is 0C), followed by the specific signature to be matched.



NOTE: There are many online tools available for converting ASCII text to a hexadecimal string.

Figure 83: DHCP Option Rule

Rules-set: Device-Rule				
Priority	Attribute	Operation	Operand	Action
None found				
Add new rules				
Set Type			Role	
Rule Type			DHCP-Option	
Condition			equals	
Value			0C6C6170746F70	
Roles			laptop-role	
Description			role for DHCP option 12	
<input type="button" value="Add"/> <input type="button" value="Cancel"/>				

To identify DHCP strings used by an individual device, access the command-line interface in config mode and issue the following command to include DHCP option values for DHCP-DISCOVER and DHCP-REQUEST frames in

the controller's log files:

logging level debugging network process dhcpd

Now, connect the device you want to identify to the network, and issue the CLI command `show log network`. The sample below is an example of the output that may be generated by this command.

```
(host)(config) #show log network all | include DISCOVER
Feb 26 02:50:34 :202534: <DBG> [dhcpdwrap] [dhcp] Datapath vlan1: DISCOVER 00:19:d2:01:0b:84 Options 74:01
3d:010019d2010b84 0c:736861626172657368612d39393730 3c:4d53465420352e30 37:010f03062c2e2f1f21f92b
Feb 26 02:50:42 :202534: <DBG> [dhcpdwrap] [dhcp] Datapath vlan1: DISCOVER 00:19:d2:01:0b:84 Options 74:01
3d:010019d2010b84 0c:736861626172657368612d39393730 3c:4d53465420352e30 37:010f03062c2e2f1f21f92b
Feb 26 02:50:42 :202534: <DBG> [dhcpdwrap] [dhcp] Datapath vlan1: DISCOVER 00:19:d2:01:0b:84 Options 74:01
3d:010019d2010b84 0c:736861626172657368612d39393730 3c:4d53465420352e30 37:010f03062c2e2f1f21f92b
Feb 26 02:53:03 :202534: <DBG> [dhcpdwrap] [dhcp] Datapath vlan10: DISCOVER 00:26:c6:52:6b:7c Options 74:01
3d:010026c6526b7c 0c:41525542412d46416c73653232 3c:4d53465420352e30 37:010f03062c2e2f1f21f92b 2b:dc0100
...

(host) #show log network all| include REQUEST
Feb 26 02:53:04 :202536: <DBG> [dhcpdwrap] [dhcp] Datapath vlan10: REQUEST 00:26:c6:52:6b:7c reqIP=10.10.10.254
Options 3d:010026c6526b7c 36:0a0a0a02 0c:41525542412d46416c73653232
51:00000041525542412d46416c736532322e73757279612e636f6d 3c:4d53465420352e30 37:010f03062c2e2f1f21f92b 2b:dc0100
Feb 26 02:53:04 :202536: <DBG> [dhcpdwrap] [dhcp] Datapath vlan10: REQUEST 00:26:c6:52:6b:7c reqIP=10.10.10.254
```

Be aware that each device type may not have a unique DHCP fingerprint signature. For example, devices from different manufacturers may use vendor class identifiers that begin with similar strings. If you create a DHCP-Option rule that uses the `starts-with` condition instead of the `equals` condition, the rule may assign a role or VLAN to more than one device type.

Configuring a Default Role for Authentication Method

For each authentication method, you can configure a default role for clients who are successfully authenticated using that method. To configure a default role for an authentication method:

In the WebUI

1. Navigate to the **Configuration > Security > Authentication** page.
2. To configure the default user role for MAC or 802.1x authentication, select the **AAA Profiles** tab. Select the AAA profile. Enter the user role for MAC Authentication Default Role or 802.1x Authentication Default Role.
3. To configure the default user role for other authentication methods, select the **L2 Authentication** or **L3 Authentication** tab. Select the authentication type (Stateful 802.1x or stateful NTLM for L2 Authentication, Captive Portal or VPN for L3 Authentication), and then select the profile. Enter the user role for Default Role.
4. Click **Apply**.

For additional information on configuring captive portal authentication, see ["Captive Portal Authentication" on page 233](#).

In the CLI

To configure the default user role for MAC or 802.1x authentication:

```
(host)(config) #aaa profile <profile>
  mac-default-role <role>
  dot1x-default-role <role>
```

To configure the default user role for other authentication methods:

```
(host)(config) #aaa authentication captive-portal <profile>
  d>default-role <role>
(host)(config) #aaa authentication stateful-dot1x
  d>default-role <role>
(host)(config) #aaa authentication stateful-ntlm
  d>default-role <role>
(host)(config) #aaa authentication vpn
  d>default-role <role>
```

Configuring a Server-Derived Role

If the client is authenticated through an authentication server, the user role for the client can be based on one or more attributes returned by the server during authentication. You configure the user role to be derived by specifying condition rules; when a condition is met, the specified user role is assigned to the client. You can specify more than one condition rule; the order of rules is important as the first matching condition is applied. You can also define server rules based on client attributes such as ESSID, BSSID, or MAC address, even though these attributes are not returned by the server.

For information about configuring a server-derived role, see ["Configuring Server-Derivation Rules" on page 182](#).

Configuring a VSA-Derived Role

Many Network Address Server (NAS) vendors, including Dell, use VSAs to provide features not supported in standard RADIUS attributes. For Dell systems, VSAs can be employed to provide the user role and VLAN for RADIUS-authenticated clients, however the VSAs must be present on your RADIUS server. This involves defining the vendor (Dell) and/or the vendor-specific code (14823), vendor-assigned attribute number, attribute format (such as string or integer), and attribute value in the RADIUS dictionary file. VSAs supported on Dell controllers conform to the format recommended in RFC 2865, "Remote Authentication Dial In User Service (RADIUS)".

Dictionary files that contain Dell VSAs are available on the Dell support website for various RADIUS servers. Log into the Dell support website to download a dictionary file from the Tools folder.

Understanding Global Firewall Parameters

[Table 84](#) describes optional firewall parameters you can set on the controller for IPv4 traffic. To set these options in the WebUI, navigate to the **Configuration > Advanced Services > Stateful Firewall > Global Setting** page and select or enter values in the IPv4 column. To set these options in the CLI, use the `firewall` configuration commands.

See [IPv6 Support on page 128](#) for information about configuring firewall parameters for IPv6 traffic.

Table 84: IPv4 Firewall Parameters

Parameter	Description
Monitor Ping Attack	Number of ICMP pings per second, which if exceeded, can indicate a denial of service attack. Valid range is 1-255 pings per second. Recommended value is 4. Default: No default
Monitor TCP SYN Attack rate	Number of TCP SYN messages per second, which if exceeded, can indicate a denial of service attack. Valid range is 1-255 messages per second. Recommended value is 32. Default: No default
Monitor IP Session Attack	Number of TCP or UDP connection requests per second, which if exceeded, can indicate a denial of service attack. Valid range is 1-255 requests per second. Recommended value is 32. Default: No default
Monitor/Police CP Attack rate (per sec)	Rate of misbehaving user's inbound traffic, which if exceeded, can indicate a denial of service attack. Recommended value is 100 frames per second.
Deny Inter User Bridging	Prevents the forwarding of Layer-2 traffic between wired or wireless users. You can

Parameter	Description
	configure user role policies that prevent Layer-3 traffic between users or networks but this does not block Layer-2 traffic. This option can be used to prevent traffic, such as Appletalk or IPX, from being forwarded. Default: Disabled
Deny Inter User Traffic	Denies traffic between untrusted users by disallowing layer2 and layer3 traffic. This parameter does not depend on the deny-inter-user-bridging parameter being enabled or disabled. Default: Disabled
Deny All IP Fragments	Drops all IP fragments. NOTE: Do not enable this option unless instructed to do so by a Dell representative. Default: Disabled
Enforce TCP Handshake Before Allowing Data	Prevents data from passing between two clients until the three-way TCP handshake has been performed. This option should be disabled when you have mobile clients on the network as enabling this option will cause mobility to fail. You can enable this option if there are no mobile clients on the network. Default: Disabled
Prohibit IP Spoofing	Enables detection of IP spoofing (where an intruder sends messages using the IP address of a trusted client). When this option is enabled, source and destination IP and MAC addresses are checked for each ARP request/response. Traffic from a second MAC address using a specific IP address is denied, and the entry is not added to the user table. Possible IP spoofing attacks are logged and an SNMP trap is sent. Default: Enabled
Prohibit RST Replay Attack	When enabled, closes a TCP connection in both directions if a TCP RST is received from either direction. You should not enable this option unless instructed to do so by a Dell representative. Default: Disabled
Log ICMP Errors	Enables logging of received ICMP errors. You should not enable this option unless instructed to do so by a Dell representative. Default: Disabled
Stateful SIP Processing	Disables monitoring of exchanges between a voice over IP or voice over WLAN device and a SIP server. This option should be enabled only when there is no VoIP or VoWLAN traffic on the network. Default: Disabled (stateful SIP processing is enabled)
Allow Tri-session with DNAT	Allows three-way session when performing destination NAT. This option should be enabled when the controller is <i>not</i> the default gateway for wireless clients and the default gateway is behind the controller. This option is typically used for captive portal configuration. Default: Disabled.
Amsdu Configuration	Enables handling AMSDU traffic from clients. Default: Disabled
Session Mirror Destination	Destination (IP address or port) to which mirrored session packets are sent. This option is used only for troubleshooting or debugging. Packets can be mirrored in multiple ACLs, so only a single copy is mirrored if there is a match within more than one ACL. You can configure the following:

Parameter	Description
	<ul style="list-style-type: none"> Ethertype to be mirrored with the EtherType ACL mirror option. IP flows to be mirrored with the session ACL mirror option. MAC flows to be mirrored with the MAC ACL mirror option. If you configure both an IP address and a port to receive mirrored packets, the IP address takes precedence. Default: N/A
Session Idle Timeout (sec)	Set the time, in seconds, that a non-TCP session can be idle before it is removed from the session table. Specify a value in the range 16-259 seconds. You should not set this option unless instructed to do so by a Dell representative. Default: 15 seconds
Disable FTP Server	Disables the FTP server on the controller. Enabling this option prevents FTP transfers. You should not enable this option unless instructed to do so by a Dell representative. Default: Disabled (FTP server is enabled)
GRE Call ID Processing	Creates a unique state for each PPTP tunnel. You should not enable this option unless instructed to do so by a Dell representative. Default: Disabled
Per-packet Logging	Enables logging of every packet if logging is enabled for the corresponding session rule. Normally, one event is logged per session. If you enable this option, each packet in the session is logged. You should not enable this option unless instructed to do so by a Dell representative, as doing so may create unnecessary overhead on the controller. Default: Disabled (per-session logging is performed)
Broadcast-filter ARP	Reduces the number of broadcast packets sent to VoIP clients, thereby improving the battery life of voice handsets. You can enable this option for voice handsets in conjunction with increasing the DTIM interval on clients. Default: Disabled
Prohibit ARP Spoofing	Detects and prohibits arp spoofing. When this option is enabled, possible arp spoofing attacks are logged and an SNMP trap is sent. Default: Disabled
Prevent DHCP exhaustion	Enable check for DHCP client hardware address against the packet source MAC address. This command checks the frame's source-MAC against the DHCPv4 client hardware address and drops the packet if it does not match. Enabling this feature prevents a client from submitting multiple DHCP requests with different hardware addresses, thereby preventing DHCP pool depletion. Default: Disabled
Session VOIP Timeout (sec)	Sets the idle session timeout for sessions that are marked as voice sessions. If no voice packet exchange occurs over a voice session for the specified time, the voice session is removed. Range is 16 – 300 seconds. Default: 300 seconds
Stateful H.323 Processing	Disables stateful H.323 processing. Default: Enabled
Stateful SCCP Processing	Disables stateful SCCP processing. Default: Disabled
Only allow local subnets in user	Adds only IP addresses, which belong to a local subnet, to the user-table.

Parameter	Description
table	Default: Disabled
Session mirror IPSEC	Configures session mirroring of all frames that are processed by IPsec. Frames are sent to IP address specified by the session-mirror-destination option. NOTE: Use this option for debugging or troubleshooting only. Default: Disabled
Session-tunnel FIB	Enable session,tunnel based forwarding.  <hr/> WARNING: WARNING: Best practices is to enable this parameter only during maintenance window or off-peak production hours. <hr/>
Multicast automatic shaping	Enables multicast optimization and provides excellent streaming quality regardless of the amount of VLANs or IP IGMP groups that are used. Default: Disabled
Stateful VOCERA Processing	Disables stateful VOCERA processing. Default: Disabled
Stateful UA Processing	Disables stateful UA processing. Default: Disabled
Enforce bw contracts for broadcast traffic	Applies bw contracts to local subnet broadcast traffic.
Enforce TCP Sequence numbers	Enforces the TCP sequence numbers for all packets. Default: Disabled
Enforce WMM Voice Priority Matches Flow Content	If traffic to or from the user is inconsistent with the associated QoS policy for voice, the traffic is reclassified to best effort and data path counters incremented. Default: Disabled
Rate limit CP untrusted ucast traffic (Mbps)	Specifies the untrusted unicast traffic rate limit. Range is 1-200 Mbps. Default: 10 Mbps
Rate limit CP untrusted mcast traffic (Mbps)	Specifies the untrusted multicast traffic rate limit. Range is 1-200 Mbps. Default: 2 Mbps
Rate limit CP trusted ucast traffic (Mbps)	Specifies the trusted unicast traffic rate limit. Range is 1-200 Mbps. Default: 80 Mbps
Rate limit CP trusted mcast traffic (Mbps)	Specifies the trusted multicast traffic rate limit. Range is 1-200 Mbps. Default: 2 Mbps
Rate limit CP route traffic (Mbps)	Specifies the traffic rate limit that needs ARP requests. Range is 1-200 Mbps. Default: 1 Mbps
Rate limit CP session mirror traffic (Mbps)	Specifies the session mirrored traffic forwarded to the controller. Range is 1-200 Mbps. Default: 1 Mbps
Rate limit CP auth process traffic (Mbps)	Specifies the traffic rate limit that is forwarded to the authentication process. Range is 1-200 Mbps. Default: 1 Mbps

Chapter 20

Virtual APs

APs advertise WLANs to wireless clients by sending out beacons and probe responses that contain the WLAN's SSID and supported authentication and data rates. When a wireless client associates to an AP, it sends traffic to the AP's Basic Service Set Identifier (BSSID) which is usually the AP's MAC address.

In the Dell network, an AP uses a unique BSSID for each WLAN. Thus a physical AP can support multiple WLANs. The WLAN configuration applied to a BSSID on an AP is called a *virtual AP*. You can configure and apply multiple virtual APs to an AP group or to an individual AP by defining one or more virtual AP profiles.

This chapter describes the following topics:

- "Configuring Virtual AP Profiles" on page 315
- "Configuring a Virtual AP " on page 316
- "Configuring a High-Throughput Virtual AP" on page 340

Configuring Virtual AP Profiles

You can configure virtual AP profiles to provide different network access or services to users on the same physical network. For example, you can configure a WLAN to provide access to guest users and another WLAN to provide access to employee users through the same APs. You can also configure a WLAN that offers open authentication and Captive Portal access with data rates of 1 and 2 Mbps and another WLAN that requires WPA authentication with data rates of up to 11 Mbps. You can apply both virtual AP configurations to the same AP or an AP group .

You can apply the same virtual AP profiles to one or more AP groups. For example, there are users in both Edmonton and Toronto that access the same "Corpnet" WLAN. Note that if your WLAN requires authentication to an external server, you may want to have users who associate with the APs in Toronto authenticate with their local servers. In this case, you can configure a slightly different AAA profiles; one that references authentication servers in the Edmonton and the other that references servers in Toronto (see to [Table 85](#)).

Table 85: Applying WLAN Profiles to AP Groups

WLAN Profiles	"default" AP Group	"Toronto" AP Group
Virtual AP	"Corpnet-E"	"Corpnet-T"
SSID	"Corpnet"	"Corpnet"
AAA	"E-Servers"	"T-Servers"

When you assign a profile to an individual AP, the values in the profile override the profile assigned to the AP group to which the AP belongs. The exception is the virtual AP profile. You can apply multiple virtual AP profiles to individual APs, as well as to AP groups.

You can exclude one or more virtual AP profiles from an individual AP. This prevents a virtual AP, defined at the AP group level, from being applied to a specific AP. For example, you can apply the virtual AP profile that corresponds

to the “Corpnet” SSID to the “default” AP group. If you do not want the “Corpnet” SSID to be advertised on the AP in the lobby, you can specify the virtual AP profile that contains the “Corpnet” SSID configuration be excluded from that AP.

Excluding a Virtual AP Profile From an AP in the WebUI

1. Navigate to the **Configuration > Wireless > AP Configuration > AP Specific** page.
2. Do one of the following:
 - If the AP you want to exclude is included in the list, click **Edit** for the AP.
 - If the AP does not appear in the list, click **New**. Either type in the name of the AP, or select the AP from the drop-down list. Then click **Add**.
3. Select **Wireless LAN** under the Profiles list, then select **Excluded Virtual AP**.
4. Select the name of the virtual AP profile you want to exclude from the drop down menu (under **ProfileDetails**) and click **Add**. The profile name appears in the **Excluded Virtual APs** list. You can add multiple profile names in the same way.
5. To remove a profile name from the Excluded Virtual APs list, select the profile name and click **Delete**.
6. Click **Apply**.

Excluding a Virtual AP Profile From an AP in the CLI

```
(host) (config) #ap-name <name>
    exclude-virtual-ap <profile>
```

Configuring a Virtual AP

This section includes examples of how to create virtual APs for a specific AP as well as for the “default” AP group, which includes all APs discovered by the controller. The configuration in this example contain the following WLANs:

- An 802.11a/b/g SSID called “Corpnet” that uses WPA2 and is available on all APs in the network
- An 802.11a/b/g SSID called “Guest” that uses open system and is only available on the AP “building3-lobby” (this AP will support both the “Corpnet” and “Guest” SSIDs)

Each WLAN requires a different SSID profile that maps into a separate virtual AP profile. For the SSID “Corpnet”, which will use WPA2, you need to configure an AAA profile that includes 802.1x authentication and an 802.1x authentication server group.

Because all APs discovered by the controller belong to the AP group called “default”, you assign the virtual AP profile that contains the SSID profile “Corpnet” to the “default” AP group. For the “Guest” SSID, you configure a new virtual AP profile that you assign to the AP named “building3-lobby”. [Table 86](#) lists the profiles that you need to modify or create for these examples.

Table 86: Profiles for Example Configuration

AP Group/Name	Virtual AP Profile	SSID Profile	AAA Profile
“default”	“corpnet” <ul style="list-style-type: none"> • VLAN: 1 • SSID profile: “corpnet” • AAA profile: “corpnet” 	“corpnet” <ul style="list-style-type: none"> • SSID: Corpnet • WPA2 	“corpnet” <ul style="list-style-type: none"> • 802.1x authentication default role: “employee” • 802.1x authentication server group: “corpnet” <ul style="list-style-type: none"> - Radius1 - Radius2

AP Group/Name	Virtual AP Profile	SSID Profile	AAA Profile
"building3-lobby"	"guest" <ul style="list-style-type: none"> • VLAN: 2 • Deny Time Range • SSID profile: "guest" • AAA profile: "default-open" 	"guest" <ul style="list-style-type: none"> • SSID: Guest • Open system 	"default-open" (This is a predefined, read-only AAA profile that specifies open system authentication)

Configuring the WLAN

In this example WLAN, users are validated against a corporate database on a RADIUS authentication server before they are allowed access to the network. Once validated, users are placed into a specified VLAN (VLAN 1 in this example) and assigned the user role "employee" that permits access to the corporate network.



NOTE: Dell recommends that you assign a unique name to each virtual AP, SSID, and AAA profile that you modify. In this example, you use the name "corpnet" to identify each of the profiles.

Follow the steps below to configure the Corpnet WLAN. Each of these steps are described in further detail later in this document.

1. Configure a policy for the user role **employee** and configure the user role **employee** with the specified policy.
2. Configure RADIUS authentication servers and assign them to the **corpnet** 802.1x authentication server group.
3. Configure authentication for the WLAN.
 - a. Create the **corpnet** 802.1x authentication profile.
 - b. Create the AAA profile **corpnet** and specify the previously-configured **employee** user role for the 802.1x authentication default role.
 - c. Specify the previously-configured **corpnet** 802.1x authentication server group.
4. For the AP group "default", create and configure the virtual AP **corpnet**.
 - a. Create a new virtual AP profile **corpnet**.
 - b. Select the previously-configured **corpnet** AAA profile for this virtual AP.
 - c. Create a new SSID profile **corpnet** to configure "Corpnet" for the SSID name and WPA2 for the authentication.

The following sections describe how to do this using the WebUI and the CLI.

Configuring the User Role

In this example, the **employee** user role allows unrestricted access to network resources and is granted only to users who have been successfully authenticated with an external RADIUS server. You can configure a more restrictive user role by specifying allowed or disallowed source and destination, protocol, and service for the traffic. For more information about configuring user roles, see ["Creating User Roles" on page 302](#).

In the WebUI

1. Navigate to the **Configuration > Security > Access Control > Policies** page.
2. Click **Add** to add a new policy. Enter the name of the policy.

Default settings for a policy rule permit all traffic from any source to any destination, but you can make a rule more restrictive. You can also configure multiple rules; the first rule in a policy that matches the traffic is applied.

Click **Add** to add a rule. When you are done adding rules, click **Apply**.

3. Click the **User Roles** tab. Click **Add** to add a new user role. Enter the name of the role. Under Firewall Policies, click **Add**. In the Choose from Configured Policies drop-down list, select the policy you previously created. Click **Done**.
4. Click **Apply**.

In the CLI

```
(host) (config) #ip access-list session <policy>
    <source> <dest> <service> <action>
(host) (config) #user-role employee
    access-list session <policy>
```

Configuring Authentication Servers

This example uses RADIUS servers for the client authentication. You need to specify the hostname and IP address for each RADIUS server and the shared secret used to authenticate communication between the server and the controller. After configuring authentication servers, assign them to the **corpnet** server group, an ordered list of the servers to be used for 802.1x authentication.

For more information about configuring authentication servers, see ["Configuring Servers" on page 169](#).

In the WebUI

1. Navigate to the **Configuration > Security > Authentication > Servers** page.
2. Select **Radius Server** to display the Radius Server List.
3. Enter the name of the server, and click **Add**. The server name appears in the list of servers.
4. Select the server name. Enter the IP address and shared secret for the server. Select the **Mode** checkbox to activate the authentication server.
5. Click **Apply** to apply the configuration.
6. Select **Server Group** on the Servers page.
7. Enter the name of the group, and click **Add**. The server group name appears in the list of server groups.
8. Select the server group name. Click **New** to add a server to the group. Under Server Name, select the server you just configured and click **Add**.
9. Click **Apply** to apply the configuration.

In the CLI

```
(host) (config) #aaa authentication-server radius Radius1
    host <ipaddr>
    key <key>
    enable
(host) (config) #aaa server-group corpnet
    auth-server Radius1
```

Configuring Authentication

In this example, you create the 802.1x authentication profile **corpnet**. The AAA profile configures the authentication for a WLAN. The AAA profile defines the type of authentication (802.1x in this example), the authentication server group, and the default user role for authenticated users.

In the WebUI

1. Navigate to the **Configuration > Security > Authentication > L2 Authentication** page. Select 802.1x Authentication Profile.

- a. In the 802.1x Authentication Profile list on the right window pane, enter **corpnet** in the entry blank at the bottom of the list, and click **Add**.
 - b. Select the corpnet 802.1x authentication profile you just created.
 - c. You can configure parameters in the **Basic** or **Advanced** tabs. These parameters are described in detail in [Table 29](#). For this example, you use the default values, so click **Apply**.
2. Select the **AAA Profiles** tab.
 - a. Scroll down to the bottom of the AAA Profiles Summary pane, then click **Add**. An entry blank appears.
 - b. Enter **corpnet**, then click **Add**.
 - c. Scroll back up the AAA Profiles Summary pane, and select the **corpnet** AAA profile you just created.
 - d. For this example, change the 802.1x Authentication Default Role, select the **employee** role you previously configured. You can also configure other the AAA profile parameters (see [Table 87](#)).
 - e. Click **Apply**.

Table 87: AAA Profile Parameters

Parameter	Description
Initial role	Click the Initial Role drop-down list and select a role for unauthenticated users. The default role for unauthenticated users is logon .
MAC Authentication Default Role	Click the MAC Authentication Default Role drop-down list and select the role assigned to the user when the device is MAC authenticated. The default role for MAC authentication is the guest user role. If derivation rules are present, the role assigned to the client through these rules take precedence over the default role. NOTE: This feature requires the PEFNG license.
802.1X Authentication Default Role	Click the 802.1X Authentication Default Role drop-down list and select the role assigned to the client after 802.1x authentication. The default role for 802.1x authentication is the guest user role. If derivation rules are present, the role assigned to the client through these rules take precedence over the default role. NOTE: This feature requires the PEFNG license.
RADIUS Interim Accounting	When this option is enabled, the RADIUS accounting feature allows the controller to send Interim-Update messages with current user statistics to the server at regular intervals. This option is disabled by default, allowing the controller to send only start and stop messages to the RADIUS accounting server.
User derivation rules	Click the User derivation rules drop-down list and specify a user attribute profile from which the user role or VLAN is derived.
Wired to Wireless Roaming	Enable this feature to keep users authenticated when they roam from the wired side of the network. This feature is enabled by default.
SIP authentication role	Click the SIP authentication role drop-down list and specify the role assigned to a session initiation protocol (SIP) client upon registration. NOTE: This feature requires the PEFNG license.
Device Type Classification	When you select this option, the controller will parse user-agent strings and attempt to identify the type of device connecting to the AP. When the device type classification is enabled, the Global client table shown in the Monitoring>Network>All WLAN Clients window shows each client's device type, if that client device can be identified.

Parameter	Description
Enforce DHCP	When you select this option, clients must obtain an IP using DHCP before they are allowed to associate to an AP. Enable this option when you create a user rule that assigns a specific role or VLAN based upon the client device's type. For details, see "Working with User-Derived VLANs" on page 306 . NOTE: If a client is removed from the user table by the "Logon user lifetime" AAA timer, then that client will not be able to send traffic until it renews its DHCP.

3. Select the 802.1x Authentication Profile under the corpnet AAA profile to reveal the 802.1X Authentication Profile pane.
 - a. Click the **802.1X Authentication Profile** drop-down list and select **corpnet**.
 - b. Click **Apply**.
4. Select the 802.1x Authentication Server Group under the corpnet AAA profile to reveal the 802.1X Authentication Server Group pane.
 - a. Click the **802.1X Authentication Server Group** drop-down list and select the **corpnet** server group you previously configured.
 - b. Click **Apply**.

In the CLI

```
(host)(config) #aaa authentication dot1x corpnet
(host)(config) #aaa profile corpnet
authentication-dot1x corpnet
d>ot1x-default-role employee
d>ot1x-server-group corpnet
radius-interim-accounting
```

Applying the Virtual AP

In this example, you apply the **corpnet** virtual AP to the "default" AP group which consists of all APs.

In the WebUI

1. Navigate to the **Configuration > Wireless > AP Configuration > AP Group** page.
2. Click **Edit** for the "default" AP group.
3. Select **Wireless LAN** (under **Profiles**), then select **Virtual AP**.
4. Select **New** from the **Add a profile** drop-down menu. Enter the name for the virtual AP profile (for example, **corpnet**), and click **Add**.



NOTE: Whenever you create a new virtual AP profile in the WebUI, the profile automatically contains the "default" SSID profile with the default "Dell-ap" ESSID. You must configure a new ESSID and SSID profile for the virtual AP profile before you apply the profile.

5. Click the new Virtual AP name in the Profiles list or the Profile Details to display the configuration parameters defined in [Table 88](#).
6. Verify that **Virtual AP enable** is selected; select 1 for the VLAN.
7. Click **Apply**.

The Virtual AP profile is divided into two tabs, **Basic** and **Advanced**. The **Basic** tab displays only those configuration settings that often need to be adjusted to suit a specific network. The **Advanced** tab shows all configuration settings, including settings that do not need frequent adjustment or should be kept at their default values. If you

change a setting on one tab then click and display the other tab without saving your configuration, that setting will revert to its previous value.

Table 88: Virtual AP Profile Parameters

Parameter	Description
Basic Configuration Settings	
Virtual AP enable	Select the Virtual AP enable checkbox to enable or disable the virtual AP.
VLAN	The VLAN(s) into which users are placed in order to obtain an IP address. Click the drop-down list to select a configured VLAN, then click the arrow button to associate that VLAN with the virtual AP profile.
Forward mode	<p>This parameter controls whether data is tunneled to the controller using generic routing encapsulation (GRE), bridged into the local Ethernet LAN (for remote APs), or a combination thereof depending on the destination (corporate traffic goes to the controller, and Internet access remains local). All forwarding modes support band steering, TSPEC/TCLAS enforcement, 802.11k and station blacklisting.</p> <p>Click the drop-down list to select one of the following forward modes:</p> <ul style="list-style-type: none"> ● Tunnel: The AP handles all 802.11 association requests and responses, but sends all 802.11 data packets, action frames and EAPOL frames over a GRE tunnel to the controller for processing. The controller removes or adds the GRE headers, decrypts or encrypts 802.11 frames and applies firewall rules to the user traffic as usual. Both remote and campus APs can be configured in tunnel mode. ● Bridge: 802.11 frames are bridged into the local Ethernet LAN. When a remote AP or campus AP is in bridge mode, the AP (and not the controller) handles all 802.11 association requests and responses, encryption/decryption processes, and firewall enforcement. The 802.11e and 802.11k action frames are also processed by the AP, which then sends out responses as needed. An AP in bridge mode does not support captive portal authentication. Both remote and campus APs can be configured in bridge mode. Note that you must enable the control plane security feature on the controller before you configure campus APs in bridge mode. ● Split-Tunnel: 802.11 frames are either tunneled or bridged, depending on the destination (corporate traffic goes to the controller, and Internet access remains local). A remote AP in split-tunnel forwarding mode handles all 802.11 association requests and responses, encryption/decryption, and firewall enforcement. The 802.11e and 802.11k action frames are also processed by the remote AP, which then sends out responses as needed. ● Decrypt-Tunnel: Both remote and campus APs can be configured in decrypt-tunnel mode. When an AP uses decrypt-tunnel forwarding mode, that AP decrypts and decapsulates all 802.11 frames from a client and sends the 802.3 frames through the GRE tunnel to the controller, which then applies firewall policies to the user traffic. When the controller sends traffic to a client, the controller sends 802.3 traffic through the GRE tunnel to the AP, which then converts it to encrypted 802.11 and forwards to the client. This forwarding mode allows a network to utilize the encryption/decryption capacity of the AP while reducing the demand for processing resources on the controller. APs in decrypt-tunnel forwarding mode also manage all 802.11 association requests and responses, and process all 802.11e and 802.11k action frames. APs using decrypt-tunnel mode do have some limitations that not present for APs in regular tunnel forwarding mode. You must enable the control plane security feature on the controller before you configure campus APs in decrypt-tunnel forward mode. <p>NOTE: Virtual APs in bridge or split-tunnel mode using static WEP should use key slots 2-4 on the controller. Key slot 1 should only be used with Virtual APs in tunnel mode.</p>
Allowed band	<p>The band(s) on which to use the virtual AP:</p> <ul style="list-style-type: none"> ● a—802.11a band only (5 GHz). ● g—802.11b/g band only (2.4 GHz). ● all—both 802.11a and 802.11b/g bands (5 GHz and 2.4 GHz). This is the default setting.

Parameter	Description
Band Steering	<p>ARM's band steering feature encourages dual-band capable clients to stay on the 5GHz band on dual-band APs. This frees up resources on the 2.4GHz band for single band clients like VoIP phones.</p> <p>Band steering reduces co-channel interference and increases available bandwidth for dual-band clients, because there are more channels on the 5GHz band than on the 2.4GHz band. Dual-band 802.11n-capable clients may see even greater bandwidth improvements, because the band steering feature will automatically select between 40MHz or 20MHz channels in 802.11n networks. This feature is disabled by default, and must be enabled in a Virtual AP profile.</p> <p>The band steering feature supports both campus APs and remote APs that have a virtual AP profile set to tunnel, split-tunnel or bridge forwarding mode. Note, however, that if a campus or remote APs has virtual AP profiles configured in bridge or split-tunnel forwarding mode but no virtual AP in tunnel mode, those APs will gather information about 5G-capable clients independently and will not exchange this information with other APs that also have bridge or split-tunnel virtual APs only.</p>
Steering Mode	<p>Band steering supports the following three different band steering modes.</p> <ul style="list-style-type: none"> ● Force-5GHz: When the AP is configured in force-5GHz band steering mode, the AP will try to force 5Ghz-capable APs to use that radio band. ● Prefer-5GHz (Default): If you configure the AP to use prefer-5GHz band steering mode, the AP will try to steer the client to 5G band (if the client is 5G capable) but will let the client connect on the 2.4G band if the client persists in 2.4G association attempts. ● Balance-bands: In this band steering mode, the AP tries to balance the clients across the two radios in order to best utilize the available 2.4G bandwidth. This feature takes into account the fact that the 5Ghz band has more channels than the 2.4 Ghz band, and that the 5Ghz channels operate in 40MHz while the 2.5Ghz band operates in 20MHz.
Dynamic Multicast Optimization (DMO)	<p>Enable/Disable dynamic multicast optimization. This parameter is disabled by default, and cannot be enabled without the PEFNG license.</p>
Drop Broadcast and Multicast	<p>Select the Drop Broadcast and Multicast checkbox to filter out broadcast and multicast traffic in the air.</p> <p>Do not enable this option for virtual APs configured in bridge forwarding mode. This configuration parameter is only intended for use for virtual APs in tunnel mode. In tunnel mode, all packets travel to the controller, so the controller is able to drop all broadcast traffic. When a virtual AP is configured to use bridge forwarding mode, most data traffic stays local to the AP, and the controller is not able to filter out that broadcast traffic.</p> <p>IMPORTANT: If you enable this option, you must also enable the Broadcast-Filter ARP parameter in the stateful firewall configuration to prevent ARP requests from being dropped. To enable this setting:</p> <ol style="list-style-type: none"> 1. Navigate to Configuration > Stateful Firewall. 2. Click the Global Setting tab. 3. Select the Broadcast-Filter ARP checkbox. 4. Click Apply to save your settings before you return to the Virtual AP Profile. <p>Note also that although a virtual AP profile can be replicated from a master controller to local Dell controllers, stateful firewall settings do not. If you select the Drop Broadcast and Multicast option for a Virtual AP Profile on a master controller, you must enable the Broadcast-Filter ARP setting on each individual local controller.</p>
Convert Broadcast ARP requests to unicast	<p>If enabled, all broadcast ARP requests are converted to unicast and sent directly to the client. You can check the status of this option using the show ap active and the show datapath tunnel command. If enabled, the output will display the letter a in the flags column.</p> <p>This configuration parameter is only intended for use for virtual APs in tunnel mode. In tunnel mode, all packets travel to the controller, so the controller is able to convert ARP requests directed to the broadcast address into unicast.</p> <p>When a virtual AP is configured to use bridge forwarding mode, most data traffic stays local to</p>

Parameter	Description
	<p>the AP, and the controller is not able to convert that broadcast traffic.</p> <p>Beginning with ArubaOS 6.1.3.2, this parameter is enabled by default. Behaviors associated with these settings are enabled upon upgrade to ArubaOS 6.1.3.2. If your controller supports clients behind a wireless bridge or virtual clients on VMware devices, you must disable this setting to allow those clients to obtain an IP address. In previous releases of ArubaOS, the virtual AP profile included two unique broadcast filter parameters; the drop broadcast and multicast parameter, which filtered out all broadcast and multicast traffic in the air except DHCP response frames (these were converted to unicast frames and sent to the corresponding client) and the convert ARP requests to unicast parameter, which converted broadcast ARP requests to unicast messages sent directly to the client.</p> <p>Starting with ArubaOS 6.1.3.2, the Convert Broadcast ARP requests to unicast setting includes the additional functionality of broadcast-filter all parameter, where DHCP response frames are sent as unicast to the corresponding client. This can impact DHCP discover/requested packets for clients behind a wireless bridge and virtual clients on VMware devices. Disable this option to resolve this issue and allow clients behind a wireless bridge or VMware devices to receive an IP address.</p> <p>Default: Enabled</p>
Advanced Configuration Settings	
Dynamic Multicast Optimization (DMO) Threshold	<p>Maximum number of high-throughput stations in a multicast group beyond which dynamic multicast optimization stops.</p> <p>Range: 2-255 stations</p> <p>Default: 6 stations.</p>
Blacklist Time	<p>Number of seconds that a client is quarantined from the network after being blacklisted.</p> <p>Default: 3600 seconds (1 hour)</p>
Authentication Failure Blacklist Time	<p>Time, in seconds, a client is blocked if it fails repeated authentication. The default setting is 3600 seconds (1 hour). A value of 0 blocks the client indefinitely.</p>
Deny inter user traffic	<p>Select this checkbox to deny traffic between the clients using this virtual AP profile.</p> <p>The global firewall shown the Configuration>Advanced Services > Stateful Firewall > Global window also includes an option to deny all inter-user traffic, regardless of the Virtual AP profile used by those clients.</p> <p>If the global setting to deny inter-user traffic is enabled, all inter-user traffic between clients will be denied, regardless of the settings configured in the virtual AP profiles. If the setting to deny inter-user traffic is disabled globally but enabled on an individual virtual ap, only the traffic between un-trusted users and the clients on that particular virtual AP will be blocked.</p>
Deny time range	<p>Click the drop-down list and select a configured time range for which the AP will deny access. If you have not yet configured a time range, navigate to Configuration > Security > Access Control > Time Ranges to define a time range before configuring this setting in the virtual AP profile.</p>
DoS Prevention	<p>If enabled, APs ignore deauthentication frames from clients. This prevents a successful deauthorization attack from being carried out against the AP. This does not affect third-party APs. Default: Disabled</p>
HA Discovery on-association	<p>If enabled, home agent discovery is triggered on client association instead of home agent discovery based on traffic from client. Mobility on association can speed up roaming and improve connectivity for clients that do not send many uplink packets to trigger mobility (VoIP clients). Best practices is to disable this parameter as it increases IP mobility control traffic between Dell controllers in the same mobility domain. Enable this parameter only when voice issues are observed in VoIP clients.</p> <p>Default: Disabled</p> <p>NOTE: <code>ha-disc-onassoc</code> parameter works only when IP mobility is enabled and configured</p>

Parameter	Description
	on the controller. For more information about this parameter, see "HA Discovery on Association" on page 499
Mobile IP	Enables or disables IP mobility for this virtual AP. Default: Enabled
Preserve Client VLAN	If you select this checkbox, clients retain their previous VLAN assignment if the client dis-associates from an AP and then immediately re-outassociates either with same AP or another AP on the same controller.
Q-in-Q Outer VLAN	
Remote-AP Operation	Configures when the virtual AP operates on a remote AP: <ul style="list-style-type: none"> ● always—Permanently enables the virtual AP (Bridge Mode only). No authentication supported. ● backup—Enables the virtual AP if the remote AP cannot connect to the controller (Bridge Mode only). No authentication supported. ● persistent—Permanently enables the virtual AP after the remote AP initially connects to the controller (Bridge Mode only). ● standard—Enables the virtual AP when the remote AP connects to the controller. Use standard option for tunneled, split-tunneled, and Bridge SSIDs. NOTE: Only open/PSK security mode is allowed for always/backup RAP operation. No authentication is supported for always/backup.
Station Blacklisting	Select the Station Blacklisting checkbox to enable detection of denial of service (DoS) attacks, such as ping or SYN floods, that are not spoofed deauthorization attacks. Default: Enabled
Strict Compliance	If enabled, the AP denies client association requests if the AP and client station have no common rates defined. Some legacy client stations which are not fully 802.11-compliant may not include their configured rates in their association requests. Such non-compliant stations may have difficulty associating with APs unless strict compliance is disabled. This parameter is disabled by default.
VLAN Mobility	Enable or disable VLAN (Layer-2) mobility. Default: Disabled
FDB Update on Assoc	This parameter enables seamless failover for silent clients, allowing them to re-associate. If you select this option, the controller will generate a Layer 2 update on behalf of client to update forwarding tables in bridge devices. Default: Disabled

In the Profile Details entry for the new virtual AP profile, navigate to the **AAA Profile** drop-down list and select the AAA profile you previously configured to reveal the AAA Profile pop-up window. Click **Apply** to set the AAA profile and close the pop-up window.

In the CLI

```
(host) (config) #wlan virtual-ap corpnet
    vlan 1
    aaa-profile corpnet
    ap-group default
    virtual-ap corpnet
```

Creating a new SSID Profile

Follow the procedures below to create a new SSID profile and associate that profile to your Virtual AP.

In the WebUI

1. Navigate to the **Configuration > Wireless > AP Configuration > AP Group** page.
2. Click **Edit** for the “default” AP group.
3. Select **Wireless LAN** (under **Profiles**), then select **Virtual AP**.
4. Click the new Virtual AP name in the Profiles list.
5. Select **New** from the **SSID Profile** drop-down menu in the Profile Details entry for the new virtual AP profile. This launches an SSID profile pop-up window.

The SSID profile configuration settings are divided into two tabs, **Basic** and **Advanced**. The **Basic** tab displays only those configuration settings that often need to be adjusted to suit a specific network. The **Advanced** tab shows all configuration settings, including settings that do not need frequent adjustment or should be kept at their default values. If you change a setting on one tab then click and display the other tab without saving your configuration, that setting will revert to its previous value. Both basic and advanced settings are described in [Table 51](#).

6. Click the **Basic** tab.
7. Enter the name for the SSID profile (for example, **SSIDprofile**).
8. Enter a name in the Network Name (SSID) field (for example, **Corpnet**).
9. Select **WPA2** for Network Authentication.
10. (Optional) Configure other basic SSID profile settings as desired.
11. Click the **Advanced** tab.
12. Click **SSID Enable** to enable the SSID.
13. (Optional) Configure advanced SSID profile settings.
14. Click **Apply** to set the SSID profile and close the pop-up window.
15. Click **Apply** again at the bottom of the Profile Details window.

Table 89: SSID Profile Parameters

Parameter	Description
Basic SSID Profile Settings	
Network Name	Name that uniquely identifies a wireless network. The network name, or <i>ESSID</i> can be up to 31 characters. If the <i>ESSID</i> includes spaces, you must enclose it in quotation marks.
Network Authentication	The layer-2 authentication to be used on this <i>ESSID</i> to protect access and ensure the privacy of the data transmitted to and from the network. <ul style="list-style-type: none">• None• 802.1x/WEP• WPA• WPA-PSK• WPA2• WPA2-PSK• xSec• Mixed If you select the Mixed authentication option, a drop-down list will appear in the Network Authentication section. Click this drop-down list and select the combination of authentication types supported by APs using this SSID profile.
Encryption	This field shows the default encryption type used on this <i>ESSID</i> . Unselect the default encryption type if you do not want encryption, or click the Advanced tab to define a new encryption type.

Parameter	Description
Keys	<p>If you selected WPA-PSK or WPA2-PSK authentication or a mixed authentication type that supports pre-shared keys, enter and confirm the Hex Key or PSK passphrase in the PSK Key/Passphrase and Confirm PSK Key/Passphrase fields.</p> <ul style="list-style-type: none"> To define a hex key, enter a 64-character hexadecimal string. To define a PSK passphrase, enter an ASCII string 8-63 characters in length. <p>Next click the Format drop-down list and select Hex or PSK Passphrase to select the format for the key or passphrase.</p>
Advanced SSID Profile Settings	
SSID Enable	Click this checkbox to enable or disable the SSID. The SSID is enabled by default.
Encryption	Select one of the following encryption types
xSec	Encryption and tunneling of Layer-2 traffic between the controller and wired or wireless clients, or between Dell controllers. To use xSec encryption, you must use a RADIUS authentication server. For clients, you must install the Funk Odyssey client software. Requires installation of the xSec license. For xSec between Dell controllers, you must install an xSec license in each controller.
opensystem	No authentication and encryption.
static-wep	WEP with static keys.
dynamic-wep	WEP with dynamic keys.
wpa-tkip	WPA with TKIP encryption and dynamic keys using 802.1x.
wpa-aes	WPA with AES encryption and dynamic keys using 802.1x.
wpa-psk-tkip	WPA with TKIP encryption using a preshared key.
wpa-psk-aes	WPA with AES encryption using a preshared key.
wpa2-aes	WPA2 with AES encryption and dynamic keys using 802.1x.
wpa2-psk-aes	WPA2 with AES encryption using a preshared key.
wpa2-psk-tkip	WPA2 with TKIP encryption using a preshared key.
wpa2-tkip	WPA2 with TKIP encryption and dynamic keys using 802.1x.
wpa2-aes-gcm-128	WPA2 with AES GCM-128 (Suite-b) encryption and dynamic keys using 802.1X. NOTE: This parameter requires the ACR license. For further information on Suite-B encryption, see "Configuring an SSID for Suite-B Cryptography" on page 329.
wpa2-aes-gcm-256	WPA2 with AES GCM-256 (Suite-b) encryption and dynamic keys using 802.1X. NOTE: This parameter requires the ACR license. For further information on Suite-B encryption, see "Configuring an SSID for Suite-B Cryptography" on page 329.
DTIM Interval	Specifies the interval, in milliseconds, between the sending of Delivery Traffic Indication Messages (DTIMs) in the beacon. This is the maximum number of beacon cycles before unacknowledged network broadcasts are flushed. When using wireless clients that employ

Parameter	Description
	power management features to sleep, the client must revive at least once during the DTIM period to receive broadcasts
802.11g Transmit Rates	Select the set of 802.11b/g rates at which the AP is allowed to send data. The actual transmit rate depends on what the client is able to handle, based on information sent at the time of association and on the current error/loss rate of the client.
802.11g Basic Rates	Select the set of supported 802.11b/g rates that are advertised in beacon frames and probe responses.
802.11a Transmit Rates	Select the set of 802.11a rates at which the AP is allowed to send data. The actual transmit rate depends on what the client is able to handle, based on information sent at the time of association and on the current error/loss rate of the client.
802.11a Basic Rates	Select the set of supported 802.11a rates, in Mbps, that are advertised in beacon frames and probe responses.
Station Ageout Time	Time, in seconds, that a client is allowed to remain idle before being aged out.
Max Transmit Attempts	Maximum number of retries allowed for the AP to send a frame.
RTS Threshold	Wireless clients transmitting frames larger than this threshold must issue Request to Send (RTS) and wait for the AP to respond with Clear to Send (CTS). This helps prevent mid-air collisions for wireless clients that are not within wireless peer range and cannot detect when other wireless clients are transmitting. The default value is 2333 bytes.
Short Preamble	Click this checkbox to enable or disable a short preamble for 802.11b/g radios. Network performance may be higher when short preamble is enabled. In mixed radio environments, some 802.11b wireless client stations may experience difficulty associating with the AP using short preamble. To use only long preamble, disable short preamble. Legacy client devices that use only long preamble generally can be updated to support short preamble.
Max Associations	Maximum number of wireless clients for the AP. The supported range is 0-256 clients.
Wireless Multimedia (WMM)	Enables or disables WMM, also known as IEEE 802.11e Enhanced Distribution Coordination Function (EDCF). WMM provides prioritization of specific traffic relative to other traffic in the network.
Wireless Multimedia U-APSD (WMM-UAPSD) Powersave	Enable Wireless Multimedia (WMM) UAPSD powersave.
WMM TSPEC Min Inactivity Interval	Specify the minimum inactivity time-out threshold of WMM traffic. This setting is useful in environments where low inactivity interval time-outs are advertised, which may cause unwanted timeouts. The supported range is 0-3,600,000 milliseconds, and the default value is 0 milliseconds.
Override DSCP mappings for WMM clients	Override the default DSCP mappings in the SSID profile with the ToS value. This setting is useful when you want to set a non-default ToS value for a specific traffic.
DSCP mapping for WMM voice AC	DSCP used to map WMM voice traffic. The supported range is 0-63.
DSCP mapping for WMM video AC	Select the DSCP used to map WMM video traffic.

Parameter	Description
	The supported range is 0-63.
DSCP mapping for WMM best-effort AC	Select the DSCP value used to map WMM best-effort traffic. The supported range is 0-63.
DSCP mapping for WMM background AC	Select the DSCP used to map WMM background traffic. The supported range is 0-63.
Hide SSID	Select this checkbox to enable or disable the hiding of the SSID name in beacon frames. Note that hiding the SSID does very little to increase security.
Deny_Broadcast Probes	When a client sends a broadcast probe request frame to search for all available SSIDs, this option controls whether or not the system responds for this SSID. When enabled, no response is sent and clients have to know the SSID in order to associate to the SSID. When disabled, a probe response frame is sent for this SSID.
Local Probe Request Threshold (dB)	Enter the SNR threshold below which incoming probe requests will get ignored. The supported range of values is 0-100 dB. A value of 0 disables this feature.
Disable Probe Retry	Click this checkbox to enable or disable battery MAC level retries for probe response frames. By default this parameter is enabled, which mean that MAC level retries for probe response frames is disabled.
Battery Boost	Converts multicast traffic to unicast before delivery to the client, thus allowing you to set a longer DTIM interval. The longer interval keeps associated wireless clients from activating their radios for multicast indication and delivery, leaving them in power-save mode longer and thus lengthening battery life. This parameter requires the PEFNG license.
WEP Key 1	First static WEP key associated with the key index. Can be 10 or 26 hex characters in length.
WEP Key 2	Second static WEP key associated with the key index. Can be 10 or 26 hex characters in length.
WEP Key 3	Third Static WEP key associated with the key index. Can be 10 or 26 hex characters in length.
WEP Key 4	Fourth Static WEP key associated with the key index. Can be 10 or 26 hex characters in length.
WEP Transmit Key Index	Key index that specifies which static WEP key is to be used. Can be 1, 2, 3, or 4.
WPA Hexkey	WPA pre-shared key (PSK).
WPA Passphrase	WPA passphrase with which to generate a pre-shared key (PSK).
Maximum Transmit Failures	The AP assumes the client has left and should be deauthorized when the AP detects this number of consecutive frames were not delivered because the maximum retry threshold as been exceeded.
BC/MC Rate Optimization	Click this checkbox to enable or disable scanning of all active stations currently associated to an AP to select the lowest transmission rate for broadcast and multicast frames. This option only applies to broadcast and multicast data frames; 802.11 management frames are transmitted at the lowest configured rate. NOTE: Do not enable this parameter unless instructed to do so by your Dell technical support representative.
Strict Spectralink Voice Protocol (SVP)	Click this checkbox to enable Strict Spectralink Voice Protocol (SVP)

Parameter	Description
802.11g Beacon Rate	Click this drop-down list to select the beacon rate for 802.11g (use for Distributed Antenna System (DAS) only). Using this parameter in normal operation may cause connectivity problems.
802.11a Beacon Rate	Click this drop-down list to select the beacon rate for 802.11a (use for Distributed Antenna System (DAS) only). Using this parameter in normal operation may cause connectivity problems.
Advertise QBSS Load IE	Click this checkbox to enable the AP to advertise the QBSS load element. The element includes the following parameters that provide information on the traffic situation: <ul style="list-style-type: none"> ● Station count: The total number of stations associated to the QBSS. ● Channel utilization: The percentage of time (normalized to 255) the channel is sensed to be busy. The access point uses either the physical or the virtual carrier sense mechanism to sense a busy channel. ● Available admission capacity: The remaining amount of medium time (measured as number of 32us/s) available for a station via explicit admission control. The QAP uses these parameters to decide whether to accept an admission control request. A wireless station uses these parameters to choose the appropriate access points. NOTE: Ensure that WMM is enabled for legacy APs to advertise the QBSS load element. For 802.11n APs, ensure that either wmm or high throughput is enabled.
Advertise Location Information	When this option is enabled, APs broadcast their location within a IE carried in Beacon frames and Probe Response frames. The AP's latitude, longitude and altitude can be configured on the Configuration > Wireless > AP Installation page of the controller WebUI, or using the provision-ap command in the controller command-line interface.
Advertise AP Name	If this parameter enabled, APs will broadcast the AP name configured by the <code>ap-name</code> command. This option is disabled by default.
Enforce User VLAN for Open Stations	Select this option to restrict data traffic from open stations to the user's assigned VLAN. This option is disabled by default.

In the CLI

```
(host) (config) #wlan ssid-profile SSIDprofile
    essid Corpnet
    opmode wpa2-aes
(host) (config) #wlan virtual-ap corpnet
    ssid-profile SSIDprofile
(host) (config) #ap-group default
    virtual-ap corpnet
```

Configuring an SSID for Suite-B Cryptography

Suite-B AES-128-GCM and AES-256-GCM encryption is supported by the ArubaOS hardware, and requires the ACR license. Note, however, that not all Dell controllers support Suite-B encryption. The table below describes the controller support for Suite-B encryption in ArubaOS.

W-600 Series	All serial numbers supported	Yes
W-3000 Series	AK	Yes
W-3000 Series	A	No

To determine the serial number prefix for your controller, issue the CLI command `show inventory` and note the prefix before the system serial number. The serial number prefix in the example below appears in **bold**.

```
(host) #show inventory
Supervisor Card slot      : 0
System Serial#           : AK0093676
```

SC Assembly# : 2010052B (Rev:02.01)
SC Serial# : F01629529 (Date:03/29/10)
SC Model# : W-3600-US

Configuring a Guest WLAN

To configure a Guest WLAN, the following basic steps are required.

- Configure the VLAN for guest users.
- Configure the guest role which only allows HTTP and HTTPS traffic from 9:00 a.m. to 5 p.m. on weekdays.
- Create and configure the virtual AP profile **guest** for the AP named “building3-lobby”:
 - Create a new virtual AP profile **guest**.
 - Select the predefined AAA profile **default-open**.
 - Create a new SSID profile **guest** to configure “Guest” for the SSID name and open system for the authentication.

The following sections describe how to do this using the WebUI and the CLI.

Configuring a VLAN

In this example, users on the “Corpnet” WLAN are placed into VLAN 1, which is the default VLAN configured on the controller. For guest users, you need to create another VLAN and assign the VLAN interface an IP address.

In the WebUI

1. Navigate to the **Configuration > Network > VLANs** page.
2. Click **Add** to add a VLAN. Enter 2 in the VLAN ID, and click **Apply**.
3. To assign an IP address and netmask to the VLAN you just created, navigate to the **Configuration > Network > IP > IP Interfaces** page. Click **Edit** for VLAN 2. Enter an IP address and netmask for the VLAN interface, and then click **Apply**.

In the CLI

```
(host) (config) #vlan 2
interface vlan 2
ip address <address> <netmask>
```

Configuring a Guest Role

The guest role allows web (HTTP and HTTPS) access only during normal business hours (9:00 a.m. to 5:00 p.m. Monday through Friday).

In the WebUI

1. Navigate to the **Configuration > Security > Access Control > Time Ranges** page.
2. Click **Add**. Enter a name, such as “workhours”. Select Periodic. Click **Add**. Under Add Periodic Rule, select Weekday. For Start Time, enter 9:00. For End Time, enter 17:00. Click **Done**. Click **Apply**.
3. Select the **Policies** tab. Click **Add**. Enter a policy name, such as “restricted”. From the **Policy Type** drop-down list, select **Session**.
4. Click **Add**.
5. *(Optional)* By default, firewall policies apply to IPv4 clients only. To configure a firewall policy for IPv6 clients, click the **IP Version** drop-down list and select **IPv6**.
6. Click the **Service** drop-down list, select **service**, then select **svc-http**.
7. Click the **Time Range** drop-down list and select the time range you previously configured.

8. Click **Add**.
9. Repeat steps 4-8 to add another rule for the *svc-https* service. Click **Apply**.
10. Select the **User Roles** tab. Click **Add**. Enter *guest* for Role Name. Under Firewall Policies, click **Add**. Select Choose from Configured Policies and select the policy you previously configured. Click **Done**.
11. Click **Apply**.

In the CLI

```
(host)(config) #time-range workhours periodic
    weekday 09:00 to 17:00
(host)(config) #ip access-list session restricted
    any any svc-http permit time-range workhours
    any any svc-https permit time-range workhours
(host)(config) #user-role guest
    session-acl restricted
```

Configuring a Guest Virtual AP

In this example, you apply the *guest* virtual AP profile to a specific AP.



NOTE: Best practices are to assign a unique name to each virtual AP, SSID, and AAA profile that you modify. In this example, you use the name *guest* to identify the virtual AP and SSID profiles.

In the WebUI

1. Navigate to **Configuration > Wireless > AP Configuration > AP Specific** page.
2. Click **New**. Either enter the AP name or select an AP from the list of discovered APs. Click **Add**. The AP name appears in the list.
3. Click **Edit** by the AP name to display the profiles that you can configure for the AP.
4. Expand the **Wireless LAN** profile menu.
5. Select **Virtual AP**.
 - a. Click the **Add a profile** drop down list in the **Profile Details** window and select **NEW**.
 - b. Enter *guest*, and click **Add**.
 - c. Click **Apply**.
6. Click the *guest* virtual AP to display profile details.
 - a. Make sure **Virtual AP Enable** is selected.
 - b. Select **2** for the **VLAN**.
 - c. Click **Apply**.
7. Under **Profiles**, select the AAA profile under the *guest* virtual AP profile.
 - a. In the **Profile Details**, select **default-open** from the **AAA Profile** drop-down list.
 - b. Click **Apply**.
8. Under **Profiles**, select the SSID profile under the *guest* virtual AP profile.
 - a. Select **NEW** from the **SSID Profile** drop-down menu.
 - b. Enter *guest*.
 - c. In the **Profile Details**, enter **Guest** for the **Network Name**.
 - d. Select **None** for **Network Authentication** and **Open** for **Encryption**.
 - e. Click **Apply**.

In the CLI

```
(host) (config) #wlan ssid-profile guest
    opmode opensystem
(host) (config) #wlan virtual-ap guest
    vap-enable
    vlan 2
    d>eny-time-range workhours
    ssid-profile guest
    aaa-profile default-open
(host) (config) #ap-name building3-lobby
    virtual-ap guest
```

Enabling bSec SSID Support

The bSec protocol is a pre-standard protocol that has been proposed to the IEEE 802.11 committee as an alternative to 802.11i. The main difference between bSec and standard 802.11i is that bSec implements Suite B algorithms wherever possible. Notably, AES-CCM is replaced by AES-GCM, and the Key Derivation Function (KDF) of 802.11i is upgraded to support SHA-256 and SHA-384. In order to provide interoperability with standard Wi-Fi software drivers, bSec is implemented as a shim layer between standard 802.11 Wi-Fi and a Layer 3 protocol such as IP. A controller configured to advertise a bSec SSID will advertise an open network, however only bSec frames will be permitted on the network.

The bSec protocol requires that you use VIA 2.1.1 or greater on the client device. Consult VIA documentation for more information on configuring and installing VIA.

The bSec protocol is available in 128-bit mode and 256-bit mode. The number of bits specifies the length of the AES-GCM encryption key. Using United States Department of Defense classification terminology,

bSec-128 is suitable for protection of information up to the SECRET level, while bSec-256 is suitable for protection of information up to the TOP SECRET level.

In the CLI

To enable a bSec SSID using bSec-128, configure the opmode parameter in the SSID profile:

```
(host) (config) #wlan ssid-profile <profilename>
(host) (SSID Profile "<profilename>") #opmode bSec-128
```

To enable a bSec SSID using bSec-256, configure the opmode parameter in the SSID profile:

```
(host) (config) #wlan ssid-profile <profilename>
(host) (SSID Profile "<profilename>") #opmode bSec-256
```

In the WebUI

To enable bSec SSID using bSec-128 or bSec-256:

1. Navigate to **Configuration > AP Group > Wireless LAN > Virtual AP > SSID Profile**.
2. Select the **Advanced** Tab.
3. Next to Encryption, select **bSec-128** and/or **bSec-256**.
4. Click **Apply**.

Sample Configuration

The example below follows the suggested order of steps to configure a virtual AP using the command-line interface.

```
(host) (config) #vlan 60
!
(host) (config) #ip access-list session THR-POLICY-NAME-WPA2
    user any any permit
!
```

```

(host) (config) #user-role THR-ROLE-NAME-WPA2
    session-acl THR-POLICY-NAME-WPA2
!
(host) (config) #aaa authentication dot1x "THR-DOT1X-AUTH-PROFILE-WPA2"
    termination enable
!
(host) (config) #aaa server-group "THR-DOT1X-SERVER-GROUP-WPA2"
    auth-server Internal
!
(host) (config) #aaa profile "THR-AAA-PROFILE-WPA2"
    authentication-dot1x "THR-DOT1X-AUTH-PROFILE-WPA2"
    dot1x-default-role "THR-ROLE-NAME-WPA2"
    dot1x-server-group "THR-DOT1X-SERVER-GROUP-WPA2"
!
(host) (config) #wlan ssid-profile "THR-SSID-PROFILE-WPA2"
    ssid "THR-WPA2"
    opmode wpa2-aes
!
(host) (config) #wlan virtual-ap "THR-VIRTUAL-AP-PROFILE-WPA2"
    ssid-profile "THR-SSID-PROFILE-WPA2"
    aaa-profile "THR-AAA-PROFILE-WPA2"
    vlan 60
!
(host) (config) #ap system-profile "THR-AP-SYSTEM-PROFILE"
    lms-ip 1.1.1.1
    bkup-lms-ip 2.2.2.2
!
(host) (config) #ap-group "THRQ1-STANDARD"
    virtual-ap "THR-VIRTUAL-AP-PROFILE-WPA2"
(host) (config) #ap-system-profile "THR-AP-SYSTEM-PROFILE"

```

Enabling 802.11k Support

The 802.11k protocol provides mechanisms for APs and clients to dynamically measure the available radio resources. In an 802.11k enabled network, APs and clients can send neighbor reports, beacon reports, and link measurement reports to each other. This allows the APs and clients to take appropriate connection actions. The following procedure outlines the steps to configure 802.11k parameters.

 NOTE: The handover process is available for voice clients that support the 802.11k standard and have the ability to transmit and receive beacon reports. For information on configuring the handoff trigger feature, see ["Enabling Wi-Fi Edge Detection and Handover for Voice Clients" on page 709](#)

In the WebUI

1. Navigate to the **Configuration > Wireless > AP Configuration** window. Select either the **AP Group** or **AP Specific** tab.
 - If you selected the **AP Group** tab, click the **Edit** button by the AP group name for which you want to configure the new 802.11K profile.
 - If you selected the **AP Specific** tab, click the **Edit** button by the AP for which you want to create the 802.11K profile.
2. In the Profiles list, expand the **Wireless LAN** menu, then expand the **Virtual AP** menu.
3. Select the Virtual AP profile for which you want to configure 802.11k settings.

To edit an existing 802.11k profile, click the **802.11K Profile** drop-down list In the **Profile Details** window pane and select the 802.1x profile you want to edit.

or

To create a new 802.11k Profile, click the **802.11K Profile** drop-down list and select **New**. Enter a new 802.11k profile name in the field to the right of the drop-down list.

- Configure your 802.11k radio settings. [Table 90](#) outlines the parameters you can configure in the 802.11k profile. Click **Apply** to save your settings.

Table 90: 802.11k Profile Parameters

Parameter	Description
Advertise 802.11K Capability	Select this option to allow Virtual APs using this profile to advertise 802.11K capability. Default: Disabled
Forcefully disassociate on-hook voice clients	Select this option to allow the AP to forcefully disassociate <i>on-hook</i> voice clients (clients that are not on a call) after period of inactivity. Without the forced disassociation feature, if an AP has reached its call admission control limits and an on-hook voice client wants to start a new call, that client may be denied. If forced disassociation is enabled, those clients can associate to a neighboring AP that can fulfill their QoS requirements. Default: Disabled
Measurement Mode for Beacon Reports	Click the Measurement Mode for Beacon Reports drop-down list and specify one of the following measurement modes: <ul style="list-style-type: none"> active—Enables active beacon measurement mode. In this mode, the client sends a probe request to the broadcast destination address on all supported channels, sets a measurement duration timer, and, at the end of the measurement duration, compiles all received beacons or probe response with the requested SSID and BSSID into a measurement report. beacon-table—Enables beacon-table beacon measurement mode. In this mode, the client measures beacons and returns a report with stored beacon information for any supported channel with the requested SSID and BSSID. The client does not perform any additional measurements. passive—Enables passive beacon measurement mode. In this mode, the client sets a measurement duration timer, and, at the end of the measurement duration, compiles all received beacons or probe response with the requested SSID and BSSID into a measurement report. <p>NOTE: If a station doesn't support the selected measurement mode, it returns a Beacon Measurement Report with the Incapable bit set in the Measurement Report Mode field. Default Mode: beacon-table</p>
Channel for Beacon Requests in 'A' band	This value is sent in the 'Channel' field of the beacon requests on the 'A' radio. You can specify values in the range 34 to 165. The default value is 36.
Channel for Beacon Requests in 'BG' band	This value is sent in the 'Channel' field of the Beacon Requests on the 'BG' radio. You can specify values in the range 1 to 14. The default value is 1.
Channel for AP Channel Reports in 'A' band	This value is sent in the 'Channel' field of the AP channel reports on the 'A' radio. You can specify values in the range 34 to 165. The default value is 36.
Channel for AP Channel Reports in 'BG' band	This value is sent in the 'Channel' field of the AP channel reports on the 'BG' radio. You can specify values in the range 1 to 14. The default

Parameter	Description
	value is 1.
Time duration between consecutive Beacon Requests	This option configures the time duration between two consecutive beacon requests sent to a dot11K client. By default, the beacon requests are sent to a dot11K client every 60 seconds. However, if a different value is required, the <code>bcn-req-time</code> option can be used. This permits values in the range from 10 seconds to 200 seconds. A value of 0 is used to indicate that the generation of Beacon Request frames is turned off.
Time duration between consecutive Link Measurement Requests	This option configures the time duration between two consecutive link measurement requests sent to an dot11K client. By default, link measurement requests are sent to a dot11K client every 61 seconds. However, you can use the <code>lm-req-time</code> option to specify different time interval. This permits values in the range from 10 seconds to 200 seconds. A value of 0 is used to indicate that the generation of Link Measurement Request frames is turned off.
Time duration between consecutive Transmit Stream Measurement Request	This option configures the time duration between two consecutive transmit stream measurement requests sent to a dot11K client. By default, the transmit stream measurement requests are sent to a dot11K client every 90 seconds. However, you can use the <code>tsm-req time</code> option to specify a different time interval. This permits values in the range from 10 seconds to 200 seconds. A value of 0 is used to indicate that the generation of Transmit Stream Measurement Request frames is turned off.
Handover Trigger Feature Settings Profile	This command configures a Handover Trigger Profile. This profile consists of the configurable parameters for the 'Wi-Fi Edge Detection and Handover of Voice Clients' feature.
Beacon Report Request Settings Profile	Configure a Beacon Report Request Profile to provide the parameters for the Beacon Report Request frames.
TSM Report Request Settings Profile	This command configures a TSM Report Request Profile which is used to provide values to the Transmit Stream/Category Measurement Request frame.

In the CLI

Use the following command to configure 802.11k profiles. The available parameters for this profile are described in [Table 90](#).

```
(host) (config) #wlan dot11k-profile default ?
<cr>
(host) (config) #wlan dot11k-profile default
(host) (802.11K Profile "default") #?
ap-chan-rpt-11a          Set channel for AP Channel Reports in 'A' band. Range: [34-165],
Default: 36
ap-chan-rpt-11bg        Set channel for AP Channel Reports in 'BG' band. Range: [1-14],
Default: 1
bcn-measurement-mode     Set Measurement Mode for Beacon Reports
bcn-req-chan-11a         Set channel value for Beacon Requests in 'A' band;The value must be
in the range [34-165] or 0 or 255, Default: 36
bcn-req-chan-11bg        Set channel value for Beacon Requests in 'BG' band;The value must be
in the range [1-14] or 0 or 255, Default: 1
bcn-req-time             Set time duration between consecutive Beacon Requests. Range: 10-200
sec, Default: 60 sec,Turn-Off: 0
```

```

bcn-rpt-req-profile      Beacon Report Request Settings
clone                   Copy data from another 802.11K Profile
dot11k-enable           Enable 802.11K Capability
force-disassoc          Force disassociation of on-hook voice clients when either PCT limit
                        or CHR limit is reached.
handover-trigger-prof.. Handover Trigger Feature Settings
lm-req-time             Set time duration between consecutive Link Measurement Requests.
Range: 10-200 sec, Default: 60sec, Turn-Off: 0
no                      Delete Command
rrm-ie-profile          RRM IE Settings Profile
tsm-req-profile         TSM Report Request Settings
tsm-req-time           Set time duration between consecutive Transmit Stream Measurement
                        Requests. Range: 10-200 sec,Default: 90 sec, Turn-Off:0 0

```

Working with Radio Resource Management Information Elements

ArubaOS supports the following radio resource management information elements (RRM IEs) for APs with 802.11k support enabled. These settings can be enabled through the WebUI or CLI.

To select the RRM IEs to be sent in beacons and probe responses using the WebUI:

1. Navigate to **Configuration > Advanced Services > All Profile Management**.
2. Expand the **Wireless LAN** menu and select **RRM IE**.
3. Select the RRM IE profile you want to configure, then select any of the following IE types to enable that information element in beacons and probe responses. (All IE types are sent by default.)

Table 91: RRM IEParameters

Parameter	Description
Advertise Enabled Capabilities IE	This value is used to determine if the RRM Enabled Capabilities IE should be advertised in the beacon frames. A value of "Enabled" allows the RRM Enabled Capabilities IE to be present in the beacon frames when 802.11K capability is enabled. A value of "Disabled" prevents the advertisement of the RRM Enabled Capabilities IE in the beacon frames when 802.11K capability is enabled.
Advertise Country IE	This value is used to determine if the Country IE should be advertised in the beacon frames. A value of "Enabled" allows the Country IE to be present in the beacon frames when 802.11K capability is enabled. A value of "Disabled" prevents the advertisement of the Country IE in the beacon frames when 802.11K capability is enabled.
Advertise Power Constraint IE	This value is used to determine if the Power Constraint IE should be advertised in the beacon frames. A value of "Enabled" allows the Power Constraint IE to be present in the beacon frames when 802.11K capability is enabled. A value of "Disabled" prevents the advertisement of the Power Constraint IE in the beacon frames when 802.11K capability is enabled.
Advertise TPC Report IE	This value is used to determine if the TPC Report IE should be advertised in the beacon frames. A value of "Enabled" allows the TPC Report IE to be present in the beacon frames when 802.11K capability is enabled. A value of "Disabled" prevents the advertisement of the TPC Report IE in the beacon frames when 802.11K capability is enabled.
Advertise QBSS Load IE	This value is used to determine if the QBSS Load IE should be advertised in the beacon frames. A value of "Enabled" allows the QBSS Load IE to be present in the beacon frames when 802.11K capability is enabled. A value of "Disabled" prevents the advertisement of the QBSS Load IE in the beacon frames when 802.11K capability is enabled. The default value is "Enabled".

Parameter	Description
Advertise BSS AAC IE	This value is used to determine if the BSS Available Admission Capacity IE should be advertised in the beacon frames. A value of "Enabled" allows the BSS Available Admission Capacity IE to be present in the beacon frames when 802.11K capability is enabled. A value of "Disabled" prevents the advertisement of the BSS Available Admission Capacity IE in the beacon frames when 802.11K capability is enabled.
Advertise Quiet IE	This value is used to determine if the Quiet IE should be advertised in the beacon frames. A value of "Enabled" allows the Quiet IE to be present in the beacon frames when 802.11K capability is enabled. A value of "Disabled" prevents the advertisement of the Quiet IE in the beacon frames when 802.11K capability is enabled.

4. Click **Apply Changes** to save your settings.

To use the CLI to configure radio resource management information elements in the RRM IE profile, access the CLI in config mode and issue the following commands:

```
wlan rrm-ie-profile <profile>
  bss-aac-ie
  clone
  country-ie
  enabled-capabilities-ie
  no...
  pwr-constraint-ie
  qbss-load-ie
  quiet-ie
  tpc-report-ie
```

Working with Beacon Report Requests

The beacon report requests are sent only to dot11k compliant clients that advertise Beacon Report Capability in their RRM Enabled Capabilities IE. The beacon request frames are sent every 60 seconds.

The content of the report requests can be defined in the Beacon Report Request profile using the WebUI or CLI.

To select the information to be sent in beacon report requests using the WebUI:

1. Navigate to **Configuration > Advanced Services > All Profile Management**.
2. Expand the **Wireless LAN** menu and select **Beacon Report Request**.
3. Select the Beacon Report Request profile you want to configure.
4. Define the settings described in the table below, then click **Apply Changes** to save your settings.

Table 92: *Beacon Report Request Settings*

Parameter	Description
Interface	This field is used to specify the Radio interface for transmitting the Beacon Report Request frame. It can have a value of either 0 or 1. The default value is 1.
Regulatory Class	This option is used to specify the Regulatory Class field in the Beacon Report Request frame. It can be set to one of the following: - <ul style="list-style-type: none"> ● 5 (for 5 GHz band) ● 12 (for 2.4 GHz band)
Channel	This option is used to set the Channel field in the Beacon Report Request frame. The Channel value can be set to one of the following: - the channel of the AP (when Measurement Mode

Parameter	Description
	is set to either 'Passive' or 'Active-All channels') - 0 (when Measurement Mode is set to 'Beacon Table') - 255 (when Measurement Mode is set to 'Active-Channel Report')
Randomization Interval	This value is used to set the Randomization Interval field in the Beacon Report Request frame. The Randomization Interval is used to specify the desired maximum random delay in the measurement start time. It is expressed in units of TUs (Time Units). A Randomization Interval of 0 in a measurement request indicates that no random delay is to be used. This field can be given a value in the range (0, 65535). The default value is 0.
Measurement Duration	This value is used to set the Measurement Duration field in the Beacon Report Request frame. The Measurement Duration is set to the duration of the requested measurement. It is expressed in units of TUs. This field can be given a value in the range (0, 65535). The default value is 0.
Measurement Mode for Beacon Reports	Click the Measurement Mode for Beacon Reports drop-down list and specify one of the following measurement modes: <ul style="list-style-type: none"> ● active—Enables active beacon measurement mode. In this mode, the client sends a probe request to the broadcast destination address on all supported channels, sets a measurement duration timer, and, at the end of the measurement duration, compiles all received beacons or probe response with the requested SSID and BSSID into a measurement report. ● beacon-table—Enables beacon-table beacon measurement mode. In this mode, the client measures beacons and returns a report with stored beacon information for any supported channel with the requested SSID and BSSID. The client does not perform any additional measurements. ● passive—Enables passive beacon measurement mode. In this mode, the client sets a measurement duration timer, and, at the end of the measurement duration, compiles all received beacons or probe response with the requested SSID and BSSID into a measurement report. <p>NOTE: If a station doesn't support the selected measurement mode, it returns a Beacon Measurement Report with the Incapable bit set in the Measurement Report Mode field. Default Mode: beacon-table</p>
Reporting Condition	This option is used to indicate the value for the "Reporting Condition" field in the Beacon Reporting Information sub-element present in the Beacon Report Request frame. It can have a range from 0 to 255. The default value is 0.
ESSID name	This option is used to indicate the value for the "SSID" field in the Beacon Report Request frame. It corresponds to the SSID Name for which the Beacon Report Request frame needs to be generated. It is a string with a minimum length of 1 and a maximum length of 32.
Reporting Detail	This option is used to indicate the value for the "Detail" field in the Reporting Detail sub-element present in the Beacon Report Request frame. It is set to "Disabled" by default.
Measurement Duration Mandatory	This value is used to set the "Duration Mandatory" bit of the Measurement Request Mode field of the Beacon Report Request frame. The default value is "Disabled".
Request Information values	This option is used to indicate the contents of the Request Information IE that could be present in the Beacon Report Request frame. The Request Information IE is present for all Measurement Modes except the 'Beacon Table' mode. It consists of a list of Element IDs that should be included by the client in the response frame.

To select the information to be sent in beacon report requests using the command-line interface, access the CLI in config mode and issue the following commands.

```
wlan bcn-rpt-req-profile <profile>
  channel <channel>
  clone <profile>
  interface <interface>
  measure-dur-mandatory
```

```

measure-duration <measure-duration>
measure-mode active-all-ch|active-ch-rpt|beacon-table|passive
no...
random-interval <random-interval>
reg-class 1|12
request-info <requestinfo>
rpt-condition <rpt-condition>
rpt-detail
ssid <ssid>

```

Working with a Traffic Stream Measurement Report

The Traffic Stream Measurement (TSM) report requests are sent only to dot11k compliant clients that advertise a traffic stream report capability. The TSM report request frames are sent every 60 seconds. The content of the report requests can be defined in the TSM Report Request profile using the WebUI or CLI. To select the information to be sent in TSM report requests using the WebUI:

1. Navigate to **Configuration > Advanced Services > All Profile Management**.
2. Expand the **Wireless LAN** menu and select **TSM Report Request**.
3. Select the TSMReport Request profile you want to configure.
4. Define the settings described in the table below, then click **Apply Changes** to save your settings.

Table 93: TSM Report Request Settings

Parameter	Description
Request Mode for TSM Report Request	<p>Select one of the following request modes:</p> <ul style="list-style-type: none"> • normal • triggered <p>This value is used to determine the request mode for the Transmit Stream/Category Measurement Request frame. A Transmit Stream/Category Measurement Request frame can be sent in either "normal" mode or "triggered" mode. There are two options for this field - "normal" and "triggered". When the "triggered" option is selected, the Transmit Stream/Category Measurement Request frame is sent only when the trigger condition occurs. The default value for this field is "normal".</p>
Number of repetitions	<p>This value is used to set the "Number of Repetitions" field in the Transmit Stream/Category Measurement Request frame. The Number of Repetitions field contains the requested number of repetitions for all the Measurement Request elements in this frame. A value of zero in this field indicates Measurement Request elements are executed once without repetition. A value of 65535 in the Number of Repetitions field indicates Measurement Request elements are repeated until the measurement is cancelled or superseded. This field has values in the range (0, 65535). The default value is 65535.</p>
Duration Mandatory	<p>This value is used to set the "Duration Mandatory" bit of the Measurement Request Mode field of the Transmit Stream/Category Measurement Request frame. The default value is "enabled".</p>
Randomization Interval	<p>This value is used to set the Randomization Interval field in the Transmit Stream/Category Measurement Request frame. The Randomization Interval is used to specify the desired maximum random delay in the measurement start time. It is expressed in units of TUs (Time Units). When the request mode for the Transmit Stream/Category Measurement Request</p>

Parameter	Description
	frame is set to "triggered", the Randomization Interval is not used and is set to 0. A Randomization Interval of 0 in a measurement request indicates that no random delay is to be used. This field can be given a value in the range (0, 65535). The default value is 0.
Measurement Duration	This value is used to set the Measurement Duration field in the Transmit Stream/Category Measurement Request frame. The Measurement Duration is set to the duration of the requested measurement. It is expressed in units of TUs. When the request mode for the Transmit Stream/Category Measurement Request frame is set to "triggered", the Measurement Duration field should be set to 0. This field can be given a value in the range (0, 65535). The default value is 9776.
Traffic ID	The value is used to set the Traffic Identifier field in the Transmit Stream/Category Measurement Request frame. The Traffic Identifier field contains the TID subfield. The TID subfield indicates the TC or TS for which traffic is to be measured. This field can be given a value in the range (0, 255). The default value is 96
Bin 0 Range	This value is used to set the 'Bin 0 Range' field in the Transmit Stream/Category Measurement Request frame. Bin 0 Range indicates the delay range of the first bin (Bin 0) of the Transmit Delay Histogram, expressed in units of TUs. This field can be given a value in the range (0, 255). The default value is 6.

To select the information to be sent in TSM report requests using the command-line interface, access the CLI in config mode and issue the following commands.

```
wlan tsm-req-profile <default>
  bin0-range <bin0-range>
  clone <prfoile>
  dur-mandatory
  measure-duration <measure-duration>
  no
  num-repeats <num-repeats>
  random-interval <random-interval>
  request-mode normal|triggered
  traffic-id <traffic-id>
```

Configuring a High-Throughput Virtual AP

With the implementation of the IEEE 802.11n standard, high-throughput can be configured to operate on the 5 GHz and/or 2.4 GHz frequency band.

The high-throughput SSID profile configures the high-throughput SSID settings. Stations are not allowed to use high-throughput with TKIP standalone encryption, although TKIP can be provided in mixed-mode BSSIDs that support high-throughput. High-throughput is disabled on a BSSID if the encryption mode is standalone TKIP or WEP.

De-aggregation of MAC Service Data Units (A-MSDUs) is supported on the W-3000 Series, W-7200 Series, and the W-6000M3 Dell controllers with a maximum frame transmission size of 4k bytes; however, this feature is always enabled and is not configurable. Aggregation is not currently supported.

For high-throughput to function on a virtual AP profile for the assigned AP group or specific AP, high-throughput must be enabled within the assigned ht-ssid-profile and the radio-profile(s) for the desired frequency band(s).

By default, high-throughput is enabled; however, the examples in this section guide you through manually creating profiles and enabling high-throughput on the 5 GHz and 2.4 GHz frequency bands to ensure proper functionality of a virtual AP profile named “ht-vap-corpnet” assigned to an existing AP group named “ht-corpnet-aps.”



NOTE: For an example of 20 MHz channel versus 40 MHz channel pair configuration, see “20 MHz and 40 MHz Static Channel Assignments” on page 157.

This example includes the following tasks:

- Create two high-throughput radio profiles named “ht-radioa-corpnet” and “ht-radiog-corpnet.”
- Create and configure a 5 GHz radio profile named “ht-corpnet-a” and assign the high-throughput radio profile named “ht-radioa-corpnet.”
- Create and configure a 2.4 GHz radio profile named “ht-corpnet-g” and assign the high-throughput radio profile named “ht-radiog-corpnet.”
- Create and configure a high-throughput SSID profile named “ht-ssid-corpnet.”
- Create an SSID profile named “ht-corpnet” and assign the high-throughput SSID profile named “ht-ssid-corpnet.”
- Create a virtual AP profile named “ht-vap-corpnet” and assign the SSID profile named “ht-corpnet.”
- Assign the required profiles to an existing AP group named “ht-corpnet-ap.”

The following procedures are presented for the WebUI and the CLI.

In the WebUI

1. Navigate to **Configuration > Wireless > AP Configuration > AP Group** page.
2. Click **Edit** for the AP group ht-corpnet-ap.
3. Under the Profiles list, select **RF Management** to display the radio profiles.
4. Select the **802.11a radio profile**.



NOTE: This radio profile represents activity on the 5 GHz frequency band. Since the high-throughput IEEE 802.11n standard operates on the 5 GHz and/or 2.4 GHz frequency band, high-throughput can be enabled on 802.11a or 802.11g radio profiles.

- a. Select **New** from the 802.11a radio profile drop-down menu.
 - b. Enter **ht-corpnet-a** for the 802.11a radio profile name.
 - c. Select (check) the **High Throughput enable (radio)** checkbox to enable high-throughput. By default, this is enabled (checked).
 - d. Click **Apply**.
5. Select the **High-throughput Radio Profile** under the 802.11a radio profile.
 - a. Select **New** from the **High-throughput Radio Profile** drop-down menu.
 - b. Enter for the high-throughput radio profile name. **ht-radioa-corpnet**
 - c. Configure the high-throughput radio settings (see [Table 94](#) for details) and click **Apply**.

Table 94: *High-Throughput Radio Profile Configuration Parameters*

Parameter	Description
40MHz intolerance	This parameter controls whether or not APs using this radio profile will advertise intolerance of 40 MHz operation. By default, this option is disabled, and 40 MHz operation

Parameter	Description
	is allowed. If you do not want to use 40 Mhz operation, select the 40MHz intolerance checkbox to enable this feature.
honor 40MHz intolerance	When enabled, the radio will stop using the 40 MHz channels if the 40 MHz intolerance indication is received from another AP or station. Uncheck the Honor 40 Mhz intolerance checkbox to disable this feature. Default: Enabled
Diversity Spreading Workaround	Most transmissions to high throughput (HT) stations are sent through multiple antennas using cyclic shift diversity (CSD). When you enable the Diversity Spreading Workaround parameter, CSD is disabled and only one antenna transmits data, even if they are being sent to high-throughput stations. This enables interoperability for legacy or high-throughput stations that cannot decode 802.11n CDD data. This option is disabled by default, and should only be enabled under the supervision of Dell technical support. Use this feature to turn off antenna diversity when the AP must support legacy clients such as Cisco 7921g VoIP phones, or older 802.11g clients (e.g. Intel Centrino clients). Note, however, that enabling this feature can reduce overall throughput rates.

6. Select the 802.11g radio profile.



NOTE: This radio profile represents activity on the 2.4 GHz frequency band. Since the high-throughput IEEE 802.11n standard operates on the 5 GHz and/or 2.4 GHz frequency band, high-throughput can be enabled on 802.11a or 802.11g radio profiles.

- a. Select **New** from the 802.11g radio profile drop-down menu.
 - b. Enter **ht-corpnet-g** for the 802.11a radio profile name.
 - c. Select (check) the **High Throughput enable (radio)** checkbox to enable high-throughput. By default, this is enabled (checked).
 - d. Click **Apply**.
7. Select the **High-throughput Radio Profile** under the 802.11g radio profile.
- a. Select **New** from the **High-throughput Radio Profile** drop-down menu.
 - b. Enter **ht-radiog-corpnet** for the high-throughput radio profile name.
 - c. Configure the high-throughput radio settings (see [Table 94](#) for details) and Click **Apply**.
8. Select **Wireless LAN**, under the Profiles list, to reveal the WLAN profiles.
9. Select the **Virtual AP** profile.
- a. Select **New** from the **Add a Profile** drop-down menu.
 - b. Enter **ht-vap-corpnet** for the virtual AP profile name.
 - c. Click **Add**.
 - d. Select **New** from the **SSID Profile** drop-down menu associated with the “ht-vap-corpnet” virtual AP profile. The SSID Profile dialog box appears.
 - e. Enter **ht-corpnet** for the SSID profile name.
 - f. Click **Apply** to create the SSID profile and return to the virtual AP profile page.
 - g. Click **Apply** on the virtual AP profile page.
10. Select the **ht-vap-corpnet** virtual AP profile.
- a. Select **all** from the **Allowed band** drop-down menu.
 - b. Click **Apply**.
11. Select the SSID profile **ht-corpnet**. The High-throughput SSID profile option will appear below **ht-corpnet** in the profiles list.

12. Select the **High-throughput SSID Profile**.

- a. Select **New** from the **High-throughput SSID Profile** drop-down menu.
- b. Enter **ht-ssid-corpnet** for the high-throughput SSID profile name.
- c. Configure the high-throughput SSID profile settings (see [Table 95](#) for details).

The High-Throughput SSID profile configuration settings are divided into two tabs, **Basic** and **Advanced**. The **Basic** tab displays only those configuration settings that often need to be adjusted to suit a specific network. The **Advanced** tab shows all configuration settings, including settings that do not need frequent adjustment or should be kept at their default values. If you change a setting on one tab then click and display the other tab without saving your configuration, that setting will revert to its previous value. Both basic and advanced settings are described in [Table 54](#).

- d. Click **Apply** to assign it to the SSID profile.

Table 95: High-Throughput SSID Profile Parameters

Parameter	Description
Basic High-Throughput SSID Profile Settings	
40 MHz channel usage	Enable or disable the use of 40 MHz channels. This parameter is enabled by default.
Advanced High-Throughput SSID Profile Settings	
BA AMSDU Enable	Enable/Disable Receive AMSDU in BA negotiation.
Legacy stations	Allow or disallow associations from legacy (non-HT) stations. By default, this parameter is enabled (legacy stations are allowed).
Low-density Parity Check	If enabled, the AP will advertise Low-density Parity Check (LDPC) support. LDPC improves data transmission over radio channels with high levels of background noise.
Maximum number of spatial streams usable for STBC reception	Controls the maximum number of spatial streams usable for STBC reception. 0 disables STBC reception, 1 uses STBC for MCS 0-7. Higher MCS values are not supported. (Supported on the W-AP90 series, W-AP130 Series, W-AP68, W-AP175 Series and W-AP105 only. The configured value will be adjusted based on AP capabilities.)
Maximum number of spatial streams usable for STBC transmission.	Controls the maximum number of spatial streams usable for STBC transmission. 0 disables STBC transmission, 1 uses STBC for MCS 0-7. Higher MCS values are not supported. (Supported on W-AP90 series, W-AP175 Series, W-AP130 Series and W-AP105 only. The configured value will be adjusted based on AP capabilities.)
MPDU Aggregation	Enable or disable MAC protocol data unit (MPDU) aggregation. High-throughput APs are able to send aggregated MAC protocol data units (MDPUs), which allow an AP to receive a single block acknowledgment instead of multiple ACK signals. This option, which is enabled by default, reduces network traffic overhead by effectively eliminating the need to initiate a new transfer for every MPDU.
Max received A-MPDU size	Maximum size of a received aggregate MPDU, in bytes. Allowed values: 8191, 16383, 32767, 65535.
Max transmitted A-MPDU size	Maximum size of a transmitted aggregate MPDU, in bytes. Range: 1576–65535
Min MPDU start spacing	Minimum time between the start of adjacent MPDUs within an aggregate MPDU, in microseconds. Allowed values: 0 (No restriction on MPDU start spacing), .25 µsec, .5 µsec, 1 µsec, 2 µsec, 4 µsec.

Parameter	Description
Short guard interval in 20 MHz mode	<p>Enable or disable use of short (400ns) guard interval in 20 MHz mode. This parameter is enabled by default.</p> <p>A guard interval is a period of time between transmissions that allows reflections from the previous data transmission to settle before an AP transmits data again. An AP identifies any signal content received inside this interval as unwanted inter-symbol interference, and rejects that data. The 802.11n standard specifies two guard intervals: 400ns (short) and 800ns (long). Enabling a short guard interval can decrease network overhead by reducing unnecessary idle time on each AP. Some outdoor deployments, may, however require a longer guard interval. If the short guard interval does not allow enough time for reflections to settle in your mesh deployment, inter-symbol interference values may increase and degrade throughput.</p>
Short guard interval in 40 MHz mode	<p>Enable or disable use of short (400ns) guard interval in 40 MHz mode. This parameter is enabled by default.</p> <p>A guard interval is a period of time between transmissions that allows reflections from the previous data transmission to settle before an AP transmits data again. An AP identifies any signal content received inside this interval as unwanted inter-symbol interference, and rejects that data. The 802.11n standard specifies two guard intervals: 400ns (short) and 800ns (long). Enabling a short guard interval can decrease network overhead by reducing unnecessary idle time on each AP. Some outdoor deployments, may, however require a longer guard interval. If the short guard interval does not allow enough time for reflections to settle in your mesh deployment, inter-symbol interference values may increase and degrade throughput.</p>
Supported MCS set	<p>A list of Modulation Coding Scheme (MCS) values or ranges of values to be supported on this SSID. The MCS you choose determines the channel width (20MHz vs. 40MHz) and the number of spatial streams used by the mesh node.</p> <p>The default value is 1–23; the complete set of supported values. To specify a smaller range of values, enter a hyphen between the lower and upper values. To specify a series of different values, separate each value with a comma.</p> <p>Examples: 2–10 1,3,6,9,12 Range: 0–23.</p>

In the CLI

```
(host) (config) #rf ht-radio-profile ht-radioa-corpnet
(host) (config) #rf ht-radio-profile ht-radiog-corpnet
(host) (config) #rf dot11a-radio-profile ht-corpnet-a
    high-throughput-enable
    ht-radio-profile ht-radioa-corpnet
(host) (config) #rf dot11g-radio-profile ht-corpnet-g
    high-throughput-enable
    ht-radio-profile ht-radiog-corpnet
(host) (config) #wlan ht-ssid-profile ht-ssid-corpnet
    high-throughput-enable
(host) (config) #wlan ssid-profile ht-corpnet
    ht-ssid-profile ht-ssid-corpnet
(host) (config) #wlan virtual-ap ht-vap-corpnet
    allowed-bands all
    ssid-profile ht-corpnet
(host) (config) #ap-group ht-corpnet-ap
    dot11a-radio-profile ht-corpnet-a
    dot11g-radio-profile ht-corpnet-g
    virtual-ap ht-vap-corpnet
```

Managing High-Throughput Profiles

Use the following commands to create a high-throughput radio profile or edit an existing profile. For details, see [Table 94](#).

```
(host) (config) #rf ht-radio-profile <profile>
  40MHz-intolerance
  clone <profile>
  honor-40MHz-intolerance
  no
  disable-diversity-spreading
```

Use the following commands to create a high-throughput SSID profile or edit an existing profile. For details, see [Table 95](#).

```
(host) (config) #wlan ht-ssid-profile <profile>
  40MHz-enable
  clone <profile>
  high-throughput-enable
  ldpc
  legacy-stations
  max-rx-a-mpdu-size {8191|16383|32767|65535}
  max-tx-a-mpdu-size <bytes>
  min-mpdu-start-spacing {0|.25|.5|1|2|4|8|16}
  mpdu-agg
  no...
  short-guard-intvl-20MHz
  short-guard-intvl-40MHz
  STBC-rx-streams
  STBC-tx-streams
  supported-mcs-set <mcs-list>
```

In the WebUI

Chapter 21

Adaptive Radio Management (ARM)

This section describes how to configure the ARM function to automatically select the best channel and transmission power settings for each AP on your WLAN. After completing the tasks described in the following pages, you can continue configuring your APs as described in the *Dell PowerConnect W-Series ArubaOS 6.2 User Guide*.

The documentation for this feature includes the following topics:

- ["Understanding ARM" on page 346](#)
- ["Configuring ARM Profiles" on page 348](#)
- ["Assigning an ARM Profile to an AP Group" on page 355](#)
- ["Using Multi-Band ARM for 802.11a/802.11g Traffic" on page 356](#)
- ["Enabling Band Steering" on page 356](#)
- ["Enabling Traffic Shaping" on page 358](#)
- ["Enabling Spectrum Load Balancing" on page 359](#)
- ["Reusing Channels to Control RX Sensitivity Tuning" on page 360](#)
- ["Configuring Non-802.11 for Noise Interference Immunity" on page 360](#)
- ["ARM Metrics" on page 361](#)
- ["Troubleshooting ARM" on page 362](#)

Understanding ARM

Dell's Adaptive Radio Management (ARM) technology maximizes WLAN performance even in the highest traffic networks by dynamically and intelligently choosing the best 802.11 channel and transmit power for each Dell AP in its current RF environment.

Dell's ARM technology solves wireless networking challenges such as large deployments, dense deployments, and installations that must support VoIP or mobile users. Deployments with dozens of users per access point can cause network contention and interference, but ARM dynamically monitors and adjusts the network to ensure that all users are allowed ready access. ARM provides the best voice call quality with voice-aware spectrum scanning and call admission control.

With earlier technologies, network administrators would have to perform a site survey at each location to discover areas of RF coverage and interference, and then manually configure each AP according to the results of this survey. Static site surveys can help you choose channel and power assignments for APs, but these surveys are often time-consuming and expensive, and only reflect the state of the network at a single point in time. ARM is more efficient than static calibration, and, unlike older technologies, it continually monitors and adjusts radio resources to provide optimal network performance. Automatic power control can adjust AP power settings if adjacent APs are added, removed, or moved to a new location within the network, minimizing interference with other WLAN networks. ARM adjusts only the affected APs, so the entire network does not require systemic changes.

ARM Support for 802.11n

ArubaOS version 3.3.x or later supports APs with the 802.11n standard, ensuring seamless integration of 802.11n devices into your RF domain. The Dell AP's 5 GHz band capacity simplifies the integration of new APs into your legacy network. You can also replace older APs with newer 802.11n-compliant APs while reusing your existing cabling and PoE infrastructure.

A high-throughput (802.11n) AP can use a 40 MHz channel pair comprised of two adjacent 20 MHz channels available in the regulatory domain profile for your country. When ARM is configured for a dual-band AP, it will dynamically select the primary and secondary channels for these devices. It can, however, continue to scan all changes in the a+b/g bands to calculate interference and detect rogue APs.

Monitoring Your Network with ARM

When ARM is enabled, the Dell AP dynamically scans all 802.11 channels in its regulatory domain at regular intervals and will report everything it sees to the controller on each channel it scans. (By default, 802.11n-capable APs scan channels in all regulatory domains.) This includes, but is not limited to, data regarding WLAN coverage, interference, and intrusion detection. You can retrieve this information from the controller to get a quick health check of your WLAN deployment without having to walk around every part of a building with a network analyzer. (For additional information on the individual matrix gathered on the AP's current assigned RF channel, see ["ARM Metrics" on page 361.](#))

Configuring ARM Scanning

The default ARM scanning interval is determined by the **scan-interval** parameter in the ARM profile. If the AP does not have any associated clients (or if most of its clients are inactive) the ARM feature will dynamically readjust this default scan interval, allowing the AP obtain better information about its RF neighborhood by scanning non-home channels more frequently. Starting with ArubaOS 6.2, if an AP attempts to scan a non-home channel but is unsuccessful, the AP will make additional attempts to rescan that channel before skipping it and continuing on to other channels.

The **ARM Over the Air Updates** parameter allows an AP to get information about its RF environment from its neighbors, even the AP cannot scan. If this feature is enabled, when an AP on the network scans a foreign (non-home) channel, it sends an Over-the-Air (OTA) update in an 802.11 management frame that contains information about that AP's home channel, the current transmission EIRP value of the home channel, and one-hop neighbors seen by that AP.

Understanding ARM Application Awareness

Dell APs keep a count of the number of data bytes transmitted and received by their radios to calculate the traffic load. When a WLAN gets very busy and traffic exceeds a predefined threshold, load-aware ARM dynamically adjusts scanning behavior to maintain uninterrupted data transfer on heavily loaded systems. ARM-enabled APs will resume their complete monitoring scans when the traffic has dropped to normal levels. You can also define a firewall policy that pauses ARM scanning when the AP detects critically important or latency-sensitive traffic from a specified host or network.

ARM's band steering feature encourages dual-band capable clients to stay on the 5GHz band on dual-band APs. This frees up resources on the 2.4GHz band for single band clients like VoIP phones.

The ARM "Mode Aware" option is a useful feature for single radio, dual-band WLAN networks with high density AP deployments. If there is too much AP coverage, those APs can cause interference and negatively impact your network. Mode aware ARM can turn APs into Air Monitors if necessary, then turn those Air Monitors back into APs when they detect gaps in coverage. Note that an Air Monitor will not turn back into an AP if it detects client traffic (or client traffic increases), but will change to an AP only if it detects coverage holes.

Configuring ARM Profiles

You configure ARM by defining ARM *profiles*, a set of configuration parameters that you can apply as needed to an AP group or to individual APs. Dell controllers have one preconfigured ARM profile, called **default**. Most network administrators will find that this one default ARM profile is sufficient to manage all the Dell APs on their WLAN. Others may want to define multiple profiles to suit their APs' varying needs.

When managing ARM profiles, you should first consider whether or not all the APs on your WLAN operate in similar environments and manage similar traffic loads and client types.

If your APs' environment and traffic loads are mostly the same, you can use the default ARM profile to manage all the APs on your WLAN. If you ever modify the default profile, all APs on the WLAN will be updated with the new settings. If, however, you have APs on your WLAN that are in different physical environments, or your APs each manage widely varying client loads or traffic types, you should consider defining additional ARM profiles for your AP groups. The following table describes different WLAN environments, and the type of ARM profiles appropriate for each.

Table 96: ARM Profile Types

ARM Profiles	Example WLAN Description
default profile only	<ul style="list-style-type: none">• A warehouse where the physical environment is nearly the same for all APs, and each AP manages the same number of clients and traffic load.• A training room, where the clients are evenly spaced throughout the room, have the same security requirements and are using the same amount of network resources.
multiple profiles	<ul style="list-style-type: none">• Universities where APs are in different building types (open auditoriums, small brick classrooms), some APs must support VoIP or video streaming, and mobile clients are constantly moving from one AP coverage area to another.• Healthcare environments where some APs must balance the network demands of large digital radiology files, secure electronic patient record transfers, diagnostic videos, and collaborative VoIP sessions, while other APs (like those in a lobby or cafeteria) support only lower-priority traffic like Internet browsing.

You assign ARM profiles to AP groups by associating an ARM profile with that AP group's 802.11a or 802.11g RF management profile. For details on associating an ARM profile with an AP group, see "Assigning an ARM Profile to an AP Group" on page 362.

There are two ways to create a new ARM profile. You can make an entirely new profile with all default settings, or you can create a new profile based upon the settings of an existing profile by making a copy of that other profile.

Creating a New ARM Profile

To create a new ARM profile with all default settings via the WebUI:

1. Select **Configuration > All Profiles**. The **All Profile Management** window opens.
2. Select **RF Management** to expand the **RF Management** section.
3. Select **Adaptive Radio Management (ARM) Profile**. Any currently defined ARM profiles appears in the right pane of the window. If you have not yet created any ARM profiles, this pane displays the **default** profile only.
4. To create a new profile with all default settings, enter a name in the entry blank. The name must be 1–63 characters, and can be composed of alphanumeric characters, special characters and spaces. If your profile name includes a space, it must be enclosed within quotation marks.
5. Click **Add**.

To create a new ARM profile via the command-line interface, access the CLI in config mode and issue the following command.

```
(host) (config) #rf arm-profile <profile>
```

where <profile> is a unique name for the new ARM profile. The name must be 1–63 characters, and can be composed of alphanumeric characters, special characters and spaces. If your profile name includes a space, it must be enclosed within quotation marks

Copying an Existing Profile

To create a new ARM profile based upon the settings of another existing profile:

1. Follow steps 1–3 in the above procedure to access the **Adaptive Radio Management (ARM) profile** window.
2. From the list of profiles, select the profile with the settings you would like to copy.
3. Click **Save As**.
4. Enter a name for the new profile in the entry blank. The name must be 1–63 characters, and can be composed of alphanumeric characters, special characters and spaces.
5. Click **Apply**.

To create a copy of an existing ARM profile via the command-line interface, access the CLI in config mode and issue the following command.

```
(host) (config) #rf arm-profile <newprofile> clone <profile>
```

where <newprofile> is a unique name for the new ARM profile, and <profile> is the name of the existing profile whose setting you want to copy.

Deleting a Profile

You can only delete unused ARM profiles; Dell will not let you delete an ARM profile that is currently assigned to an AP group.

To delete an ARM profile In the WebUI:

1. Select **Configuration > All Profiles**. The **All Profile Management** window opens.
2. Select **RF Management** to expand the **RF Management** section.
3. Select **Adaptive Radio Management (ARM) Profile**.
4. Select the name of the profile you want to delete.
5. Click **Delete**.

To delete an ARM profile using the CLI, issue the command

```
(host) (config) #no rf arm-profile <profile>
```

where <profile> is the name of the ARM profile you wish to remove.

Configuring ARM Settings

ARM profile settings are divided into two categories; **Basic** and **Advanced**. The Basic ARM settings include ARM scanning checkbox and general configuration parameters such as channel and power assignments and minimum and maximum allowed EIRP values. Most network environments do not require any changes to the advanced ARM configuration settings. If, however, your network supports a large amount of VoIP or Video traffic, or if you have unusually high security requirements you may want to manually adjust the basic ARM thresholds.

In the WebUI

To change an ARM profile:

1. Select **Configuration > All Profiles**. The **All Profile Management** window opens.
2. Select **RF Management** to expand the **RF Management** section.

3. Select **Adaptive Radio Management (ARM) Profile**.
4. Select the name of the profile you want to edit. The **Adaptive Radio Management (ARM) profile** window opens.

Configuration settings are divided into two tabs, **Basic** and **Advanced**. The **Basic** tab displays only those configuration settings that often need to be adjusted to suit a specific network. The **Advanced** tab shows all configuration settings, including settings that do not need frequent adjustment or should be kept at their default values. If you change a setting on one tab then click and display the other tab without saving your configuration, that setting will revert to its previous value. Both basic and advanced ARM configuration parameters are described in [Table 97](#).

5. Change any of the settings described in the table below, then click **Apply** to save your changes.

Table 97: ARM Profile Configuration Parameters

Setting	Description
Basic Configuration Settings	
Assignment	<p>Activates one of four ARM channel/power assignment modes. (The default value is single-band.)</p> <ul style="list-style-type: none"> ● disable: Disables ARM calibration and reverts APs back to default channel and power settings specified by the AP's radio profile ● maintain: APs maintain their current channel and power settings. This setting can be used to maintain AP channel and power levels after ARM has initially selected the best settings. ● multi-band: For single-radio APs, this value computes ARM assignments for both 5 GHz (802.11a) and 2.4 GHz (802.11b/g) frequency bands. ● single-band: For dual-radio APs, this value enables APs to change transmit power and channels within their same frequency band, and to adapt to changing channel conditions.
Allowed bands for 40MHz channels	The specified setting allows ARM to determine if 40 MHz mode of operation is allowed on the 5 GHz or 2.4 GHz frequency band only, on both frequency bands, or on neither frequency band.
Max Tx EIRP	<p>Maximum effective isotropic radiated power (EIRP) from 3 to 33 dBm in 3 dBm increments. You may also specify a special value of 127 dBm for regulatory maximum. Higher power level settings may be constrained by local regulatory requirements and AP capabilities. In the event that an AP is configured for a Max Tx EIRP setting it cannot support, this value will be reduced to the highest supported power setting. The default value for this parameter is 127 dBm.</p> <p>NOTE: Power settings will not change if the Assignment option is set to disabled or maintain.</p>
Min Tx EIRP	<p>Minimum effective isotropic radiated power (EIRP) from 3 to 33 dBm in 3 dBm increments. You may also specify a special value of 127 dBm for regulatory maximum to disable power adjustments for environments such as outdoor mesh links. Note that power settings will not change if the Assignment option is set to disabled or maintain. Higher power level settings may be constrained by local regulatory requirements and AP capabilities. In the event that an AP is configured for a Min Tx EIRP setting it cannot support, this value will be reduced to the highest supported power setting. The default value for this parameter is 9 dBm.</p> <p>Consider configuring a Min Tx Power setting higher than the default value if most of your APs are placed on the ceiling. APs on a ceiling often have good line of sight between them, which will cause ARM to decrease their power to prevent interference. However, if the wireless clients down on the floor do not have such a clear line back to the AP, you could end up with coverage gaps.</p>
Scanning	<p>The Scanning checkbox enables or disables AP scanning across multiple channels. This checkbox is selected by default. Do not disable scanning unless you want to disable ARM and manually configure AP channel and transmission power. Disabling this option also disables the following scanning features:</p> <ul style="list-style-type: none"> ● Multi Band Scan ● Rogue AP Aware ● Voip Aware Scan ● Power Save Scan

Setting	Description
VoIP Aware Scan	Dell's VoIP Call Admission Control (CAC) prevents any single AP from becoming congested with voice calls. When you enable CAC, you should also enable VoIP Aware Scan in the ARM profile, so the AP will not attempt to scan a different channel if one of its clients has an active VoIP call. This option requires that Scanning is also enabled. Default: disabled
Power Save Aware Scan	If enabled, the AP will not scan a different channel if it has one or more clients that is in power save mode. Default: disabled
Video Aware Scan	As long as there is at least one video frame every 100 mSec the AP will reject an ARM scanning request. Note that for each radio interface, video frames must be defined in one of two ways: <ul style="list-style-type: none"> Classify the frame as video traffic via a session ACL. Enable WMM on the WLAN's SSID profile and define a specific DSCP value as a video stream. Next, create a session ACL to tag the video traffic with the that DSCP value.
Minimum Scan Time	Minimum number of times a channel must be scanned before it is considered for assignment. The supported range for this setting is 0–2,147,483,647 scans. Dell recommends a Minimum Scan Time between 1–20 scans. Default: 8 scans
Scan Mode	By default, 802.11n-capable APs scan channels within all regulatory domains. To limit the AP scans to just the regulatory domain for that AP, click the Scan Mode drop-down list and select reg-domain . NOTE: This setting does not apply to APs that do not support 802.11n; these APs will scan their regulatory domain only.
Advanced Configuration Settings	
Assignment	Activates one of four ARM channel/power assignment modes. <ul style="list-style-type: none"> disable: Disables ARM calibration and reverts APs back to default channel and power settings specified by the AP's radio profile maintain: APs maintain their current channel and power settings. This setting can be used to maintain AP channel and power levels after ARM has initially selected the best settings. multi-band: For single-radio APs, this value computes ARM assignments for both 5 GHz (802.11a) and 2.4 GHz (802.11b/g) frequency bands. single-band: For dual-radio APs, this value enables APs to change transmit power and channels within their same frequency band, and to adapt to changing channel conditions. Default: single-band
Allowed bands for 40MHz channels	The specified setting allows ARM to determine if 40 MHz mode of operation is allowed on the 5 GHz or 2.4 GHz frequency band only, on both frequency bands, or on neither frequency band.
Client Aware	If the Client Aware option is enabled, the AP does not change channels if there is an active client associated to that AP. (Activity is defined by the sta-inactivity-time parameter in the IDS general profile. By default, a client is considered active if it has sent or received traffic within the last 60 seconds.) If Client Aware is disabled, the AP may change to a more optimal channel, but this change may also disrupt current client traffic. Default: enabled
Max Tx EIRP	Maximum effective isotropic radiated power (EIRP) from 3 to 33 dBm in 3 dBm increments. You may also specify a special value of 127 dBm for regulatory maximum. Higher power level settings may be constrained by local regulatory requirements and AP capabilities. In the event that an AP is configured for a Max Tx EIRP setting it cannot support, this value will be reduced to the highest supported power setting. Default: 127 dBm NOTE: Power settings will not change if the Assignment option is set to disabled or maintain .

Setting	Description
Min Tx EIRP	<p>Minimum effective isotropic radiated power (EIRP) from 3 to 33 dBm in 3 dBm increments. You may also specify a special value of 127 dBm for regulatory maximum to disable power adjustments for environments such as outdoor mesh links. Note that power settings will not change if the Assignment option is set to disabled or maintain. Higher power level settings may be constrained by local regulatory requirements and AP capabilities. In the event that an AP is configured for a Min Tx EIRP setting it cannot support, this value will be reduced to the highest supported power setting.</p> <p>Default: 9 dBm</p> <p>NOTE: Consider configuring a Min Tx Power setting higher than the default value if most of your APs are placed on the ceiling. APs on a ceiling often have good line of sight between them, which will cause ARM to decrease their power to prevent interference. However, if the wireless clients down on the floor do not have such a clear line back to the AP, you could end up with coverage gaps.</p>
Multi Band Scan	<p>If enabled, single radio channel APs scans for rogue APs across multiple channels. This option requires that Scanning is also enabled.</p> <p>(The Multi Band Scan option does not apply to APs that have two radios, as these devices already scan across multiple channels. If one of these dual-radio devices are assigned an ARM profile with Multi Band enabled, that device will ignore this setting.)</p> <p>Default: disabled</p>
Rogue AP Aware	<p>If you have enabled both the Scanning and Rogue AP options, Dell APs may change channels to contain off-channel rogue APs with active clients. This security features allows APs to change channels even if the Client Aware setting is disabled.</p> <p>This setting is disabled by default, and should only be enabled in high-security environments where security requirements are allowed to consume higher levels of network resources. You may prefer to receive Rogue AP alerts via SNMP traps or syslog events.</p> <p>Default: disabled</p>
Scan Interval	<p>If Scanning is enabled, the Scan Interval defines how often the AP will leave its current channel to scan other channels in the band.</p> <p>Off-channel scanning can impact client performance. Typically, the shorter the scan interval, the higher the impact on performance. If you are deploying a large number of new APs on the network, you may want to lower the Scan Interval to help those APs find their optimal settings more quickly. Raise the Scan Interval back to its default setting after the APs are functioning as desired.</p> <p>The supported range for this setting is 0–2,147,483,647 seconds.</p> <p>Default: 10 seconds</p>
Active Scan	<p>When the Active Scan checkbox is selected, an AP initiates active scanning via probe request. This option elicits more information from nearby APs, but also creates additional management traffic on the network. Active Scan is disabled by default, and should <i>not be enabled</i> except under the direct supervision of Dell Support.</p> <p>Default: disabled</p>
ARM Over the Air Updates	<p>The ARM Over the Air Updates option allows an AP to get information about its RF environment from its neighbors, even the AP cannot scan. If this feature is enabled, when an AP on the network scans a foreign (non-home) channel, it sends other APs an Over-the-Air (OTA) update in an 802.11 management frame that contains information about the scanning AP's home channel, the current transmission EIRP value of its home channel, and one-hop neighbors seen by that AP.</p> <p>Default: enabled</p>
Scanning	<p>The Scanning checkbox enables or disables AP scanning across multiple channels. Disabling this option also disables the following scanning features:</p> <ul style="list-style-type: none"> ● Multi Band Scan ● Rogue AP Aware ● Voip Aware Scan ● Power Save Scan <p>Do not disable Scanning unless you want to disable ARM and manually configure AP channel and transmission power.</p>

Setting	Description
	Default: enabled
VoIP Aware Scan	Dell's VoIP Call Admission Control (CAC) prevents any single AP from becoming congested with voice calls. When you enable CAC, you should also enable VoIP Aware Scan in the ARM profile, so the AP will not attempt to scan a different channel if one of its clients has an active VoIP call. This option requires that Scanning is also enabled. Default: disabled
Power Save Aware Scan	If enabled, the AP will not scan a different channel if it has one or more clients that is in power save mode. Default: disabled
Video Aware Scan	As long as there is at least one video frame every 100 mSec the AP will reject an ARM scanning request. Note that for each radio interface, video frames must be defined in one of two ways: <ul style="list-style-type: none"> • Classify the frame as video traffic via a session ACL. • Enable WMM on the WLAN's SSID profile and define a specific DSCP value as a video stream. Next, create a session ACL to tag the video traffic with the that DSCP value.
Ideal Coverage Index	The Dell coverage index metric is a weighted calculation based on the RF coverage for all DellAPs and neighboring APs on a specified channel. The Ideal Coverage Index specifies the ideal coverage that an AP should try to achieve on its channel. The denser the AP deployment, the lower this value should be. The range of possible values is 2–20. Default: 10 For additional information on how this the Coverage Index is calculated, see "ARM Metrics" on page 361
Acceptable Coverage Index	For multi-band implementations, the Acceptable Coverage Index specifies the minimal coverage an AP it should achieve on its channel. The denser the AP deployment, the lower this value should be. The range of possible values is 1–6. Default: 4
Free Channel Index	The Dell Interference index metric measures interference for a specified channel and its surrounding channels. This value is calculated and weighted for all APs on those channels (including 3rd-party APs). An AP will only move to a new channel if the new channel has a lower interference index value than the current channel. Free Channel Index specifies the required difference between the two interference index values before the AP moves to the new channel. The lower this value, the more likely it is that the AP will move to the new channel. The range of possible values is 10–40. Default: 25 For additional information on how this the Channel Index is calculated, see "ARM Metrics" on page 361
Backoff Time	After an AP changes channel or power settings, it waits for the backoff time interval before it asks for a new channel/power setting. The range of possible values is 120–3600 seconds. Default: 240 seconds
Error Rate Threshold	The minimum percentage of PHY errors and MAC errors in the channel that will trigger a channel change. Default: 50%
Error Rate Wait Time	Minimum time in seconds the error rate has to exceed the Error Rate Threshold before it triggers a channel change. Default: 30 seconds
Noise Threshold	Maximum level of noise in channel that triggers a channel change. The supported range for this setting is 0–2,147,483,647 dBm. Default 75 dBm
Noise Wait	Minimum time in seconds the noise level has to exceed the Noise Threshold before it triggers a channel

Setting	Description
Time	change. The supported range for this setting is 15–3600 seconds. Default: 120 seconds
Minimum Scan Time	Minimum number of times a channel must be scanned before it is considered for assignment. The supported range for this setting is 0–2,147,483,647 scans. Dell recommends a Minimum Scan Time between 1–20 scans. Default: 8 scans
Load Aware Scan Threshold	Load aware ARM preserves network resources during periods of high traffic by temporarily halting ARM scanning if the load for the AP gets too high. The Load Aware Scan Threshold is the traffic throughput level an AP must reach before it stops scanning. The supported range for this setting is 0–20,000,000 bytes/second. (Specify 0 to disable this feature.) Default: 1250000 Bps
Mode Aware ARM	If enabled, ARM will turn APs into Air Monitors (AMs) if it detects higher coverage levels than necessary. This helps avoid higher levels of interference on the WLAN. Although this setting is disabled by default, you may want to enable this feature if your APs are deployed in close proximity (e.g. less than 60 feet apart). Mode aware ARM turns Air Monitors back into APs when they detect gaps in coverage. Note that an Air Monitor will not turn back into an AP if it detects client traffic (or client traffic increases), but will change to an AP only if it detects coverage holes. Default: disabled
Scan Mode	By default, 802.11n-capable APs scan channels within all regulatory domains. To limit the AP scans to just the regulatory domain for that AP, click the Scan Mode drop-down list and select reg-domain . NOTE: This setting does not apply to APs that do not support 802.11n; these APs will scan their regulatory domain only.

In the CLI

You must be in config mode to create, modify or delete an ARM profile using the CLI. Specify an existing ARM profile with the <profile-name> parameter to modify an existing ARM profile, or enter a new name to create an entirely new profile.

Configuration details and any default values for each of these parameters are described in [Table 97](#). If you do not specify a parameter for a new profile, that profile uses the default value for that parameter. Put the **no** option before any parameter to remove the current value for that parameter and return it to its default setting. Enter **exit** to leave the ARM profile mode.

Use the following command to create or modify an ARM profile:

```
(host) (config) #rf arm-profile <profile>
  40MHz-allowed-bands {All|None|a-only|g-only}
  acceptable-coverage-index <number>
  active-scan (not intended for use)
  assignment {disable|maintain|multi-band|single-band}
  backoff-time <seconds>
  client-aware
  clone <profile>
  error-rate-threshold <percent>
  error-rate-wait-time <seconds>
  free-channel-index <number>
  ideal-coverage-index <number>
  load-aware-scan-threshold <Mbps>
  max-tx-power <dBm>
  min-scan-time <# of scans>
  min-tx-power <dBm>
  mode-aware
  multi-band-scan
```

```

no
noise-threshold <number>
noise-wait-time <seconds>
ota-updates
ps-aware-scan
rogue-ap-aware
scan-interval <seconds>
scan mode all-reg-domain|reg-domain
scan-time <milliseconds>
scanning
video-aware-scan
voip-aware-scan

```

Assigning an ARM Profile to an AP Group

Once you have created a new ARM profile, you must assign it to a group of APs before those ARM settings go into effect. Each AP group has a separate set of configuration settings for its 802.11a radio profile and its 802.11g radio profile. You can assign the same ARM profile to each radio profile, or select different ARM profiles for each radio.

In the WebUI

To assign an ARM profile to an AP group via the Web User Interface:

1. Select **Configuration > AP Configuration**.
2. If it is not already selected, click the **AP Group** tab.
3. Click the **Edit** button beside the AP group to which you want to assign the new ARM profile.
4. Expand the **RF Management** section in the left window pane.
5. Select a radio profile for the new ARM profile.
 - To assign a new ARM profile to an AP group's 802.11a radio profile, expand the **802.11a radio profile** section.
 - To assign a new ARM profile to an AP group's 802.11g radio profile, expand the **802.11g radio profile** section.
6. Select **Adaptive Radio management (ARM) Profile**.
7. Click the **Adaptive Radio Management (ARM) Profile** drop-down list in the right window pane, and select a new ARM profile.
8. (Optional) repeat steps 6–8 to assign an ARM profile to another 802.11a or 802.11g radio profile.
9. Click **Apply** to save your changes.

You can also assign an ARM profile to an AP group by selecting a radio profile, identifying an AP group assigned to that radio profile, and then assigning an ARM profile to one of those groups.

1. Select **Configuration > All Profiles**.
2. Select **RF Management** and then expand either the **802.11a radio profile** or **802.11b radio profile**.
3. Select an individual radio profile name to expand that profile.
4. Click **Adaptive Radio Management (ARM) Profile**, and then use the **Adaptive Radio management (ARM) Profile** drop-down list in the right window pane to select a new ARM profile for that radio.

In the CLI

To assign an ARM profile to an AP group via the command-line interface, access the CLI in config mode and issue the following commands:

```
(host) (config) #rf dot11a-radio-profile <ap_profile>
```

```
arm-profile <arm_profile>
and
(host) (config) #rf dot11g-radio-profile <ap_profile>
arm-profile <arm_profile>
```

Where <ap_profile> is the name of the AP group, and <arm_profile> is the name of the ARM profile you want to assign to that radio band.

Using Multi-Band ARM for 802.11a/802.11g Traffic

Dell recommends using the **multi-band** ARM assignment and **Mode Aware** ARM feature for single-radio APs in networks with traffic in the 802.11a and 802.11g bands. This feature allows a single-radio AP to dynamically change its radio bands based on current coverage on the configured band. This feature is enabled via the AP's ARM profile.

When you first provision a single-radio AP, it initially operates in the radio band specified in its AP system profile. If the AP finds adequate coverage on multiple channels in its current band of operation, the **mode-aware** feature allows the AP to temporarily turn itself off and become an AP Air Monitor (APM). In AP Monitor mode, the AP scans all channels across both bands to verify that each channel meets or exceeds its required level of acceptable radio coverage (as defined by the in the ARM profile).

If the AP Monitor detects that a channel on the 802.11g band does not have adequate radio coverage, it will convert back to an AP on that 802.11 channel. If the 802.11g band is adequately covered, the AP Monitor will next check the 802.11a band. If a channel on the 802.11a band lacks coverage, the AP Monitor will convert back to an AP on that 802.11a channel.

Enabling Band Steering

ARM's band steering feature encourages dual-band capable clients to stay on the 5GHz band on dual-band APs. This frees up resources on the 2.4GHz band for single band clients like VoIP phones.

Band steering reduces co-channel interference and increases available bandwidth for dual-band clients, because there are more channels on the 5GHz band than on the 2.4GHz band. Dual-band 802.11n-capable clients may see even greater bandwidth improvements, because the band steering feature will automatically select between 40MHz or 20MHz channels in 802.11n networks. This feature is disabled by default, and must be enabled in a Virtual AP profile.

The band steering feature supports both campus APs and remote APs that have a virtual AP profile set to tunnel, split-tunnel or bridge forwarding mode. Note, however, that if a campus or remote AP has virtual AP profiles configured in bridge or split-tunnel forwarding mode *but no virtual AP in tunnel mode*, those APs will gather information about 5G-capable clients independently and will not exchange this information with other APs that also have bridge or split-tunnel virtual APs only. The band steering feature will not proactively disconnect clients that are already associated with a radio. All band steering occurs when a client is trying to associate to a new AP radio.



NOTE: Best practices is to use either the Band Steering or the Spectrum Load Balancing feature to balance client load across channels, but not both at the same time.

Steering Modes

Band steering supports the following three different band steering modes.

- **Prefer-5GHz(Default)**: If you configure the AP to use **prefer-5GHz** band steering mode, the AP will not respond to 2.4 Ghz probe requests from a client if all the following conditions are met.

- The client has already probed the AP on the 5Ghz band and therefore is known to be capable of sending probes on the 5Ghz band.
- The client is not currently associated on the 2.4Ghz radio to this AP.
- The client has sent less than 8 probes requests/auth in the last 10 seconds. If the client has sent more than 8 probes in the last 10 seconds, the client will be able to connect using whatever band it prefers
- **Force-5GHz:** When the AP is configured in **force-5GHz** band steering mode, the AP will not respond to 2.4 Ghz probe requests from a client if all the following conditions are met.
 - The client has already probed the AP on the 5Ghz band and therefore is known to be capable of sending probes on the 5Ghz band.
 - The client is not currently associated on the 2.4Ghz radio of this AP.
- **Balance-bands:** In this band steering mode, the AP tries to balance the clients across the two radios in order to best utilize the available 2.4G bandwidth. This feature takes into account the fact that the 5Ghz band has more channels than the 2.4 Ghz band, and that the 5Ghz channels operate in 40MHz while the 2.4Ghz band operates in 20MHz.

 NOTE: The band steering feature in ArubaOS versions 3.3.2.x-3.4.2.x does not support multiple bandsteering modes. The band-steering feature in these versions of ArubaOS functions the same way as the default **prefer-5GHz** steering mode available in ArubaOS 3.4.3.x and later.

Enabling Band Steering

Band steering is configured in a virtual AP profile. Use the following procedures to enable or disable Band Steering using the WebUI or command-line interfaces.

In the WebUI

1. Select **Configuration > All Profiles**. The **All Profile Management** window opens.
2. Select **Wireless LAN** to expand the **Wireless LAN** section.
3. Select **Virtual AP profile** to expand the **Virtual AP Profile** section.
4. Select the name of the Virtual AP profile for which you want to enable band steering.
(To create a new virtual AP profile, enter a name for a new profile in the **Profile Details** window, then click **Add** button. The new profile will appear in the **Profiles** list. Select that profile to open the **Profile Details** pane.)
5. In the **Profile Details** pane, select **Band Steering**. to enable this feature, or uncheck the **Band Steering** checkbox to disable this feature.
6. Once band steering is enabled, click the **steering mode** drop-down list and select the desired steering mode.
7. Click **Apply** to save your changes.

In the CLI

Use the following commands to enable band steering via the command-line interface. Access the CLI in config mode then specify an existing virtual AP with the <name> parameter to modify an existing profile, or enter a new name to create an entirely new virtual AP profile.

```
(host) (config) #wlan virtual-ap <profile> band-steering
(host) (config) #wlan virtual-ap <profile> steering-mode balance-bands|force-5ghz|prefer-5ghz
```

To disable band steering, include the **no** parameter

```
(host) (config) #wlan virtual-ap <profile> no band-steering
```

You can also use the command-line interface to configure and apply multiple instances of virtual AP profiles to an AP group or to an individual AP. Use the following commands to apply a virtual AP profile to an AP group or an individual AP.

```
(host) (config) #ap-group <name> virtual-ap <profile>
(host) (config) #ap-name <name> virtual-ap <profile>
```

Enabling Traffic Shaping

In a mixed-client network, it is possible for slower clients to bring down the performance of the whole network. To solve this problem and ensure fair access to all clients independent of their WLAN or IP stack capabilities, an AP can implement the traffic shaping feature. This feature has the following three options:

- **default-access:** Traffic shaping is disabled, and client performance is dependent on MAC contention resolution. This is the default traffic shaping setting.
- **fair-access:** Each client gets the same airtime, regardless of client capability and capacity. This option is useful in environments like a training facility or exam hall, where a mix of 802.11a/g, 802.11g and 802.11n clients need equal to network resources, regardless of their capabilities.
- **preferred-access:** High-throughput (802.11n) clients do not get penalized because of slower 802.11a/g or 802.11b transmissions that take more air time due to lower rates. Similarly, faster 802.11a/g clients get more access than 802.11b clients

With this feature, an AP keeps track of all BSSIDs active on a radio, all clients connected to the BSSID, and 802.11a/g, 802.11b, or 802.11n capabilities of each client. Every sampling period, airtime is allocated to each client, giving it opportunity to get and receive traffic. The specific amount of airtime given to an individual client is determined by the following factors:

- Client capabilities (802.11a/g, 802.11b or 802.11n).
- Amount of time the client spent receiving data during the last sampling period.
- Number of active clients in the last sampling period.
- Activity of the current client in the last sampling period.

The **bw-alloc** parameter of a traffic management profile allows you to set a minimum bandwidth to be allocated to a virtual AP profile when there is congestion on the wireless network. You must set traffic shaping to **fair-access** to use this bandwidth allocation value for an individual virtual AP.

Enabling Traffic Shaping

Traffic shaping is configured in an traffic management profile.

In the WebUI

To configure traffic shaping via the WebUI:

1. Select **Configuration > All Profiles**. The **All Profile Management** window opens.
2. Select **QoS** to expand the **QoS** section.
3. Select **Traffic management profile**.
4. In the **Profiles Details** window, select the name of the traffic management profile for which you want to configure traffic shaping. (If you do not have any traffic management profiles configured, enter a name for a new profile in the **Profile Details** pane, click **Add**, then select the new profile from the profiles list.)
5. In the **Profile Details** pane, click the **Station Shaping Policy** drop-down list and select either **default-access**, **fair-access** or **preferred-access**.
6. Click **Apply** to save your changes.

The following table describes configuration settings available in the traffic management profile.

Table 98: Traffic Management Profile Parameters

Parameter	Description
Proportional BW Allocation	<p>Minimum bandwidth, as a percentage of available bandwidth, allocated to an virtual AP (VAP) when there is congestion on the wireless network. A VAP can use all available bandwidth if no other VAPs are active.</p> <p>To assign a percentage of bandwidth to a virtual AP</p> <ol style="list-style-type: none"> 1. Click the Virtual AP drop-down list, and select the VAP to which you would like to allocate a bandwidth share. 2. Specify the percentage of bandwidth to be allocated to the VAP in the Share(%) field. 3. Click Add. 4. Repeat steps 1-3 to assign any remaining bandwidth to additional VAPs, if desired. <p>To remove a VAP from the list of VAPs with allocated bandwidth, select the VAP from the Proportional BW Allocation field and click Delete.</p>
Report Interval	<p>Number of minutes between bandwidth usage reports. The supported range is 1 through 999999 minutes, inclusive, and the default value is 5 minutes.</p>
Station Shaping Policy	<p>Define Station Shaping Policy This feature has the following three options:</p> <ul style="list-style-type: none"> • default-access: Traffic shaping is disabled, and client performance is dependent on MAC contention resolution. This is the default traffic shaping setting. • fair-access: Each client gets the same airtime, regardless of client capability and capacity. This option is useful in environments like a training facility or exam hall, where a mix of 802.11a/g, 802.11g and 802.11n clients need equal to network resources, regardless of their capabilities. The bw-alloc parameter of a traffic management profile allows you to set a minimum bandwidth to be allocated to a virtual AP profile when there is congestion on the wireless network. You must set traffic shaping to fair-access to use this bandwidth allocation value for an individual virtual AP. • preferred-access: High-throughput (802.11n) clients do not get penalized because of slower 802.11a/g or 802.11b transmissions that take more air time due to lower rates. Similarly, faster 802.11a/g clients get more access than 802.11b clients.

In the CLI

To enable and configure traffic shaping via the command-line interface, access the CLI in config mode and issue the following commands:

```
wlan traffic-management-profile <profile> shaping-policy fair-access|preferred-
```

To disable traffic shaping, use the **default-access** parameter:

```
wlan traffic-management-profile <profile> shaping-policy default-access
```

Use the following commands to apply an 802.11a or 802.11g traffic management profile to an AP group or an individual AP.

```
ap-group <name> dot11a-traffic-mgmt-profile|dot11g-traffic-mgmt-profile <profile>
ap-name <name> dot11a-traffic-mgmt-profile|dot11g-traffic-mgmt-profile <profile>
```

Enabling Spectrum Load Balancing

The spectrum load balancing feature helps optimize network resources by balancing clients across channels, regardless of whether the AP or the controller is responding to the wireless clients' probe requests. The controller uses the ARM neighbor update messages that pass between APs and the controller to determine the distribution of clients connected to each AP's immediate (one-hop) neighbors. This feature also takes into account the number of APs visible to the clients in the RF neighborhood and can factor the client's perspective on the network into its coverage calculations.

The controller compares whether or not an AP has more clients than its neighboring APs on other channels. If an AP's client load is at or over a predetermined threshold as compared to its immediate neighbors, or if a neighboring Dell AP on another channel does not have any clients, load balancing will be enabled on that AP.

When an AP has the spectrum load balancing feature enabled, the AP will send an association response with error code 17 to new clients trying to associate. If the client receiving the error code tries to associate to the AP a second time, it will be admitted. If a client is rejected by two APs in a row, it will be admitted by any AP on its third try. Note that the load balancing feature only affects the association of new clients; this feature does not reject or attempt to balance clients that are already associated to the AP.

Spectrum load balancing is disabled by default, and can be enabled for 2.4G traffic through an 802.11g profile or for 5G traffic through an 802.11a RF management profile. The spectrum load balancing feature also requires that the 802.11a or 802.11g RF management profiles reference an ARM profile with ARM scanning enabled.

 NOTE: The spectrum load balancing feature available in ArubaOS 3.4.x and later releases completely replaces the AP load balancing feature available earlier versions of ArubaOS. When you upgrade to ArubaOS 3.4.x or later, you must manually configure the spectrum load balancing settings, as the AP load balancing feature can no longer be used, and any previous AP load balancing settings will not be preserved.

For details on modifying 802.11a or 802.11g RF management profiles, refer to ["Working with Mesh High Throughput SSID Profiles"](#) on page 455 .

Reusing Channels to Control RX Sensitivity Tuning

In some dense deployments, it is possible for APs to hear other APs on the same channel. This creates co-channel interference and reduces the overall usage of the channel in a given area. Channel reuse enables dynamic control over the receive (Rx) sensitivity in order to improve spatial reuse of the channel.

 NOTE: The channel reuse feature applies to non-DFS channels only. It is internally disabled for DFS channels and is does not affect DFS radar signature detection.

You can configure the channel reuse feature to operate in either of the following three modes; *static*, *dynamic* or *disable*. (This feature is disabled by default.)

- **Static mode:** This mode of operation is a coverage-based adaptation of the Clear Channel Assessment (CCA) thresholds. In the static mode of operation, the CCA is adjusted according to the configured transmission power level on the AP, so as the AP transmit power decreases as the CCA threshold increases, and vice versa.
- **Dynamic mode:** In this mode, the Clear Channel Assessment (CCA) thresholds are based on channel loads, and take into account the location of the associated clients. When you set the Channel Reuse feature to dynamic mode, this feature is automatically enabled when the wireless medium around the AP is busy greater than half the time, and the CCA threshold adjusts to accommodate transmissions between the AP its most distant associated client.
- **Disable mode:** This mode does not support the tuning of the CCA Detect Threshold.

The channel reuse mode is configured through an 802.11a or 802.11g RF management profile. For details on modifying 802.11a or 802.11g RF management profiles, refer to “Mesh High-Throughput SSID Profiles” on page 465.

Configuring Non-802.11 for Noise Interference Immunity

When an AP attempts to decode a non-802.11 signal, that attempt can momentarily interrupt its ability to receive traffic. The noise immunity feature can help improve network performance in environments with a high level of non-

802.11 noise from devices such as Bluetooth headsets, video monitors and cordless phones.

You can configure the noise immunity feature for any one of the following levels of noise sensitivity. Note that increasing the level makes the AP slightly “deaf” to its surroundings, causing the AP to lose a small amount of range.

- Level 0: no ANI adaptation.
- Level 1: Noise immunity only. This level enables power-based packet detection by controlling the amount of power increase that makes a radio aware that it has received a packet.
- Level 2: Noise and spur immunity. This level also controls the detection of OFDM packets, and is the default setting for the Noise Immunity feature.
- Level 3: Level 2 settings and weak OFDM immunity. This level minimizes false detects on the radio due to interference, but may also reduce radio sensitivity. This level is recommended for environments with a high-level of interference related to 2.4Ghz appliances such as cordless phones.
- Level 4: Level 3 settings, and FIR immunity. At this level, the AP adjusts its sensitivity to in-band power, which can improve performance in environments with high and constant levels of noise interference.
- Level 5: The AP completely disables PHY error reporting, improving performance by eliminating the time the controller would spend on PHY processing.



NOTE: Only 802.11n-capable APs simultaneously support both the [RX Sensitivity Tuning Based Channel Reuse](#) feature and a level-3 to level-5 Noise Immunity setting. Do not raise the noise immunity default setting on APs that do not support 802.11n unless you first disable the Channel Reuse feature.

You can manage Non-802.11 Noise Immunity settings through the 802.11g RF management profile. For details refer to “[RF Management](#)” on page 433.

ARM Metrics

ARM computes coverage and interference metrics for each valid channel and chooses the best performing channel and transmit power settings for each AP’s RF environment. Each AP gathers other metrics on their ARM-assigned channel to provide a snapshot of the current RF health state.

The following two metrics help the AP decide which channel and transmit power setting is best.

- **Coverage Index:** The AP uses this metric to measure RF coverage. The coverage index is calculated as x/y , where “x” is the AP’s weighted calculation of the Signal-to-Noise Ratio (SNR) on all valid APs on a specified 802.11 channel, and “y” is the weighted calculation of the Dell AP’s SNR the neighboring APs see on that channel.

To view these values for an AP in your current WLAN environment issue the CLI command `show ap arm rf-summary ap-name <ap-name>`, where <ap-name> is the name of an AP for which you want to view information.

- **Interference Index:** The AP uses this metric to measure co-channel and adjacent channel interference. The Interference Index is calculated as $a/b/c/d$, where:

- Metric value “a” is the channel interference the AP sees on its selected channel.
- Metric value “b” is the interference the AP sees on the adjacent channel.
- Metric value “c” is the channel interference the AP’s neighbors see on the selected channel.
- Metric value “d” is the interference the AP’s neighbors see on the adjacent channel

To manually calculate the total Interference Index for a channel, issue the CLI command `show ap arm rf-summary ap-name <ap-name>`, then add the values $a+b+c+d$.

Each AP also gathers the following additional metrics, which can provide a snapshot of the current RF health state. View these values for each AP using the CLI command `show ap arm rf-summary ip-addr <ap ip address>`.

- Amount of Retry frames (measured in %)
- Amount of Low-speed frames (measured in %)

- Amount of Non-unicast frames (measured in %)
- Amount of Fragmented frames (measured in %)
- Amount of Bandwidth seen on the channel (measured in kbps)
- Amount of PHY errors seen on the channel (measured in %)
- Amount of MAC errors seen on the channel (measured in %)
- Noise floor value for the specified AP

Troubleshooting ARM

If the APs on your WLAN do not seem to be operating at an optimal channel or power setting, you should first verify that both the ARM feature and ARM scanning have been enabled. Optimal ARM performance requires that the APs have IP connectivity to their master controller, as it is the master controller that gives each AP the global classification information required to keep accurate coverage index values. If ARM is enabled but does not seem to be working properly, try some of the following troubleshooting tips.

Too many APs on the Same Channel

If many APs are selecting the same RF channel, there may be excessive interference on the other valid 802.11 channels. Issue the CLI commands `show ap arm rf-summary ap-name <ap-name>` or `show ap arm rf-summary ip-addr <ap ip address>` and calculate the Interference index (*intf_idx*) for all the valid channels.

An AP will only move to a new channel if the new channel has a lower interference index value than the current channel. The ARM Free Channel Index parameter specifies the required difference between two interference index values. If this value is set too high, the AP will not switch channels, even if the interference is slightly lower on another channel. Lower the Free Channel Index to improve the likelihood that the AP will switch to a better channel.

Wireless Clients Report a Low Signal Level

If APs detect strong signals from other APs on the same channel, they may decrease their power levels accordingly. Issue the CLI commands `show ap arm rf-summary ap-name <ap-name>` or `show ap arm rf-summary ip-addr <ap ip address>` for all APs and check their current coverage index (*cov_idx*). If the AP's coverage index is at or higher than the configured coverage index value, then the APs have correctly chosen the transmit power setting. To manually increase the minimum power level for the APs using a specific ARM profile, define a higher minimum value with the command `rf arm-profile <profile> min-tx-power <dBm>`.

If wireless clients still report that they see low signal levels for the APs, check that the AP's antennas are correctly connected to the AP and correctly placed according to the manufacturer's installation guide.

Transmission Power Levels Change Too Often

Frequent changes in transmission power levels can indicate an unstable RF environment, but can also reflect incorrect ARM or AP settings. To slow down the frequency at which the APs change their transmit power, set the ARM Backoff Time to a higher value. If APs are using external antennas, check the **Configuration > Wireless > AP Installation > Provisioning** window to make sure the APs are statically configured for the correct dBi gain, antenna type, and antenna number. If only one external antenna is connected to its radio, you must select either antenna number 1 or 2.

APs Detect Errors but Do Not Change Channels

First, ensure that ARM error checking is enabled. The ARM Error Rate Threshold should be set to a percentage higher than zero. The suggested configuration value for the ARM Error Rate Threshold is 30–50%.

APs Don't Change Channels Due to Channel Noise

APs will only change channels due to interference if ARM noise checking is enabled. Check to verify that the ARM Noise Threshold is set to a value higher than 0 dBm. The suggested setting for this threshold is 75 dBm.

Chapter 22

Wireless Intrusion Prevention

The ArubaOS Wireless Intrusion Prevention (WIP) features and configurations are discussed in this chapter. WIP offers a wide selection of intrusion detection and protection features to protect the network against wireless threats. Like most other security-related features of the Dell network, the WIP configuration is done on the master controller in the network.

To use most of the features described in this chapter, you must install a Wireless Intrusion Protection (RFprotect) license on all Dell controllers in your network. If you install a RFprotect license on a master controller only, an AP or AM terminated on a local controller will not provide the WIP features.

These features do not require an RFprotect license:

- Rogue AP classification techniques other than AP classification rules
- Rogue containment
- Wired containment
- Wireless containment without Tarpit

For details on commands see the *Dell PowerConnect W-Series ArubaOS 6.2 Command Line Interface Guide*.

This chapter contains the following sections:

- ["Working with the Reusable Wizard" on page 364](#)
- ["Monitoring the Dashboard" on page 367](#)
- ["Detecting Rogue APs" on page 368](#)
- ["Working with Intrusion Detection" on page 371](#)
- ["Configuring Intrusion Protection" on page 381](#)
- ["Configuring the WLAN Management System \(WMS\)" on page 383](#)
- ["Understanding Client Blacklisting" on page 385](#)
- ["Working with WIP Advanced Features" on page 387](#)
- ["Configuring TotalWatch" on page 388](#)
- ["Administering TotalWatch" on page 390](#)
- ["Working with Tarpit Shielding" on page 392](#)
- ["Configuring Tarpit Shielding" on page 392](#)

Working with the Reusable Wizard

The WebUI's reusable, intuitive, user-friendly Wizard provides steps to enable, define, or change:

- Integrated vs Overlay WLAN/WIP options
- Rules-based rogue classification
- Detection features for attacks against infrastructure
- Detection features for attacks against WLAN clients
- Protection features for attacks against infrastructure

- Protection features for WLAN clients

Figure 99 displays the WIP Wizard layout. Highlighting one of the previously configured rules reveals drop down menus for changing values. Note that the reusable wizard includes robust online Help.

Figure 99: WIP Wizard

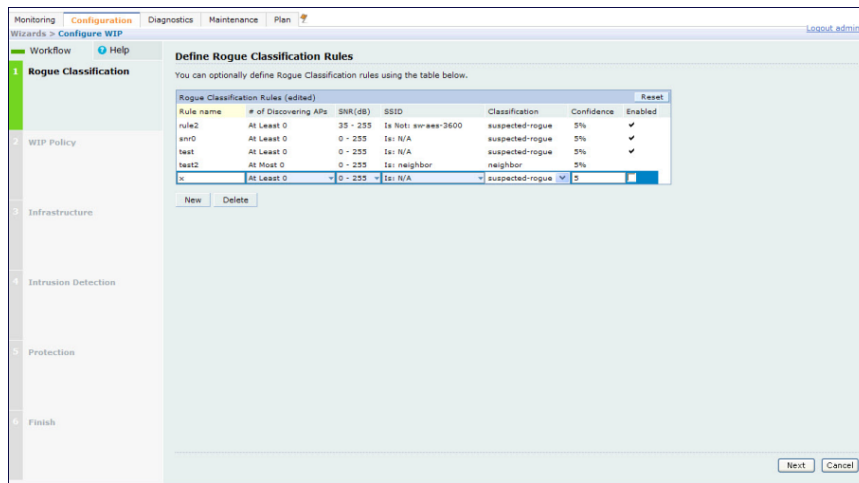

Understanding Wizard Intrusion Detection

Apply the intrusion detection mechanisms for detecting attacks against your infrastructure and clients (see Figure 100). You can either set the detection level to automatically enable the appropriate detection mechanisms or customize the settings for infrastructure and client attacks. Use the slider to select one of the detection levels for the infrastructure and clients:

- High—Enables all the detection mechanisms applicable to your infrastructure including all the options of low and medium level settings.
- Medium (Default)—Enables some important detection mechanisms for your infrastructure. This includes all the options of the low level settings.
- Low—Enables only the most critical detection mechanisms for your infrastructure.
- Off—Disables all the detection mechanisms.

To enable custom settings, click the *Allow custom settings* link to manually enable or disable the detection mechanisms for your clients. To revert to the standard settings from the custom settings mode, click the *Revert to standard settings* link.

Figure 100: WIP Wizard's Intrusion Detection

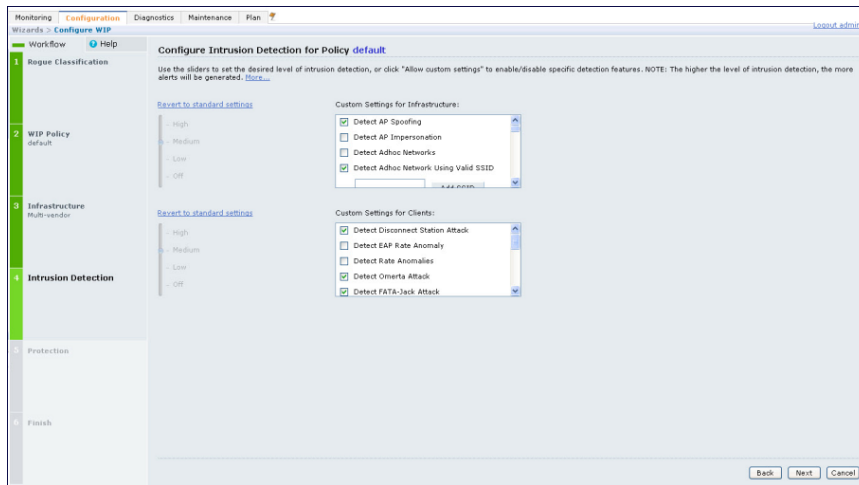

Understanding Wizard Intrusion Protection

Apply the intrusion protection mechanisms for your infrastructure and clients (see [Figure 101](#)). You can set the protection level to automatically enable the appropriate protection mechanisms or customize the settings for your infrastructure and clients.

Protecting Your Infrastructure

Use the slider to select one of the protection levels for the infrastructure:

- High—Enables all the protection mechanisms applicable to your infrastructure including all the options of low and medium level settings.
- Medium—Enables some important protection mechanisms for your infrastructure including all the options of the low level settings.
- Low—Enables only the most critical protection mechanisms for your infrastructure.
- Off (Default)—Disables all the protection mechanisms.

To enable custom settings, click the *Allow custom settings* link. You can manually enable or disable the protection mechanisms for your infrastructure. To revert to the standard settings from custom settings mode, click the *Revert to standard settings* link.

Protecting Your Clients

Use the slider (see [Figure 101](#)) to select one of the following preset protection levels for your clients:

- High—Enables all the protection mechanisms applicable to your clients including all the options of the low level settings.
- Low—Enables only the most critical protection mechanisms for your clients.
- Off (Default)—Disables all the protection mechanisms.

To enable custom settings, click the *Allow custom settings* link to manually enable or disable the protection mechanisms for your clients. To revert to the standard settings from custom settings mode, click the *Revert to standard settings* link.

Figure 101: WIP Wizard Intrusion Protection

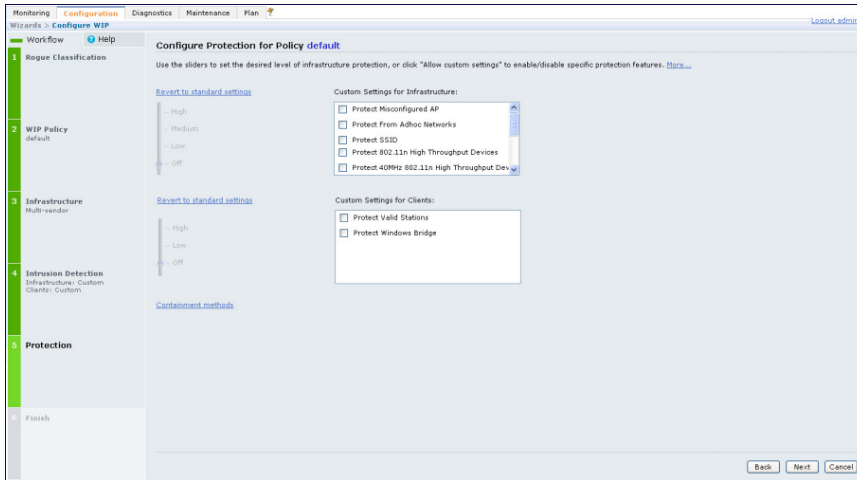

Monitoring the Dashboard

The Security Summary dashboard, in the Monitoring section of the WebUI, allows you to monitor the detection and protection of wireless intrusions in your network.

The dashboard's two top tables—Discovered APs & Clients and Events—contain data as links. When these links are selected they arrange, filter, and display the appropriate information in the lower table. For example, if you select the number 10 under the Active APs column (highlighted in yellow in Figure 102) then the bottom table will filter and arrange information about the ten classified Rogue APs. Use the scroll bar at the right to view all ten Rogue APs.



NOTE: The term *events* in this document is meant to include security threats, vulnerabilities, attacks (intrusion or Denial of Service) and other similarly related events.

The Event table contains data links. Selecting these data links will display information, in the bottom table, related to the Event you selected. Again, remember to use the scroll bar at the right to view all the Events.

Figure 102: WIP Monitoring Dashboard

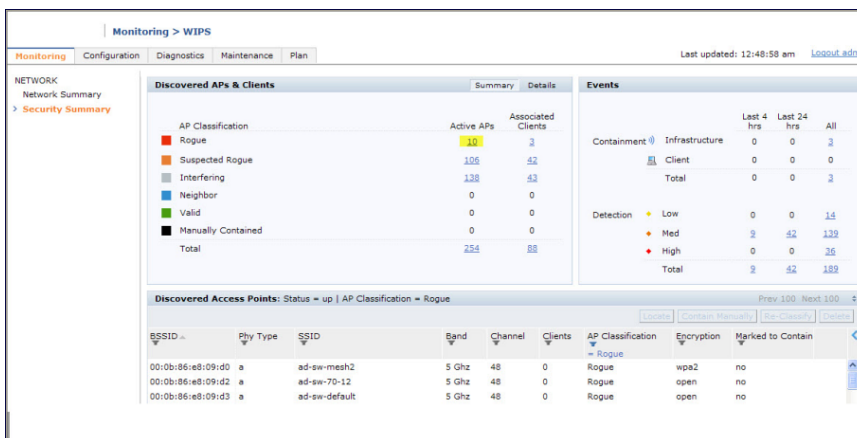

Detecting Rogue APs

The most important WIP functionality is the ability to classify an AP as a potential security threat. An AP is considered to be a rogue AP if it is both unauthorized and plugged into the wired side of the network. An AP is considered to be an interfering AP if it is seen in the RF environment but is not connected to the wired network.

While the interfering AP can potentially cause RF interference, it is not considered a direct security threat since it is not connected to the wired network. However, an interfering AP may be reclassified as a rogue AP.

Understanding Classification Terminology

APs and clients are discovered during scanning of the wireless medium, and they are classified into various groups. The AP and client classification definitions are in [Table 103](#) and [Table 104](#).

Table 103: *AP Classification Definition*

Classification	Description
Valid AP	An AP that is part of the enterprise providing WLAN service.
Interfering AP	An AP that is seen in the RF environment but is not connected to the wired network. An interfering AP is not considered a direct security threat since it is not connected to the wired network. For example, an interfering AP can be an AP that belongs to a neighboring office's WLAN but is not part of your WLAN network.
Neighbor AP	A neighboring AP is when the BSSIDs are known. Once classified, a neighboring AP does not change its state.
Rogue AP	An unauthorized AP that is plugged into the wired side of the network.
Suspected-Rogue AP	A suspected rogue AP is an unauthorized AP that may be plugged into the wired side of the network.
Manually-contained AP	An AP for which DoS is enabled manually.

Table 104: *Client Classification Definitions*

Classification	Description
Valid Client	Any client that successfully authenticates with a valid AP and passes encrypted traffic is classified as a valid client.
Manually-contained Client	Any clients for which DoS is enabled manually.
Interfering Client	A client associated to any AP and is not valid.

Understanding Classification Methodology

A discovered AP is classified as a rogue or a suspected rogue by the following methods:

- Internal heuristics
- AP classification rules
- Manually by the user

The internal heuristics works by checking if the discovered AP is communicating with a wired device on the customer network. This is done by matching the MAC address of devices that are on the discovered AP's network

with that of the user's wired network. The MAC of the device on the discovered AP's network is known as the *Match MAC*. The ways in which the matching of wired MACs occurs is detailed in the sections "[Understanding Match Methods](#)" on page 369 and "[Understanding Match Types](#)" on page 369.

Understanding Match Methods

The match methods are:

- Plus One—The match MAC matches a device whose MAC address' last bit was one more than that of the Match MAC.
- Minus One—The match MAC matches a device whose MAC address' last bit was one less than that of the Match MAC.
- Equal—The match was against the same MAC address.
- OUI—The match was against the manufacturer's OUI of the wired device.

The classification details are available in the 'Discovered AP table' section of the 'Security Summary' page of the WebUI. The information can be obtained by clicking on the details icon for a selected discovered AP. The information is also available in the command `show wms rogue-ap`.

Understanding Match Types

- Eth-Wired-MAC—The MAC addresses of wired devices learned by an AP on its Ethernet interface.
- GW-Wired-MAC—The collection of Gateway MACs of all APs across the master and local Dell controllers.
- AP-Wired-MAC—The MAC addresses of wired devices learned by monitoring traffic out of other valid and rogue APs.
- Config-Wired-MAC—The MAC addresses that are configured by the user typically that of well known servers in the network.
- Manual—User triggered classification.
- External-Wired-MAC—The MAC address matched a set of known wired devices that are maintained in an external database.
- Mobility-Manager—The classification was determined by the mobility manager, AMP.
- Classification-off—AP is classified as rogue because classification has been disabled causing all non-authorized APs to be classified as a rogue.
- Propagated-Wired-MAC—The MAC addresses of wired devices learned by a different AP than the one that uses it for classifying a rogue.
- Base-BSSID-Override—The classification was derived from another BSSID which belongs to the same AP that supports multiple BSSIDs on the radio interface.
- AP-Rule—A user defined AP classification rule has matched.
- System-Wired-MAC—The MAC addresses of wired devices learned at the controller.
- System-Gateway-MAC—The Gateway MAC addresses learned at the controller.

Understanding Suspected Rogue Confidence Level

A suspected rogue AP is an AP that is potentially a threat to the WLAN infrastructure. A suspected rogue AP has a confidence level associated with it. An AP can be marked as a suspected rogue if it is determined to be a potentially threat on the wired network, or if it matches a user defined classification rule.

The suspected-rogue classification mechanism are:

- Each mechanism that causes a suspected-rogue classification is assigned a confidence level increment of 20%.
- AP classification rules have a configured confidence level.

- When a mechanism matches a previously unmatched mechanism, the confidence level increment associated with that mechanism is added to the current confidence level (the confident level starts at zero).
- The confidence level is capped at 100%.
- If your controller reboots, your suspected-rogue APs are not checked against any new rules that were configured after the reboot. Without this restriction, all the mechanisms that classified your APs as suspected-rogue may trigger again causing the confidence level to surpass their cap of 100%. You can explicitly mark an AP as “interfering” to trigger all new rules to match against it.

Understanding AP Classification Rules

AP classification rule configuration is performed only on a master controller. If AMP is enabled via the mobility-manager command, then processing of the AP classification rules is disabled on the master controller. A rule is identified by its ASCII character string name (32 characters maximum). The AP classification rules have one of the following specifications:

- SSID of the AP
- SNR of the AP
- Discovered-AP-Count or the number of APs that can see the AP

Understanding SSID specification

Each rule can have up to 6 SSID parameters. If one or more SSIDs are specified in a rule, an option of whether to match any of the SSIDs, or to not match all of the SSIDs can be specified. The default is to check for a match operation.

Understanding SNR specification

Each rule can have only one specification of the SNR. A minimum and/or maximum can be specified in each rule and the specification is in SNR (db).

Understanding Discovered-AP-Count specification

Each rule can have only one specification of the Discovered-AP-Count. Each rule can specify a minimum or maximum of the Discovered-AP-count. The minimum or maximum operation must be specified if the Discovered-AP-count is specified. The default setting is to check for the minimum discovered-AP-count.

Sample Rules

If SSID equals xyz AND SNR > 40 then classify AP as suspected-rogue with conf-level-increment of 20

If SNR > 60 and DISCOVERING_APS > 2, then classify AP as suspected-rogue with conf-level increment of 35

If SSID equals ‘XYZ’, then classify AP as known-neighbor

Understanding Rule Matching

A rule must be enabled before it is matched. A maximum of 32 rules can be created with a maximum of 16 rules active simultaneously. If a rule matches, an AP is classified to:

- Suspected-Rogue—an associated confidence-level is provided (minimum is 5%)
- Neighbor

The following mechanism is used for rule matching.

- When *all* the conditions specified in the rule evaluate to true, the rule matches.
- If multiple rules match causing the AP to be classified as a Suspected-Rogue, the confidence level of each rule is aggregated to determine the confidence level of the classification.

- When multiple rules match and any one of those matching rules cause the AP to be classified as a Neighbor, then the AP is classified as Neighbor.
- APs classified as either Neighbor or Suspected-Rogue will attempted to match any configured AP rule.
- Once a rule matches an AP, the same rule will not be checked for the AP.
- When the controller reboots, no attempt to match a previously matched AP is made.
- If a rule is disabled or modified, all APs that were previously classified based on that rule will continue to be in the newly classified state.

Working with Intrusion Detection

This section covers Infrastructure and Client Intrusion Detections.

Understanding Infrastructure Intrusion Detection

Detecting attacks against the infrastructure is critical in avoiding attacks that may lead to a large-scale Denial of Service (DOS) attack or a security breach. This group of features detects attacks against the WLAN infrastructure, which consists of authorized APs, the RF medium, and the wired network. An authorized or valid-AP is defined as an AP that belongs to the WLAN infrastructure. The AP is either a Dell AP or a third party AP. ArubaOS automatically learns authorized Dell APs.

Table 105 presents a summary of the Intrusion infrastructure detection features with their related commands, traps, and syslog identification. Feature details follow the table.

Table 105: Infrastructure Detection Summary

Feature	Command	Trap	Syslog ID
"Detecting an 802.11n 40MHz Intolerance Setting" on page 374	ids dos-profile detect-ht-40mhz-intolerance client-ht-40mhz-intol-quiet-time	wlsxHT40MHzIntoleranceAP wlsxHT40MHzIntoleranceSta	126052, 126053, 127052, 127053
"Detecting Active 802.11n Greenfield Mode" on page 374	ids unauthorized-device-profile detect-ht-greenfield	wlsxHtGreenfieldSupported	126054, 127054
"Detecting Ad hoc Networks" on page 374	ids unauthorized-device-profile detect-adhoc-network	wlsxNAdhocNetwork	126033, 127033
"Detecting an Ad hoc Network Using a Valid SSID" on page 374	ids unauthorized-device-profile detect-adhoc-using-valid-ssid adhoc-using-valid-ssid-quiet-time	wlsxAdhocUsingValidSSID	126068, 127068
"Detecting an AP Flood Attack" on page 374	ids dos-profile detect-ap-flood ap-flood-threshold ap-flood-inc-time ap-flood-quiet-time	wlsxApFloodAttack	126034, 127034
"Detecting AP Impersonation" on page 374	ids impersonation-profile detect-ap-impersonation beacon-diff-threshold beacon-inc-wait-time	wlsxAPImpersonation	126006, 127006

Feature	Command	Trap	Syslog ID
"Detecting AP Spoofing" on page 374	ids impersonation-profile detect-ap-spoofing ap-spoofing-quiet-time	wlsxAPSpoofingDetected wlsxClientAssociatingOn WrongChannel	126069, 126070, 127069, 127070
"Detecting Bad WEP Initialization" on page 375	ids unauthorized-device-profile detect-bad-wep	wlsxRepeatWEPIVViolation wlsxStaRepeatWEPIVViolation wlsxWeakWEPIVViolation wlsxStaWeakWEPIVViolation	126014, 126015, 126016, 126017, 127014, 127015, 127016, 127017
"Detecting a Beacon Frame Spoofing Attack" on page 375	ids impersonation-profile detect-beacon-wrong-channel beacon-wrong-channel-quiet-time	wlsxMalformedFrameWrongChannel Detected	126086, 127086
"Detecting a Client Flood Attack" on page 375	ids dos-profile detect-client-flood client-flood-threshold client-flood-inc-time client-flood-quiet-time	wlsxClientFloodAttack	126064, 127064
"Working with Intrusion Detection" on page 371	ids dos-profile detect-cts-rate-anomaly cts-rate-threshold cts-rate-time-interval cts-rate-quiet-time	wlsxCtsRateAnomaly	126073, 127073
"Detecting Devices with an Invalid MAC OUI" on page 375	ids unauthorized-device-profile detect-invalid-mac-oui mac-oui-quiet-time	wlsxInvalidMacOUIAP wlsxInvalidMacOUISta	126029, 126030, 127029, 127030
"Detecting an Invalid Address Combination" on page 375	ids dos-profile detect-invalid-address-combination invalid-address-combination-quiet-time	wlsxInvalidAddressCombination	126079, 127079
"Detecting an Overflow EAPOL Key" on page 375	ids dos-profile detect-overflow-eapol-key overflow-eapol-key-quiet-time	wlsxMalformedOverflowEAPOLKey Detected	126082, 127082
"Detecting Overflow IE Tags" on page 375	ids dos-profile detect-overflow-ie overflow-ie-quiet-time	wlsxOverflowIEDetected	126084, 127084
"Detecting a Malformed Frame- Assoc Request" on page 375	ids dos-profile detect-malformed-assoc-req malformed-assoc-req-quiet-time	wlsxMalformedAssocReqDetected	126080, 127080
"Detecting Malformed Frame-Auth" on page 376	ids dos-profile detect-malformed-frame-auth malformed-auth-frame-quiet-time	wlsxMalformedAuthFrameDetected	126083, 127083
"Detecting a Malformed Frame-HT IE" on page 376	ids dos-profile detect-malformed-htie malformed-htie-quiet-time	wlsxMalformedHTIEDetected	126081, 127081
"Detecting a	ids-dos-profile	wlsxMalformedFrameLargeDuration	126085, 127085

Feature	Command	Trap	Syslog ID
Malformed Frame- Large Duration" on page 376	detect-malformed-large-duration malformed-large-duration-quiet-time	Detected	
"Detecting a Misconfigured AP" on page 376 (WEP, WPA, SSID, Channel, OUI)	ids unauthorized-device-profile detect-misconfigured-ap privacy require-wpa valid-and-protected-ssid cfg-valid-11g-channel cfg-valid-11a-channel valid-oui	wlsxWEPMisconfiguration wlsxWPAMisconfiguration wlsxSSIDMisconfiguration wlsxChannelMisconfiguration wlsxOUIMisconfiguration	126011, 126028, 126010, 126008, 126009, 127011, 127028, 127010, 127008, 127009
"Detecting an RTS Rate Anomaly" on page 375	ids dos-profile detect-rts-rate-anomaly rts-rate-threshold rts-rate-time-interval rts-rate-quiet-time	wlsxRtsRateAnomaly	126074, 127074
"Detecting a Windows Bridge" on page 376	ids unauthorized-device-profile detect-windows-bridge	wlsxWindowsBridgeDetectedAP wlsxWindowsBridgeDetectedSta wlsxNAdhocNetworkBridgeDetectedAP wlsxNAdhocNetworkBridgeDetectedSta	126039, 126040, 126041, 126042, 127039, 127040, 127041, 127042
"Detecting a Wireless Bridge" on page 376	ids unauthorized-device-profile detect-wireless-bridge wireless-bridge-quiet-time	wlsxWirelessBridge	126036, 127036
"Detecting Broadcast Deauthentication" on page 376	ids signature-matching-profile signature deauth-Broadcast ids general-profile signature-quiet-time	wlsxNSignatureMatchDeauthBcast	126047, 127047
"Detecting Broadcast Disassociation" on page 376	ids signature-matching-profile signature disassoc-Broadcast ids general-profile signature-quiet-time	wlsxNSignatureMatchDisassocBcast	126066, 127066
"Detecting Netstumbler" on page 376	ids signature-matching-profile signature 'Netstumbler Generic' signature 'Netstumbler Version 3.3.0.x' ids general-profile signature-quiet-time	wlsxNSignatureMatchNetstumbler	126043, 127043
"Detecting Valid SSID Misuse" on page 376	ids-unauthorized-device-profile detect-valid-ssid-misuse valid-and-protected-ssid	wlsxValidSSIDViolation	126007, 127007
"Detecting Wellenreiter" on page	ids signature-matching-profile signature Wellenreiter	wlsxNSignatureMatchWellenreiter	126067, 127067

Feature	Command	Trap	Syslog ID
377	ids general-profile signature-quiet-time		

Detecting an 802.11n 40MHz Intolerance Setting

When a client sets the HT capability “intolerant bit” to indicate that it is unable to participate in a 40MHz BSS, the AP must use lower data rates with all of its clients. Network administrators often want to know if there are devices that are advertising 40MHz intolerance, as this can impact the performance of the network.

Detecting Active 802.11n Greenfield Mode

When 802.11 devices use the HT operating mode, they can not share the same channel as 802.11a/b/g stations. Not only can they not communicate with legacy devices, the way they use the transmission medium is different, which would cause collisions, errors and retransmissions.

Detecting Ad hoc Networks

An ad hoc network is a collection of wireless clients that form a network amongst themselves without the use of an AP. As far as network administrators are concerned, ad hoc wireless networks are uncontrolled. If they do not use encryption, they may expose sensitive data to outside eavesdroppers. If a device is connected to a wired network and has bridging enabled, an ad-hoc network may also function like a rogue AP. Additionally, ad-hoc networks can expose client devices to viruses and other security vulnerabilities. For these reasons, many administrators choose to prohibit ad-hoc networks.

Detecting an Ad hoc Network Using a Valid SSID

If an unauthorized ad hoc network is using the same SSID as an authorized network, a valid client may be tricked into connecting to the wrong network. If a client connects to a malicious ad hoc network, security breaches or attacks can occur.

Detecting an AP Flood Attack

Fake AP is a tool that was originally created to thwart wardrivers by flooding beacon frames containing hundreds of different addresses. This would appear to a wardriver as though there were hundreds of APs in the area, thus concealing the real AP. An attacker can use this tool to flood an enterprise or public hotspots with fake AP beacons to confuse legitimate users and to increase the amount of processing need on client operating systems.

Detecting AP Impersonation

In AP impersonation attacks, the attacker sets up an AP that assumes the BSSID and ESSID of a valid AP. AP impersonation attacks can be done for man-in-the-middle attacks, a rogue AP attempting to bypass detection, or a honeypot attack.

Detecting AP Spoofing

An AP Spoofing attack involves an intruder sending forged frames that are made to look like they are from a legitimate AP. It is trivial for an attacker to do this, since tools are readily available to inject wireless frames with any MAC address that the user desires. Spoofing frames from a legitimate AP is the foundation of many wireless attacks.

Detecting Bad WEP Initialization

This is the detection of WEP initialization vectors that are known to be weak. A primary means of cracking WEP keys is to capture 802.11 frames over an extended period of time and searching for such weak implementations that are still used by many legacy devices.

Detecting a Beacon Frame Spoofing Attack

In this type of attack, an intruder spoofs a beacon packet on a channel that is different from that advertised in the beacon frame of the AP.

Detecting a Client Flood Attack

There are fake AP tools that can be used to attack wireless intrusion detection itself by generating a large number of fake clients that fill internal tables with fake information. If successful, it overwhelms the wireless intrusion system, resulting in a DoS.

Detecting an RTS Rate Anomaly

The RF medium can be reserved via Virtual Carrier Sensing using an CTS/RTS transaction. The transmitter station sends a Request To Send (RTS) frame to the receiver station. The receiver station responds with a Clear To Send (CTS) frame. All other stations that receive these RTS and/or CTS frames will refrain from transmitting over the wireless medium for an amount of time specified in the *duration* fields of these frames.

Attackers can exploit the Virtual Carrier Sensing mechanism to launch a DoS attack on the WLAN by transmitting numerous RTS and/or CTS frames. This causes other stations in the WLAN to defer transmission to the wireless medium. The attacker can essentially block the authorized stations in the WLAN with this attack.

Detecting Devices with an Invalid MAC OUI

The first three bytes of a MAC address, known as the MAC organizationally unique identifier (OUI), is assigned by the IEEE to known manufacturers. Often clients using a spoofed MAC address do not use a valid OUI and instead use a randomly generated MAC address.

Detecting an Invalid Address Combination

In this attack, an intruder can cause an AP to transmit deauthentication and disassociation frames to all of its clients. Triggers that can cause this condition include the use of broadcast or multicast MAC address in the source address field.

Detecting an Overflow EAPOL Key

Some wireless drivers used in access points do not correctly validate the EAPOL key fields. A malicious EAPOL-Key packet with an invalid advertised length can trigger a DoS or possible code execution. This can only be achieved after a successful 802.11 association exchange.

Detecting Overflow IE Tags

Some wireless drivers used in access points do not correctly parse the vendor-specific IE tags. A malicious association request sent to the AP containing an IE with an inappropriate length (too long) can cause a DoS and potentially lead to code execution. The association request must be sent after a successful 802.11 authentication exchange.

Detecting a Malformed Frame-Assoc Request

Some wireless drivers used in access points do not correctly parse the SSID information element tag contained in association request frames. A malicious association request with a null SSID (that is, zero length SSID) can trigger a DoS or potential code execution condition on the targeted device.

Detecting Malformed Frame-Auth

Malformed 802.11 authentication frames that do not conform to the specification can expose vulnerabilities in some drivers that have not implemented proper error checking. This feature checks for unexpected values in a Authentication frame.

Detecting a Malformed Frame-HT IE

The IEEE 802.11n HT (High Throughput) IE is used to convey information about the 802.11n network. A 802.11 management frame containing a malformed HT IE can crash some client implementations; potentially representing an exploitable condition when transmitted by a malicious attacker.

Detecting a Malformed Frame-Large Duration

The virtual carrier-sense attack is implemented by modifying the 802.11 MAC layer implementation to allow random duration values to be sent periodically. This attack can be carried out on the ACK, data, RTS, and CTS frame types by using large duration values. This attack can prevent channel access to legitimate users.

Detecting a Misconfigured AP

A list of parameters can be configured that defines the characteristics of a valid AP. This feature is primarily used when non-Dell APs are used in the network since the Dell controller cannot configure the third-party APs. These parameters include WEP, WPA, OUI of valid MAC addresses, valid channels, and valid SSIDs.

Detecting a Windows Bridge

A Windows Bridge occurs when a client that is associated to an AP is also connected to the wired network, and has enabled bridging between these two interfaces.

Detecting a Wireless Bridge

Wireless bridges are normally used to connect multiple buildings together. However, an attacker could place (or have an authorized person place) a wireless bridge inside the network that would extend the corporate network somewhere outside the building. Wireless bridges are somewhat different from rogue APs in that they do not use beacons and have no concept of association. Most networks do not use bridges – in these networks, the presence of a bridge is a signal that a security problem exists.

Detecting Broadcast Deauthentication

A deauthentication broadcast attempts to disconnect all stations in range. Rather than sending a spoofed deauth to a specific MAC address, this attack sends the frame to a broadcast address.

Detecting Broadcast Disassociation

By sending disassociation frames to the broadcast address (FF:FF:FF:FF:FF:FF), an attacker can disconnect all stations on a network for a widespread DoS.

Detecting Netstumbler

NetStumbler is a popular wardriving application used to locate 802.11 networks. When used with certain NICs, NetStumbler generates a characteristic frame that can be detected. Version 3.3.0 of NetStumbler changed the characteristic frame slightly.

Detecting Valid SSID Misuse

If an unauthorized AP (neighbor or interfering) is using the same SSID as an authorized network, a valid client may be tricked into connecting to the wrong network. If a client connects to a malicious network, security breaches or attacks can occur.

Detecting Wellenreiter

Wellenreiter is a passive wireless network discovery tool that is used to compile a list of APs along with their MAC address, SSID, channel, security setting in the vicinity. It passively sniffs wireless traffic and with certain version (versions 1.4, 1.5, and 1.6) sends active probes that target known default SSIDs.

Understanding Client Intrusion Detection

Generally, clients are more vulnerable to attacks than APs. Clients are more apt to associate with a malignant AP due to the client's driver behavior or to a misconfigured client. It is important to monitor authorized clients to track their associations and to track any attacks raised against the client. Client attack detection is categorized as:

- Detecting attacks against Dell APs clients—An attacker can perform an active DOS attack against an associated client, or perform a replay attack to obtain the keys of transmission which could lead to more serious attacks.
- Monitoring Authorized clients—Since clients are easily tricked into associating with unauthorized APs, tracking all misassociations of authorized clients is very important.

An authorized client is a client authorized to use the WLAN network. In ArubaOS, an authorized client is called a *valid-client*. ArubaOS automatically learns a valid client. A client is determined to be valid if it is associated to an authorized or valid AP using encryption; either Layer 2 or IPSEC.

NOTE: Detection of attacks is limited to valid clients and clients associated to valid APs. Clients that are associated as guests using unencrypted association are included in the attack detection. However, clients on neighboring (interfering) APs are not tracked for attack detection unless they are specified as valid.

Table 106 presents a summary of the client intrusion detection features with their related commands, traps, and syslog identification. Details of each feature follow the table.

Table 106: *Client Detection Summary*

Feature	Command	Trap	Syslog ID
"Detecting a Block ACK DoS" on page 379	ids-dos-profile detect-block-ack-attack block-ack-quiet-time	wlsxBlockAckAttackDetected	126087, 127087
"Detecting a ChopChop Attack" on page 379	ids-dos-profile detect-chopchop-attack chopchop-quiet-time	wlsXChopChopAttackDetected	126078, 127078
"Detecting a Disconnect Station Attack" on page 379	ids dos-profile <name> detect-disconnect-sta disconnect-sta-quiet-time disconnect-sta-assoc-resp-threshold disconnect-deauth-disassoc-threshold	wlsXNDisconnectStationAttack	126035, 127035
"Detecting an EAP Rate Anomaly" on page 379	ids-dos-profile detect-eap-rate-anomaly eap-rate-threshold eap-rate-time-interval eap-rate-quiet-time	wlsXEAPRateAnomaly	126032, 127032
"Detecting a FATA-Jack Attack Structure" on page 379	ids dos-profile detect-fatajack-attack fatajack-attack-quiet-time	wlsXFataJackAttackDetected	126072, 127072

Feature	Command	Trap	Syslog ID
"Detecting a Hotspotter Attack" on page 379	ids impersonation-profile detect-hotspotter-attack hotspotter-quiet-time	wlsxHotspotterAttackDetected	126088, 127088
"Detecting a Meiners Power Save DoS Attack" on page 379	ids dos-profile detect-power-save-dos-attack power-save-dos-min-frames power-save-dos-quiet-time power-save-dos-threshold	wlsxPowerSaveDoSAttack	126109, 127109
"Detecting an Omerta Attack" on page 380	ids dos-profile detect-omerta-attack omerta-attack-threshold omerta-attack-quiet-time	wlsxOmertaAttack	126071, 127071
"Detecting Rate Anomalies" on page 380	ids dos-profile detect-rate-anomalies assoc-rate-thresholds disassoc-rate-thresholds deauth-rate-thresholds probe-request-rate-thresholds probe-response-rate-thresholds auth-rate-thresholds	wlsxChannelRateAnomaly wlsxNodeRateAnomalyAP wlsxNodeRateAnomalySta	126061, 126062, 126063, 127061, 127062, 127063
"Detecting a TKIP Replay Attack" on page 380	ids dos-profile detect-kip-replay-attack kip-replay-quiet-time	wlsxTkipReplayAttackDetected	126077, 127077
"Detecting Unencrypted Valid Clients" on page 380	ids unauthorized-device-profile detect-unencrypted-valid-client unencrypted-valid-client-quiet-time	wlsxValidClientNotUsingEncryption	126065, 127065
"Detecting a Valid Client Misassociation" on page 380	ids unauthorized-device-profile detect-valid-client-misassociation	wlsxValidClientMisassociation	126075, 127075
"Detecting an AirJack Attack" on page 380	ids signature-matching-profile signature AirJack ids general-profile signature-quiet-time	wlsxNSignatureMatchAirjack	126046, 127046
"Detecting ASLEAP" on page 380	ids signature-matching-profile signature ASLEAP ids general-profile signature-quiet-time	wlsxNSignatureMatchAsleap	126044, 127044
"Detecting a Null Probe Response" on page 380	ids signature-matching-profile signature Null Probe Response ids general-profile signature-quiet-time	wlsxNSig- natureMatchNullProbeResp	126045, 127045

Detecting a Block ACK DoS

The Block ACK mechanism that was introduced in 802.11e, and enhanced in 802.11nD3.0, has a built-in DoS vulnerability. The Block ACK mechanism allows for a sender to use the ADDBA request frame to specify the sequence number window that the receiver should expect. The receiver will only accept frames in this window.

An attacker can spoof the ADDBA request frame causing the receiver to reset its sequence number window and thereby drop frames that do not fall in that range.

Detecting a ChopChop Attack

ChopChop is a plaintext recovery attack against WEP encrypted networks. It works by forcing the plaintext, one byte at a time, by truncating a captured frame and then trying all 256 possible values for the last byte with a corrected CRC. The correct guess causes the AP to retransmit the frame. When that happens, the frame is truncated again.

Detecting a Disconnect Station Attack

A disconnect attack can be launched in many ways; the end result is that the client is effectively and repeatedly disconnected from the AP.

Detecting an EAP Rate Anomaly

To authenticate wireless clients, WLANs may use 802.1x, which is based on a framework called Extensible Authentication Protocol (EAP). After an EAP packet exchange and the user is successfully authenticated, the EAP-Success is sent from the AP to the client. If the user fails to authenticate, an EAP-Failure is sent. In this attack, EAP-Failure or EAP-Success frames are spoofed from the access point to the client to disrupting the authentication state on the client. This confuses the client's state causing it to drop the AP connection. By continuously sending EAP Success or Failure messages, an attacker can effectively prevent the client from authenticating with the APs in the WLAN.

Detecting a FATA-Jack Attack Structure

FATA-Jack is an 802.11 client DoS tool that tries to disconnect targeted stations using spoofed authentication frames that contain an invalid authentication algorithm number.

Detecting a Hotspotter Attack

The Hotspotter attack is an evil-twin attack which attempts to lure a client to a malicious AP. Many enterprise employees use their laptop in Wi-Fi area hotspots at airports, cafes, malls etc. They have SSIDs of their hotspot service providers configured on their laptops. The SSIDs used by different hotspot service providers are well known. This enables the attackers to set up APs with hotspot SSIDs in close proximity of the enterprise premises. When the enterprise laptop Client probes for hotspot SSID, these malicious APs respond and invite the client to connect to them. When the client connects to a malicious AP, a number of security attacks can be launched on the client. A popular hacking tool used to launch these attacks is Aircsnarf.

Detecting a Meiners Power Save DoS Attack

To save on power, wireless clients will "sleep" periodically, during which they cannot transmit or receive. A client indicates its intention to sleep by sending frames to the AP with the Power Management bit ON. The AP then begins buffering traffic bound for that client until it indicates that it is awake. An intruder could exploit this mechanism by sending (spoofed) frames to the AP on behalf of the client to trick the AP into believing the client is asleep. This will cause the AP to buffer most, if not all, frames destined for the client.

Detecting an Omerta Attack

Omerta is an 802.11 DoS tool that sends disassociation frames to all stations on a channel in response to data frames. The Omerta attack is characterized by disassociation frames with a reason code of 0x01. This reason code is “unspecified” and is not be used under normal circumstances.

Detecting Rate Anomalies

Many DoS attacks flood an AP or multiple APs with 802.11 management frames. These can include authenticate/associate frames which are designed to fill up the association table of an AP. Other management frame floods, such as probe request floods, can consume excess processing power on the AP.

Detecting a TKIP Replay Attack

TKIP is vulnerable to replay (via WMM/QoS) and plaintext discovery (via ChopChop). This affects all WPA-TKIP usage. By replaying a captured TKIP data frame on other QoS queues, an attacker can manipulate the RC4 data and checksum to derive the plaintext at a rate of one byte per minute.

By targeting an ARP frame and guessing the known payload, an attacker can extract the complete plaintext and MIC checksum. With the extracted MIC checksum, an attacker can reverse the MIC AP to Station key and sign future messages as MIC compliant, opening the door for more advanced attacks.

Detecting Unencrypted Valid Clients

An authorized (valid) client that is passing traffic in unencrypted mode is a security risk. An intruder can sniff unencrypted traffic (also known as *packet capture*) with software tools known as sniffers. These packets are then reassembled to produce the original message.

Detecting a Valid Client Misassociation

This feature does not detect attacks, but rather it monitors authorized (valid) wireless clients and their association within the network. Valid client misassociation is potentially dangerous to network security. The four types of misassociation that we monitor are:

- Authorized Client associated to Rogue—A valid client that is associated to a rogue AP
- Authorized Client associated to External AP—An external AP, in this context, is any AP that is not valid and not a rogue
- Authorized Client associated to Honeypot AP—A honeypot is an AP that is not *valid* but is using an SSID that has been designated as valid/protected
- Authorized Client in ad hoc connection mode—A valid client that has joined an ad hoc network

Detecting an AirJack Attack

AirJack is a suite of device drivers for 802.11 (a/b/g) raw frame injection and reception. It was intended to be used as a development tool for all 802.11 applications that need to access the raw protocol, however one of the tools included allowed users to force off all users on an AP.

Detecting ASLEAP

ASLEAP is a tool created for Linux systems which is used to attack Cisco LEAP authentication protocol.

Detecting a Null Probe Response

A null probe response attack has the potential to crash or lock up the firmware of many 802.11 NICs. In this attack, a client probe-request frame will be answered by a probe response containing a null SSID. A number of popular NIC cards will lock up upon receiving such a probe response.

Configuring Intrusion Protection

Intrusion protection features support containment of an AP or a client. In the case of an AP, we will attempt to disconnect all client that are connected or attempting to connect to the AP. In the case of a client, the client's association to an AP is targeted. The following containment mechanisms are supported:

- Deauthentication containment: An AP or client is contained by disrupting its association on the wireless interface.
- Tarpit containment: An AP is contained by luring clients that are attempting to associate with it to a tarpit. The tarpit can be on the same channel as the AP being contained, or on a different channel (see ["Working with Tarpit Shielding" on page 392](#)).
- Wired containment: An AP or client is contained by disrupting its connection on the wired interface.

The WIP feature supports separate enforcement policies that use the underlying containment mechanisms to contain an AP or a client that do not conform to the policy. These policies are discussed in the sections that follow.

Understanding Infrastructure Intrusion Protection

Table 107 presents a summary of the infrastructure intrusion protection features with their related commands, traps, and syslog identifications. Details of each feature follow the table.

Table 107: Infrastructure Protection Summary

Feature	Command	Trap	Syslog ID
"Protecting 40MHz 802.11 High Throughput Devices" on page 382	ids unauthorized-device-profile protect-ht-40mhz	wlsxAPDeauthContainment wlsxCliEntDeauthContainment wlsxTarpitContainment	106005, 106006, 126102, 126103, 126108, 127102, 127103, 127108
"Protecting 802.11n High Throughput Devices" on page 382	ids unauthorized-device-profile protect-high-throughput	wlsxAPDeauthContainment wlsxCliEntDeauthContainment wlsxTarpitContainment	106005, 106006, 126102, 126103, 126108, 127102, 127103, 127108
"Protecting Against Adhoc Networks" on page 382	ids unauthorized-device-profile protect-adhoc-network	wlsxAPDeauthContainment wlsxCliEntDeauthContainment wlsxTarpitContainment	106005, 106006, 126012, 126102, 126103, 126108, 127102, 127103, 127108
"Protecting Against AP Impersonation " on page 382	ids impersonation-profile protect-ap-impersonation	wlsxAPDeauthContainment wlsxCliEntDeauthContainment wlsxTarpitContainment	106005, 106006, 126102, 126103, 126108, 127102, 127103, 127108
"Protecting Against Misconfigured APs" on page 382	ids unauthorized-device-profile protect-misconfigured-ap	wlsxAPDeauthContainment wlsxCliEntDeauthContainment wlsxTarpitContainment	106005, 106006, 126102, 126103, 126108, 127102, 127103, 127108
"Protecting SSIDs" on page 382	ids unauthorized-device-profile protect-ssid	wlsxAPDeauthContainment wlsxCliEntDeauthContainment wlsxTarpitContainment	106005, 106006, 126102, 126103, 126108, 127102, 127103, 127108
"Protecting Against Rogue Containment"	ids unauthorized-device-profile rogue-containment	wlsxAPDeauthContainment wlsxCliEntDeauthContainment	106005, 106006, 126102, 126103,

Feature	Command	Trap	Syslog ID
on page 382		wlsxTarpitContainment	126108, 127102, 127103, 127108
"Protecting Against Suspected Rogue Containment" on page 382	ids unauthorized-device-profile suspect-rogue-containment suspect-rogue-conf-level	wlsxAPDeauthContainment wlsxClientDeauthContainment wlsxTarpitContainment	106005, 106006, 106010, 126102, 126103, 126108, 127102, 127103, 127108

Protecting 40MHz 802.11 High Throughput Devices

Protection from AP(s) that support 40MHz HT involves containing the AP such that clients can not connect.

Protecting 802.11n High Throughput Devices

Protection from AP(s) that support HT involves containing the AP such that clients can not connect.

Protecting Against Adhoc Networks

Protection from an Ad hoc Network involves containing the ad hoc network so that clients can not connect to it.

Protecting Against AP Impersonation

Protection from AP impersonation involves containing both the legitimate and impersonating AP so that clients can not connect to either AP.

Protecting Against Misconfigured APs

Protect Misconfigured AP enforces that valid APs are configured properly. An offending AP is contained by preventing clients from associating to it.

Protecting SSIDs

Protect SSID enforces that valid/protected SSIDs are used only by valid APs. An offending AP is contained by preventing clients from associating to it.

Protecting Against Rogue Containment

By default, rogue APs are not automatically disabled. Rogue containment automatically disables a rogue AP by preventing clients from associating to it.

Protecting Against Suspected Rogue Containment

By default, suspected rogue APs are not automatically contained. In combination with the suspected rogue containment confidence level, suspected rogue containment automatically disables a suspect rogue by preventing clients from associating to it.

Understanding Client Intrusion Protection

[Table 108](#) list the client intrusion protection features with their related commands, traps, and syslog identifications. Details of each feature follow the table.

Table 108: Client Protection Summary

Feature	Command	Trap	Syslog ID
"Protecting Valid Stations" on page 383	ids unauthorized-device-profile protect-valid-sta	wlsxAPDeauthContainment wlsxCliEntDeauthContainment wlsxTarpitContainment	106005, 106006, 126102, 126103, 126108, 127102, 127103, 127108
"Protecting Windows Bridge" on page 383	ids unauthorized-device-profile protect-windows-bridge	wlsxAPDeauthContainment wlsxCliEntDeauthContainment wlsxTarpitContainment	106005, 106006, 126102, 126103, 126108, 127102, 127103, 127108

Protecting Valid Stations

Protecting a valid client involves disconnecting that client if it is associated to a non-valid AP.

Protecting Windows Bridge

Protecting from a Windows Bridge involves containing the client that is forming the bridge so that it can not connect to the AP.

Configuring the WLAN Management System (WMS)

The WLAN management system (WMS) on the controller monitors wireless traffic to detect any new AP or wireless client station that tries to connect to the network. When an AP or wireless client is detected, it is classified and its classification is used to determine the security policies which should be enforced on the AP or client.

In the WebUI

1. Navigate to the **Configuration > Advanced Services > Wireless** page.
2. Configure the parameters, as described in [Table 109](#). Then click **Apply**.

Table 109: WMS Configuration Parameters

Parameter	Description
Adhoc AP Ageout	The amount of time, in minutes, that an adhoc (IBSS) AP unseen by any probes before it is deleted from the database. Enter 0 to disable ageout. Default: 30 minutes
AP Ageout Interval	The amount of time, in minutes, that an AP is unseen by any probes before it is deleted from the database. Enter 0 to disable ageout. Default: 30 minutes
AM Poll Interval	Interval, in milliseconds, for communication between the controller and Dell AMs. The controller contacts the AM at this interval to download AP to STA associations, update policy configuration changes, and download AP and STA statistics. Default: 60000 milliseconds (1 minute)
Number of AM Poll Retries	Maximum number of failed polling attempts before the polled AM is considered to be down. Default: 3

Parameter	Description
Station Ageout Interval	The amount of time, in minutes, that a client is unseen by any probes before it is deleted from the database. Enter 0 to disable ageout. Default: 30 minutes
Enable Statistics Update in DB	Enables or disables statistics update in the database. Default: enabled
Collect Stat	Enables collection of statistics (up to 25,000 entries) on the master controller for monitored APs and clients. This only applies when MMS is not configured. Default: disabled
Learn System Wired Mac	Enable or disable "learning" of wired MACs at the controller. Default: disabled
Propagate Wired Mac	Enables the propagation of the gateway wired MAC information. Default: enabled
Mark Neighbor APs as Persistent Neighbor APs	Enables or disables APs that are marked as neighbor from being aged out. Default: enabled
Learn APs	Enables or disables AP learning. Learning affects the way APs are classified. Default: disabled

In the CLI

Use the following commands to configure WMS via the CLI. The parameters in this command are described in detail in [Table 109](#).

```
wms general
  adhoc-ap-ageout-interval <minutes> | ap-ageout-interval <minutes> | collect-stats
  {disable|enable} | learn-ap {enable|disable} | learn-system-wired-macs |
  persistent-neighbor {enable|disable} | poll-interval <milliseconds> |
  poll-retries <number> | propagate-wired-macs {enable|disable} | sta-ageout-interval
  <minutes> | stat-update {enable|disable}
```

Configuring Local WMS Settings

You can also use the CLI to define local WMS system settings for the maximum number of APs and client stations.

 NOTE: Use this command with caution. Increasing the limit will cause an increase in usage in the memory by WMS. In general, each entry will consume about 500 bytes of memory. If the setting is bumped up by 2000, then it will cause an increase in WMS memory usage by 1MB

```
(host) (config) #wms-local system max-threshold <max-threshold>
```

Managing the WMS Database

The WMS process interacts with all the air monitor (AM) processes in the network. When WMS receives an event message from an AM, the WMS process will save the event information along with the BSSID of the AP that generated the event in the WMS database. Use the following commands in **Enable** mode to manage the WMS database.

The **wms export-db** command exports the specified file as an ASCII text file into the WMS database.

```
(host) #wms export-db database <file>
```

The **wms import-db** command imports the specified file into the WMS database:

```
(host) #wms import-db database <file>
```

The **wms reint-db** command reinitializes the WMS database. Note that this command does not make an automatic backup of the current database.

```
(host) #wms reint-db
```

Understanding Client Blacklisting

When a client is blacklisted in the Dell system, the client is not allowed to associate with any AP in the network for a specified amount of time. If a client is connected to the network when it is blacklisted, a deauthentication message is sent to force the client to disconnect. While blacklisted, the client cannot associate with another SSID in the network.

The controller retains the client blacklist in the user database, so the information is not lost if the controller reboots. When you import or export the controller's user database, the client blacklist will be exported or imported as well.

Methods of Blacklisting

There are several ways in which a client can be blacklisted in the Dell system:

- You can manually blacklist a specific client. See ["Blacklisting Manually" on page 385](#) for more information.
- A client fails to successfully authenticate for a configured number of times for a specified authentication method. The client is automatically blacklisted. See ["Blacklisting by Authentication Failure " on page 386](#) for more information.
- A DoS or man in the middle (MITM) attack has been launched in the network. Detection of these attacks can cause the immediate blacklisting of a client. See ["Enabling Attack Blacklisting" on page 386](#) for more information.
- An external application or appliance that provides network services, such as virus protection or intrusion detection, can blacklist a client and send the blacklisting information to the controller via an XML API server. When the controller receives the client blacklist request from the server, it blacklists the client, logs an event, and sends an SNMP trap.

See [External Services Interface on page 748](#) for more information.



NOTE: The External Services Interface feature requires the Policy Enforcement Firewall Next Generation (PEFNG) license installed in the controller.

Blacklisting Manually

There are several reasons why you may choose to blacklist a client. For example, you can enable different Dell intrusion detection system (IDS) features that detect suspicious activities, such as MAC address spoofing or DoS attacks. When these activities are detected, an event is logged and an SNMP trap is sent with the client information. To blacklist a client, you need to know its MAC address.

To manually blacklist a client via the WebUI:

1. Navigate to the **Monitoring > Controller > Clients** page.
2. Select the client to be blacklisted and click the **Blacklist** button.

To clear the entire client blacklist using the WebUI:

1. Navigate to the **Monitoring > Controller > Clients** page.
2. Click **Remove All from Blacklist**.

To manually blacklist a client via the command-line interface, access the CLI in config mode and issue the following command:

```
stm add-blacklist-client <macaddr>
```

To clear the entire client blacklist using the command-line interface, access the CLI in config mode and issue the following command:

```
stm purge-blacklist-client
```

Blacklisting by Authentication Failure

You can configure a maximum authentication failure threshold for each of the following authentication methods:

- 802.1x
- MAC
- Captive portal
- VPN

When a client exceeds the configured threshold for one of the above methods, the client is automatically blacklisted by the controller, an event is logged, and an SNMP trap is sent. By default, the maximum authentication failure threshold is set to 0 for the above authentication methods, which means that there is no limit to the number of times a client can attempt to authenticate.

With 802.1x authentication, you can also configure blacklisting of clients who fail machine authentication.



NOTE: When clients are blacklisted because they exceed the authentication failure threshold, they are blacklisted indefinitely by default. You can configure the duration of the blacklisting; see ["Setting Blacklist Duration" on page 387](#).

To set the authentication failure threshold via the WebUI:

1. Navigate to the **Configuration > Security > Authentication > Profiles** page.
2. In the **Profiles** list, select the appropriate authentication profile, then select the profile instance.
3. Enter a value in the **Max Authentication failures** field.
4. Click **Apply**.

To set the authentication failure threshold via the command-line interface, access the CLI in config mode and issue the following commands:

```
aaa authentication {captive-portal|dot1x|mac|vpn} <profile>  
max-authentication-failures <number>
```

Enabling Attack Blacklisting

There are two type of automatic client blacklisting that can be enabled: blacklisting due to spoofed deauthentication, or blacklisting due to other types of DoS attacks.

Automatic blacklisting for DoS attacks other than spoofed deauthentication is enabled by default. You can disable this blacklisting on a per-SSID basis in the virtual AP profile.

Man in the middle (MITM) attacks begin with an intruder impersonating a valid enterprise AP. If an AP needs to reboot, it sends deauthentication packets to connected clients to enable them to disconnect and reassociate with another AP. An intruder or attacker can spoof deauthentication packets, forcing clients to disconnect from the network and reassociate with the attacker's AP. A valid enterprise client associates to the intruder's AP, while the intruder then associates to the enterprise AP. Communication between the network and the client flows through the intruder (the man in the middle), thus allowing the intruder the ability to add, delete, or modify data. When this type of attack is identified by the Dell system, the client can be blacklisted, blocking the MITM attack. Enable this blacklisting ability in the IDS DoS profile (this is disabled by default).

To enable spoofed deauth detection and blacklisting via the WebUI:

1. Navigate to the **Configuration > Wireless > AP Configuration** page.
2. Select either **AP Group** or **AP Specific** tab. Click **Edit** for the AP group or AP name.

3. In the Profiles list, expand the **IDS** menu, then select **IDS profile**.
4. Select the **IDS DOS profile**.
5. Select (check) **Spoofed Deauth Blacklist**.
6. Click **Apply**.

To enable spoofed deauth detection and blacklisting via the command-line interface, access the CLI in config mode, and issue the following commands:

```
ids dos-profile <profile>
spoofed-deauth-blacklist
```

Setting Blacklist Duration

You can configure the duration that clients are blacklisted on a per-SSID basis via the virtual AP profile. There are two different blacklist duration settings:

- For clients that are blacklisted due to authentication failure. By default, this is set to 0 (the client is blacklisted indefinitely).
- For clients that are blacklisted due to other reasons, including manual blacklisting. By default, this is set to 3600 seconds (one hour). You can set this to 0 to blacklist clients indefinitely.

To configure the blacklist duration via the WebUI:

1. Navigate to the **Configuration > Wireless > AP Configuration** page.
2. Select either **AP Group** or **AP Specific** tab. Click **Edit** for the AP group or AP name.
3. In the Profiles list, select **Wireless LAN**, then **Virtual AP**. Select the virtual AP instance.
 - To set a blacklist duration for authentication failure, enter a value for **Authentication Failure Blacklist Time**.
 - To set a blacklist duration for other reasons, enter a value for **Blacklist Time**.
4. Click **Apply**.

To configure the blacklist duration via the command-line interface, access the CLI in config mode and issue the following commands:

```
wlan virtual-ap <profile>
auth-failure-blacklist-time <seconds>
blacklist-time <seconds>
```

Removing a Client from Blacklisting

You can manually remove a client from blacklisting using either the WebUI or CLI:

To remove a client from blacklisting via the WebUI:

1. Navigate to the **Monitoring > Controller > Blacklist Clients** page.
2. Select the client that you want to remove from the blacklist, then click **Remove from Blacklist**.

To remove a client from blacklisting via the command-line interface, access the CLI in enable mode and issue the following command:

```
stm remove-blacklist-client <macaddr>
```

Working with WIP Advanced Features

Device Classification is the first step in securing the corporate environment from unauthorized wireless access. Adequate measures that quickly shut down intrusions are critical in protecting sensitive information and network

resources. APs and stations must be accurately classified to determine whether they are valid, rogue, or a neighboring AP. Then, an automated response can be implemented to prevent possible intrusion attempts.

TotalWatch™ allows for detecting devices that are running on typical operational channels. Tarpit Shielding provides a better way of containing devices that are deemed unauthorized. Both of these features are discussed in the sections that follow.

- ["Configuring TotalWatch" on page 388](#)
- ["Administering TotalWatch" on page 390](#)
- ["Working with Tarpit Shielding" on page 392](#)
- ["Configuring Tarpit Shielding" on page 392](#)

Configuring TotalWatch

Dell 802.11n APs and non-11n APs in AM-mode support for TotalWatch is the ability to scan all channels of the RF spectrum, including 2.4- and 5-GHz bands as well as the 4.9-GHz public safety band. TotalWatch also provides 5-MHz granular channel scanning of bands for rogue devices, and dynamic scanning dwell times to focus on those channels with traffic. TotalWatch provides an advanced set of features to detect unauthorized wireless devices and a set of customized rules are used to highlight devices that truly pose a threat to the network.



NOTE: TotalWatch is supported on APs deployed in the AM-mode only.

TotalWatch provides monitoring support for the entire WLAN spectrum. Dell APs in the AM-mode can *monitor* the following frequencies:

- 2412MHz to 2472MHz in the 2.5GHz band
- 5100Mhz to 5895MHz in the 5GHz band.

Dell APs in AM-mode can *scan* the following additional frequencies:

- 2484 MHz and 4900Mhz to 5000MHz (J-channels)
- 5000 to 5100Mhz

If the AP is HT-capable (High Throughput), then these frequencies are scanned in the 40MHz mode.

Understanding TotalWatch Channel Types and Qualifiers

Based on the regulatory characteristics, channels are categorized into the following types:

Reg-domain Channels—A channel that belongs to the regulatory domain of the country in which the AP is deployed. The set of channels that belong to this group is a subset of the channels in all-reg-domain channel group.

All-reg-domain Channels—A valid non-overlapping channel that is in the regulatory domain of at least one country. The channels in this category belong to the frequency range of:

- 2412MHz to 2472MHz in the g-band
- 5100Mhz to 5895MHz in the a-band.

Rare Channel—Channels that fall into a frequency range outside of the regulatory domain; 2484 MHz and 4900MHz-4995MHz (J-channels), and 5000-5100Mhz. The channels in this group do not belong to any other group.

Each of these channel types can have an associated qualifier:

Active Channel—This qualifier indicates that wireless activity is detected on this channel by the presence of an AP or other 802.11 activity; a probe requests for example.

DOS Channel—A channel where wireless containment is active. This channel should belong to the country-code channel (regulatory domain).

Understanding TotalWatch Monitoring Features

TotalWatch enables monitoring of all channels including regulatory domain and rare channels. You can select one of the following scanning modes for each radio AP.

- scan only the channels that belong to the AP's regulatory domain
- scan channels that belong to all regulatory domains
- scan all channels

Understanding TotalWatch Scanning Spectrum Features

TotalWatch scans the following frequencies.

- G-band—2412MHz to 2472MHz
- J band—2484 MHz
- A-band—5000-5100Mhz to 5895MHz
- J-band—4900-4995MHz

Table 110 list the frequency-to-channel mapping used by TotalWatch.

Table 110: Frequency to Channel Mapping

Frequency	Channel
2412 – 2472MHz (in increments of 5MHz)	1 - 13
2484MHz	14
5100 – 5895MHz (in increments of 5MHz)	20 - 179
4900 – 4995MHz (in increments of 5MHz)	180 - 199
5000 – 5100MHz	200 - 219

Understanding TotalWatch Channel Dwell Time

When an AP (in am-mode) visits a channel, the amount of time the AP *stays* on that channel is known as the *dwell time*. The channel dwell time is a variable value based on the following channel types.

dwell-time-active-channel—For channels where there is wireless activity. Default setting is 500 ms.

dwell-time-reg-domain channel—For channels that belong to the AP's regulatory domain group (reg-domain) with *no* wireless activity. The default setting is 250 ms.

dwell-time-other-reg-domain-channel—For channels that belong to the *all* regulatory domain group (all-reg-domain) with *no* wireless activity. The default setting is 250 ms.

dwell-time-rare-channel—For channels in the rare group where *no* wireless activity is detected. The default value is 100 ms.

Use the `rf am-scan-profile` command to set the dwell time and scan mode.

Understanding TotalWatch Channel Visiting

The Active and DOS channels are visited more frequently than the other channels. The order of preference in selecting the next channel is:

1. DOS
2. Active
3. reg-domain
4. All-reg-domain
5. Rare

Once a channel is selected, the dwell time for that channel is determined based on the channel type. At the end of the dwell time, a new channel is picked.

Understanding TotalWatch Age out of Devices

ArubaOS uses a combination of inactivity time and unseen time to age out a device. This ensures that the channel is scanned a sufficient number of times before a device ages out. AM module maintains the following parameters:

Discovered Time—The absolute time, in seconds, since the device was discovered.

Monitored Time—The number of times the channel was scanned since discovery.

Inactivity Time—The number of times the device was not “seen” when the channel is scanned.

Unseen Time—The absolute time, in seconds, since the device was last “seen.”

Administering TotalWatch

The AM module will initialize the channel list for each of the AP’s radio based on the scan mode setting for the radio. For example, if scan mode is set to rare, then the channel list will contain all possible channels. You can view these channels by using the `show ap arm scan-times` command.

Configuring Per Radio Settings

For each radio, you can configure the following settings (for detailed information on commands, refer to the *Dell PowerConnect W-Series ArubaOS 6.2 Command Line Interface Guide*):

- the dwell times for the various channel types
- the channel list that should be used for scanning

These settings are configured via the command `rfam-scan-profile`, which can be attached to the two profiles, `dot11a-radio-profile` and `dot11g-radio-profile`.

The am-scan-profile includes the following parameters that can be configured:

```
rf am-scan-profile <name>
scan-mode [reg-domain | all-reg-domain | rare]
```

The default setting is the all-reg-domain. This is consistent with the default functioning of the AM scanning where the radio scans channels belonging to all regulatory domains.

Configuring Per AP Setting

If the AP is a dual-band single radio AP, an option is available to specify which band should be used for scanning in AM-mode. This setting is available in the “ap system-profile”, via the `am-scan-rf-band` command.

```
ap system-profile <name>
am-scan-rf-band [a | g | all]
```

The default value is “all”, which is consistent with the prior behavior. This setting is ignored in the case of a dual radio AP.

There are four parameters that will control the age out of devices in the AM module.

```
ids general-profile <name>
ap-inactivity-timeout
sta-inactivity-timeout
ap-max-unseen-timeout
sta-max-unseen-timeout
```

The inactivity timeout is the number of times the device was not “seen” when the channel was scanned. The unseen timeout is the time, in seconds, since the device was last “seen.”

The **show ap monitor scan-info/channel** commands provide details of the channel types, dwell times, and the channel visit sequence.

```
(host) # show ap monitor scan-info ap-name rb-121
```

```
WIF Scanning State: wifi0
```

```
-----
Parameter                               Value
-----
Scan Mode                                all-reg-domain
Scan Channel                             yes
Disable Scanning                         no
Current Channel                          36-
Current Scan Channel                     36-
Current Channel Index                    1
Current Scan Start Milli Tick            351757100
Current Dwell Time                       600
Current Scan Type                        active
```

```
Scan-Type-Info
```

```
-----
Info-Type      Active  Reg-domain  All-reg-domain  Rare  DOS
-----
Dwell Times    600    250        100             100   600
Last Scan Channel 36-    116-       0               0     0
```

```
(host) #show ap monitor channel ap-name rb-121 36
```

```
Aggregate Stats
```

```
-----
retry  low-speed  non-unicast  frag  bwidht  phy-err  mac-err  noise
-----
0      0           0           0     1       0        9        90
```

```
Scanning Stats
```

```
-----
scans-attempted  assign-time(ms)  last-visit-time  monitored-time  reside-time(ms)  dos-scans
flags
-----
42702            25620500        402424           56245           0
0                DVACLU
```

```
Channel Flags: D: Default, V: Valid, A: AP Present, C: Reg Domain Channel,
O: DOS Channel, Z: Rare Channel
T: Valid 20MHZ Channel, F: Valid 40MHZ Channel,
L: Scan 40MHZ Channel (lower), U: Scan 40MHZ channel (upper)
R: Radar detected in last 30 min, X: DFS required
```

Licensing

The ability to perform rare scanning is available only with the RFprotect license. However, the AP can scan ‘reg-domain’ or ‘all-reg-domain’ channels without the RFprotect license.

Working with Tarpit Shielding

The Tarpit Shielding feature is a type of wireless containment. Detected devices that are classified as rogues are contained by forcing client association to a fake channel or BSSID. This method of tarpitting is more efficient than rogue containment via repeated de-authorization requests. Tarpit Shielding works by spoofing frames from an AP to *confuse* a client about its association. The *confused* client assumes it is associated to the AP on a different (fake) channel than the channel that the AP is actually operating on, and will attempt to communicate with the AP in the fake channel.

Tarpit Shielding works in conjunction with the *death* wireless containment mechanism. The *death* mechanism triggers the client to generate probe request and subsequent association request frames. The AP then responds with probe response and association response frames. Once the monitoring AP sees these frames, it will spoof the probe-response and association response frames, and manipulates the content of the frames to confuse the client.

A station is determined to be in the Tarpit when we see it sending data frames in the fake channel. With some clients, the station remains in tarpit state until the user manually disables and re-enables the wireless interface.

Configuring Tarpit Shielding

Tarpit shielding is configured on an AP using one of two methods:

Disable all clients—In this method, any client that attempts to associate with an AP marked for containment is sent spoofed frames.

Disable non-valid clients—In this method, only non-authorized clients that attempt to associate with an AP is sent to the tarpit.

The choices for disabling Tarpit Shielding on an AP are:

- `Death-wireless-containment`
- `Death-wireless-containment with tarpit-shielding (excluding-valid-clients)`
- `Death-wireless-containment with tarpit-shielding`

Enabling Tarpit Shielding

Use the `ids-general-profile` command to configure Tarpit Shielding (for detailed information on commands refer to the *Command Line Reference Guide*).

```
ids general-profile default
  wireless-containment [death-only | none | tarpit-all-sta | tarpit-non-valid-sta]
```

Use the following show commands to view updated Tarpit Shielding status and the spoofed frames generated for an AP:

```
show ap monitor stats ...
show ap monitor containment-info
```

Understanding Tarpit Shielding Licensing CLI Commands

In the `ids general-profile default wireless-containment` command, the ‘tarpit-non-valid-sta’ and ‘tarpit-all-sta’ options are available only with a RFprotect license. The ‘death-only’ and ‘none’ options are available with the Base OS license.

Chapter 23

Access Points (APs)

In ArubaOS, related configuration parameters are grouped into *profiles* that you can apply as needed to an AP group or to individual APs. When an AP is first installed on the network and powered on, the AP locates its host controller and the AP's designated configuration is "pushed" from the controller to the AP. This chapter gives an overview of the basic function of each AP profile, and describes the process to install and configure the APs on your network.

The following topics are included in this chapter:

- "Basic Functions and Features" on page 393
- "Understanding AP Configuration Profiles" on page 396
- "Profile Hierarchy " on page 401
- "Deploying APs" on page 404
- "Provisioning Installed APs" on page 409
- "Configuring a Provisioned AP" on page 415
- "RF Management " on page 424
- "Configuring AP Channel Assignments" on page 435
- "Managing AP Console Settings" on page 437

Basic Functions and Features

You configure APs using the WebUI and the CLI on the controller. [Table 111](#) list the basic configuration functions and features.

Table 111: AP Configuration Function Overview

Features and Function	Description
Wireless LANs	A wireless LAN (WLAN) permits wireless clients to connect to the network. An AP broadcasts the SSID (which corresponds to a WLAN configured on the controller) to wireless clients. APs support multiple SSIDs. WLAN configuration includes the authentication method and the authentication servers by which wireless users are validated for access. The WebUI includes a WLAN Wizard that provides easy-to-follow steps to configure a new WLAN. NOTE: All new WLANs are associated with the ap-group named "default".
AP operation	A Dell AP can function as an AP that serves clients, as an air monitor (AM) performing network and radio frequency (RF) monitoring, or as a hybrid AP that both serves clients and performs spectrum analysis a single radio channel. You can also specify the regulatory domain (the country) which determines the 802.11 transmission spectrum in which the AP will operate. Within the regulated transmission spectrum, you can configure 802.11a, 802.11b/g, or 802.11n (high-throughput) radio settings. NOTE: The 802.11n features, such as high-throughput and 40 MHz configuration settings, are supported on APs that are 802.11n standard compliant.
Quality of Service (QoS)	Configure Voice over IP call admission control options and bandwidth allocation for 5 GHz (802.11a) or 2.4 GHz (802.11b/g) frequency bands of traffic.

Features and Function	Description
RF Management	Configure settings for balancing wireless traffic across APs, detect holes in radio coverage, or other metrics that can indicate interference and potential problems on the wireless network. Adaptive Radio Management (ARM) is an RF spectrum management technology that allows each AP to determine the best 802.11 channel and transmit power settings. ARM provides several configurable settings.
Intrusion Detection System	Configure settings to detect and disable rogue APs, ad-hoc networks, and unauthorized devices, and prevent attacks on the network. You can also configure signatures to detect and prevent intrusions and attacks.
Mesh	Configure Dell APs as mesh nodes to bridge multiple Ethernet LANs or extend wireless coverage. A mesh node is either <ul style="list-style-type: none"> • a mesh portal—an AP that uses its wired interface to reach the controller • or a mesh point—an AP that establishes a path to the controller via the mesh portal Mesh environments use a wireless backhaul to carry traffic between mesh nodes. This allows one 802.11 radio to carry traditional WLAN services to clients and one 802.11 radio to carry mesh traffic as well as WLAN services. Secure Enterprise Mesh on page 439 contains more specific information on the Mesh feature.

Naming and Grouping APs

In the Dell user-centric network, each AP has a unique name and belongs to an AP group.

Each AP is identified with an automatically-derived name. The default name depends on if the AP has been previously configured.

- The AP has not been configured—the name is the AP’s Ethernet MAC address in colon-separated hexadecimal digits.
- Configured with a previous ArubaOS release—the name is in the format *building.floor.location*

You can assign a new name (up to 63 characters) to an AP; the new name must be unique within your network. For example, you can rename an AP to reflect its physical location within your network, such as “building3-lobby”.



WARNING: Renaming an AP requires a reboot of the AP before the new name takes effect. Therefore, if you need to do this, there should be little or no client traffic passing through the AP.

In RF Plan or RF Live, the AP name can be part of a fully-qualified location name (FQLN) in the format *APname.floor.building.campus*. The *APname* portion of the FQLN must be unique.

An *AP group* is a set of APs to which the same configuration is applied. There is an AP group called “default” to which all APs discovered by the controller are assigned. By using the “default” AP group, you can configure features that are applied globally to all APs.

You can create additional AP groups and assign APs to that new group. However, an AP can belong to only one AP group at a time. For example, you can create an AP group “Victoria” that consists of the APs that are installed in a company’s location in British Columbia. You can create another AP group “Toronto” that consists of the APs in Ontario. You can configure the “Toronto” AP group with different information from the APs in the “Victoria” AP group (see [Figure 112](#)).

Figure 112: AP Groups

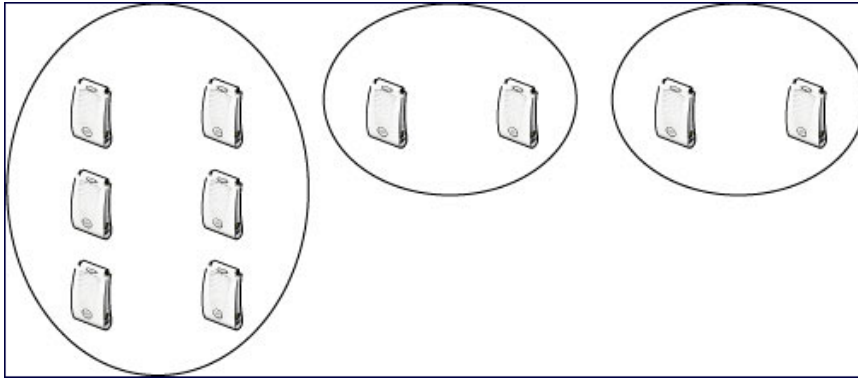

While you can use an AP group to apply a feature to a set of APs, you can also configure a feature or option for a specific AP by referencing the AP's name. Any options or values that you configure for a specific AP will override the same options or values configured for the AP group to which the AP belongs.

The following procedures describes how to create an AP group and, because all discovered APs initially belong to the AP group named “default”, how to reassign an AP to your newly-created AP group.



NOTE: Reassigning an AP from an AP group requires a reboot of the AP for the new group assignment to take effect. Therefore, if you need to do this, there should be little or no client traffic passing through the AP.

Creating an AP group

You can use the WebUI or the CLI to create a new AP group.

In the WebUI

1. Navigate to the **Configuration > Wireless > AP Configuration > AP Group** page.
2. Click **New**. Enter the new AP group name and click **Add**. The new AP group appears in the Profile list.

In the CLI

Use the following command to create an AP group:

```
ap-group <group>
```

When you create an AP group with the CLI, you can specify the virtual AP definitions and configuration profiles you want applied to the APs in the group.

Assigning APs to an AP Group

Although you will assign an AP to an AP group when you first deploy the device, you can assign an AP to a different AP group at any time.



NOTE: Once the **ap-regroup** command is executed, the AP automatically reboots. If the AP is powered off or otherwise not connected to the network or controller, the executed command is queued until the AP is powered on or reconnected. Again, the AP will automatically reboot as soon as the command is executed.

In the WebUI

1. Navigate to the **Configuration > Wireless > AP Installation** page. The list of discovered APs appears in this page (all discovered APs initially belong to the AP group named “default”).

2. Select the AP you want to reassign, and click **Provision**. From the Provisioning page, select the AP group from the drop-down menu.
3. Click **Apply and Reboot**.

In the CLI

Use the following command to assign a single AP to an existing AP group. Use the WebUI to assign multiple APs to an AP group at the same time.

```
ap-regroup {ap-name <name>|serial-num <number>|wired-mac <macaddr>} <group>
```

Understanding AP Configuration Profiles

An AP configuration profile is a general name to describe any of the different groups of settings that can be defined, saved, and applied to an Access Point. ArubaOS has many different types of profiles that each allow you to configure a different aspect of an AP's overall configuration. ArubaOS also contains a predefined "default" profile for each profile type. You can use the predefined settings in these default profiles, or create entirely new profiles that you can edit as required.

Each different AP configuration profile type can be managed using the CLI or the WebUI. To see a full list of available configuration profiles using the command-line interface, access the CLI and issue the command **show profile-hierarchy**. To view available configuration profiles using the WebUI, select the **Configuration** tab in the and navigate to **Advanced Services>All Profiles**.

The **All Profiles** tab arranges the different AP configuration profile types into the following six categories:

- ["Working with Wireless LAN Profiles" on page 396](#)
- ["Working with AP Profiles" on page 399](#)
- ["Working with QoS Profiles" on page 399](#)
- ["Working with RF Management Profiles" on page 400](#)
- ["Provisioning Mesh Profiles" on page 400](#)
- ["Other Profiles" on page 401](#)

Working with Wireless LAN Profiles

The Wireless LAN collection of profiles configure WLANs in the form of virtual AP profiles. A virtual AP profile contains an SSID profile which defines the WLAN, the high-throughput SSID profile, and an AAA profile that defines the authentication for the WLAN.

Unlike other profile types, you can configure and apply multiple instances of virtual AP profiles to an AP group or to an individual AP.

- **802.11k profile**—Manages settings for the 802.11k protocol. The 802.11k protocol allows APs and clients to dynamically query their radio environment and take appropriate connection actions. For example: In a 802.11k network if the AP with the strongest signal reaches its CAC (Call Admission Control) limits for voice calls, then *on-hook* voice clients may connect to an under utilized AP with a weaker signal. You can configure the following options in 802.11k profile:
 - Enable or disable 802.11K support on the AP
 - Forceful disassociation of on-hook voice clients
 - Measurement mode for beacon reports.

For more details, see ["Enabling 802.11k Support" on page 333](#).

- **Handover Trigger profile**— Configure a handover trigger profile to ensure QoS for voice calls for APs with the 802.11k feature enabled. For more details, see ["Enabling Wi-Fi Edge Detection and Handover for Voice Clients" on page 709](#)
- **RRM IE profile**—Configure a Radio Resource Management Information Element (RRM IE) profile to define the information elements advertised by an AP with 802.11k support enabled. For more details, see ["Working with Radio Resource Management Information Elements" on page 336](#)
- **Beacon Report Request Profile**—APs with the 802.11k feature enabled use request messages to solicit measurements. This profile defines the information an AP can send in beacon report requests.
- **TSM Report Request Profile**—APs with the 802.11k feature enabled use request messages to solicit measurements. This profile defines the information an AP can send in traffic stream measurement reports.
- **SSID profile**—Configures network authentication and encryption types. This profile also includes references to the EDCA (enhanced distributed channel access) Parameters Station Profile, the EDCA Parameters AP Profile and a High-throughput SSID profile.

Use this profile to configure basic settings such as 802.11 authentication and encryption settings, or advanced settings such as DTIM (delivery traffic indication message) intervals, 802.11a/802.11g basic and transmit rates, DHCP settings and WEP keys. The advanced SSID profile settings allows you to deny broadcast probes and hide the SSID. For details on configuring an SSID profile, see ["Creating a new SSID Profile" on page 324](#).



NOTE: Beacon rates for 802.11a and 802.11g beacon should only be configured on APs with Distributed Antenna Systems (DAS). Configuring beacon rates during normal operation may cause connectivity problems.

- **High-throughput SSID profile**—High-throughput APs support additional settings not available in legacy APs. A High-throughput SSID profile enables/disables high-throughput (802.11n) features with 40 MHz channel usage, and define values for aggregated MAC protocol data units (MDPUs) and Modulation and Coding Scheme (MCS) ranges. If you modify a currently provisioned and running high-throughput SSID profile, your changes take effect immediately; rebooting is not required. For details on configuring a high-throughput SSID profile, see [Table 95](#).
- **Virtual AP profile**—This profile defines your WLAN by enabling or disabling the band steering, fast roaming and DoS prevention features. It defines radio band, forwarding mode and blacklisting parameters, and includes references to an AAA Profile, 802.11K Profile, and a High-throughput SSID profile. You can apply multiple virtual AP profiles to an AP group or to an individual AP; for most other profiles, you can apply only one instance of the profile to an AP group or AP at a time. For details on configuring a Virtual AP profile, see [Table 88](#).
- **VIA client WLAN profile**—The VIA client WLAN profile settings are similar to the authentication settings used to set up a wireless network. For details and examples, see ["Configure VIA Client WLAN Profiles" on page 562](#).
- **AAA profile**—This defines authentication settings for the WLAN users, including the role for unauthenticated users, and the different roles that should be assigned to users authenticated via 802.1x, MAC or SIP authentication. This profile includes references to:
 - MAC Authentication Profile
 - MAC Authentication Server Group
 - 802.1X Authentication Profile
 - 802.1X Authentication Server Group
 - RADIUS Accounting Server Group

For details on configuring an AAA profile, see ["AAA Profile Parameters" on page 319](#).

- **XML API server profile**—Specifies the IP address of an external XML API server. For additional information, see ["Configuring the XML API Server" on page 779](#).
- **RFC 3576 server**—Specifies the IP address of a RFC 3576 RADIUS server. For additional information, see ["Configuring an RFC-3576 RADIUS Server" on page 171](#).

- **MAC authentication profile**—Defines parameters for MAC address authentication, including upper- or lower-case MAC string, the diameter format in the string, and the maximum number of authentication failures before a user is blacklisted. For additional information, see ["Configuring the MAC Authentication Profile" on page 189](#).
- **Captive portal authentication profile**—This profile directs clients to a web page that requires them to enter a username and password before being granted access to the network. This profile defines login wait times, the URLs for login and welcome pages, and manages the default user role for authenticated captive portal clients. You can also set the maximum number of authentication failures allowed per user before that user is blacklisted. This profile includes a reference to a Server group profile. For complete information on configuring a Captive portal authentication profile, refer to [Captive Portal Authentication on page 233](#).
- **WISPR authentication profile**—WISPr authentication allows a “smart client” to authenticate on the network when they roam between Wireless Internet Service Providers, even if the wireless hotspot uses an ISP for which the client may not have an account. For more information on configuring WISPr authentication, see ["Configuring WISPr Authentication" on page 225](#).
- **802.1x authentication profile**—Defines default user roles for machine or 802.1x authentication, and parameters for 802.1x termination and failed authentication attempts. For a list of the basic parameters in the 802.1x authentication profile, refer to [802.1X Authentication on page 192](#)
- **RADIUS server profile**—Identifies the IP address of a RADIUS server and sets RADIUS server parameters such as authentication and accounting ports and the maximum allowed number of authentication retries. For a list of the parameters in the RADIUS profile, refer to ["Configuring a RADIUS Server" on page 169](#)
- **LDAP server profile**—Defines an external LDAP authentication server that processes requests from the controller. This profile specifies the authentication and accounting ports used by the server, as well as administrator passwords, filters and keys for server access. For a list of the parameters in the LDAP profile, refer to ["Configuring an LDAP Server" on page 172](#)
- **TACACS server profile**—Specifies the TCP port used by the server, the timeout period for a TACACS+ request, and the maximum number of allowed retries per user. For a list of the parameters in the TACACS profile, refer to ["Configuring a TACACS+ Server" on page 173](#)
- **Server group**—This profile manages groups of servers for specific types of authentication. Server Groups identify individual authentication servers and let you create rules for clients based on attributes returned for the client by the server during authentication. For additional information on configuring server rules, see ["Configuring Server-Derivation Rules" on page 182](#)
- **VPN Authentication profile**—This profile identifies the default role for authenticated VPN clients and also references a server group. It also provides a separate VPN AAA authentication for a terminating remote AP (default-rap) and a campus AP (default-CAP). If you want to simultaneously deploy various combinations of a VPN client, RAP-psk, RAP-certs and CAP on the same controller, see [Table 76](#).
- **Management authentication profile**—Enables or disables management authentication, and identifies the default role for authenticated management clients. This profile also references a server group. For more information on configuring a management authentication profile, see ["Management Authentication Profile Parameters" on page 634](#).
- **Wired authentication profile**—This profile merely references an AAA profile to be used for wired authentication. See ["Securing Wired Clients" on page 672](#).
- **Stateful 802.1x authentication Profile**—Enables or disables 802.1x authentication for clients on non-Dell APs, and defines the default role for those users once they are authenticated. This profile also references a server group to be used for authentication. For details on configuring stateful authentication, see ["Stateful and WISPr Authentication" on page 221](#).
- **Stateful Kerberos Authentication**— Use stateful Kerberos authentication to configure a controller to monitor the Kerberos authentication messages between a client and a Windows authentication server. If the client successfully authenticates via an Kerberos authentication server, the controller can recognize that the client has

been authenticated and assign that client a specified user role. For more information on stateful Kerberos authentication, see ["Configuring Stateful Kerberos Authentication" on page 224](#).

- **Stateful NTLM authentication Profile**—Monitor the NTLM (NT LAN Manager) authentication messages between clients and an authentication server. If the client authenticates via an NTLM authentication server, the controller can recognize that the client has been authenticated and assign that client a specified user role. For details on configuring stateful authentication, see ["Stateful and WISPr Authentication" on page 221](#).

Working with AP Profiles

The AP profiles configure AP operation parameters, radio settings, port operations, regulatory domain, and SNMP information.

- **AP system profile**—Defines administrative options for the controller, including the IP addresses of the local, backup, and master Dell controllers, Real-time Locating Systems (RTLS) server values and the number of consecutive missed heartbeats on a GRE tunnel before an AP reboots. For details on configuring this profile, see [Table 120](#).
- **Regulatory domain**—Defines the AP's country code and valid channels for both legacy and high-throughput 802.11a and 802.11b/g radios. For examples on figuring a regulatory domain profile, see ["Configuring AP Channel Assignments" on page 435](#).
- **Wired AP profile**—Determines if 802.11 frames are tunneled to the controller using Generic Routing Encapsulation (GRE) tunnels, bridged into the local Ethernet LAN, or configured for a combination of the two (split-mode). In tunnel forwarding mode, the AP handles all 802.11 association requests and responses, but sends all 802.11 data packets, action frames and EAPOL frames over a GRE tunnel to the controller for processing. When a remote AP or campus AP is in bridge mode, the AP handles all 802.11 association requests and responses, encryption/decryption processes, and firewall enforcement. In split-tunnel mode, 802.11 frames are either tunneled or bridged, depending on the destination (corporate traffic goes to the controller, and Internet access remains local). For details, see ["Configuring Ethernet Ports for Mesh" on page 464](#)
- **Ethernet interface profile**—Sets the duplex mode and speed of the AP's Ethernet link. The configurable speed is dependent on the port type, and you can define a separate Ethernet Interface profile for each Ethernet link. For details on configuring this profile, see [Table 121](#).
- **Ethernet Interface Port/Wired Port Profile**—Specifies a AAA profile for users connected to the wired port on an AP. For details on configuring this profile, see ["Securing Clients on an AP Wired Port" on page 675](#)
- **AP Provisioning profile**—Defines a group of provisioning parameters for an AP or AP group. For details on configuring this profile, see [Table 119](#).
- **AP Authorization Profile**—Allows you to assign an to a provisioned but unauthorized AP to a AP group with a restricted configuration profile. For details see ["Configuring Remote AP Authorization Profiles" on page 534](#).
- **EDCA parameters profile (Station)**—Client to AP traffic prioritization parameters, including Enhanced Distributed Channel Access (EDCA) parameters for background, best-effort, voice and video queues. For additional information on configuring this profile, see ["Using the WebUI to configure EDCA parameters" on page 701](#).
- **EDCA parameters profile (AP)**—AP to client traffic prioritization, including EDCA parameters for background, best-effort, voice and video queues. For additional information on configuring this profile, see ["Using the WebUI to configure EDCA parameters" on page 701](#).

Working with QoS Profiles

The QoS profiles configure traffic management and VoIP functions.

- **VoIP call admission control profile**—Dell's Voice Call Admission Control limits the number of active voice calls per AP by load-balancing or ignoring excess call requests. This profile enables active load balancing and call

admission controls, and sets limits for the numbers of simultaneous Session Initiated Protocol (SIP), SpectraLink Voice Priority (SVP), Cisco Skinny Client Control Protocol (SCCP), Vocera or New Office Environment (NOE) calls that can be handled by a single radio. For additional information on configuring this profile, see ["Scanning for VoIP-Aware ARM " on page 704](#).

- **Traffic management profile**—Specifies the minimum percentage of available bandwidth to be allocated to a specific Virtual AP when there is congestion on the wireless network, and sets the interval between bandwidth usage reports. For additional information on configuring this profile, see [Table 98](#).
- **WMM Traffic management profile**—The profile for Wi-Fi Multi-Media (WMM) traffic management prioritizes voice and video traffic above other data traffic . For additional information on configuring this profile, see ["Voice and Video" on page 682](#).

Working with RF Management Profiles

The profiles configure radio tuning and calibration, AP load balancing, and RSSI metrics.

- **802.11a radio profile**—Defines AP radio settings for the 5 GHz frequency band, including the Adaptive Radio Management (ARM) profile and the high-throughput (802.11n) radio profile. For additional information on configuring this profile, see ["802.11a and 802.11g RF Management Profiles" on page 424](#).
- **802.11g radio profile**—Defines AP radio settings for the 2.4 GHz frequency band, including the Adaptive Radio Management (ARM) profile and the high-throughput (802.11n) radio profile. Each 802.11a and 802.11b radio profile includes a reference to an Adaptive Radio Management (ARM) profile.

If you want the ARM feature to dynamically select the best channel and transmission power for the radio, verify that the 802.11a/802.11g radio profile references an active and enabled ARM profile. If you want to manually select a channel for each AP group, create separate 802.11a and 802.11g profiles for each AP group and assign a different transmission channel for each profile. For additional information on configuring this profile, see ["802.11a and 802.11g RF Management Profiles" on page 424](#).

- **ARM profile**—Defines the Adaptive Radio Management (ARM) settings for scanning, acceptable coverage levels, transmission power and noise thresholds. In most network environments, ARM does not need any adjustments from its factory-configured settings. However, if you are using VoIP or have unusually high security requirements you may want to manually adjust the ARM thresholds. For complete details on Adaptive Radio Management, refer to [Adaptive Radio Management \(ARM\) on page 346](#).
- **High-throughput radio profile**—Manages high-throughput (802.11n) radio settings for 802.11n-capable APs. A high-throughput profile determines 40 Mhz tolerance settings, and controls whether or not the APs using this profile will advertise intolerance of 40 MHz operation. (This option is disabled by default, allowing 40 MHz operation.) For additional information on configuring this profile, see ["Configuring a High-Throughput Virtual AP" on page 340](#).
- **RF optimization profile**—Enables or disables load balancing based on a user-defined number of clients or degree of AP utilization on an AP. Use this profile to detect coverage holes, radio interference and STA association failures and configure Received signal strength indication (RSSI) metrics.
- **RF event thresholds profile**—Defines error event conditions, based on a customizable percentage of low-speed frames, non-unicast frames, or fragmented, retry or error frames. For additional information on configuring this profile, see ["RF Event Configuration" on page 433](#).
- **Spectrum Profile**—Defines the ageout times for devices seen by a spectrum monitor. For more information about the spectrum profile default settings, see ["Understanding Device Ageout Times" on page 613](#).

Provisioning Mesh Profiles

You can provision Dell APs to operate as mesh points, mesh portals or remote mesh portals. The secure enterprise mesh environment routes network traffic between APs over wireless hops to join multiple Ethernet LANs or to extend wireless coverage. The Mesh profiles are:

- **Mesh high-throughput SSID profile**—Enables or disables high-throughput (802.11n) features and 40 Mhz channel usage, and define values for aggregated MAC protocol data units (MDPUs) and Modulation and Coding Scheme (MCS) ranges. If none of the APs in your Mesh deployment are 802.11n-capable, you do not need to configure a mesh high-throughput SSID profile. For additional information on configuring this profile, see ["Working with Mesh High Throughput SSID Profiles " on page 455](#).
- **Mesh radio profile**—Determines many of the settings used by mesh nodes to establish mesh links and the path to the mesh portal, including the maximum number of children a mesh node can accept, and transmit rates for the 802.11a and 802.11g radios. For additional information on configuring this profile, see ["Working with Mesh Radio Profiles" on page 450](#).
- **Mesh cluster profile**—Contains the mesh cluster name (MSSID), authentication methods, security credentials, and cluster priority. For additional information on configuring this profile, see ["Understanding Mesh Cluster Profiles" on page 459](#).

Other Profiles

These controller profiles set the management password policy, define equipment OUIs, or configure VIA authentication and connection settings.

- **Valid Equipment OUI Profile**—Set one or more Dell OUIs for the controller.
- **VIA Authentication Profile**—Define an authentication profile for the VIA feature.
- **VIA Connection Profile**—Define authentication and connection settings profile for the VIA feature.
- **VIA Web Authentication**—Define a VIA authentication profile to be used for Web authentication.
- **VIA Global Configuration**—Select whether or not the controller should allow VIA SSL fallback.
- **Management Password Policy**—Define a policy for creating management passwords.
- **Dialplan Profile**—Define SIP dial plans on the controller to provide outgoing PSTN calls.
- **Spectrum Local Override Profile**—Configure an individual AP radio as a spectrum monitor, For details, see ["Converting an Individual AP to a Spectrum Monitor" on page 575](#).

Viewing Profile Errors

To view the list of profile errors using the CLI, use the `show profile-errors` command. The WebUI displays them with a *flag* icon next to the main horizontal menu ([Figure 113](#)). Click the flag to view the list of errors.

Figure 113: Profile Errors

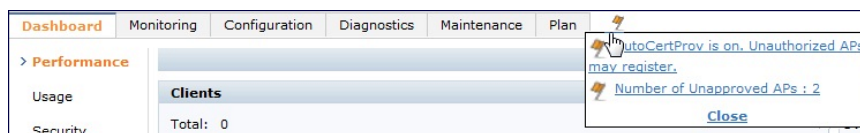

Profile Hierarchy

ArubaOS WebUI includes several wizards that allow you to configure an AP, controller, WLAN, or License installation. You can also configure profiles using the WebUI Profile list or via the command line interface. Best practices is to configure the lowest-level settings first. For example, if you are defining a virtual AP profile, you should first define a session policy, then define your server group, then create an AAA profile that references the session policy and your server group.

[Figure 114](#) represents the AP and AP Group profile hierarchy in the WebUI (navigate to **Configuration > AP configuration**).

Figure 114: AP Specific and AP Group Profile Hierarchies

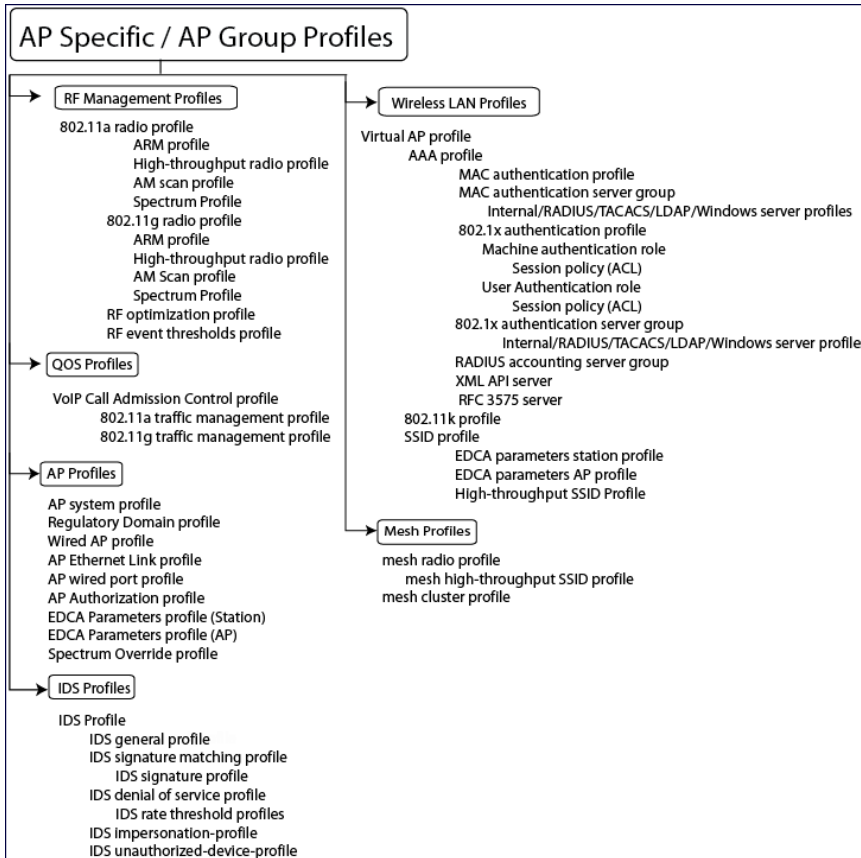
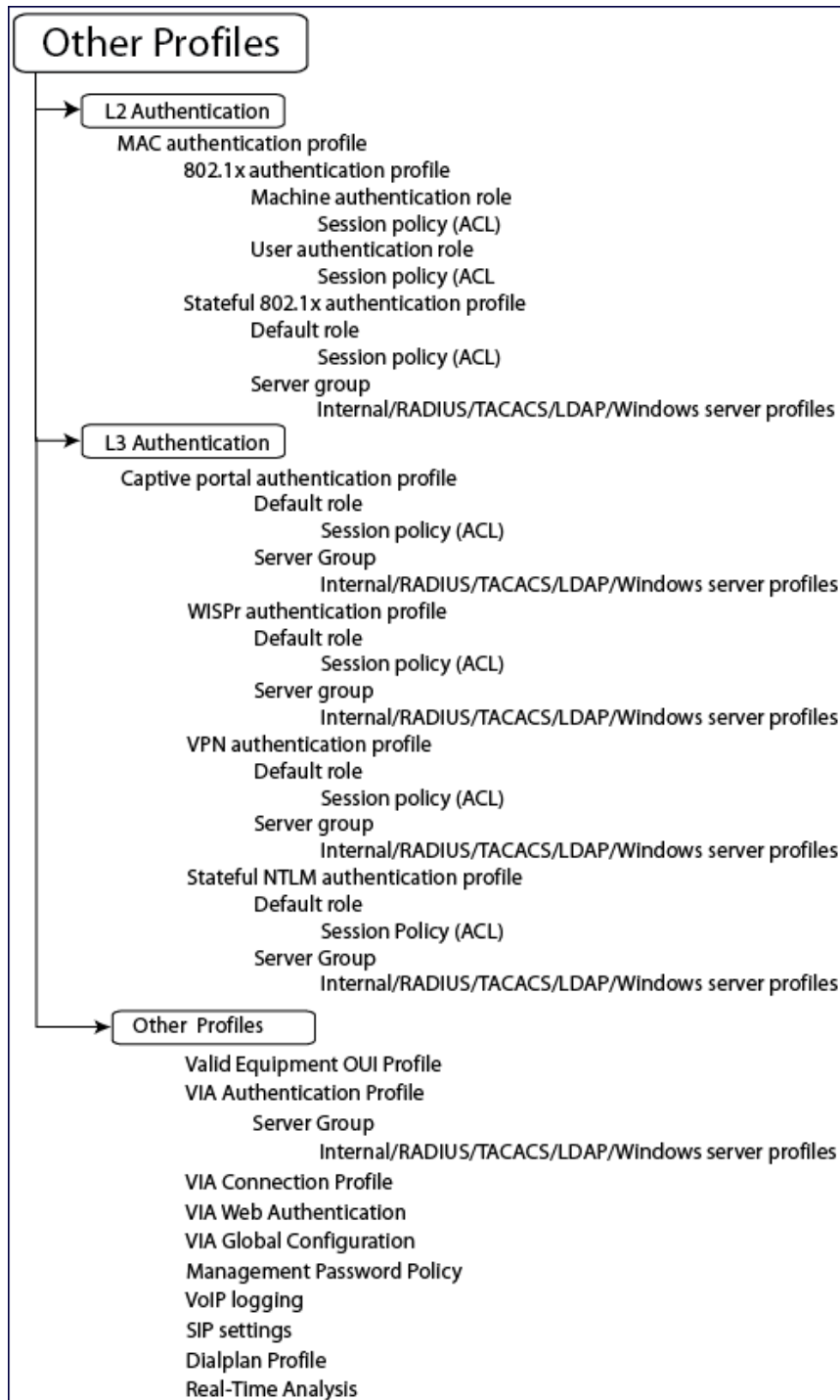

Figure 115 displays how other higher-level configuration profiles reference other profiles. To view the profile hierarchy for Layer 2 authentication profiles in the WebUI, navigate to **Configuration > Authentication** and select the **L2 Authentication** tab. To view the profile hierarchy for Layer 3 authentication profiles, navigate to **Configuration > Authentication** and select the **L3 Authentication** tab.

Figure 115: Other Profile Hierarchies



Deploying APs

Dell APs and AMs are designed to require only minimal setup to make them operational in an user-centric network. Once APs have established communication with the controller, you can apply advanced configuration to individual APs or groups of APs in the network using the WebUI on the controller.

Deploy APs on your network using the following steps:

1. Run the Java-based RF Plan tool to help position APs and import floorplans for your installation.
2. Prior to installation, configure firewall settings and enable controller discovery so the APs can locate and identify the controller.
3. Ensure that APs will be able to obtain an IP address once they are connected to the network.

 NOTE: If you are deploying APs in a mesh networking environment, best practices are to define the mesh cluster profile and mesh radio profiles *before* you install and provision the AP as a mesh portal or mesh point. Note that this step is required only if you are configuring a mesh node. For further information on configuring a Mesh network, see ["Secure Enterprise Mesh" on page 439](#)

4. Install the APs by connecting the AP to an Ethernet port on the controller. If the AP does not use Power over Ethernet (PoE) is not used, connect the AP to a power source.
5. On the controller, provision the installed APs.

The following sections explain each of the above steps.

Running the RF Plan

The Java-based RF Plan tool is an application that allows you to determine AP placement based on your specified coverage and capacity requirements without impacting the live network. For more information about using RF Plan, see the *RF Plan Installation and User Guide*.

Verifying that APs Can Connect to the Controller

Before you install APs in a network environment, you must ensure that the APs are able to locate and connect to the controller. Specifically, you must ensure the following:

- When connected to the network, each AP is assigned a valid IP address
- APs are able to locate the controller

 NOTE: In a network with a master and local Dell controllers, an AP will initially connect to the master controller. Alternatively, you can instruct your AP to download its configuration (and ArubaOS) from a local controller (see [Adding Local Controllers on page 664](#) for details).

Configuring Firewall Settings

APs use Trivial File Transfer Protocol (TFTP) during their initial boot to grab their software image and configuration from the controller. After the initial boot, the APs use FTP to grab their software images and configurations from the controller.

In many deployment scenarios, an external firewall is situated between various Dell devices. [External Firewall Configuration on page 507](#) describes the network ports that must be configured on the external firewall to allow proper operation of the network.

Enabling Controller Discovery

An AP can discover the IP address of the controller in the following ways:

- From a DNS server
- From a DHCP server
- Using the Aruba Discovery Protocol (ADP)

At boot time, the AP builds a list of controller IP addresses and then tries these addresses in order until a controller is reached successfully. The list of controller addresses is constructed as follows:

1. If the **master** provisioning parameter is set to a DNS name, that name is resolved and all resulting addresses are put on the list. If **master** is set to an IP address, that address is put on the list.
2. If the **master** provisioning parameter is not set and a controller address was received in DHCP Option 43, that address is put on the list.
3. If the **master** provisioning parameter is not set and no address was received via DHCP option 43, ADP is used to discover a controller address and that address is put on the list.
4. Controller addresses derived from the **server-name** and **server-ip** provisioning parameters and the default controller name **aruba-master** are added to the list. Note that if a DNS name resolves to multiple addresses, all addresses are added to the list.

This list of controller IP addresses provides an enhanced redundancy scheme for Dell controllers that are located in multiple data centers separated across Layer-3 networks.

Configuring DNS Resolution

APs are factory-configured to use the host name **aruba-master** for the master controller. For the DNS server to resolve this host name to the IP address of the master controller, you must configure an entry on the DNS server for the name **aruba-master**.

For information on how to configure a host name entry on the DNS server, refer to the vendor documentation for your server.



NOTE: Dell recommends using a DNS server to provide APs with the IP address of the master controller because it involves minimal changes to the network and provides the greatest flexibility in the placement of APs.

When using DNS, the AP can learn multiple IP addresses to associate with a controller. If the primary controller is unavailable or does not respond, the AP continues through the list of learned IP addresses until it establishes a connection with an available controller. This takes approximately 3.5 minutes per controller.

Configuring DHCP Server Communication with APs

You can configure a DHCP server to provide the master controller's IP address. You must configure the DHCP server to send the controller's IP address using the DHCP vendor-specific attribute option 43. APs identify themselves with a vendor class identifier set to **DellAP** in their DHCP request. When the DHCP server responds to the request, it will send the controller's IP address as the value of option 43.

When using DHCP option 43, the AP accepts only one IP address. If the IP address of the controller provided by DHCP is not available, the AP can use the other IP addresses provisioned or learned by DNS to establish a connection.

For more information on how to configure vendor-specific information on a DHCP server, see [DHCP with Vendor-Specific Options on page 837](#) or refer to the documentation included with your server.

Using the Aruba Discovery Protocol (ADP)

ADP is enabled by default on all Dell APs and Dell controllers. To use ADP, all APs and Dell controllers must be connected to the same Layer-2 network. If the devices are on different networks, a Layer-3 compatible discovery mechanism, such as DNS, DHCP, or IGMP forwarding, must be used instead.

With ADP, APs send out periodic multicast and broadcast queries to locate the master controller. You might need to perform additional network configuration, depending on whether the APs are in the same broadcast domain as the controller:

- If the APs are in the same broadcast domain as the master controller, the controller automatically responds to the APs' queries with its IP address.
- If the APs are not in the same broadcast domain as the master controller, you must enable multicast on the network (ADP multicast queries are sent to the IP multicast group address 239.0.82.11) for the controller to respond to the APs' queries. You also must make sure that all routers are configured to listen for Internet Group Management Protocol (IGMP) join requests from the controller and can route these multicast packets.

To verify that ADP and IGMP join options are enabled on the controller, use the following CLI command:

```
(host) #show adp config
ADP Configuration
-----
key          value
---          -
discovery    enable
igmp-join    enable
```

If ADP or IGMP join options are not enabled, use the following CLI commands:

```
(host) (config) #adp discovery enable
(host) (config) #adp igmp-join enable
```

Verifying that APs Are Receiving IP Addresses

Each AP requires a unique IP address on a subnetwork that has connectivity to a controller. Dell recommends using the Dynamic Host Configuration Protocol (DHCP) to provide IP addresses for APs; the DHCP server can be an existing network server or an controller configured as a DHCP server.

You can use an existing DHCP server in the same subnetwork as the AP to provide the AP with its IP information. You can also configure a device in the same subnetwork to act as a relay agent for a DHCP server on a different subnetwork. (Refer to the vendor documentation for the DHCP Server or relay agent for information.)

If an AP is on the same subnetwork as the master controller, you can configure the controller as a DHCP server to assign an IP address to the AP. The controller must be the only DHCP server for this subnetwork.

In the WebUI

1. Navigate to the **Configuration > Network > IP > DHCP Server** window.
2. Select the **Enable DHCP Server** checkbox.
3. In the Pool Configuration section, click **Add**.
4. Enter information about the subnetwork for which IP addresses are to be assigned. Click **Done**.
5. If there are addresses that should not be assigned in the subnetwork:
 - a. Click **Add** in the Excluded Address Range section.
 - b. Enter the address range in the Add Excluded Address section.
 - c. Click **Done**.
6. Click **Apply** at the bottom of the window.

In the CLI

```
(host) (config) # ip dhcp excluded-address ipaddripaddr2
(host) (config) # ip dhcp pool name
    default-router ipaddr
    dns-server ipaddr
    domain-name name
    network ipaddrmask
(host) (config) # service dhcp
```

Provisioning APs for Mesh

The information in this section applies only if you are configuring and deploying APs in a mesh networking environment. If you are not, proceed to ["Installing APs on the Network" on page 408](#).

Before you install APs in a mesh networking environment, you must do the following:

- Define and configure the mesh cluster profile and mesh radio profile before configuring an AP to operate as a mesh node. An AP configured for mesh is also known as a mesh node.
- Provision one of the following mesh roles on the AP:
 - Mesh portal—The gateway between the wireless mesh network and the enterprise wired LAN.
 - Mesh point—APs that can provide traditional Dell WLAN services (such as client connectivity, intrusion detection system (IDS) capabilities, user roles association, LAN-to-LAN bridging, and Quality of Service (QoS) for LAN-to-mesh communication) to clients on one radio and perform mesh backhaul/network connectivity on the other radio. Mesh points can also provide LAN-to-LAN bridging through their Ethernet interfaces and provide WLAN services on the backhaul radio
 - Remote Mesh Portal: The Remote Mesh Portal feature allows you to configure a remote AP at a branch office to operate as a mesh portal for a mesh cluster.

For detailed provisioning guidelines, caveats, and instructions, see [Secure Enterprise Mesh on page 439](#).





Provisioning 802.11n APs for Single-Chain Transmission

Radios on W-AP92, W-AP120, W-AP124, W-AP134 and W-AP175 Series access points can be configured in single-chain mode, allowing those APs to transmit and receive data using only legacy rates and single-stream HT rates up to MCS 7. This feature is disabled by default.

[Table 116](#) shows the antenna port used by APs in single-chain mode.

Table 116: *Antenna Interfaces for Single-Chain Mode*

AP Model	Frequency Band	Antenna Port
W-AP92	2.4GHz or 5GHz	ANT0 
W-AP120 and W-AP124	2.4Ghz	Upper Left

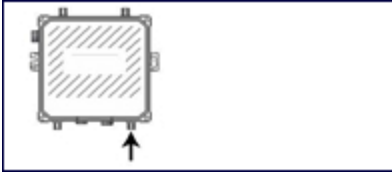
AP Model	Frequency Band	Antenna Port
		
	5GHz	Upper Right 
W-AP134	2.4GHz or 5GHz	ANT0 
W-AP175 Series	2.4GHz	R1-1 
	5GHz	R0-1 

Installing APs on the Network

Use the AP placement map generated by RF Plan to install APs. You can either connect the AP directly to a port on the controller, or connect the AP to another switch or router that has layer-2 or layer-3 connectivity to the controller.

If the Ethernet port on the controller is an 802.3af Power over Ethernet (PoE) port, the AP automatically uses it to power up. If a PoE port is not available, you must get an AC adapter for the AP. For more information, see the Installation Guide for the specific AP.

Once an AP is connected to the network and powered up, it attempts to locate the master controller using one of the methods described in ["Enabling Controller Discovery" on page 405](#).

On the master controller, you can view the APs that have connected to the controller in the WebUI. Navigate to the Configuration > Wireless > AP Installation window. Figure 117 shows an example of this window.

Figure 117: APs Connected to Controller

AP Name	AP Group	AP IP	AP Type	AP MAC Address	AP Serial Number	Status
00:0b:86:cd:cf:d8	default	192.168.10.254	65	00:0b:86:cd:cf:d8	A90008272	Up 3h:33m:18s

Updating the RF Plan

After installing APs, update the AP placement map in RF Plan. This allows more accurate reconciliation of location tracking features provided by the user-centric network—for example, locating users, intruders, rogue APs and other security threats, assets, and sources of RF interference—with the physical environment.

Provisioning Installed APs

The two most common ways to provision an AP for remote authentication are certificate-based AP provisioning and provisioning using a pre-shared key. Although both options allow for a simple secure setup of your remote network, you should make sure that the procedure you select is supported by your controller, the AP model type and the end user's client software. If you must provision your APs using a pre-shared key, you need to know which controller models you have that do not support certificate-based provisioning.

Designation an AP as Remote (RAP) versus Campus (CAP)

Before you provision an AP, you should decide whether you want it to function as a Remote AP (RAP) or a Campus AP (CAP).

- When the network between the AP and controller is an un-trusted/non-routable network, such as the Internet, a RAP is recommended; in cases where the AP needs to connect over private links (LAN, WAN, MPLS), a CAP is recommended. The reason that CAP is not recommended over a non-routable network is because the IPsec within control plane security is in tunnel mode.
- RAP supports internal DHCP server; CAP does not.

For both RAPs and CAPs, tunneled SSIDs will be brought down eight (8) seconds after the AP detects that there is no connectivity to the controller. For CAP bridge-mode SSIDs, the CAP will be brought down after the keepalive times out (default 3.5 minutes). RAP bridge mode SSIDs are configurable to stay up indefinitely (always-on / persistent). Backup mode SSID is supported on the RAP only.

Working with the AP Provisioning Wizard

The easiest way to provision any remote AP is to use the ArubaOS AP Wizard in the WebUI. This wizard will walk you through the specific steps required to provision a remote AP (or any other AP type). To access the AP wizard to provision a remote AP:

1. Select **Configuration > Wizards > AP Wizard**. The Specify Deployment Scenario window appears.
2. Select the **Remote** deployment scenario option.
3. The wizard allows you to configure remote APs to be provisioned by a user at a remote location, or provisioned by a network administrator who will connect those APs directly to the controller as the wizard is being run.
 - Select the **User-Provisioned** option to provision AP models using certificate-based AP provisioning.

- Select the **Administrator-Provisioned** option to provision any AP model authenticated using a Pre-Shared Key (PSK).
4. Click **Next** to continue to the next window in the Wizard. Continue working your way through the wizard to complete the provisioning process.

If you do not want to use the provisioning wizard, you can also define certificate-based and PSK provisioning parameters for a remote AP using the **Configuration > Wireless > AP Installation > Provisioning** window in the WebUI.

Provisioning an Individual AP

The following steps describe the process to provision a AP:

1. If you are provisioning a new AP that has never been provisioned before, connect the AP to the controller according the instructions included with that AP. If you are reprovisioning existing active APs as remote APs, this step is not necessary, as the APs are already communicating with the controller.
2. Navigate to the **Configuration > Wireless > AP Installation > Provisioning** window.
3. Click the checkbox by the AP you want to provision, then click **Provision**. The Provisioning window opens.

Figure 118: AP Provisioning Window

Wireless > AP Installation > Provision

Provisioning | Provisioning Profile | Whitelist

AP Parameters
 AP Group: default

AP Installation Mode
 Default Indoor Outdoor

Antenna Parameters
Antenna Selection
 Internal/Included Antenna External Antenna

Authentication Method
Remote AP Yes No
Remote AP Authentication Method Pre-shared Key Certificate
 IKE PSK: _____ Confirm IKE PSK: _____

User credential assignment Use Automatic Generation
 Global User Name/Password per AP User Name/Password
 User Name: _____ Password: _____ Confirm Password: _____
 Password: _____ Confirm Password: _____

PPPoE Parameters
 Service Name: _____ User Name: _____ Password: _____ Confirm Password: _____
 CHAP Secret: _____ Confirm CHAP Secret: _____

802.1x Parameters using PEAP
 User Name: _____ Password: _____ Confirm Password: _____

Master Discovery
 Use AP Discovery Protocol
 Host Controller IP Address: 10.4.62.9 Master Controller IP Address/DNS name: 10.4.62.9
 Host Controller Name: _____ Master Controller IP Address/DNS name: _____

IP Settings
 Uplink Vlan: 0
 Obtain IP Address Using DHCP
 Use the following IP Address
 IP Address: _____ Subnet Mask: _____
 Gateway IP Address: _____ Domain Name: _____
 DNS IP Address: _____
 IPv6 Address/Prefix-length: _____
 Gateway IPv6 Address: _____
 DNS IPv6 Address: _____

FQLN Mapper
 Remove FQLN:
 Campus: N/A Building: N/A Floor: N/A

Single Chain Mode
 Enable for Radio-0: Enable for Radio-1:

AP List

AP IP Address	AP Name	AP Group	SNMP System Location	Mesh Role	AP Type	Serial Number
10.4.62.242	00:24:6c:c0:0c:da	default		none	105	AL0003134

Apply and Reboot | Cancel

- In the **AP Parameters** section, click the **AP Group** drop-down list and select the AP group to which this AP should be assigned.
- (Optional) Some AP models support an external antenna in addition to their internal antenna. If the AP you are provisioning supports an external antenna, the Provisioning window displays an additional **Antenna Parameters** section. If you want to use an External antenna for the remote AP you are provisioning, select **External Antenna** and define settings for that antenna. Otherwise, the remote AP will use its internal antenna by default.
- If you are provisioning a remote AP, select **Yes** for the **Remote AP** option.
- (For Remote APs only) In the **Remote IP Authentication Method** section, select either **Pre-shared key** or **certificate** authentication type.

Certificate based authentication allows a controller to authenticate a AP using its certificates instead of a PSK. You can manually provision an individual AP with a full set of provisioning parameters, or simultaneously provision an entire group of APs by defining a provisioning profile which contains a smaller set of provisioning parameters that can be applied the entire AP group. When you manually provision an individual AP to use certificated-based authentication, you must connect that AP to the controller before you can define its provisioning settings.

Use **Pre-Shared Key (PSK) authentication** to provision an individual remote AP or a group of remote APs using an Internet Key Exchange Pre-Shared Key (IKE PSK). This option requires you to perform the following additional steps:

- a. Enter and confirm the pre-shared key (IKE PSK).
 - b. In the User credential assignment section, specify if you want to use a **Global User Name/password** or a **Per AP User Name/Password**.
 - If you use the Per AP User Names/Passwords option, each RAP is given its own user name and password. I
 - If you use the Global User Name/Password option, all selected RAPs are given the same (shared) user name and password.
 - c. Enter the user name, and enter and confirm the password. If you want the controller to automatically generate a user name and password, select **Use Automatic Generation**, then click **Generate** by the **User Name** and **Password** fields.
8. (Optional) If your AP will use Point-to-Point Protocol over Ethernet (PPPoE) to authenticate itself to a service provider, select the **PPPoE Parameters** checkbox and enter the following PPPoE values:
 - Service Name: Either an ISP name or a class of service configured on the PPPoE server.
 - User Name: Set the PPPoE User Name for this remote AP.
 - Password: Enter and then confirm the PPPoE password for this remote AP.
 9. In the **Master Discovery** section, set the Master IP Address.
 - For a campus AP or a remote AP on a private network, enter the controller's IP address
 - For a Remote AP with the controller on a public network, enter the controller's public IP address
 - For a remote AP with a controller behind a firewall, enter the public address of the NAT device to which the controller is connected
 10. (Optional) In the **IP Settings** section, specify a trunk VLAN by entering a VLAN ID from 1-4095, inclusive. If you configure an uplink VLAN on an AP connected to a port in trunk mode, the AP sends and receives frames tagged with this VLAN on its Ethernet uplink.

By default, an AP has an uplink vlan of 0, which disables this feature. Note that if an AP is provisioned with an uplink VLAN, it must be connected to a trunk mode port or the AP's frames will be dropped.
 11. Under IP Settings, select **Obtain IP Address Using DHCP** to obtain an IP address for your AP using DHCP.

or

select **Use the Following IP address** and enter the appropriate values in the following fields:

 - **IP address:** IP address for the AP, in dotted-decimal format
 - **Subnet mask:** Subnet mask for the IP, in dotted-decimal format.
 - **Gateway IP address:** The IP address the AP uses to reach other networks.
 - **DNS IP address:** The IP address of the Domain Name Server.
 - **Domain name:** (optional) The default domain name.
 12. (Optional) In the FQLN Mapper section, you may click the **Campus**, **Building** and **Floor** drop-down lists to identify a fully qualified location name (FQLN) for the AP. To clear an existing FQLN, click the **Remove FQLN** checkbox.

13. (Optional) If you are provisioning an 802.11n-capable AP, select the **Enable for Radio-0** or **Enable for Radio-1** checkboxes in the **Single-Chain Mode** section to enable single-chain mode for the selected radio. AP radios in single-chain mode will transmit and receive data using only legacy rates and single-stream HT rates up to MCS 7. This feature is disabled by default.
14. The **AP list** section displays current information for the AP you are provisioning or reprovisioning, and allows you to define additional parameters for your remote AP, such as AP Name, SNMP System Location and (if you are provisioning a Mesh Point or Portal) the AP's Mesh role.
15. Click **Apply and Reboot**. (Reprovisioning the AP causes it to automatically reboot).

Provisioning Multiple APs using a Provisioning Profile

When you create a provisioning profile, you can then apply that profile to an AP group and provision that entire group of campus or remote APs with the settings in that profile.

By default, an AP group does not have a provisioning profile. Make sure that any provisioning profiles you create are complete and accurate before you assign that profile to an AP group. If a misconfigured provisioning profile is assigned to a group of APs, the APs in that group may be automatically provisioned with erroneous parameters and become lost.

1. Navigate to the **Configuration > Wireless > AP Installation > Provisioning** window.
2. Next, select the **Provisioning Profile** tab and enter a provisioning profile name in the text box (next to the Add button).
3. Click the **Add** button to add the profile name.
4. Select your new provisioning profile name from the list at the left.
5. (Optional) If you are provisioning a remote AP, select the **Remote-AP** checkbox.
6. Enter the IP address or the fully qualified domain name of the master controller in the **Master IP/FQDN** field.
7. If your AP will use Point-to-Point Protocol over Ethernet (PPPoE) to authenticate itself to a service provider, select the **PPPoE Parameters** checkbox and enter the following PPPoE values:
 - PPPoE User Name: Set the PPPoE User Name for this remote AP.
 - PPPoE Password: Enter and then confirm the PPPoE password for this remote AP.
 - PPPoE Service Name: Either an ISP name or a class of service configured on the PPPoE server.
8. (Optional) If you want to use this provisioning profile to provision APs with more than one interface, you must also configure the USB settings and priority levels for this profile. The configuration settings in this profile are described in [Table 119](#).
9. Click **Apply** to save your settings.

Table 119: AP Provisioning Profile parameters

Parameter	Description
Remote-AP	Select this checkbox to provision the group of APs as remote APs.
Master IP/FQDN	The fully qualified domain name (FQDN) or IP address of the controller to which the AP is associated. NOTE: If you configure a master IP/FQDN setting in an AP's provisioning profile, this setting will override any LMS and backup LMS settings configured in an AP's AP system-profile. Leave the master IP/FQDN parameter blank if you want the AP to use the LMS or backup LMS values.
PPPOE User Name :	Point-to-Point Protocol over Ethernet (PPPoE) password for the AP.

Parameter	Description
PPPOE Password :	Point-to-Point Protocol over Ethernet (PPPoE) password for the AP.
PPPOE Service Name	Configures the PPPoE service name for the AP.
USB User Name	Configures the PPPoE username for the AP.
USB Password :	A PPP password, if provided by the cellular service provider.
USB Device Type	The USB device type.
USB Device Identifier	The USB device identifier.
USB Dial String	The dial string for the USB modem. This parameter only needs to be specified if the default string is not correct.
USB Initialization String	The initialization string for the USB modem. This parameter only needs to be specified if the default string is not correct.
USB TTY device data path	The TTY device path for the USB modem. This parameter only needs to be specified if the default path is not correct.
USB TTY device control path	The TTY device control path for the USB modem. This parameter only needs to be specified if the default path is not correct.
Link Priority Ethernet	Set the priority of the wired uplink. Each uplink type has an associated priority; wired ports having the highest priority by default.
Link Priority Cellular	Set the priority of the cellular uplink. By default, the cellular uplink is a lower priority than the wired uplink; making the wired link the primary link and the cellular link the secondary or backup link. Configuring the cellular link with a higher priority than your wired link priority will set your cellular link as the primary controller link.
Username of AP so that AP can authenticate to 802.1x using PEAP	Configure the AP username.
Password of AP so that AP can authenticate to 802.1x using PEAP	Configure the AP password.
Uplink VLAN	If you configure an uplink VLAN on an AP connected to a port in trunk mode, the AP sends and receives frames tagged with this VLAN on its Ethernet uplink. By default, an AP has an uplink vlan of 0, which disables this feature. If an AP is provisioned with an uplink VLAN, it must be connected to a trunk mode port or the AP's frames will be dropped. 0 (disabled) to 4095 0

Assigning Provisioning Profiles

Once you have defined a provisioning profile, you must assign that profile to an AP group.

1. Navigate to the **Configuration > AP configuration** window and select the **AP group** tab.
2. Click the **Edit** button by the name of the AP group to which you want to assign the provisioning profile.
3. In the profiles list, expand the **AP** menu, and select **Provisioning Profile**. The Profile Details window appears.
4. Click the **Provisioning Profile** drop-down list and select the name of the provisioning profile you want to assign to this AP group.
5. Click **Apply**.

If you are provisioning remote APs, you must also add the remote APs to the RAP whitelist. For details, see ["Remote Access Points" on page 510](#).

Troubleshooting

After the AP has been provisioned, navigate to **Monitoring>All Access Points** window and verify that the AP has an **up** status. The AP on your network *does not* appear in this table, it may have been classified as an inactive AP for any of the following reasons:

- The AP is configured with a missing or incorrect VLAN. (For example, the AP is configured to use a tunneled SSID of VLAN 2 but the controller doesn't have a VLAN 2.)
- The AP has an unknown AP group.
- The AP has a duplicate AP name.
- An AP with an external antenna is not provisioned with external antenna gain settings.
- Both radios on the AP are disabled.
- No virtual APs are defined on the AP.
- The AP has profile errors. For details, access the command-line interface and issue the command “show profile errors”.
- The GRE tunnel between the AP and the controller was blocked by a firewall after the AP became active.
- The AP is temporarily down while it is upgrading its software. The AP will become active again after upgrading.

Configuring a Provisioned AP

Once the AP has been installed and provisioned, you can use the WebUI or CLI to configure the optional AP settings described in the following sections:

- ["AP Installation Modes" on page 415](#)
- ["Renaming an AP" on page 416](#)
- ["Optimize APs Over Low-Speed Links" on page 417](#)
- ["AP Redundancy" on page 421](#)
- ["AP Maintenance Mode " on page 421](#)
- ["Energy Efficient Ethernet" on page 422](#)
- ["Managing AP LEDs" on page 423](#)

AP Installation Modes

By default, all AP models initially ship with an indoor or outdoor installation mode. This means that APs with an indoor installation mode are normally placed in enclosed, protected environments and those with an outdoor installation mode are used in outdoor environments and exposed to harsh elements.

In most countries, there are different channels and power that are allowed for indoor and outdoor operation. You may want to change an AP's installation mode from indoor to outdoor or vice versa.

Using the WebUI

To configure the installation mode for an AP, follow these steps:

1. Navigate to the **Configuration > Wireless > AP Installation** page. The list of discovered APs are displayed on this page.
2. Select the AP you want to change.
3. Click **Provision** to reveal the **Provisioning** page.

Locate the **AP Installation Mode** section. By default, the **Default** mode is selected. This means that the AP installation type is based on the AP model.

4. Select the **Indoor** option to change the installation to Indoor mode. Select the **Outdoor** option to change the to Outdoor mode.
5. Click **Apply and Reboot** (at the bottom of the page).

Using the CLI

This example displays the AP installation mode options and sets the AP to indoor installation mode.

```
(host) (config) #provision-ap
(host) (AP provisioning) #installation ?
  default          Decide by AP model
  indoor           Indoor installation
  outdoor          Outdoor installation
(host) (AP provisioning) #installation indoor
```

This example shows basic information details about the configuration of an AP named “MyAP.” The AP installation mode is indoor.

```
(host) #show ap details ap-name myAP
```

```
AP "MyAP" Basic Information
```

```
-----
Item          Value
----          -
AP IP Address 10.0.0.253
LMS IP Address 10.0.0.1
Group         default
Location Name N/A
Status        Up; Mesh
Up time       9m:55s
Installation  indoor
```

Renaming an AP

You can display the status of APs in your database by executing the `show ap database long` command. The output will flag an AP that has a duplicate name (N flag).

To clear the AP with the duplicate name (assuming it is no longer connected to your network), use the command `clear gap-db wired-mac`.

Using the WebUI

1. Navigate to the **Configuration > Wireless > AP Installation** page. A list of discovered APs are on this page.
2. Select the AP you want to rename, and click **Provision**.
3. On the Provisioning page, scroll to the AP list at the bottom of the page and find the AP you want to rename.
4. In the AP Name field, enter the new unique name for the AP.
5. Click **Apply and Reboot**.

Using the CLI

Execute the following command (from enable mode) only on a master controller. Executing the command causes the AP to automatically reboot.

```
ap-rename {ap-name <name>|serial-num <number>|wired-mac <macaddr>} <new-name>
```

If an AP is recognized by the controller but is powered off or not connected to the network or controller when you execute the command, the request is queued until the AP is powered back on or reconnected.

Optimize APs Over Low-Speed Links

Depending on your deployment scenario, you may have APs or remote APs that connect to a controller located across low-speed (less than 1 Mbps capacity) or high-latency (greater than 100 ms) links.

With low-speed links, if heartbeat or keep alive packets are not received between the AP and controller during the defined interval, APs may reboot causing clients to re-associate. You can adjust the bootstrap threshold and prioritize AP heartbeats to optimize these types of links. In addition, high bandwidth applications may saturate low-speed links. For example, if you have tunnel-mode SSIDs, use them with low-bandwidth applications such as barcode scanning, small database lookups, and Telnet to avoid saturating the link. If you have traffic that will remain local, deploying remote APs and configuring SSIDs as bridge-mode SSIDs can also prevent link saturation.

With high-latency links, consider the amount and type of client devices accessing the links. Dell APs locally process 802.11 probe-requests and probe-responses, but the 802.11 association process requires interaction with the controller.

When deploying APs across low-speed or high-latency links, Dell recommends the following best practices:

- Connect APs and Dell controllers over a link with a capacity of 1 Mbps or greater.
- Maintain a minimum link speed of 64 Kbps per GRE tunnel and per bridge-mode SSID. This is the minimum speed required for downloading software images.
- Adjust the bootstrap threshold to 30 if the network experiences packet loss. This makes the AP recover more slowly in the event of a failure, but it will be more tolerant to heartbeat packet loss.
- Prioritize AP heartbeats to prevent losing connectivity with the controller.
- If possible, reduce the number of tunnel-mode SSIDs. Each SSID creates a tunnel to the controller with its own tunnel keep alive traffic.
- If most of the data traffic will remain local to the site, deploy remote APs in bridging mode. For more information about remote APs, see [Access Points \(APs\) on page 393](#).
- If high-latency links such as transoceanic or satellite links are used in the network, deploy a controller geographically close to the APs.
- If high-latency causes association issues with certain handheld devices or barcode scanners, check the manufacturer of the device for recent firmware and driver updates.

Configuring the Bootstrap Threshold

To configure the bootstrap threshold using the WebUI:

1. Navigate to the **Configuration > Wireless > AP Configuration** page.

2. Select either the **AP Group** or **AP Specific** tab. Click **Edit** by the AP group or AP name.

The AP system profile configuration settings are divided into two tabs, **Basic** and **Advanced**. The **Basic** tab displays only those configuration settings that often need to be adjusted to suit a specific network. The **Advanced** tab shows all configuration settings, including settings that do not need frequent adjustment or should be kept at their default values. If you change a setting on one tab then click and display the other tab without saving your configuration, that setting will revert to its previous value. Both basic and advanced settings are described in [Table 120](#).

3. Under Profiles, select **AP**, then **AP system profile**. The profile appears the **Profile Details** window.

4. In the **Bootstrap threshold** field, enter 30.

5. Click **Apply**.

Table 120: AP System Profile Configuration

Parameter	Description
Basic AP System Profile Settings—General	
RF Band	For APs that support both 802.11a and 802.11b/g RF bands, specify the RF band in which the AP should operate: <ul style="list-style-type: none"> g = 2.4 GHz a = 5 GHz
RF Band for AM Mode scanning	For Air Monitors that support both 802.11a and 802.11b/g RF bands, specify the RF band which the AM should scan: <ul style="list-style-type: none"> a = 5 GHz all = both radio bands g = 2.4 GHz
Native VLAN ID	Native VLAN for bridge mode virtual APs (frames on the native VLAN are not tagged with 802.1q tags).
Session ACL	Session ACL configured with the ip access-list session command. NOTE: This parameter requires the PEFNG license.
Corporate DNS Domain	Name of domain that is resolved by corporate DNS servers. Use this parameter when configuring split-tunnel forwarding.
SNMP sysContact	SNMP system contact information.
LED operating mode	The operating mode for the 802.11n-capable AP LEDs.
Basic AP System Profile Settings—LMS	
SAP MTU	Maximum Transmission Unit, in bytes, on the wired link for the AP.
LMS IP	In multi-controller networks, this parameter specifies the IP address of the local management switch (LMS)—the Dell controller—which is responsible for terminating user traffic from the APs, and processing and forwarding the traffic to the wired network. This can be the IP address of the local or master controller. When using redundant controllers as the LMS, set this parameter to be the VRRP IP address to ensure that APs always have an active IP address with which to terminate sessions. NOTE: If the LMS-IP is blank, the access point will remain on the controller that it finds using methods like DNS or DHCP. If an IP address is configured for the LMS IP parameter, the AP will be immediately redirected to the controller at that address.
Backup LMS IP	In multi-controller networks, specifies the IP address of a <i>backup</i> to the IP address specified with the lms-ip parameter.
LMS IPv6	
Backup LMS IPv6	
LMS Preemption	When this parameter is enabled, the AP automatically reverts to the primary LMS IP address when it becomes available.
Basic AP System Profile Settings—Remote AP	
LMS Hold-down Period	Time, in seconds, that the primary LMS must be available before an AP returns to

Parameter	Description
	that LMS after failover.
Remote-AP DHCP Server VLAN	VLAN ID of the remote AP DHCP server used if the controller is unavailable. This VLAN enables the DHCP server on the AP (also known as the remote AP DHCP server VLAN). If you enter the native VLAN ID, the DHCP server is unavailable.
Remote-AP DHCP Server Id	IP address used as the DHCP server identifier.
Remote-AP DHCP Default Router	IP address for the default DHCP router.
Remote-AP DHCP DNS Server	IP address of the DNS server.
Remote-AP DHCP Pool Start	Configures a DHCP pool for remote APs. This is the first IP address of the DHCP pool.
Remote-AP DHCP Pool End	Configures a DHCP pool for remote APs. This is the last IP address of the DHCP pool.
Remote-AP DHCP Pool Netmask	Configures a DHCP pool for remote APs. This is the netmask used for the DHCP pool.
Remote-AP DHCP Lease Time	The amount of days that the assigned IP address is valid for the client. Specify the lease in <days>. A value of 0 indicates the IP address is always valid; the lease does not expire.
Remote-AP uplink total bandwidth	This is the total reserved uplink bandwidth (in Kilobits per second).
Remote-AP bw reservation 1 Remote-AP bw reservation 2 Remote-AP bw reservation 3	Session ACLs with uplink bandwidth reservation in kilobits per second. You can specify up to three session ACLs to reserve uplink bandwidth. The sum of the three uplink bandwidths should not exceed the Remote-AP uplink total bandwidth .
Remote-AP Local Network Access	Enable or disable local network access across VLANs in a Remote-AP.
Advanced AP System Profile Settings	
Bootstrap threshold	Number of consecutive missed heartbeats on a GRE tunnel (heartbeats are sent once per second on each tunnel) before an AP reboots. On the controller, the GRE tunnel timeout is 1.5 x bootstrap-threshold; the tunnel is torn down after this number of seconds of inactivity on the tunnel. The supported range is 1-65535, and the default value is 8.
Double Encrypt	This parameter applies only to remote APs. Use double encryption for traffic to and from a wireless client that is connected to a tunneled SSID. When enabled, all traffic is re-encrypted in the IPsec tunnel. When disabled, the wireless frame is only encapsulated inside the IPsec tunnel. All other types of data traffic between the controller and the AP (wired traffic and traffic from a split-tunneled SSID) are always encrypted in the IPsec tunnel.
Dump Server	(For debugging purposes.) Specifies the server to receive a core dump generated when an AP process crashes.
Heartbeat DSCP	Assign a DSCP value to AP heartbeats to prioritize heartbeats traveling over low-speed links. The supported range is 0-63, and the default value is 0. For more information, see "Prioritizing AP heartbeats " on page 420.
Maintenance Mode	Enable or disable AP maintenance mode. This setting is useful when deploying, maintaining, or upgrading the network. If enabled, APs stop flooding unnecessary traps and syslog messages to network management systems or network operations centers when deploying, maintaining, or

Parameter	Description
	upgrading the network. The controller still generates debug syslog messages if debug logging is enabled.
Number of IPSEC retries	Number of times the AP will try to create an IPsec tunnel with the master controller before the AP will reboot. If you specify a value of 0, and AP will not reboot if it cannot create the IPsec tunnel. The supported range of values is 0-1000 retries, and the default value is 360 retries.
Maximum Request Retries	Maximum number of times to retry AP-generated requests, including keepalive messages. After the maximum number of retries, the AP either tries the IP address specified by the bkup-lms-ip (if configured) or reboots.
Request Retry Interval	Interval, in seconds, between the first and second retries of AP-generated requests. If the configured interval is less than 30 seconds, the interval for subsequent retries is increased up to 30 seconds.
Root AP	Defines a remote AP as the root AP in a branch office network with a multi-AP hierarchy.
AeroScout RTLS Server	Enables the AP to send AeroScout tag information to an RTLS server. You must specify the IP address and port number of the server to which location reports are sent.
RTLS Server configuration	Enables the AP to send RFID tag information to an RTLS server. You must specify the IP address and port number of the server to which location reports are sent, a shared secret key, and the frequency at which packets are sent to the server.
Telnet	Select this checkbox to enable telnet to the AP.

To configure the bootstrap threshold using the command-line interface, access the CLI in config mode and issue the following command:

```
ap system-profile <profile>
  bootstrap-threshold 30
```

Prioritizing AP heartbeats

If the AP heartbeat or keep alive packets sent between the APs and controller are not received during the defined interval, the APs may reboot, causing clients to re-associate. If a high-latency or low-speed link prevents AP heartbeats from being sent and received correctly, you can assign a DSCP value to AP heartbeats to prioritize the heartbeats.

To prioritize AP heartbeats using the WebUI:

1. Navigate to the **Configuration > Wireless > AP Configuration** page.
2. Select either the AP Group or AP Specific tab. Click **Edit** for the AP group or AP name.
3. Under Profiles, select **AP**, then **AP system profile**. The configuration settings are displayed in Profile Details.
4. Under Profile Details:
 - a. In the **Heartbeat DSCP** field, enter a value greater than zero.
 - b. Click **Apply**.

To prioritize AP heartbeats using the command-line interface, access the CLI in config mode and issue the following command:

```
ap system-profile <profile>
  heartbeat-dscp <number>
```

AP Redundancy

In conjunction with the controller redundancy features described in [VRRP on page 477](#) the information in this section describes redundancy for APs. Remote APs also offer redundancy solutions via a backup configuration, backup controller list, and remote AP failback. For more information relevant to remote APs, see [Remote Access Points on page 510](#).

The AP failback feature allows an AP associated with the backup controller (backup LMS) to fail back to the primary controller (primary LMS) if it becomes available.

If configured, the AP monitors the primary controller by sending probes every 600 seconds by default. If the AP successfully contacts the primary controller for the entire hold-down period, it will fail back to the primary controller. If the AP is unsuccessful, the AP maintains its connection to the backup controller, restarts the LMS hold-down timer, and continues monitoring the primary controller.

The following example assumes:

- You have not configured the LMS or backup LMS IP addresses
- Default values unless otherwise noted.

Using the WebUI

Follow the procedure below to use the AP system profile to configure a redundant controller. For additional information on AP system profile settings, see [Table 120](#).

1. Navigate to the **Configuration > Wireless > AP Configuration** page.
2. Select either the AP Group or AP Specific tab. Click **Edit** for the AP group or AP name.
3. Under Profiles, select **AP** to display the AP profiles.
4. Select the AP system profile you want to modify.
5. Under Profile Details:
 - a. At the **LMS IP** field, enter the primary controller IP address.
 - b. At the **Backup LMS IP** field, enter the backup controller IP address.
 - c. Click (select) **LMS Preemption**. This is disabled by default.
6. Click **Apply**.

Using the CLI

```
ap system-profile <profile>
  lms-ip <ipaddr>
  bkup-lms-ip <ipaddr>
  lms-preemption

ap-group <group>
  ap-system-profile <profile>

ap-name <name>
  ap-system-profile <profile>
```

AP Maintenance Mode

You can configure APs to suppress traps and syslog messages related to those APs. Known as AP maintenance mode, this setting in the AP system profile is particularly useful when deploying, maintaining, or upgrading the network. If enabled, APs stop flooding unnecessary traps and syslog messages to network management systems or network operations centers during a deployment or scheduled maintenance. The controller still generates debug syslog messages if debug logging is enabled. After completing the network maintenance, disable AP maintenance mode to ensure all traps and syslog messages are sent. AP maintenance mode is disabled by default.

Using the WebUI

1. Navigate to the **Configuration > Wireless > AP Configuration** page.
2. Select either the AP Group or AP Specific tab. Click **Edit** for the AP group or AP name.
3. Under Profiles, select **AP** to display the AP profiles.
4. Select the AP system profile you want to modify.
5. Under Profile Details, do the following:
 - To enable AP maintenance mode, check (select) the **Maintenance Mode** checkbox.
 - To disable AP maintenance mode, clear (deselect) the **Maintenance Mode** checkbox.
6. Click **Apply**.

Using the CLI

To enable AP maintenance mode:

```
ap system-profile <profile>
  maintenance-mode
To disable AP maintenance mode:
ap system-profile <profile>
  no maintenance-mode
```

To view the maintenance mode status of APs, use the following commands:

```
show ap config {ap-group <name>|ap-name <name>|ssid <name>}
show ap debug system-status {ap-name <name>|bssid <name>| ip-addr <ipaddr>}
```

On the local controller, you can also view maintenance mode status using the following commands:

```
show ap active {ap-name <name>|ssid <name>|ip-addr <ipaddr>}
show ap database
show ap details {ap-name <name>|bssid <name>|ip-addr <ipaddr>}
```

Energy Efficient Ethernet

The W-AP130 Series support the 803.az Energy Efficient Ethernet (EEE) standard, which allows the APs to consume less power during periods of low data activity. This setting can be enabled for provisioned APs or AP groups through the Ethernet Link profile. If this feature is enabled for an APs group, any APs in the group that do not support 803.az will ignore this setting.

Using the WebUI

1. Navigate to the **Configuration > Advanced Services > All Profiles** page.
2. In the **Profiles** list, select **AP** to expand the AP profile menu.
3. Select **AP Ethernet Interface Link** profile. The list of existing Ethernet Link profiles appears in the **Profile Details** window. Select the Ethernet link profile you want to configure to support 803.az from this list, or create a new Ethernet link profile by entering a name for the new profile, then clicking **Add**.
4. The selected profile appears in the **Profile Details** window. The configuration parameters for the profile are described in

Table 121: Ethernet Interface Link Profile Parameters

Parameter	Description
Speed	The speed of the Ethernet interface, either 10 Mbps, 100 Mbps, 1000 Mbps (1 Gbps), or auto-negotiated.

Parameter	Description
Duplex	The duplex mode of the Ethernet interface, either full, half, or auto-negotiated.
802.3az (EEE)	Select this checkbox to enable support for 802.1az Energy Efficient Ethernet. (for W-AP130 Series only).

5. [Table 121](#).

6. Select the 803.az checkbox.

7. Click **Apply** to save your changes.

By default, AP wired port profiles reference the Default Ethernet interface link profile. If you created a new Ethernet interface link profile to support 803.az, use the procedure below to associate a AP wired port profile or Ethernet interface port configuration with the new Ethernet Interface link profile.

To associate a new Ethernet interface link profile with a wired port profile:

1. Navigate to the **Configuration > Advanced Services > All Profiles** page.
2. In the **Profiles** list, select **AP** to expand the **AP profile** menu.
3. Select **AP Wired Port Profile** to display a list of existing wired port profiles
4. Select the AP wired port profile you want to support 802.az. The Ethernet interface link profile currently associated with the port profile appears below the port profile in the **Profiles** list.
5. Click the Ethernet interface link profile currently associated with the AP wired port profile you want to modify. The settings for the Ethernet interface link profile appear in the **Profile Details** window.
6. Click the **Ethernet interface link profile** drop-down list at the top of the **Profile Details** window, and select a new Ethernet interface link profile.
7. Click **Apply** to save your changes.

Using the CLI

To enable support for 803.az EEE, access the command-line interface in config mode and issue the following command:

```
ap enet-link-profile <profile> dot3az
```

Associate a new Ethernet Interface link profile with an AP wired port profile using the following command:

```
ap wired-port-profile <profile>
    enet-link-profile <profile>
```

Managing AP LEDs

AP LEDs can be configured in two modes: **normal** and **off**. In normal mode, the AP LEDs will light as expected. When the mode is set to off, all of the LEDs on the affected APs are disabled.

Using the WebUI

An AP system profile's LED operating mode affects LEDs on all APs using that profile.



NOTE: This option is available on the W-AP120 Series, W-AP90 Series, and W-AP105.

1. Navigate to the **Configuration > Advanced Services > All Profiles** page.
2. Select the AP tab and then select the **AP system profiles** tab.
3. Select the AP system profile you want to modify.

4. Locate the **LED operating mode** parameter.
5. From the drop-down list, select **off**.
6. Click **Apply**.

Using the CLI

Use the **ap system-profile** command to disable LEDs for all APs using a particular system profile.

```
(host) (config)# ap system-profile <profile-name> led-mode {normal | off}
```

Use the **ap-leds** command to make the LEDs on a defined set of APs either blink or display in the currently configured LED operating mode. Note that if the LED operating mode defined in the AP's system profile is set to "off", then the **normal** parameter in the **ap-leds** command will disable the LEDs. If the LED operating mode in the AP system profile is set to "normal" then the **normal** parameter in this command will allow the LEDs light as usual.

```
(host) (config)# ap-leds {all | ap-group <ap-group> | ap-name <ap-name> | ip-addr <ip address> | wired-mac <mac address>} {global blink|normal}|{local blink|normal}
```

RF Management

802.11a and 802.11g RF Management Profiles

The two 802.11a and 802.11g RF management profiles for an AP configure its 802.11a (5 GHz) and 802.11b/g (2.4 GHz) radio settings. You can either use the "default" version of each profile, or create a new 802.11a or 802.11g profile using the procedures below. Each RF management radio profile includes a reference to an Adaptive Radio Management (ARM) profile. If you would like the ARM feature to dynamically select the best channel and transmission power for the radio, verify that the RF management profile references an active and enabled ARM profile. It can be useful to set the **Max Tx EIRP** parameter in the ARM profile to 127 (the maximum power level permissible) until it determines the signal-to-noise ratio on the links. If ARM is active, the **Max Tx EIRP** can also be set to 127 to allow maximum power levels.

If you want to manually select a channel for each AP group, create separate 802.11a and 802.11g profiles for each AP group and assign a different transmission channel for each profile. For example, one AP group could have an 802.11a profile that uses channel 36 and an 802.11g profile that uses channel 11, and another AP group could have an 802.11a profile that uses channel 40 and an 802.11g profile that uses channel 9.

With the implementation of the high-throughput IEEE 802.11n standard, 40 MHz channels were added in addition to the existing 20 MHz channel options. Available 20 MHz and 40 MHz channels are dependent on the country code entered in the regulatory domain profile.



NOTE: Changing the country code causes the valid channel lists to be reset to the defaults for the country.

The following channel configurations are available in ArubaOS:

- A 20 MHz channel assignment consists of a single 20 MHz channel. This channel assignment is valid for 802.11a/b/g and for 802.11n 20 MHz mode of operation.
- A 40 MHz channel assignment consists of two 20 MHz channels bonded together (a bonded pair). This channel assignment is valid for 802.11n 40 MHz mode of operation and is most often utilized on the 5 GHz frequency band.

If high-throughput is disabled, a 40 MHz channel assignment can be configured, but only the primary channel assignment is utilized. The 20 MHz clients can also associate using this configuration, but only the primary channel is utilized.

Managing 802.11a/802.11g Profiles Using the WebUI

Use the following procedures to define and manage 802.11a and 802.11g RF management profiles Using the WebUI.

Creating or Editing a Profile

1. Navigate to the **Configuration > Wireless > AP Configuration** window. Select either the **AP Group** or **AP Specific** tab.
 - If you selected **AP Group**, click the **Edit** button by the AP group for which you want to create or change an RF management profile.
 - If you selected **AP Specific**, click the **Edit** button by the AP for which you want to create or change an RF management profile.
2. In the Profiles list, expand the **RF Management** menu, then select either **802.11a radio profile** or **802.11g radio profile**.
3. To edit an existing 802.11a or 802.11g radio profile, select the desired profile from the **802.11a radio profile** or **802.11g radio profile** drop-down list at the top of the **Profile Details** window-or-To create a new 802.11a or 802.11g profile, click the drop-down list at the top of the

Profile Details window, select **NEW**, then enter a name for the new profile.

The 802.11a and 802.11g profiles are divided into two tabs, **Basic** and **Advanced**. The **Basic** tab displays only those configuration settings that often need to be adjusted to suit a specific network. The **Advanced** tab shows all configuration settings, including settings that do not need frequent adjustment or should be kept at their default values. If you change a setting on one tab then click and display the other tab without saving your configuration, that setting will revert to its previous value. The basic and advanced profile settings are described in [Table 122](#).

4. Make the desired configuration changes, then click **Apply** to save your settings.

Table 122: 802.11a/802.11g RF Management Configuration Parameters

Parameter	Description
Basic 802.11a/802.11g Settings – General	
Radio Enable	Enable transmissions on this radio band.
Mode	Access Point operating mode. Available options are: <ul style="list-style-type: none">• am-mode: Air Monitor mode• ap-mode: Access Point mode• spectrum-mode: Spectrum Monitor mode The default settings is ap-mode .
Transmit EIRP	Maximum transmit EIRP in dBm from 0 to 51 in .5 dBm increments, or 127 for regulatory maximum. Transmit power may be further limited by regulatory domain constraints and AP capabilities.
Enable CSA	Channel Switch Announcements (CSAs), as defined by IEEE 802.11h, enable an AP to announce that it is switching to a new channel before it begins transmitting on that channel. This allows clients that support CSA to transition to the new channel with minimal downtime.
TPC power	The transmit power advertised in the TPC IE of beacons and probe responses. The supported range is 0-51 dBm, and the default value is 15 dBm.
High throughput enable (Radio)	Enable/Disable high-throughput (802.11n) features on the radio. This option is enabled by default.

Parameter	Description
Channel	<p>Transmit channel for this radio. The available channels depend on the regulatory domain (country). This parameter includes the following channel number configuration options for 20 MHz and 40 MHz modes:</p> <ul style="list-style-type: none"> ● none: Select this option to disable 40 MHz mode and activate 20 MHz mode for the entered channel. ● above: Entering a channel number and selecting the above radio button in the WebUI selects a primary and secondary channel for 40 MHz mode. When you use this option, the number entered becomes the primary channel and the secondary channel is determined by increasing the primary channel number by 4. For example, if you entered 157 into the Channel field and selected the above option, radios using that profile would select 157 as the primary channel and 161 as the secondary channel. ● below: Entering a channel number and selecting the below radio button in the WebUI selects a primary and secondary channel for 40 MHz mode. When you use this option, the number entered becomes the primary channel and the secondary channel is determined by decreasing the primary channel number by 4. For example, if you entered 157 into the Channel field and selected the below option, radios using that profile would select 157 as the primary channel and 153 as the secondary channel. <p>If you select the spectrum monitoring checkbox on this profile page, the AP will operate as a hybrid AP and scan the selected channel for spectrum analysis data.</p>
Non 802.11 Interference Immunity	<p>Set a value for 802.11 Interference Immunity.</p> <p>The default setting for this parameter is level 2. When performance drops due to interference from non-802.11 interferers (such as DECT or Bluetooth devices), the level can be increased up to level 5 for improved performance. However, increasing the level makes the AP slightly “deaf” to its surroundings, causing the AP to lose a small amount of range.</p> <p>The levels for this parameter are:</p> <ul style="list-style-type: none"> ● Level 0: no ANI adaptation. ● Level 1: noise immunity only. ● Level 2: noise and spur immunity. ● Level 3: level 2 and weak OFDM immunity. ● Level 4: level 3 and FIR immunity. ● Level 5: disable PHY reporting. <p>NOTE: Only 802.11n-capable APs simultaneously support both the RX Sensitivity Tuning Based Channel Reuse feature and a level-3 to level-5 Noise Immunity setting. Do not raise the noise immunity default setting on APs that do not support 802.11n unless you first disable the Channel Reuse feature.</p>
Spectrum Monitoring	<p>Select this option to convert APs using this radio profile to a hybrid APs that will continue to serve clients as an Access Point, but will also scan and analyze spectrum analysis data for a single radio channel. For more details on hybrid APs, see "Spectrum Analysis" on page 570.</p>
Advertise 802.11d and 802.11h Capabilities	<p>Enable the radio to advertise its 802.11d (Country Information) and 802.11h (Transmit Power Control) capabilities. This option is disabled by default.</p>
Basic 802.11a/802.11g Settings – Spectrum Load Balancing	
Spectrum load balancing	<p>The Spectrum Load Balancing feature helps optimize network resources by balancing clients across channels, regardless of whether the AP or the controller is responding to the wireless clients' probe requests.</p> <p>If enabled, the controller compares whether or not an AP has more clients than its neighboring APs on other channels. If an AP's client load is at or over a predetermined threshold as compared to its immediate neighbors, or if a neighboring Dell AP on another channel does not have any clients, load balancing will be enabled on that AP. This feature is disabled by default. For details, see "Enabling Spectrum Load Balancing" on page 359.</p>
Spectrum load balancing mode	<p>The spectrum load balancing mode allows you to allows control over how to balance clients. Select one of the following options:</p>

Parameter	Description
	<ul style="list-style-type: none"> ● channel: Channel-based load-balancing balances clients across channels. This is the default load-balancing mode ● radio: Radio-based load-balancing balances clients across APs.
Spectrum Load Balancing Interval	Specify how often spectrum load balancing calculations are made (in seconds). The supported range is 1-2147483647 seconds and the default value is 30 seconds.
Spectrum Load Balancing threshold	If the spectrum load balancing feature is enabled, this parameter controls the percentage difference between number of clients on a channel that triggers load balancing. The default value is 20%, meaning that spectrum load balancing is activated when there are 20% more clients on one channel than on another channel used by the AP radio.
Spectrum Load Balancing Domain	<p>Enter a spectrum load balancing domain name to manually create RF neighborhoods. Use this option to create RF neighborhood information for networks that have disabled Adaptive Radio Management (ARM) scanning and channel assignment.</p> <ul style="list-style-type: none"> ● If spectrum load balancing is enabled in a 802.11a or 802.11g radio profile but the spectrum load balancing domain is <i>not</i> defined, ArubaOS uses the ARM feature to calculate RF neighborhoods. ● If spectrum load balancing is enabled in a 802.11a or 802.11g radio profile and a spectrum load balancing domain <i>is also</i> defined, AP radios belonging to the same spectrum load balancing domain will be considered part of the same RF neighborhood for load balancing, and will not recognize RF neighborhoods defined by the ARM feature.
Advanced 802.11a/802.11g Settings	
CSA Count	Number of channel switch announcements that must be sent prior to switching to a new channel. The default CSA count is 4 announcements.
Beacon Period	Beacon Period for the AP in msec. The minimum value is 60 msec, and the default value is 100 msec.
Beacon Regulate	Enable this setting to introduce randomness in the beacon generation so that multiple APs on the same channel do not send beacons at the same time.
Advertised Regulatory Max EIRP	Work around a known issue on Cisco 7921G telephones by specifying a cap for a radio's maximum equivalent isotropic radiated power (EIRP). When you enable this parameter, even if the regulatory approved maximum for a given channel is higher than this EIRP cap, the AP radio using this profile will advertise only this capped maximum EIRP in its radio beacons. The supported range is 1-31dBm.
ARM/WIDS Override	If selected, this option disables Adaptive Radio Management (ARM) and Wireless IDS functions and slightly increases packet processing performance. If a radio is configured to operate in Air Monitor mode, then the ARM/WIDS functions are always enabled, regardless of whether or not this check box is selected.
Management Frame Throttle Interval	Averaging interval for rate limiting management frames from this radio, in seconds. A management frame throttle interval of 0 seconds disables rate limiting.
Management Frame Throttle Limit	Maximum number of management frames that can come in from this radio in each throttle interval.
Maximum Distance	<p>Maximum client distance, in meters. This value is used to derive ACK and CTS timeout times. A value of 0 specifies default settings for this parameter, where timeouts are only modified for outdoor mesh radios which use a distance of 16km.</p> <p>The upper limit for this parameter varies from 24km–58km, depending on the radio's band (a/g) and 20/40 MHz mode. Note that if you configure a value above the supported maximum, the maximum supported value will be used instead. Values below 600m will use default settings.</p>

Parameter	Description
RX Sensitivity Tuning Based Channel Reuse	<p>In some dense deployments, it is possible for APs to hear other APs on the same channel. This creates co-channel interference and reduces the overall utilization of the channel in a given area. Channel reuse enables dynamic control over the receive (Rx) sensitivity in order to improve spatial reuse of the channel.</p> <p>This feature is disabled by default. To enable this feature, click the RX Sensitivity Tuning Based Channel Reuse drop-down list and select either static or dynamic. To disable this feature, click the RX Sensitivity Tuning Based Channel Reuse drop-down list and select disable. For details on each of these modes, see "Reusing Channels to Control RX Sensitivity Tuning" on page 360.</p> <p>NOTE: Do not enable the Channel Reuse feature if "Non 802.11 Interference Immunity" on page 426 is set to level 3 or higher. A level-3 to level-4 Noise Immunity setting is not compatible with the Channel Reuse feature. The channel reuse feature applies to non-DFS channels only. It is internally disabled for DFS channels and does not affect DFS radar signature detection.</p>
RX Sensitivity Threshold	<p>RX sensitivity tuning based channel reuse threshold, in - dBm.</p> <p>If the Rx Sensitivity Tuning Based Channel reuse feature is set to static mode, this parameter manually sets the AP's Rx sensitivity threshold (in -dBm). The AP will filter out and ignore weak signals that are below the channel threshold signal strength.</p> <p>If the value for this parameter is set to zero, the feature will automatically determine an appropriate threshold.</p>
Protection for 802.11b Clients	<p>(For 802.11g RF Management Profiles only) Enable or disable protection for 802.11b clients. This parameter is enabled by default. Disabling this feature may improve performance if there are no 802.11b clients on the WLAN.</p> <p>WARNING: Disabling protection violates the 802.11 standard and may cause interoperability issues. If this feature is disabled on a WLAN with 802.11b clients, the 802.11b clients will not detect an 802.11g client talking and can potentially transmit at the same time, thus garbling both frames.</p>
Associated Profiles	
ARM profile	<p>Dell's proprietary Adaptive Radio Management (ARM) technology maximizes WLAN performance by dynamically and intelligently choosing the best 802.11 channel and transmit power for each Dell AP in its current RF environment.</p> <p>Every RF management profile references an ARM profile. If you specify an active and enabled ARM profile, you do not need to manually configure the Channel and Transmit Power parameters for this 802.11a or 802.11g profile. For details on referencing an ARM profile, see "Assigning an ARM Profile" on page 430.</p> <p>The Adaptive Radio Management (ARM) profile associated with this 802.11a or 802.11g radio profile appears beneath the 802.11a/802.11g radio profile name in the profiles list. To change the ARM profile associated with an 802.11a or 802.11g radio profile, select the associated ARM profile in the profiles list then click the drop-down list in the Profile Details section of the page to select a new profile.</p>
High-throughput radio profile	<p>A high-throughput profile manages 40 MHz tolerance settings, and controls whether or not APs using this profile will advertise intolerance of 40 MHz operation. (This option is disabled by default, allowing 40 MHz operation.)</p> <p>A high-throughput profile also determines whether an AP radio using the profile will stop using the 40 MHz channels surrounding APs or stations advertise 40 MHz intolerance. This option is enabled by default. For details on referencing a high-throughput radio profile, see "Assigning a High-throughput Profile" on page 429.</p> <p>The high-throughput radio profile associated with this 802.11a or 802.11g radio profile appears beneath the 802.11a/802.11g radio profile name in the profiles list. To change the high-throughput radio profile associated with an 802.11a or 802.11g radio profile, select the associated high-throughput radio profile in the profiles list then click the drop-down list in the Profile Details section of the page to select a new profile.</p>

Parameter	Description
Spectrum Monitoring Profile	The spectrum monitoring profile defines the spectrum band and device ageout times used by a spectrum monitor radio. The spectrum monitoring profile associated with this 802.11a or 802.11g radio profile appears beneath the 802.11a/802.11g radio profile name in the profiles list. To change the spectrum monitoring profile associated with an 802.11a or 802.11g radio profile, select the associated spectrum monitoring profile in the profiles list then click the drop-down list in the Profile Details section of the page to select a new profile.
AM Scanning Profile	The AM scanning profile associated with this 802.11a or 802.11g radio profile appears beneath the 802.11a/802.11g radio profile name in the profiles list. To change the AM scanning profile associated with an 802.11a or 802.11g radio profile, select the associated AM scanning profile in the profiles list then click the drop-down list in the Profile Details section of the page to select a new profile.

Assigning an 802.11a/802.11g Profile

Use the following procedure to assign an 802.11a or 802.11g RF management profile to an AP group or individual AP using the WebUI.

- Navigate to the Configuration > Wireless > AP Configuration window. Select either the AP Group or AP Specific tab.
 - If you selected **AP Group**, click the **Edit** button by the AP group name to which you want to assign a new 802.11a or 802.11g RF management profile.
 - If you selected **AP Specific**, click the **Edit** button by the AP to which you want to assign a new 802.11a or 802.11g RF management profile
- Under the **Profiles** list, expand the **RF management** menu, then select either **802.11a radio profile** or **e802.11g radio profile**.
- To select a 802.11a radio profile for an AP or AP group, click the **802.11a radio profile** drop-down list in the **Profile Details** window pane and select the desired profile from the list.
-or-
To select a 802.11g radio profile for an AP or AP group, click the **802.11g radio profile** drop-down list in the **Profile Details** window pane and select the desired profile from the list.
- Click **Apply**. The profile name appears in the Profile list with your configured settings. If you configure this for the AP group, this profile also becomes the selected 802.11a or 802.11g RF management profile used by the mesh portal for your mesh network.

Assigning a High-throughput Profile

Each 802.11a or 802.11g RF management radio profile references a high-throughput profile that manages the AP group's 40Mhz tolerance settings. By default, an 802.11a profile references a high-throughput profile named default-a and an 802.11g profile references a high-throughput profile named default-g. If you do not want to use these default profiles, use the procedure below to reference a different high-throughput profile for your 802.11a or 802.11g RF management profiles.

- Navigate to the Configuration > Wireless > AP Configuration window. Select either the **AP Group** or **AP Specific** tab.
 - If you selected **AP Group**, click the **Edit** button by the AP group name to which you want to assign a new high-throughput profile.
 - If you selected **AP Specific**, click the **Edit** button by the AP which you want to assign a new high-throughput profile.

2. In the **Profiles** list, expand the **RF Management** menu, then select either **802.11a radio profile** or **802.11g radioprofile**.
3. Select **High-throughput radio profile**. The **Profile Details** pane appears and displays information for the currently referenced high-throughput profile. Use this window pane to select a different high-throughput profile, or to create an entirely new high-throughput profile for that 802.11a or 802.11g radio.
 - To reference a different high-throughput profile, click the **High-throughput Radio Profile** drop-down list and select a new profile name from the list. Click **Apply** to save your changes.
 - To create a new high-throughput profile, click the **High-throughput Radio Profile** drop-down list and select **NEW**.
 - a. Enter a name for the new high-throughput profile.
 - b. (Optional) Select **40 MHz intolerance** if you want to enable 40 MHz intolerance. This parameter controls whether or not APs using this high-throughput profile will advertise intolerance of 40 MHz operation. By default, this option is disabled and 40 MHz operation is allowed.
 - d. (Optional) Select **honor 40 MHz intolerance** to allow a radio using this profile to stop using the 40 MHz channels if the 40 MHz intolerance indication is received from another AP or station. This option is enabled by default.
 - d. Click **Apply** to save your settings.
4. The high-throughput profile appears in the **Profile** list with your configured settings.

Assigning an ARM Profile

By default, an 802.11a or 802.11g profile references an ARM profile named **default**. Most network administrators will find that this one default ARM profile is sufficient to manage all the Dell APs on their WLAN. If, however, you do not want to use this default ARM profile, use the procedure below to reference a different ARM profile for your 802.11a or 802.11g RF management profiles.

1. Navigate to the **Configuration > Wireless > AP Configuration** window. Select either the **AP Group** or **AP Specific** tab.
 - If you selected **AP Group**, click the **Edit** button by the AP group name to which you want to assign a new ARM profile.
 - If you selected **AP Specific**, click the **Edit** button by the AP which you want to assign a new ARM profile.
2. Under the Profiles list, expand the **RF Management** menu.
3. To reference an ARM profile for a 802.11a radio profile, expand the **802.11a radio** profile menu.
-or-
To reference an ARM profile for a 802.11g radio profile, expand the **802.11g radio** profile menu.
4. The **Profile Details** pane appears and displays information for the currently referenced ARM profile. You can now select a different profile, or create an entirely new ARM profile for that 802.11a or 802.11g radio.
 - To reference a different ARM profile, click the **Adaptive Radio Management (ARM) Profile** drop-down list and select a new profile name from the list. Click **Apply** to save your changes.
 - To create a new ARM profile, click the **Adaptive Radio Management (ARM) Profile** drop-down list and select **NEW**.
 - a. Enter a name for your new ARM profile.
 - b. (Optional) If you are not configuring ARM for a mesh node, select **40 MHz intolerance** if you want to enable 40 MHz intolerance. This parameter controls whether or not APs using this high-throughput profile will advertise intolerance of 40 MHz operation. By default, this option is disabled and 40 MHz operation is allowed.

c. (Optional) If you are not configuring ARM for a mesh node, select **honor 40 MHz intolerance** to allow a radio using this profile to stop using the 40 MHz channels if the 40 MHz intolerance indication is received from another AP or station. This option is enabled by default.

5. Click **Apply** to save your settings.

The ARM profile name appears in the Profile list with your configured settings. If you configured this profile for the AP group, this ARM profile becomes part of the selected 802.11a or 802.11g RF management profile used by the mesh portal for your mesh network.

Deleting a Profile

You can delete an 802.11a or 802.11g radio profile only if no APs or AP groups are associated with that profile. To delete a 802.11a or 802.11g radio profile using the WebUI.

1. Navigate to the **Configuration > Advanced Services > All Profiles** window.
2. Expand the **RF Management** menu, then select **802.11a radio profile** or **802.11g radio profile**. A list of profiles of the specified type appears in the **Profile Details** window pane.
3. Click the **Delete** button by the name of the profile you want to delete.

Managing 802.11a/802.11g Profiles Using the CLI

You must be in config mode to create, modify or delete a 802.11a or 802.11g RF management radio profile using the CLI. Specify an existing mesh profile with the <profile-name> parameter to modify an existing profile, or enter a new name to create an entirely new profile.

Creating or Modifying a Profile

Configuration details and any default values for each of these parameters are described in [Table 122](#). This CLI command also allows you to reference an ARM profile and high-throughput radio profile for the 802.11a or 802.11g radio. If you do not specify a parameter for a new profile, that profile uses the default value for that parameter. Put the **no** option before any parameter to remove the current value for that parameter and return it to its default setting. Enter **exit** to leave the 802.11a or 802.11g profile mode.

```
rf dot11a-radio-profile|dot11g-radio-profile <profile-name>
am-scan-profile
arm-profile
beacon-period
beacon-regulate
cap-reg-eirp
channel <num|num+|num->
channel-reuse
channel-reuse-threshold
clone
csa
csa-count
disable-arm-wids-function
dot11b-protection (for 802.11g radio profiles only)
dot11h
high-throughput-enable
ht-radio-profile
interference-immunity
maximum-distance
mgmt-frame-throttle-interval
mgmt-frame-throttle-limit
mode {ap-mode|am-mode|spectrum-mode}
no
radio-enable
slb-mode
```

```
slb-threshold
slb-update-interval
spectrum-load-bal-domain
spectrum-load-balancing
spectrum-monitoring
spectrum-profile
tpc-power
tx-power
```

You can also create a new 802.11a or 802.11g RF management profile by copying the settings of an existing profile using the `clone` parameter. Using the `clone` command to create a new profile makes it easier to keep constant attributes in common within multiple profiles.

```
rf dot11a-radio-profile <profile-name> clone <source-profile-name>
rf dot11g-radio-profile <profile-name> clone <source-profile-name>
```

Viewing RF Management Settings

To view a complete list of 802.11a or 802.11g RF management profiles and their status:

```
show rf dot11a-radio-profile|dot11g-radio-profile
```

To view the settings of a specific RF management profile:

```
show rf dot11a-radio-profile|dot11g-radio-profile <profile-name>
```

Assigning a 802.11a/802.11g Profile

To assign an 802.11a or 802.11g RF management profile to an AP group:

```
ap-group <group> dot11a-radio-profile <profile-name>
```

-or-

```
ap-group <group> dot11g-radio-profile <profile-name>
```

To assign an 802.11a or 802.11g RF management profile to an individual AP:

```
ap-name <name> dot11a-radio-profile <profile-name>
```

-or-

```
ap-name <name> dot11g-radio-profile <profile-name>
```

Deleting a Profile

If no AP or AP group is using an RF management profile, you can delete that profile using the `no` parameter:

```
no rf dot11a-radio-profile <profile-name>
```

RF Optimization

Each AP includes an RF Optimization profile that allows you to configure settings for detecting interference. The controller can detect interference near a wireless client station or AP is based on an increase in the frame retry rate or frame receive error rate.

Using the WebUI

1. Navigate to the **Configuration > Wireless > AP Configuration** window. Select either the **AP Group** or **AP Specific** tab.
 - If you selected the **AP Group** tab, click the **Edit** button by the AP group name for which you want to configure the RF Optimization profile.
 - If you selected the **AP Specific** tab, click the **Edit** button by the AP for which you want to create the RF Optimization profile.
2. Expand the **RF Management** menu, then expand the **RF Optimization Profile** menu.

- Select the profile you want to edit from the **Profile Details** window pane.
or
Enter a new RF Optimization profile name in the field at the bottom of the **Profile Details** window, then click **Add**. Next, select that profile name from the profile list to edit its parameters.
- Configure your RF Optimization radio settings. [Table 123](#) describes the parameters. Click **Apply** to save your settings.

Table 123: RF Optimization Profile Parameters

Parameter	Description
Station Handoff Assist	Allows the controller to force a client off an AP when the RSSI drops below a defined minimum threshold. Default: Disabled
RSSI Falloff Wait Time	Time, in seconds, to wait with decreasing RSSI before a de-authorization message is sent to the client. Maximum value: 8 seconds Default value: 0 seconds
Low RSSI Threshold	Minimum RSSI above which de-authorization messages should never be sent.
RSSI Check Frequency	Interval, in seconds, to sample RSSI.

Using the CLI

Use the following command to configure RF Optimization profiles. The parameters described in [Table 123](#).

```
rf optimization-profile <profile>
clone <profile>
handoff-assist
low-rssi-threshold <number>
no ...
rssi-check-frequency <number>
rssi-falloff-wait-time <seconds>
```

RF Event Configuration

An AP's event threshold profile configures Received Signal Strength Indication (RSSI) metrics, including high and low watermarks for frame error rates and frame retry rates. When certain RF parameters are exceeded, these events can signal excessive load on the network, excessive interference, or faulty equipment.



NOTE: This profile and many of the detection parameters are disabled (value is 0) by default.

The following procedure details the steps to configure RF Event parameters.

Using the WebUI

- Navigate to the **Configuration > Wireless > AP Configuration** window. Select either the **AP Group** or **AP Specific** tab.
 - If you selected the **AP Group** tab, click the **Edit** button by the AP group name for which you want to configure the RF Event profile.
 - If you selected the **AP Specific** tab, click the **Edit** button by the AP for which you want to create the RF Event profile.
- In the Profiles list, expand the **RF Management** menu, then expand the **RF Event Profile** menu.

3. To edit an existing RF Event profile, select the profile you want to edit from the **Profile Details** window pane.
-or-
4. To create a new profile, enter a new RF Event profile name in the field at the bottom of the **Profile Details** window, then click **Add**. Next, select that profile name from the profile list to edit its parameters.
5. Configure your settings as detailed in [Table 124](#) and click **Apply** to save your settings.

Table 124: RF Event Thresholds Profile Parameters

Parameter	Description
Detect Frame Rate Anomalies	Enable or disables detection of frame rate anomalies. This feature is disabled by default.
Bandwidth Rate High Watermark	If bandwidth in an AP exceeds this value, a bandwidth exceeded condition exists. The value represents the percentage of maximum for a given radio. (For 802.11b, the maximum bandwidth is 7 Mbps. For 802.11 a and g, the maximum is 30 Mbps.) The recommended value is 85%.
Bandwidth Rate Low Watermark	After a bandwidth exceeded condition exists, the condition persists until bandwidth drops below this value. The recommended value is 70%.
Frame Error Rate High Watermark	If the frame error rate (as a percentage of total frames in an AP) exceeds this value, a frame error rate exceeded condition exists. The recommended value is 16%.
Frame Error Rate Low Watermark	After a frame error rate exceeded condition exists, the condition persists until the frame error rate drops below this value. The recommended value is 8%.
Frame Fragmentation Rate High Watermark	If the frame fragmentation rate (as a percentage of total frames in an AP) exceeds this value, a frame fragmentation rate exceeded condition exists. The recommended value is 16%.
Frame Fragmentation Rate Low Watermark	After a frame fragmentation rate exceeded condition exists, the condition persists until the frame fragmentation rate drops below this value. The recommended value is 8%.
Frame Low Speed Rate High Watermark	If the rate of low-speed frames (as a percentage of total frames in an AP) exceeds this value, a low-speed rate exceeded condition exists. This could indicate a coverage hole. The recommended value is 16%.
Frame Low Speed Rate Low Watermark	After a low-speed rate exceeded condition exists, the condition persists until the percentage of low-speed frames drops below this value. The recommended value is 8%.
Frame Non Unicast Rate High Watermark	If the non-unicast rate (as a percentage of total frames in an AP) exceeds this value, a non-unicast rate exceeded condition exists. This value depends upon the applications used on the network.
Frame Non Unicast Rate Low Watermark	After a non-unicast rate exceeded condition exists, the condition persists until the non-unicast rate drops below this value.
Frame Receive Error Rate High Watermark	If the frame receive error rate (as a percentage of total frames in an AP) exceeds this value, a frame receive error rate exceeded condition exists. The recommended value is 16%.
Frame Receive Error Rate Low Watermark	After a frame receive error rate exceeded condition exists, the condition persists until the frame receive error rate drops below this value. The recommended value is 8%.

Parameter	Description
Frame Retry Rate High Watermark	If the frame retry rate (as a percentage of total frames in an AP) exceeds this value, a frame retry rate exceeded condition exists. The recommended value is 16%.
Frame Retry Rate Low Watermark	After a frame retry rate exceeded condition exists, the condition persists until the frame retry rate drops below this value. The recommended value is 8%.

Using the CLI

Use the following command to configure RF event profiles. The available parameters for this profile are detailed in [Table 124](#).

```
rf event-thresholds-profile <profile>
bwr-high-wm <percent>
bwr-low-wm <percent>
clone <profile>
detect-frame-rate-anomalies
fer-high-wm <percent>
fer-low-wm <percent>
ffr-high-wm <percent>
ffr-low-wm <percent>
flsr-high-wm <percent>
flsr-low-wm <percent>
fnur-high-wm <percent>
fnur-low-wm <percent>
frer-high-wm <percent>
frer-low-wm <percent>
frr-high-wm <percent>
frr-low-wm <percent>
```

Configuring AP Channel Assignments

The country code in the AP Regulatory Domain profile determines supported channel and channel pairs for that specific AP. Any changes to the country code causes the valid channel lists to be reset to the defaults for the country.

The example in this section illustrates how to perform the following tasks for an AP group:

1. Configure the “default” regulatory domain profile to use a valid country code. (In this example, the country code US.) This will determine the available channels.
2. Configure a 40 MHz channel (bonded pair) for the AP group’s 802.11a (5 GHz) radio profile.
3. Configure a 20 MHz channel for the AP group’s 802.11g (2.4 GHz) radio profile.

NOTE: This example uses default ARM profile settings and the recommended high-throughput channel assignments for the 802.11a and 802.11b/g bands. If you want the channel assignments to utilize high-throughput, ensure that high-throughput is enabled within the radio profile. For details, see ["Configuring a Virtual AP" on page 316](#).

Using the WebUI

1. Navigate to **Configuration > Wireless > AP Configuration > AP Group** page.
2. Click the **Edit** button by the name of the AP group to which you want to assign specific channels.
3. In the Profiles list, expand the AP menu to display the AP profiles used by the AP group.
4. Select the **Regulatory Domain profile** named **default**.
5. In the **Country Code** drop-down menu and select the **US-United States domain** if it is not already selected.

The Regulatory Domain's country code determines which channels are selected in the **Valid 802.11g channel**, **Valid 802.11a channel**, **Valid 802.11g 40MHz channel pair** and **Valid 802.11a 40MHz channel pair** fields. If none of the channels supported by the AP have received regulatory approval by the country whose country code you selected, the AP will revert to Air Monitor mode.

6. Click **Apply**.
7. Under the Profiles list, expand the **RF Management** menu.
8. Select the **802.11a radio profile** used by the AP group
9. Enter **36** in the **Channel** text field and select the **Above** radio button. In this instance, channel 36 becomes the primary channel and the secondary channel is 40.
10. Click **Apply**.
11. Under the Profiles list select the **802.11g radio profile** used by the AP group.
12. Enter **1** in the **Channel** text field and select the **None** radio button. In this instance, channel 1 is the assigned 20 MHz channel and 40 MHz mode is disabled and click **Apply**.

Using the CLI

Country codes are generally specified in ISO 3166 format. To see what channels are available for a given country code, use the `show ap allowed-channels <country-code>` command can be used.

```
ap regulatory-domain-profile default
  country-code US
rf dot11a-radio-profile ht-corpnet-a
  channel 36+
rf dot11g-radio-profile ht-corpnet-g
  channel 1
```



NOTE: Country codes are generally specified in ISO 3166 format. To see what channels are available for a given country code, use the `show ap allowed-channels country-code <country-code>` command.

Channel Switch Announcement (CSA)

When an AP changes its channel, an existing wireless clients may “time out” while waiting to receive a new beacon from the AP; the client must begin scanning to discover the new channel on which the AP is operating. If the disruption is long enough, the client may need to reassociate, reauthenticate, and re-request an IP address. Channel Switch Announcement (CSA), as defined by IEEE 802.11h, enables an AP to announce that it is switching to a new channel before it begins transmitting on that channel. This allows the clients, who support CSA, to transition to the new channel with minimal downtime.

When CSA is enabled, the AP does not change to a new channel immediately. Instead, it sends a number of beacons (the default is 4) which contain the CSA announcement before it switches to the new channel. You can configure the number of announcements sent before the change.



NOTE: Clients must support CSA in order to track the channel change without experiencing disruption.

Using the WebUI

1. Navigate to the **Configuration > Wireless > AP Configuration** page.
2. Select either the AP Group or AP Specific tab. Click **Edit** for the AP group or AP name.
3. Select RF Management in the Profile list.
4. Select the 802.11a or 802.11g radio profile.
5. Select Enable CSA. You can configure a different value for CSA Count.

6. Click Apply.

Using the CLI

```
rf radio-profile <profile>
  csa
  csa-count <number>
```

Automatic Channel and Transmit Power Selection

To allow automatic channel and transmit power selection based on the radio environment, enable Adaptive Radio Management (ARM). Note that ARM assignments will override the static channel and power configurations done using the radio profile. For complete information on the Adaptive Radio Management feature, refer to [Adaptive Radio Management \(ARM\) on page 346](#).

Managing AP Console Settings

An AP's provisioning parameters are unique to each AP. These parameters are initially configured on the controller and then pushed out to the AP and stored on the AP itself. **Best practices are to configure an AP's provisioning settings using the controller WebUI.** If you find it necessary to alter an AP's provisioning settings for troubleshooting purposes, you can do so using the controller WebUI and CLI, or alternatively, through a console connection to the AP itself.

To create a console connection to the AP:

1. Connect a local console to the serial port on the AP. You can connect the AP's serial port to a terminal or terminal server using an Ethernet cable, or connect the serial console port to a DB-9 adapter, then connect the adapter to a laptop using an RS-232 cable. For details on connecting to an AP's serial console port, refer to the Installation Guide included with the AP.
2. Establish a console communication to the AP, then power-cycle the AP to reboot it.
3. To access the AP console command prompt, press **Enter** when the AP displays the message "*Hit <Enter> to stop autoboot.*" If the autoboot countdown expires before you can interrupt it, turn the device off and then back on.
4. Once the AP boot prompt appears, you can issue any of the AP provisioning commands described in the [Table 125](#). Remember, though these commands may be useful for troubleshooting, they are all optional and are *not* necessary for normal AP provisioning.

Table 125: AP Console Commands

Command	Description
setenv ipaddr <ipaddr>	IP address to be assigned to the AP.
setenv netmask <netmaskip>	Netmask to be assigned to the AP.
setenv gatewayip <ipaddr>	IP address of the internet gateway used by the AP.
setenv name <ap name>	Name of the AP.
setenv group <group name>	Name of the AP group to which the AP should belong.

Command	Description
setenv master <ipaddr>	IP address of the AP's master controller.
setenv serverip <ipaddr>	IP address of the TFTP server from which the AP can download its boot image.
setenv dnsip <ipaddr>	IP address of the DNS server used by the AP.
setenv domainname <domain>	Domain name used by the AP.

5. When you are finished, type **Save** and then press **Enter** to save your settings.



NOTE: Other AP console commands may be available when accessing an AP directly through its console port, but these commands can cause configuration errors if used improperly and should only be issued under the direct supervision of Dell technical support.

The example below configures an AP location and domain name using an AP console connection:

```
Hit <Enter> to stop autoboot: 0
apboot> <INTERRUPT>
apboot>setenv group corporate2
apboot>setenv domainname mycompany.com
apboot>save
apboot>reboot
```

To view current AP settings using the AP console, issue the command `printenv <name>` where `<name>` is one of the variable names listed in [Table 125](#), such as `ipaddr`, `dnsip` or `gatewayip`.

```
apboot> printenv domainname
domainname=mycompany.com
```

Chapter 24

Secure Enterprise Mesh

The Dell secure enterprise mesh solution is an effective way to expand network coverage for outdoor and indoor enterprise environments without any wires. Using mesh, you can bridge multiple Ethernet LANs or you can extend your wireless coverage. As traffic traverses across mesh APs, the mesh network automatically reconfigures around broken or blocked paths. This self-healing feature provides increased reliability and redundancy: the network continues to operate if an AP stops functioning or a connection fails.

Dell controllers provide centralized configuration and management for APs in a mesh environment; local mesh APs provide encryption and traffic forwarding for mesh links. This chapter describes the Dell secure enterprise mesh architecture, in the following topics:

- ["Understanding Mesh Access Points" on page 439](#)
- ["Understanding Mesh Links" on page 441](#)
- ["Understanding Mesh Profiles " on page 443](#)
- ["Understanding Mesh Solutions " on page 445](#)
- ["Planning Deployment" on page 794](#)
- ["Working with Mesh Radio Profiles" on page 450](#)
- ["Working with Mesh High Throughput SSID Profiles " on page 455](#)
- ["Understanding Mesh Cluster Profiles" on page 459](#)
- ["Configuring Ethernet Ports for Mesh" on page 464](#)
- ["Provisioning Mesh Nodes" on page 467](#)
- ["Understanding the AP Boot Sequence " on page 469](#)
- ["Verifying the Network" on page 470](#)
- ["Configuring Remote Mesh Portals \(RMPs\)" on page 471](#)

 **NOTE:** Dell strongly recommends staging mesh APs before you deploy them. Identify the physical location of the APs, configure them for mesh, provision the APs and verify connectivity before physically deploying them in a live network. For other pre-installation considerations, see ["Planning Deployment" on page 794](#).

Understanding Mesh Access Points

Mesh APs learn about their environment when they boot up. Mesh APs are either configured as a mesh portal (MPP), an AP that uses its wired interface to reach the controller, or a mesh point (MP), an AP that establishes an all-wireless path to the mesh portal. Mesh APs locate and associate with their nearest neighbor, which provides the best path to the mesh portal. Mesh portals and mesh points are also known as mesh nodes, a generic term used to describe APs configured for mesh.

A mesh radio's bandwidth can be shared between mesh-backhaul traffic and client traffic. You can, however, configure a radio for mesh services only. If you have a dual-radio AP, a mesh node can be configured to deliver client services on one radio and both mesh and WLAN services to clients on the other. If you configure a single-radio AP

to deliver mesh services only (by disabling the mesh radio in its 802.11a or 802.11g radio profile) that mesh node can not deliver WLAN services to its clients.

For mesh as well as traditional thin AP deployments, the Dell controller provides centralized provisioning, configuration, policy definition, ongoing network management and wireless and security services. However, unlike the traditional thin AP case, mesh nodes also perform network traffic encryption and decryption, and packet forwarding over wired and wireless links.

You configure the AP for mesh on the controller using either the WebUI or the CLI. All mesh related configuration parameters are grouped into mesh profiles that you can apply as needed to an AP group or to individual APs.

By default, APs operate as thin APs, which means their primary function is to receive and transmit electromagnetic signals; other WLAN processing is left to the controller. When planning a mesh network, you manually configure APs to operate in mesh portal or mesh point roles. Unlike a traditional WLAN environment, local mesh nodes provide encryption and traffic forwarding for mesh links in a mesh environment. Virtual APs are still applied to non-mesh radios.

Provisioning mesh APs is similar to thin APs; however, there are some key differences. Thin APs establish a channel to the controller from which they receive the configuration for each radio interface. Mesh nodes, in contrast, get their radio interfaces up and running *before* making contact with the controller. This requires a minimum set of parameters from the AP group and mesh cluster that enables the mesh node to discover a neighbor to create a mesh link and subsequent channel with the controller. To do this, you must first define and configure the mesh cluster profile *before* configuring an AP to operate as a mesh node. This chapter first describes how to configure the mesh profile, then describes how to configure APs to operate in mesh mode. If you have already configured a complete mesh profile, continue to “Ethernet Ports for Mesh” or “Provisioning Mesh Nodes”.

Mesh Portals

The mesh portal (MPP) is the gateway between the wireless mesh network and the enterprise wired LAN. You configure a Dell AP to perform the mesh portal role, which uses its wired interface to establish a link to the wired LAN. You can deploy multiple mesh portals to support redundant mesh paths (mesh links between neighboring mesh points that establish the best path to the mesh portal) from the wireless mesh network to the wired LAN.

The mesh portal broadcasts the configured mesh service set identifier (MSSID/mesh cluster name), and advertises the mesh network service to available mesh points. Neighboring mesh points that have been provisioned with the same MSSID authenticate to the portal and establish a secure mesh link over which traffic is forwarded. The authentication process requires secure key negotiation, common to all APs, and the mesh link is established and secured using Advanced Encryption Standard (AES) encryption. Mesh portals also propagate channel information, including CSAs.

Mesh Points

The mesh point (MP) is a Dell AP configured for mesh and assigned the mesh point role. Depending on the AP model, configuration parameters, and how it was provisioned, the mesh point can perform multiple tasks. The mesh point provides traditional Dell WLAN services (such as client connectivity, intrusion detection system (IDS) capabilities, user role association, LAN-to-LAN bridging, and Quality of Service (QoS) for LAN-to-mesh communication) to clients and performs mesh backhaul/network connectivity. A mesh radio can be configured to carry mesh-backhaul traffic only. Additionally, a mesh point can provide LAN-to-LAN Ethernet bridging by sending tagged/untagged VLAN traffic across a mesh backhaul/network to a mesh portal.

Mesh points use one of their wireless interfaces to carry traffic and reach the controller. Mesh points are also aware of potential neighbors and can form new mesh links if the current mesh link is no longer preferred or available.

Mesh Clusters

Mesh clusters are similar to an Extended-Service Set (ESS) in a WLAN infrastructure. A mesh cluster is a logical set of mesh nodes that share the common connection and security parameters required to create mesh links. Mesh clusters are grouped and defined by a mesh cluster profile, as described in “Mesh Cluster Profile”.

Mesh clusters may enforce predictability in mesh networking by limiting the amount of concurrent mesh points, hop counts, and bandwidth used in the mesh network. A mesh cluster can have multiple mesh portals and mesh points that facilitate wireless communication between wired LANs. Mesh portals in a mesh cluster do not need to be on the same VLAN. [Figure 126](#) shows two mesh clusters and their relationship to the controller.

Figure 126: *Sample Mesh Clusters*

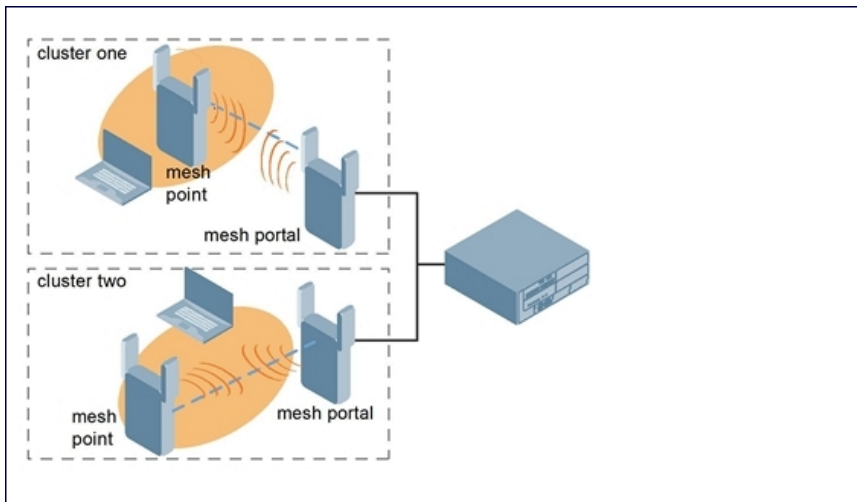

Understanding Mesh Links

In simple terms, the mesh link is the data link between a mesh point and its parent. A mesh point uses the parameters defined in the mesh cluster, specifically the mesh cluster profile, to establish a mesh link with a neighboring mesh point. The mesh link uses a series of metrics to establish the best path to the mesh portal.



NOTE: Through out the rest of this chapter, the term “uplink” is also used to distinguish the active association between a mesh point and its parent.

The following list describes how mesh links are created.

- Creating the initial mesh link
When creating the initial mesh link, mesh points look for others advertising the same MSSID as the one contained in its mesh cluster profile. The mesh point scans the channels in its provisioned band of operation to identify a list of neighbors that match its mesh cluster profile. The mesh point then selects the from highest priority neighbors based on the least expected path cost.
If no provisioned mesh cluster profile is unavailable, mesh points use the recovery profile to establish an uplink. If multiple cluster profiles are configured, mesh points search in order of priority their list of provisioned backup mesh cluster profiles to establish an uplink. If the configured profiles are unavailable after searching for 5 minutes, the recovery profile is used.
- Moving to a better mesh link

If the existing uplink quality degrades below the configured threshold, and a lower cost or more preferable uplink is available on the same channel and cluster, the mesh point reselects that link without re-scanning. In some cases, this invalidates all of the entries that have this mesh point as a next hop to the destination and triggers new learning of the bridge tables.

- Using a new mesh link if the current mesh link goes down

If an uplink goes down, the affected mesh nodes re-establish a connection with the mesh portal by re-scanning to choose a new path to the mesh portal. If a mesh portal goes down, and a redundant mesh portal is available, the affected mesh nodes update their forwarding tables to reflect the path to the new mesh portal.

Link Metrics

Mesh points use the configured algorithm to compute a metric value, or “path cost,” for each potential uplink and select the one with the lowest value as the optimal path to the mesh portal. [Table 127](#) describes the components that make up the metric value: node cost, hop count, link cost and 802.11 capacity.

The link metrics indicate the relative cost of a path to the mesh portal. The best path (lowest metric value) is used to create the uplink.

Table 127: Mesh Link Metric Computation

Component	Description
Node cost	Indicates the amount of traffic expected to traverse the mesh node. The more traffic, the higher the node cost. When establishing a mesh link, nodes with less traffic take precedence. The node cost is dependent on the number of children a mesh node supports. It can change as the mesh network topology changes, for example if new children are added to the network or old children disconnect from the network.
Hop count	Indicates the number of hops it takes the mesh node to get to the mesh portal. The mesh portal advertises a hop count of 0, while all other mesh nodes advertise a cumulative count based on the parent mesh node.
Link cost	Represents the quality of the link to an active neighbor. The higher the Received Signal Strength Indication (RSSI), the better the path to the neighbor and the mesh portal. If the RSSI value is below the configured threshold, the link cost is penalized to filter marginal links. A less direct, higher quality link may be preferred over the marginal link. The following factors also affect mesh link metrics <ul style="list-style-type: none"> • High-throughput APs add a high cost penalty for links to non-high-throughput APs. • Multi-stream high-throughput APs add proportional cost penalties for links to high-throughput APs that support fewer streams.
802.11 capacity	High-throughput APs can send 802.11 information elements (IEs) in their management frames, allowing high-throughput mesh nodes to identify other mesh nodes with a high-throughput capacity. High-throughput mesh points prefer to select other 802.11-capable mesh points in their path to the mesh portal, but can use a legacy path if no high-throughput path is available.
Path Cost	Path cost is calculated by analyzing the other components in this table, and adding the link cost plus mesh parent's path cost plus the parent's node cost. Mesh portals typically advertise a path-cost of zero, but high-throughput portals add an offset penalty if they are connected to a 10/100mbps port that is too slow to for the high-throughput link capacity.

Optimizing Links

You can configure and optimize operation of the link metric algorithm via the mesh radio profile. These configurable mesh link trigger thresholds can determine when the uplink or mesh path is dropped and another is chosen, provide enhanced network reliability, and contain flapping links. Although you can modify the behavior of the link metric algorithm, Dell recommends the default values for most deployments. For information, see ["Metric algorithm" on page 452](#).

Understanding Mesh Profiles

Mesh profiles help define and bring-up the mesh network. The following sections describe the mesh cluster, mesh radio, and mesh recovery profiles in more detail.

The complete mesh profile consists of a mesh radio profile, RF management (802.11a and 802.11g) radio profiles, a high-throughput SSID profile (if your deployment includes 802.11n-capable APs), a mesh cluster profile, and a read-only recovery profile. The recovery profile is dynamically generated by the master controller; you do not explicitly configure the recovery profile.

Dell provides a “default” version of the mesh radio, RF management, high-throughput SSID and cluster profiles with default values for most parameters. You can use the “default” version of a profile or create a new instance of a profile which you can then edit as you need. You can change the values of any parameter in a profile. You have the flexibility of applying the “default” versions of profiles in addition to customizing profiles that are necessary for the AP or AP group to function.

If you assign a profile to an individual AP, the values in the profile override the profile assigned to the AP group to which the AP belongs. The exception is the mesh cluster profile—you can apply multiple mesh cluster profiles to individual APs, as well as to AP groups.

Mesh Cluster Profile

Mesh clusters are grouped and defined by a mesh cluster profile, which provides the framework of the mesh network. Similar to virtual AP profiles, the mesh cluster profile contains the MSSID (mesh cluster name), authentication methods, security credentials, and cluster priority required for mesh nodes to associate with their neighbors and join the cluster. Associated mesh nodes store this information in flash memory. Although most mesh deployments require only a single mesh cluster profile, you can configure and apply multiple mesh cluster profiles to an AP group or an individual AP. If you have multiple cluster profiles, the mesh portal uses the profile with the highest priority to bring up the mesh network. Mesh points, in contrast, go through the list of mesh cluster profiles in order of priority to decide which profile to use to associate themselves with the network. The mesh cluster priority determines the order by which the mesh cluster profiles are used. This allows you, rather than the link metric algorithm, to explicitly segment the network by defining multiple cluster profiles.

Dell provides a “default” version of the mesh cluster profile. You can use the “default” version or create a new instance of a profile which you can then edit as you need. You can configure a maximum of 16 mesh cluster profiles on a mesh node. For details about configuring mesh cluster profiles, see “Mesh Cluster Profiles”.

Mesh Radio Profile

Dell provides a “default” version of the mesh radio profile. You can use the “default” version or create a new instance of a profile which you can then edit as you need. The mesh radio profile allows you to specify the set of rates used to transmit data on the mesh link. For information about configuring mesh radio profiles, see ["Working with Mesh Radio Profiles" on page 450](#).

RF Management (802.11a and 802.11g) Profiles

The two 802.11a and 802.11g RF management profiles for an AP configure its 802.11a (5 GHz) and 802.11b/g (2.4 GHz) radio settings. Use these profile settings to determine the channel, beacon period, transmit power, and ARM profile for a mesh AP's 5 GHz and 2.5 GHz frequency bands. You can either use the “default” version of each profile, or create a new 802.11a or 802.11g profile which you can then configure as necessary. Each RF management profile also has a **radio-enable** parameter that allows you to enable or disable the AP's ability to simultaneously carry WLAN client traffic and mesh-backhaul traffic on that radio. This value is enabled by default. For information about configuring RF Management Radio profiles, see ["802.11a and 802.11g RF Management Profiles" on page 424](#).



NOTE: If you do not want the mesh radios carrying mesh-backhaul traffic to support client traffic, consider using a dedicated 802.11a/802.11g radio profile with the mesh radio disabled: in this scenario, the radio carries mesh backhaul traffic but does not support client Virtual APs.

Mesh nodes operating in different cluster profiles can share the same radio profile. Conversely, mesh portals using the same cluster profile can be assigned different RF Management Radio profiles to achieve frequency separation (for more information, see “Deployments with Multiple Mesh Cluster Profiles”).

Adaptive Radio Management Profiles

Each 802.11a and 802.11g radio profile references an Adaptive Radio Management (ARM) profile. When you assign an active ARM profile to a mesh radio, ARM's automatic power-assignment and channel-assignment features automatically select the radio channel with the least amount of interference for each mesh portal, maximizing end user performance. In earlier versions of this software, an AP with a mesh radio received its beacon period, transmission power and 11a/11g portal channel settings from its mesh radio profile. Mesh-access AP portals now inherit these radio settings from their dot11a or dot11g radio profiles.

Each ARM-enabled mesh portal monitors defined thresholds for interference, noise, errors, rogue APs and radar settings, then calculates interference and coverage values and selects the best channel for its radio band(s). The mesh portal communicates its channel selection to its mesh points via Channel Switch Announcements (CSAs), and the mesh points change their channel to match their mesh portal. Although channel settings can still be defined for a mesh point via that mesh point's 802.11a and 802.11g radio profiles, these settings are overridden by any channel changes from the mesh portal. A mesh point takes the same channel setting as its mesh portal, regardless of its associated clients. If you want to manually assign channels to mesh portals or mesh points, disable the ARM profile associated with the 802.11a or 802.11g radio profile by setting the ARM profile's **assignment** parameter to **disable**.

Mesh points, unlike mesh portals, do not scan channels. This means that once a mesh point has selected a mesh portal or an upstream mesh point, it tunes to this channel, forms the link, and does not scan again unless the mesh link gets broken. This provides good mesh link stability, but may adversely affect system throughput in networks with mesh portals and mesh points. When ARM assigns optimal channels to mesh portals, those portals use different channels, and once the mesh network has formed and all the mesh points have selected a portal (or upstream mesh point), those mesh points are not be able to detect other portals on other channels that could offer better throughput. This type of suboptimal mesh network may form if, for example, two or three mesh points select the same mesh portal after booting, form the mesh network, and leave a nearby mesh portal without any mesh points. Again, this does not affect mesh functionality, but may affect total system throughput. For details about associating an ARM profile with a mesh AP, see ["Assigning an ARM Profile" on page 430](#).

High-Throughput Profiles

Each 802.11a and 802.11g radio profile also references a high-throughput profile that manages an AP or AP group's 40Mhz tolerance settings. For information about referencing a high-throughput profile, see ["Assigning a High-throughput Profile" on page 429](#).

Mesh High-Throughput SSID Profile

High-throughput APs support additional settings not available in legacy APs. A mesh high-throughput SSID profile can enable or disable high-throughput (802.11n) features and 40 MHz channel usage, and define values for aggregated MAC protocol data units (MDPUs) and Modulation and Coding Scheme (MCS) ranges.

Dell provides a “default” version of the mesh high-throughput SSID profile. You can use the “default” version or create a new instance of a profile which you can then edit as you need. High-throughput Mesh nodes operating in different cluster profiles can share the same high-throughput SSID radio profile. For information about configuring mesh high-throughput SSID profiles, see “Mesh High-Throughput SSID Profiles”.

Wired AP Profile

The wired AP profile controls the configuration of the Ethernet port(s) on your AP. You can use the wired AP profile to configure Ethernet ports for bridging or secure jack operation using the wired AP profile. For details, see ["Configuring Ethernet Ports for Mesh" on page 464](#)

Mesh Recovery Profile

In addition to the “default” and user-defined mesh cluster profiles, mesh nodes also have a recovery profile. The master controller dynamically generates a recovery profile, and each mesh node provisioned by the same master controller has the same recovery profile. The recovery profile is based on a pre-shared key (PSK), and mesh nodes use the recovery profile to establish a link to the controller if the mesh link is broken and no other mesh cluster profiles are available.

The mesh portal advertises the provisioned cluster profile. If a mesh point is unaware of the active mesh cluster profile, but is aware of and has the same recovery profile as the mesh portal, the mesh point can use the recovery profile to connect to the mesh portal.

NOTE: The mesh point must have the same recovery profile as the parent to which it connects. If you provision the mesh points with the same master controller, the recovery profiles should match.



To verify that the recovery profile names match, use the following command:

```
show ap mesh debug provisioned-clusters {ap-name <name> | bssid <bssid> | ip-addr <ipaddr>}.
```

To view the recovery profile on the controller, use the following command: `show running-config | include recovery.`

If a mesh point connects to a parent using the recovery profile, it may immediately exit recovery if the parent is actively using one of its provisioned mesh cluster profiles. Once in recovery, a mesh point periodically exits recovery to see if it can connect using an available provisioned mesh cluster profile. The recovery profile is read-only; it cannot be modified or deleted.

The recovery profile is stored in the master Dell controllers’ configuration file and is unique to that master controller. If necessary, you can transfer your configuration to another controller. If you do this, make sure your new mesh cluster is running and you have re-provisioned the mesh nodes before deleting your previous configuration. The APs learn the new recovery profile after they are provisioned with the new controller. This is also true if you provision a mesh node with one master controller and use it with a different master controller. In this case, the recovery profile does not work on the mesh node until you re-provision it with the new master controller.

Understanding Mesh Solutions

You can configure the following single-hop and multi-hop solutions:

- Thin AP services with wireless backhaul deployment
- Point-to-point deployment
- Point-to-multipoint deployment
- High-availability deployment

With a thin AP wireless backhaul deployment, mesh provides services and security to remote wireless clients and sends all control and user traffic to the master controller over a wireless backhaul mesh link.

The remaining deployments allow you to extend your existing wired network by providing a wireless bridge to connect Ethernet LAN segments. You can use these deployments to bridge Ethernet LANs between floors, office buildings, campuses, factories, warehouses and other environments where you do not have access to physical ports or

cable to extend the wired network. In these scenarios, a wireless backhaul carries traffic between the Dell APs configured as the mesh portal and the mesh point, to the Ethernet LAN.

Thin AP Services with Wireless Backhaul Deployment

To expand your wireless coverage without bridging Ethernet LAN segments, you can use thin AP services with a wireless backhaul. In this scenario, the mesh point provides network access for wireless clients and establishes a mesh path to the mesh portal, which uses its wired interface to connect to the controller. Use the 802.11g radio for WLAN and controller services and the 802.11a radio for mesh services. [Figure 128](#) shows the wireless backhaul between the mesh portal to the mesh point that services the wireless clients.

Figure 128: *Sample Wireless Backhaul Deployment*

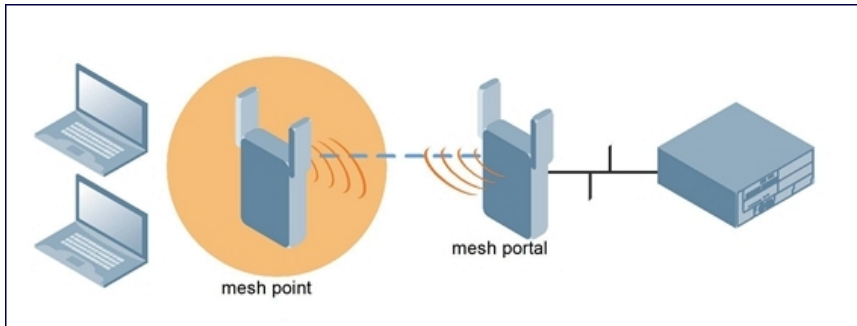

Point-to-Point Deployment

In this point-to-point scenario, two Ethernet LAN segments are bridged via a wireless connection that carries both client services traffic and mesh-backhaul traffic between the mesh portal and the mesh point. This provides communication from one LAN to another. [Figure 129](#) shows a single-hop point-to-point deployment.

Figure 129: *Sample Point-to-Point Deployment*

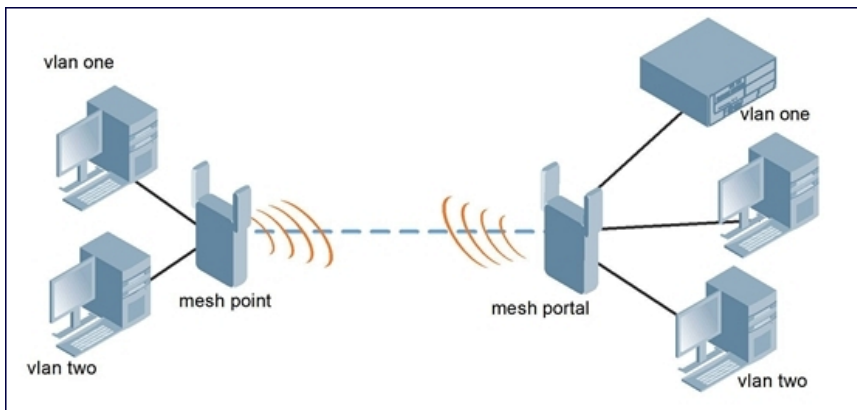

Point-to-Multipoint Deployment

In a point-to-multipoint scenario, multiple Ethernet LAN segments are bridged via multiple wireless/mesh backhauls that carry traffic between the mesh portal and the mesh points. This provides communication from the local LAN to multiple remote LANs. [Figure 130](#) shows a single-hop point-to-multipoint deployment.

Figure 130: Sample Point-to-Multipoint Deployment

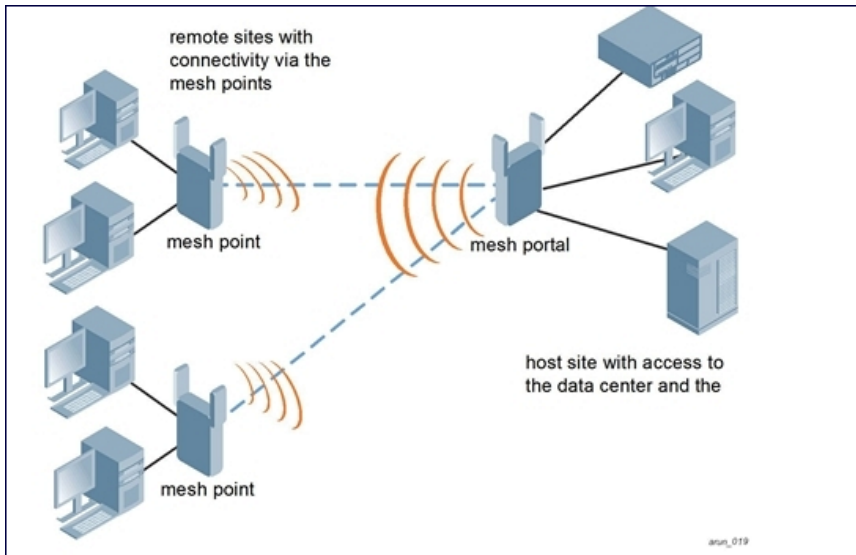

High-Availability Deployment

In this high-availability scenario, multiple Ethernet LAN segments are bridged via multiple wireless backhauls that carry traffic between the mesh portal and the mesh points. You configure one mesh portal for each remote LAN that you are bridging with the host LAN. This provides communication from the host LAN to multiple remote LANs. In the event of a link failure between a mesh point and its mesh portal, the affected mesh point could create a link to the other mesh portal. [Figure 131](#) shows a sample single-hop high-availability deployment. The dashed lines represent the current mesh link between the mesh points and their mesh portals. The diagonal dotted lines represent possible links that could be formed in the event of a mesh link or mesh portal failure.

Figure 131: Sample High-Availability Deployment

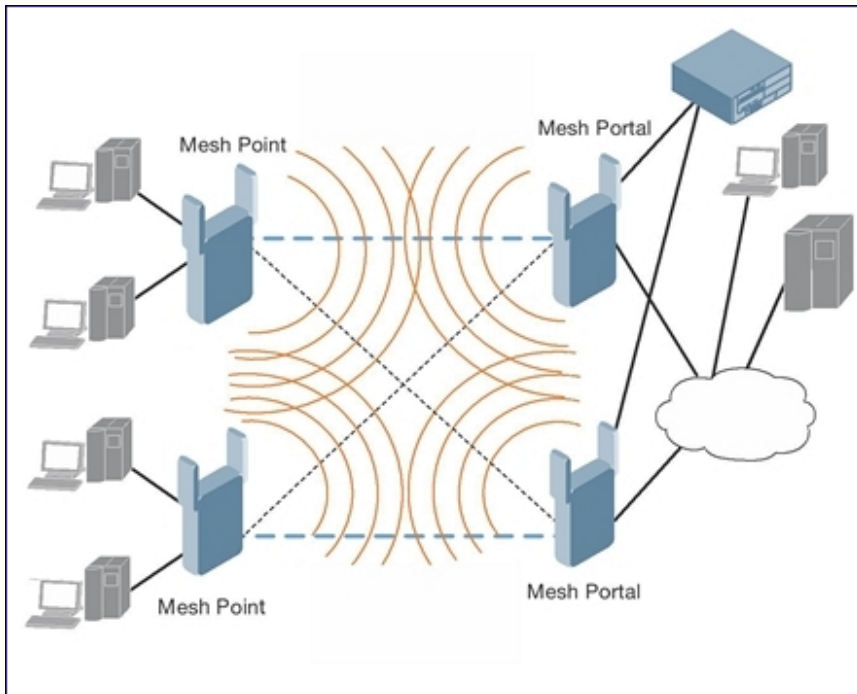

Planning a WLAN According to Your Specifications

Review the following steps to create a building model and plan the WLAN for your model.

Task Overview

1. Gather information about your building's dimensions and floor plan.
2. Determine the level of coverage you want for your APs and AMs.
3. Create a new building and add its dimensions.
4. Enter the parameters of your AP coverage.
5. Enter the parameters of your AM coverage.
6. Add floors to your building and import the floor plans.
7. Define special areas.
8. Generate suggested AP and AM tables by executing the AP/AM Plan features.

Collecting Required Information

You should collect the following information before using RF Plan. Having this information readily available will expedite your planning efforts.

- Building dimensions
- Number of floors
- Distance between floors
- Number of users and number of users per AP
- Radio type(s)
- Overlap Factor

- Desired data rates for APs
- Desired monitoring rates for AMs
- Areas of your building(s) that you do not necessarily want coverage
- Areas of your building(s) where you do not want or cannot deploy an AP or AM
- Areas of your building(s) where you want to deploy an 802.11n Hotspot (Zone)
- Any area where you want to deploy a fixed AP or AM

Use the worksheets ([Table 132](#), [Table 133](#), and [Table 134](#)) to collect your information:

Table 132: Planning Worksheet - Building Dimensions

Building Dimensions
Height:
Width:
Number of Floors:
Number of Users:
Users per AP:
Radio Types:
AP Type:
Overlap Factor:
802.11a Desired Rate:
802.11n (HT) Support:
Use 40 MHz Channel Spacing:
802.11n Desired Rate:

Table 133: Planning Worksheet - AP Desired Rates (2.4 GHz Radio Properties)

AP Desired Rates (2.4 GHz Radio Properties)
802.11b/g Desired Rate:
802.11n (HT) Support:
Use 40 MHz Channel Spacing:
802.11n Desired Rate:

Table 134: *Planning Worksheet - AM Desired Rates*

AM Desired Rates
802.11b g:
802.11a:
Don't Care/Don't Deploy Areas
802.11n Hotspot (Zone) Areas



NOTE: If 802.11n (HT) support is enabled, the system will automatically define the 802.11a and/or 802.11b/g rate as applicable. For details, see "[Radio Properties \(Desired Rates and HT Support Options\)](#)" on page 802.

Working with Mesh Radio Profiles

The mesh radio profile determines many of the settings used by mesh nodes to establish mesh links and the path to the mesh portal, including the maximum number of children a mesh node can accept, and transmit rates for the 802.11a and 802.11g radios. The attributes of the mesh radio profile are applied to a mesh point upon receiving its configuration from the controller. You can configure multiple radio profiles; however, you select and deploy only *one* radio profile per AP group. Radio profiles, including the "default" profile, are not active until you provision your APs for mesh.

If you modify a currently provisioned and running radio profile, your changes take effect immediately. You do not reboot the controller or the AP.

Managing Mesh Profiles In the WebUI

Use the following procedures to define and manage mesh radio profiles using the WebUI.

Creating a New Profile

1. Navigate to the **Configuration > Wireless > AP Configuration** window. Select either the **AP Group** or **AP Specific** tab.
 - If you selected the **AP Group** tab, click the **Edit** button by the AP group name for which you want to configure the new mesh radio profile.
 - If you selected the **AP Specific** tab, click the **Edit** button by the AP for which you want to create the mesh radio profile.
2. In the Profiles list, expand the **Mesh** menu, then select **Mesh radio profile**.
3. In the **Profile Details** window pane, click the **Mesh radio profile** drop-down list and select **New**. Enter a new mesh radio profile name in the field to the right of the drop-down list. Y
4. Configure your desired mesh radio settings.

Mesh Radio profile configuration settings are divided into two tabs, **Basic** and **Advanced**. The **Basic** tab displays only those configuration settings that often need to be adjusted to suit a specific network. The **Advanced** tab shows all configuration settings, including settings that do not need frequent adjustment or should be kept at their default values. If you change a setting on one tab then click and display the other tab without saving your configuration, that setting revert sto its previous value. The basic and advanced profile settings are described in [Table 135](#).

Table 135: Mesh Radio Profile Configuration Parameters

Parameter	Description
Basic Mesh Radio Settings	
Link Threshold	<p>Use this setting to optimize operation of the link metric algorithm.</p> <p>Indicates the minimal RSSI value. If the RSSI value is below this threshold, the link may be considered a sub-threshold link. A sub-threshold link is one whose average RSSI value falls below the configured link threshold.</p> <p>If this occurs, the mesh node may try to find a better link on the same channel and cluster (only neighbors on the same channel are considered).</p> <p>Default: 12. The supported threshold is hardware dependent, with a practical range of 10–90.</p>
Advanced Mesh Radio Settings	
802.11a Transmit Rates	<p>Indicates the transmit rates for the 802.11a radio.</p> <p>The AP attempts to use the highest transmission rate to establish a mesh link. If a rate is unavailable, the AP goes through the list and uses the next highest rate.</p> <p>To modify transmit rates, do one of the following:</p> <ul style="list-style-type: none"> • In the WebUI, deselect (uncheck) a specific rate box to use fewer rates when establishing a mesh link. • In the CLI, enter the specific rates to use. <p>Default: All transmission rates are selected and used. If you do not select 802.11a or 802.11g transmit rates, all rates are selected by default when you click Apply.</p>
802.11g Transmit Rates	<p>Indicates the transmit rates for the 802.11g radio.</p> <p>The AP attempts to use the highest transmission rate to establish a mesh link. If a rate is unavailable, the AP goes through the list and uses the next highest rate.</p> <p>To modify transmit rates, do one of the following:</p> <ul style="list-style-type: none"> • In the WebUI, deselect (uncheck) a specific rate box to use fewer rates when establishing a mesh link. • In the CLI, enter the specific rates to use. <p>Default: All transmission rates are selected and used. If you do not select 802.11a or 802.11g transmit rates, all rates are selected by default when you click Apply.</p>
Allowed VLANs on Mesh Link	List the VLAN ID numbers of VLANs allowed on the mesh link.
BC/MC Rate Optimization	<p>Broadcast/Multicast Rate Optimization dynamically selects the rate for sending broadcast/multicast frames on any BSS. This feature determines the optimal rate for sending broadcast and multicast frames based on the lowest of the unicast rates across all associated clients.</p> <p>When the Multicast Rate Optimization feature is enabled, the controller scans the list of all associated stations in that BSS and finds the lowest transmission rate as indicated by the rate adaptation state for each station. If there are no associated stations in the BSS, it selects the lowest configured rate as the transmission rate for broadcast and multicast frames.</p> <p>This feature is enabled by default. Multicast Rate Optimization applies to broadcast and multicast frames only. 802.11 management frames are not affected by this feature and are transmitted at the lowest configured rate. When enabled, this setting dynamically adjusts the multicast rate to that of the slowest connected mesh child. Multicast frames are not sent if there are no mesh children.</p> <p>NOTE: This feature should only be enabled on a BSS where all associated stations are sending or receiving unicast data. If there is no unicast data to or from a particular station, then the rate adaptation state may not accurately reflect the current sustainable transmission rate for that station. This could result in a higher packet error rate for broadcast/multicast packets at that station.</p> <p>Default: Enabled.</p>
Heartbeat threshold	<p>Indicates the maximum number of heartbeat messages that can be lost between neighboring mesh nodes.</p> <p>Default: 10 missed heartbeats. The range is 1–255.</p>

Parameter	Description
Maximum Children	Indicates the maximum number of children a mesh node can accept. Default: 64 children. The range is 1–64.
Maximum Hop Count	Indicates the maximum hop count from the mesh portal. Default: 8 hops. The range is 1–32.
Mesh Private VLAN	A VLAN ID for control traffic between an remote mesh portal and mesh nodes. This VLAN ID must not be used for user traffic. Range: 0–4094. Default: 0 (disabled). For further information on configuring a remote mesh portal, see "Configuring Remote Mesh Portals (RMPs)" on page 471
Mesh Survivability	This feature is currently not supported and should only be enabled under the supervision of Dell technical support.
Metric algorithm	Use this setting to optimize operation of the link metric algorithm. Specifies the algorithm used by a mesh node to select its parent. Available options are: <ul style="list-style-type: none"> best-link-rssi—Selects the parent with the strongest RSSI, regardless of the number of children a potential parent has. distributed-tree-rssi—Selects the parent based on link-RSSI and node cost based on the number of children. This option evenly distributes the mesh points over high quality uplinks. Low quality uplinks are selected as a last resort. NOTE: Dell recommends using the default value. Default: distributed-tree-rssi.
Rate Optimization for delivering EAPOL frames and mesh echoes	When this parameter is enabled, EAPOL frames, mesh echo requests and echo responses are sent at a lower rate.
Reselection mode	Use this setting to optimize operation of the link metric algorithm. The reselection mode specifies the method a mesh node uses to find a better uplink to create a path to the mesh portal. Only neighbors on the same channel in the same mesh cluster are considered. Available options are: <ul style="list-style-type: none"> reselect-anytime—Mesh points using the reselect-anytime reselection mode perform a single topology readjustment scan within 9 minutes of startup and 4 minutes after a link is formed. If no better parent is found, the mesh point returns to its original parent. This initial scan evaluates more distant mesh points before closer mesh points, and incurs a dropout of 5–8 seconds for each mesh point. After the initial startup scan is completed, connected mesh nodes evaluate mesh links every 30 seconds. If a mesh node finds a better uplink, the mesh node connects to the new parent to create an improved path to the mesh portal. reselect-never—Connected mesh nodes do not evaluate other mesh links to create an improved path to the mesh portal. startup-subthreshold—Mesh points using the startup-subthreshold reselection mode perform a single topology readjustment scan within 9 minutes of startup and 4 minutes after a link is formed. If no better parent is found, the mesh point returns to its original parent. This initial startup scan evaluates more distant mesh points before closer mesh points, and incurs a dropout of 5–8 seconds for each mesh point. After that time, each mesh node evaluates alternative links if the existing uplink falls below the configured threshold level (the link becomes a sub-threshold link). Dell recommends using this default startup-subthreshold value. subthreshold-only—Connected mesh nodes evaluate alternative links only if the existing uplink becomes a sub-threshold link. NOTE: Starting with ArubaOS 3.4.1, if a mesh point using the startup-subthreshold or subthreshold-only mode reselects a more distant parent because its original, closer parent falls below the acceptable threshold, then as long as that mesh point is connected to that more distant parent, it seeks to reselect a

Parameter	Description
	parent at the earlier, shorter distance (or less) with good link quality. For example, if a mesh point disconnects from a mesh parent 2 hops away and subsequently reconnects to a mesh parent 3 hops away, then the mesh point continues to seek a connection to a mesh parent with both an acceptable link quality and a distance of two hops or less, even if the more distant parent also has an acceptable link quality.
Retry Limit	Indicates the number of times a mesh node can re-send a packet. Default: 4 times. The range is 0– 15.
RTS Threshold	Defines the packet size sent by mesh nodes. Mesh nodes transmitting frames larger than this threshold must issue request to send (RTS) and wait for other mesh nodes to respond with clear to send (CTS) to begin transmission. This helps prevent mid-air collisions. Default: 2,333 bytes. The range is 256– 2,346.

- Click **Apply**. The profile name appears in the Mesh Radio Profile list with your configured settings.
If you configure this for the AP group, this profile also becomes the selected radio profile used by the mesh portal for your mesh network.

Assigning a Profile to a Mesh AP or AP Group

- Navigate to the **Configuration > Wireless > AP Configuration** window. Select either the **AP Group** or **AP Specific** tab.
 - If you selected **AP Group**, click the **Edit** button by the AP group to which you want to assign a new mesh radio profile.
 - If you selected **AP Specific**, click the **Edit** button by the AP to which you want to assign a new mesh radio profile.
- Under the Profiles list, expand the **Mesh** menu, then select **Mesh radio profile**.
- In the **Profile Details** window pane, click the **Mesh radio profile** drop-down list and select the desired mesh radio profile from the list.
- Click **Apply**. The profile name appears in the Mesh Radio Profile list with your configured settings. If you configure this for the AP group, this profile also becomes the selected radio profile used by the mesh portal for your mesh network.

Editing a Profile

- Navigate to the **Configuration > Wireless > AP Configuration** window. Select either the **AP Group** or **AP Specific** tab.
 - If you selected the **AP Group** tab, click the **Edit** button by the AP group name with the profile you want to edit.
 - If you selected the **AP Specific** tab, click the **Edit** button by the AP with the profile you want to edit.
- In the Profiles list, expand the **Mesh** menu, then select **Mesh radio profile**.
- In the **Profile Details** window pane, click the **Mesh radio profile** drop-down list and select the name of the profile you want to edit.
- Change the mesh radio settings as desired. [Table 135](#) describes the parameters you can configure in the mesh radio profile.
- Click **Apply** to save your changes.

Deleting a Profile

Use the following procedure to delete an existing mesh radio profile using the WebUI. You can delete a mesh radio profile only if no other APs or AP groups are using that profile.

1. Navigate to the **Configuration > Advanced Services > All Profiles** window.
2. Expand the **Mesh** menu, then select **Mesh radio profile**. A list of mesh radio profiles appears in the **Profile Details** window pane.
3. Click the **Delete** button by the name of the profile you want to delete.

Managing Mesh Profiles In the CLI

You must be in config mode to create, modify or delete a mesh radio profile using the CLI. Specify an existing mesh profile with the <profile-name> parameter to modify an existing profile, or enter a new name to create an entirely new profile.

Creating or Modifying a Profile

Configuration details and any default values for each of these parameters are described in [Table 135](#). If you do not specify a parameter for a new profile, that profile uses the default value for that parameter. Put the **no** option before any parameter to remove the current value for that parameter and return it to its default setting. Enter **exit** to leave the mesh radio profile mode.

```
(host) (config) #ap mesh-radio-profile <profile-name>
  a-tx-rates
  allowed-vlans
  children <children>
  clone <source-profile-name>
  eapol-rate-opt
  g-tx-rates [1|2|5|6|9|11|12|18|24|36|48|54]
  heartbeat-threshold <count>
  hop-count <hop-count>
  link-threshold <count>
  max-retries <max-retries>
  mesh-ht-ssid-profile
  mesh-mcast-opt
  mesh-survivability
  metric-algorithm {best-link-rssi|distributed-tree-rssi}
  mpv <vlan-id>
  no
  reselection-mode
  rts-threshold <rts-threshold>
```

You can also create a new mesh radio profile by copying the settings of an existing profile using the clone parameter. Using the clone command to create a new profile makes it easier to keep constant attributes in common within multiple profiles.

```
(host) (config) #ap mesh-radio-profile <profile-name> clone <source-profile-name>
```

Viewing Profile Settings

To view a complete list of mesh radio profiles and their status:

```
(host) (config) #show ap mesh-radio-profile
```

To view the settings of a specific mesh radio profile:

```
(host) (config) #show ap mesh-radio-profile <name>
```

Assigning a Profile to an AP Group

To associate a mesh radio profile with an AP group, use the following commands. When you add the mesh cluster profile to the AP group, you must also define the cluster priority.

```
(host) (config) #ap-group <group>
    mesh-radio-profile <profile-name> priority <priority>
```

To associate a mesh radio profile with an individual AP:

```
(host) (config) #ap-name <name>
    mesh-radio-profile <profile-name> priority <priority>
```

The following examples assign the mesh cluster profiles **cluster1** and **cluster2** to two different AP groups. In the AP group **group1**, **cluster1** has a priority of 5, and **cluster2** has a priority of 10, so **cluster1** has the higher priority. In the AP group **group2**, **cluster1** has a priority of 10, and **cluster2** has a priority of 5, so **cluster5** has the higher priority.

```
(host) (config) #group2-cluster1 has a priority of 10, and cluster2 has a priority of 5.
```

```
(host) (config) #ap-group group1
    mesh-cluster-profile cluster1 priority 5
    mesh-cluster-profile cluster2 priority 10
```

```
(host) (config) #ap-group2
    mesh-cluster-profile cluster1 priority 10
    mesh-cluster-profile cluster2 priority 5
```

Deleting a Mesh Radio Profile

If no AP or AP group is using a mesh radio profile, you can delete that profile using the **no** parameter:

```
no ap mesh-radio-profile <profile-name>
```

Working with Mesh High Throughput SSID Profiles

The mesh high-throughput SSID profile defines settings unique to 802.11n-capable, high-throughput APs. If none of the APs in your mesh deployment are 802.11n-capable APs, you do not need to configure a high-throughput SSID profile.

If you modify a currently provisioned and running high-throughput SSID profile, your changes take effect immediately. You do not reboot the controller or the AP.

Managing Profiles In the WebUI

Use the following procedures to manage your high-throughput SSID profiles using the WebUI.

Creating a Profile

To create a high-throughput SSID profile:

1. Navigate to the **Configuration > Wireless > AP Configuration** window. Select either the **AP Group** or **AP Specific** tab.
 - If you selected **AP Group**, click the **Edit** button by the AP group for which you want to create the new high-throughput SSID profile.
 - If you selected **AP Specific**, click **Edit** button by the AP for which you want to create the new high-throughput SSID profile.
2. In the Profiles list, expand the **Mesh** menu, then select **MeshHigh-throughput SSID profile**.
3. In the **Profile Details** window pane, click the **Mesh High-throughput SSID profile** drop-down list and select **NEW**.
4. Enter a name for the new profile.

- Configure the mesh high-throughput SSID parameters described in [Table 136](#). The Mesh High-Throughput SSID Profile configuration settings are divided into two tabs, **Basic** and **Advanced**. The **Basic** tab displays only those configuration settings that often need to be adjusted to suit a specific network. The **Advanced** tab shows all configuration settings, including settings that do not need frequent adjustment or should be kept at their default values. If you change a setting on one tab then click and display the other tab without saving your configuration, that setting reverts to its previous value.
- Click **Apply** to save your settings. The profile name appears in the Mesh High-throughput SSID Profile list with your configured settings.

Table 136: Mesh High-Throughput SSID Profile Configuration Parameters

Parameter	Description
Basic Mesh High-Throughput SSID Profile Settings	
40 MHz channel usage	Enable or disable the use of 40 MHz channels. This parameter is enabled by default.
High-throughput Enable (SSID)	Enable or disable high-throughput (802.11n) features on the SSID. This parameter is enabled by default.
Advanced Mesh High-Throughput SSID Profile Settings	
Temporal Diversity Enable	When a client is not responding to 802.11 packets, the AP will launch two hardware retries. If this option is enabled and hardware retries are not successful, then the AP will launch then software retries.
BA AMSDU Enable	Enable/Disable Receive AMSDU in BA negotiation.
Legacy stations	Allow or disallow associations from legacy (non-HT) stations. By default, this parameter is enabled (legacy stations are allowed).
Low-density Parity Check	If enabled, the AP advertises Low-density Parity Check (LDPC) support LDPC improves data transmission over radio channels with high levels of background noise. (For W-AP130 Series only)
Maximum number of spatial streams usable for STBC reception	Controls the maximum number of spatial streams usable for STBC reception. 0 disables STBC reception, 1 uses STBC for MCS 0-7. Higher MCS values are not supported. (Supported on the W-AP90 series, W-AP130 Series, W-AP68, W-AP175 Series and W-AP105 only. The configured value adjusts based on AP capabilities.)
Maximum number of spatial streams usable for STBC transmission.	Controls the maximum number of spatial streams usable for STBC transmission. 0 disables STBC transmission, 1 uses STBC for MCS 0-7. Higher MCS values are not supported. (Supported on W-AP90 series, W-AP175 Series, W-AP130 Series and W-AP105 only. The configured value adjusts based on AP capabilities.)
MPDU Aggregation	Enable or disable MAC protocol data unit (MPDU) aggregation. High-throughput APs are able to send aggregated MAC protocol data units (MDPUs), which allow an AP to receive a single block acknowledgment instead of multiple ACK signals. This option, which is enabled by default, reduces network traffic overhead by effectively eliminating the need to initiate a new transfer for every MPDU.
Max received A-MPDU size	Maximum size of a received aggregate MPDU, in bytes. Allowed values: 8191, 16383, 32767, 65535.
Max transmitted A-MPDU size	Maximum size of a transmitted aggregate MPDU, in bytes. Range: 1576–65535
Min MPDU start spacing	Minimum time between the start of adjacent MPDUs within an aggregate MPDU, in

Parameter	Description
	microseconds. Allowed values: 0 (No restriction on MDPU start spacing), .25 µsec, .5 µsec, 1 µsec, 2 µsec, 4 µsec.
Short guard interval in 20 MHz mode	<p>Enable or disable use of short (400ns) guard interval in 20 MHz mode. This parameter is enabled by default.</p> <p>A guard interval is a period of time between transmissions that allows reflections from the previous data transmission to settle before an AP transmits data again. An AP identifies any signal content received inside this interval as unwanted inter-symbol interference, and rejects that data. The 802.11n standard specifies two guard intervals: 400ns (short) and 800ns (long). Enabling a short guard interval can decrease network overhead by reducing unnecessary idle time on each AP. Some outdoor deployments, may, however require a longer guard interval. If the short guard interval does not allow enough time for reflections to settle in your mesh deployment, inter-symbol interference values may increase and degrade throughput.</p>
Short guard interval in 40 MHz mode	<p>Enable or disable use of short (400ns) guard interval in 40 MHz mode. This parameter is enabled by default.</p> <p>A guard interval is a period of time between transmissions that allows reflections from the previous data transmission to settle before an AP transmits data again. An AP identifies any signal content received inside this interval as unwanted inter-symbol interference, and rejects that data. The 802.11n standard specifies two guard intervals: 400ns (short) and 800ns (long). Enabling a short guard interval can decrease network overhead by reducing unnecessary idle time on each AP. Some outdoor deployments, may, however require a longer guard interval. If the short guard interval does not allow enough time for reflections to settle in your mesh deployment, inter-symbol interference values may increase and degrade throughput.</p>
Supported MCS set	<p>A list of Modulation Coding Scheme (MCS) values or ranges of values to be supported on this SSID. The MCS you choose determines the channel width (20MHz vs. 40MHz) and the number of spatial streams used by the mesh node.</p> <p>The default value is 1–23; the complete set of supported values. To specify a smaller range of values, enter a hyphen between the lower and upper values. To specify a series of different values, separate each value with a comma.</p> <p>Examples: 2–10 1,3,6,9,12 Range: 0–23.</p>

Assigning a Profile to an AP Group

- Navigate to the **Configuration > Wireless > AP Configuration** window. Select either the **AP Group** or **AP Specific** tab.
 - If you selected **AP Group**, click the **Edit** button by the AP group name to which you want to assign a new high-throughput SSID profile.
 - If you selected **AP Specific**, click the **Edit** button by the AP to which you want to assign a new high-throughput SSID profile
- Under the Profiles list, expand the **Mesh** menu, then select **Mesh High-throughput SSID profile**.
- In the **Profile Details** window pane, click the **Mesh High-throughput SSID profile** drop-down list and select the desired profile from the list.
- Click **Apply**. The profile name appears in the Mesh High-throughput SSID Profile list with your configured settings. If you configure this for the AP group, this profile also becomes the selected high-throughput SSID profile used by the mesh portal for your mesh network.

Editing a Profile

1. Navigate to the **Configuration > Wireless > AP Configuration** window. Select either the **AP Group** or **AP Specific** tab.
 - If you selected the **AP Group** tab, click the **Edit** button by the AP group name with the profile you want to edit.
 - If you selected the **AP Specific** tab, click the **Edit** button by the AP with the profile you want to edit.
2. In the Profiles list, expand the Meshmenu, then select **Mesh High-throughput SSID profile**.
3. In the **Profile Details** window pane, click the **Mesh High-throughput SSID profile** drop-down list and select the name of the profile you want to edit.
4. Change the settings as desired. [Table 136](#) describes the parameters you can configure in this profile.
5. Click **Apply** to save your changes.

Deleting a Profile

You can delete a mesh high-throughput SSID profile only if no APs or AP groups are associated with that profile.

1. Navigate to the **Configuration > Advanced Services > All Profiles** window.
2. Expand the Meshmenu, then select **Mesh High-throughput SSID profile**. A list of high-throughput SSID profiles appears in the **Profile Details** window pane.
3. Click the **Delete** button by the name of the profile you want to delete.

Managing Profiles In the CLI

You must be in config mode to create, modify or delete a mesh radio profile using the CLI. Specify an existing high-throughput SSID profile with the <profile-name> parameter to modify an existing profile, or enter a new name to create an entirely new profile.

Creating or Modifying a Profile

Configuration details and any default values for each of these parameters are described in [Table 136](#). If you do not specify a parameter for a new profile, that profile uses the default value for that parameter. Put the **no** option before any parameter to remove the current value for that parameter and return it to its default setting. Enter **exit** to leave the high-throughput radio profile mode

```
(host) (config) #ap mesh-ht-ssid-profile <profile-name>
  40MHz-enable
  clone
  high-throughput-enable
  ldpc
  legacy-stations
  max-rx-a-mpdu-size
  max-tx-a-mpdu-size
  min-mpdu-start-spacing
  mpdu-agg
  no
  short-guard-intvl-20mhz
  short-guard-intvl-40mhz
  stbc-rx-streams
  stbc-tx-streams
  supported-mcs-set
  temporal-diversity
```

You can also create a new mesh high-throughput SSID profile by copying the settings of an existing profile using the clone parameter. Using the **clone** command to create a new profile makes it easier to keep constant attributes in common within multiple profiles.

```
ap mesh-ht-ssid-profile <profile-name> clone <source-profile-name>
```

Assigning a Profile to an AP Group

To associate a mesh high-throughput SSID profile with an AP group:

```
(host) (config) #ap-group <group> mesh-ht-ssid-profile <profile-name>
```

To associate a mesh radio profile with an individual AP:

```
(host) (config) #ap-name <name> mesh-ht-ssid-profile <profile-name>
```

Viewing High-throughput SSID Settings

To view a complete list of high-throughput profiles and their status:

```
(host) (config) #show ap mesh-ht-ssid-profile
```

To view the settings of a specific high-throughput profile:

```
(host) (config) #show ap mesh-ht-ssid-profile <profile-name>
```

Deleting a Profile

If no AP or AP group is using a mesh high-throughput SSID profile, you can delete that profile using the **no** parameter:

```
no ap mesh-ht-ssid-profile <profile-name>
```

Understanding Mesh Cluster Profiles

The mesh cluster configuration gets pushed from the controller to the mesh portal and the other mesh points, which allows them to inherit the characteristics of the mesh cluster of which they are a member. Mesh nodes are grouped according to a mesh cluster profile that contains the MSSID, authentication methods, security credentials, and cluster priority. Cluster profiles, including the “default” profile, are not applied until you provision your APs for mesh.

Since the mesh cluster profile provides the framework of the mesh network, you must define and configure the mesh cluster profile before configuring an AP to operate as a mesh node. You can use either the “default” cluster profile or create your own. If you find it necessary to define more than one mesh cluster profile, you must assign priorities to each profile to allow the Mesh AP group to identify the primary and backup mesh cluster profile(s). The primary mesh cluster profile and each backup mesh cluster profile must be configured to use the same RF channel. The APs may not provision correctly if they are assigned to a backup mesh cluster profile with a different RF channel than the primary mesh cluster profile.

If the mesh cluster profile is unavailable, the mesh node can revert to the recovery profile to bring-up the mesh network until the cluster profile is available. You can also exclude one or more mesh cluster profiles from an individual AP—this prevents a mesh cluster profile defined at the AP group level from being applied to a specific AP.

Do not delete or modify mesh cluster profiles once you use them to provision mesh nodes. You can recover the mesh point if the original cluster profile is still available. Dell recommends creating a new mesh cluster profile if needed. If you modify any mesh cluster setting, you must reprovision your AP for the changes to take effect (this also causes the AP to automatically reboot). See “Provisioning Mesh Nodes” for more information.

Deployments with Multiple Mesh Cluster Profiles

If you configure multiple cluster profiles with different cluster priorities, you manually override the link metric algorithm because the priority takes precedence over the path cost. In this scenario, the mesh portal uses the profile with the highest priority to bring-up the mesh network. The mesh portal stores and advertises that one profile to neighboring mesh nodes to build the mesh network. This profile is known as the “primary” cluster profile. Mesh

points, in contrast, go through the list of configured mesh cluster profiles in order of priority to find the profile being advertised by the mesh portal. Once the primary profile has been identified, the other profiles are considered “backup” cluster profiles. Use this deployment if you want to enforce a particular mesh topology rather than allowing the link metric algorithm to determine the topology.

For this scenario, do the following:

- Configure multiple mesh cluster profiles with different priorities. The primary cluster profile has a lower priority number, which gives it a higher priority.
- Configure the mesh radio profile.
- Create an AP group for 802.11a radios and 802.11g radios
- Configure the 802.11a or 802.11g RF management profiles for each AP group.
- If your deployment includes high-throughput APs, configure the mesh high-throughput SSID profile. The mesh radio profile uses the default high-throughput SSID profile unless you specifically configure the mesh radio profile to use a different high-throughput SSID profile
- Create an AP group for each 802.11a channel.

If a mesh link breaks or the primary cluster profile is unavailable, mesh nodes use the highest priority backup cluster profile to re-establish the uplink or check for parents in the backup profiles. If these profiles are unavailable, the mesh node can revert to the recovery profile to bring up the mesh network until a cluster profile is available. For a sample configuration, see “show ap mesh topology”.

Managing Mesh Cluster Profiles In the WebUI

Use the following procedures to define and manage mesh cluster profiles using the WebUI.

Creating a Profile

1. Navigate to the **Configuration > Wireless > AP Configuration** window. Select the **AP Group** or **AP Specific** tab.
 - If you selected **AP Group**, click the **Edit** button by the AP group name for which you want to create the new mesh cluster profile.
 - If you selected **AP Specific**, click the **Edit** button by AP for which you want to create the new mesh cluster profile.
2. In the Profiles list, expand the Meshmenu, then select **Mesh Cluster profile**.
3. In the **Profile Details** window pane, click the **Add a profile** drop-down list and select **NEW**.
4. Enter a name for the new profile.
5. Configure the mesh cluster settings described in [Table 137](#), then click **Apply** to save your settings.

Table 137: Mesh Cluster Profile Configuration Parameters

Parameter	Description
Profile Name	Name of the mesh cluster profile. The name must be 1–63 characters. Default: Mesh cluster profile named “default.”
Cluster Name	Indicates the mesh cluster name. The name can have a maximum of 32 characters, and is used as the MSSID for the mesh cluster. When you first create a new mesh cluster profile, the profile uses the default cluster name “Dell-mesh”. Use the Cluster Name parameter to define a new, unique MSSID before you assign APs or AP groups to the mesh cluster profile. NOTE: If you want a mesh cluster to use WPA2-PSK-AES encryption, do not use spaces in the mesh cluster name, as this may cause errors in mesh points associated with that mesh cluster. To view existing mesh cluster profiles, use the CLI command: show ap mesh-cluster-profile.

Parameter	Description
	A mesh portal chooses the best cluster profile and provisions it for use. A mesh point can have a maximum of 16 cluster profiles. Default: Mesh cluster named "Dell-mesh."
RF Band	Indicates the band for mesh operation for multiband radios. Select a or g. Important: If you create more than one mesh cluster profile for an AP or AP group, each mesh cluster profile must use the same band.
Encryption	Configures the data encryption, which can be either opensystem (no authentication or encryption) or wpa2-psk-aes (WPA2 with AES encryption using a preshared key). Dell recommends selecting wpa2-psk-aes and using the wpa-passphrase parameter to select a passphrase. Keep the passphrase in a safe place. Default: opensystem.
WPA Hexkey	Configures a WPA pre-shared key. This key must be 64 hexadecimal characters
WPA Passphrase	Sets the WPA password that generates the PSK. The passphrase must be between 8–63 characters, inclusive.
Priority	Indicates the priority of the cluster profile. The mesh cluster priority determines the order by which the mesh cluster profiles are used. This allows you, rather than the link metric algorithm, to control the network topology by defining the cluster profiles to use if one becomes unavailable Specify the cluster priority when creating a new profile or adding an existing profile to a mesh cluster. If more than two mesh cluster profiles are configured, mesh points use the priority numbers to identify primary and backup profile(s). NOTE: The lower the number, the higher the priority. Therefore, the profile with the lowest number is the primary profile. Each profile must use a unique priority value to ensure a deterministic mesh path. Default: 1 for the "default" mesh cluster profile and all user-created cluster profiles. The recovery profile has a priority of 255 (this is not a user-configured profile). The range is 1–16.
Cluster Name	Indicates the mesh cluster name. The name can have a maximum of 32 characters, which is used as the MSSID. When you create a new cluster profile, it is a member of the "Dell-mesh" cluster. NOTE: Each mesh cluster profile should have a unique MSSID. Configure a new MSSID before you apply the mesh cluster profile. To view existing mesh cluster profiles, use the command: show ap mesh-cluster-profile. A mesh portal chooses the best cluster profile and provisions it for use. A mesh point can have a maximum of 16 cluster profiles. Default: Mesh cluster named "Dell-mesh."
RF Band	Indicates the band for mesh operation for multiband radios. Select a or g.

Associating a Profile to Mesh APs

Use the following procedure to associate a mesh cluster profile to a group of mesh APs or an individual mesh AP using the WebUI. If you configure multiple cluster profiles with different cluster priorities, you manually override the link metric algorithm because the priority takes precedence over the path cost. In this scenario, the mesh portal uses the profile with the highest priority to bring-up the mesh network.

- Navigate to the **Configuration > Wireless > AP Configuration** window. Select either the **AP Group** or **AP Specific** tab.
 - If you selected **AP Group**, click the **Edit** button by the AP group name to which you want to assign a new mesh cluster profile.
 - If you selected **AP Specific**, click the **Edit** button by the AP to which you want to assign a new mesh cluster profile
- Under the Profiles list, expand the Meshmenu, then select **Mesh Cluster profile**.

3. In the **Profile Details** window pane, click the **Mesh Cluster profile** drop-down list select **New**.
 - To add an existing mesh cluster profile to the selected AP group, click the **Add a profile** drop-down list and select a new profile name from the list.
 - To create a new mesh cluster profile to the selected AP group, click the **Add a profile** drop-down list and select **NEW**. Enter a name for the new mesh cluster profile.
4. Click the **using priority** drop-down list to select a priority for the mesh cluster profile. The lower the number, the higher the priority.
5. Click **Add** to add the mesh cluster profile to the AP group.
6. Click **Apply**. The profile name appears in the mesh cluster profile list with your configured settings. If you configure this for the AP group, this profile also becomes the mesh cluster profile used by the mesh portal for your mesh network.

Editing a Profile

If you modify any mesh cluster profile setting, you must reprovision your AP. For example, if you change the priority of a cluster profile from 5 to 2, you must reprovision the AP before you can assign priority 5 to another cluster profile. Reprovisioning the AP causes it to automatically reboot. For more information, see “Provisioning Mesh Nodes”.

1. Navigate to the **Configuration > Wireless > AP Configuration** window. Select either the **AP Group** or **AP Specific** tab.
 - If you selected the **AP Group** tab, click the **Edit** button by the AP group name with the profile you want to edit.
 - If you selected the **AP Specific** tab, click the **Edit** button by the AP with the profile you want to edit.
2. In the Profiles list, expand the **Mesh** menu, then select **Mesh Cluster profile**.
3. In the **Profile Details** window pane, click the **Mesh Cluster profile** drop-down list and select the name of the profile you want to edit.
4. Change the desired mesh radio settings as desired. [Table 136](#) describes the parameters you can configure in the mesh high-throughput SSID profile.

NOTE: A mesh cluster profile configured with **wpa2-psk-aes encryption** must have a defined WPA hexkey or a WPA passphrase (or both). If you have configured one encryption type but not the other, and want switch from a hexkey to a passphrase or vice versa, you must add the new encryption type, click **Apply**, then remove the encryption type you no longer want and click **Apply** again. You cannot delete one encryption type and add a different type in a single step.



5. Click **Apply** to save your changes.

Deleting a Mesh Cluster Profile

You can delete a mesh cluster profile only if no APs or AP groups are associated with that profile.

1. Navigate to the **Configuration > Advanced Services > All Profiles** window.
2. Expand the **Mesh** menu, then select **Mesh Cluster profile**. A list of high-throughput SSID profiles appears in the *Profile Details* window pane.
3. Click the **Delete** button by the name of the profile you want to delete.

Managing Mesh Cluster Profiles In the CLI

You must be in config mode to create, modify or delete a mesh cluster profile using the CLI. Specify an existing mesh cluster profile with the <profile-name> parameter to modify an existing profile, or enter a new name to create an entirely new profile.

Configuration details and any default values for each of these parameters are described in [Table 137](#). If you do not specify a parameter for a new profile, that profile uses the default value for that parameter.

Use the **no** option before any parameter to remove the current value for that parameter and return it to its default setting. Enter **exit** to leave the mesh cluster profile mode.

```
(host) (config) #ap mesh-cluster-profile <profile>
  clone <profile>
  cluster <name>
  no ...
  opmode [opensystem | wpa2-psk-aes]
  rf-band {a | g}
  wpa-hexkey <wpa-hexkey>
  wpa-passphrase <wpa-passphrase>
```

The following examples create and configure the mesh cluster profiles **cluster1** and **cluster2**.

```
(host) (config) #ap mesh-cluster-profile cluster1
  cluster corporate
  opmode wpa2-psk-aes
  wpa-passphrase mesh_123
  rf-band a
```

```
(host) (config) #ap mesh-cluster-profile cluster2
  cluster corporate
  opmode wpa2-psk-aes
  wpa-passphrase mesh_123rf-band a
```

You can also create a new mesh radio profile by copying the settings of an existing profile using the clone parameter. Using the clone command to create a new profile makes it easier to keep constant attributes in common within multiple profiles.

```
(host) (config) #ap mesh-cluster-profile <profile-name> clone <source-profile-name>
```

Viewing Mesh Cluster Profile Settings

To view a complete list of mesh cluster profiles and their status:

```
(host) (config) #show mesh-cluster-profile
```

To view the settings of a specific mesh cluster profile:

```
(host) (config) #show ap mesh-cluster-profile <profile-name>
```

Associating Mesh Cluster Profiles

The following commands associate a mesh cluster profile to an AP group or an individual AP. For deployments with multiple mesh clusters, you must also configure also the profile's priority. Remember, the lower the priority number, the high the priority. The mesh cluster priority determines the order by which the mesh cluster profiles are used. This allows you, rather than the link metric algorithm, to control the network topology by defining the cluster profiles to use if one becomes unavailable.

To associate a mesh cluster profile to an AP group in a single-cluster deployment:

```
(host) (config) #ap-group <group> mesh-cluster-profile <profile-name>
```

To associate a mesh cluster profile to an individual AP in a single-cluster deployment:

```
(host) (config) #ap-name <name> mesh-cluster-profile <profile-name>
```

To associate a mesh cluster profile to an AP group in a multiple-cluster deployment:

```
(host) (config) #ap-group <group> mesh-cluster-profile <profile-name> priority <priority>
```

To associate a mesh cluster profile to an individual AP in a multiple-cluster deployment, use the command

```
(host) (config) #ap-name <name>
```

```
mesh-cluster-profile <profile-name> priority <priority>
```

Example:

```
(host) (config) #ap-group group1
    mesh-cluster-profile cluster1 priority 5
    mesh-cluster-profile cluster2 priority 10
(host) (config) #ap-group2
    mesh-cluster-profile cluster1 priority 10
    mesh-cluster-profile cluster2 priority 5
    mesh-radio-profile channel2
```

Excluding a Mesh Cluster Profile from a Mesh Node

To exclude a specific mesh cluster profile from an AP:

```
(host) (config) #ap-name <name> exclude-mesh-cluster-profile-ap <profile-name>
```

Deleting a Mesh Cluster Profile

If no AP or is using a mesh cluster profile, you can delete that profile using the **no** parameter:

```
(host) (config) #no ap mesh-cluster-profile <profile-name>
```

Configuring Ethernet Ports for Mesh

If you are using mesh to join multiple Ethernet LANs, configure and enable bridging on the mesh point Ethernet port. This section describes how to configure Ethernet ports for bridging or secure jack operation using the wired AP profile. The wired AP profile controls the configuration of the Ethernet port(s) on your AP.

NOTE: Mesh nodes only support bridge mode and tunnel mode on their wired ports (enet0 or enet1). Split tunnel mode is not supported. Use bridge mode to configure bridging on the mesh point Ethernet port. Use tunnel mode to configure secure jack operation on the mesh node Ethernet port.

When configuring the Ethernet ports on the W-AP130 Series or W-AP120 Series, note the following requirements:

- If the AP is configured as a mesh portal:
 - Connect enet0 to the controller to obtain an IP address. The wired AP profile controls enet1.
 - Only enet1 supports secure jack operation.
- If the AP is configured as a mesh point, the same wired AP profile controls both enet0 and enet1.

Configuring Bridging on the Ethernet Port

Use the following procedure to configure bridging on the Ethernet port via the WebUI.

1. Navigate to the **Configuration > Wireless > AP Configuration > AP Group** window.
2. Click the **Edit** button by the AP group name with the wired ap profile you want to edit.
3. Under the Profiles list, expand the **AP** menu, then select **Wired AP profile**. The settings for the currently selected wired AP profile appear.

You can use a different wired AP profile by selecting a profile from the **Wired AP profile** drop-down list.

4. Under Profile Details, do the following:
 - a. Select the **Wired AP enable** check box. This option is not selected by default.
 - b. From the **Forward mode** drop-down list, select **bridge**.
 - c. Optionally, from the **Switchport mode** drop-down list, select **access** or **trunk**. These options only apply to bridge mode configurations.

- Access mode forwards untagged packets received on the port to the controller and they appear on the configured access mode VLAN. Tagged packets are dropped. All packets received from the controller and sent via this port are untagged. Define the access mode VLAN in the **Access mode VLAN** field.
- Trunk mode contains a list of allowed VLANs. Any packet received on the port that is tagged with an allowed VLAN is forwarded to the controller. Untagged packets are forwarded to the controller on the configured Native VLAN. Packets received from the controller and sent out the port remain tagged unless the tag value in the packet is the Native VLAN, in which case the tag is removed. Define the Native VLAN in the **Trunk mode native VLAN** field and the other allowed VLANs in the **Trunk mode allowed VLANs** field.

d. Optionally, select **Trusted** to configure this as a trusted port.

5. Click **Apply**.

Use the following commands to configure ethernet port bridging via the CLI.

```
(host) (config) #ap wired-ap-profile <profile>
    forward-mode bridge
    wired-ap-enable
```

Optionally, you can configure the following wired AP profile settings:

```
(host) (config) #ap wired-ap-profile <profile>
    switchport mode {access | trunk}
    switchport access vlan <vlan>
    switchport trunk native vlan <vlan>
    switchport trunk allowed vlan <vlan>
    trusted
```

Configuring Ethernet Ports for Secure Jack Operation

You can configure the Ethernet port(s) on mesh nodes to operate in tunnel mode. Known as secure jack operation for mesh, this configuration allows Ethernet frames coming into the specified wired interface to be generic routing encapsulation (GRE) tunneled to the controller. Likewise, Ethernet frames coming from the tunnel are bridged to the corresponding wired interface. This allows an Ethernet port on the mesh node to appear as an Ethernet port on the controller separated by one or more Layer-3 domains. You can also enable VLAN tagging.

Unlike secure jack on non-mesh APs, any mesh node configured for secure jack uses the mesh link, rather than enet0, to tunnel the frame to the controller.

When configuring mesh Ethernet ports for secure jack operation, note the following guidelines:

- Mesh points support secure jack on enet0 and enet1.
- Mesh portals only support secure jack on enet1. This function is only applicable to Dell APs that support a second Ethernet port and mesh, such as the W-AP130 Series and W-AP120 Series.

You configure secure jack operation in the wired AP profile.



NOTE: The parameters in the wired AP profile only apply to the wired AP interface to which they are applied. Two wired interfaces can have different parameter values.

In the WebUI

Use the following procedure to configure secure jack operation using the WebUI.

1. Navigate to the **Configuration > Wireless > AP Configuration > AP Group** window.
2. Click the **Edit** button by the AP group with the wired AP profile you want to edit.
3. Under the Profiles list, expand the **AP** menu, then select **Wired AP profile**. The settings for the currently selected wired AP profile appear.

You can use a different wired AP profile by selecting a profile from the **Wired AP profile** drop-down list.

4. In the Profile Details window pane, do the following:
 - a. Select the **Wired AP enable** check box. This option is not selected by default.
 - b. From the **Forward mode** drop-down list, select **tunnel**.
 - c. Optionally, select **Trusted** to configure this as a trusted port.
5. Click **Apply** to save your settings.

In the CLI

To configure secure jack operation using the command-line interface, access the CLI in config mode and issue the following commands:

```
(host) (config) #ap wired-ap-profile <profile>
    forward-mode tunnel
    wired-ap-enable
```

Optionally, you can configure the following wired AP profile settings:

```
(host) (config) #ap wired-ap-profile <profile>
    trusted
```

Extending the Life of a Mesh Network

To prevent your mesh network from going down if you experience a controller failure, modify the following settings in the AP system profile(s) used by mesh nodes to maintain the mesh network until the controller is available:

 NOTE: Dell recommends the default maximum request retries and bootstrap threshold settings for most mesh networks; however, if you must keep your mesh network alive, you can modify the settings as described in this section. The modified settings are not applicable if mesh portals are directly connected to the controller.

- **Maximum request retries**—Maximum number of times to retry AP-generated requests. The default is 10 times. If you must modify this setting, Dell recommends a value of 10,000.
- **Bootstrap threshold**—Number of consecutive missed heartbeats before the AP reboots. (Heartbeats are sent once per second.) The default is 9 missed heartbeats. If you must modify this setting, Dell recommends a value of 5,000.

When the controller comes back online, the affected mesh nodes (mesh portals and mesh points) rebootstrap; however, the mesh link is not affected and continues to be up.

In the WebUI

Use the following procedure to modify the AP system profile via the WebUI.

1. Navigate to the **Configuration > Wireless > AP Configuration > AP Group** window.
2. Click the **Edit** button by the AP group with the AP system profile you want to edit.
3. Under Profiles list, expand the AP menu, then select **AP system profile**. The settings for the currently selected AP system profile appear in the **Profile Details** window pane.
4. Make the following changes in the **Profile Details** window pane.
 - a. Change the **Maximum Request Retries** to 10000.
 - b. Change the **Bootstrap threshold** to 5000.
5. Click **Apply**.

In the CLI

To modify the AP system profile via the command-line interface, access the CLI in config mode and issue the following commands:

```
(host) (config) #ap system-profile <profile>
```

```
max-request-retries 10000
bootstrap-threshold 5000
```

Provisioning Mesh Nodes

Provisioning mesh nodes is similar to thin APs; however, there are some key differences. Thin APs establish a channel to the controller from which they receive the configuration for each radio interface. Mesh nodes, in contrast, get their radio interfaces up and running before making contact with the controller. This requires a minimum set of parameters from the AP group and mesh cluster that enables the mesh node to discover a neighbor to create a mesh link and subsequent channel with the controller. To do this, you must first configure mesh cluster profiles for each mesh node prior to deployment. See “Mesh Radio Profiles” for more information.

On each radio interface, you provision a mode of operation: mesh node or thin AP (access) mode. If you do not specify mesh, the AP operates in thin AP (access) mode. If you configure mesh, the AP is provisioned with a minimum of two mesh cluster profiles: the “default” mesh cluster profile and an emergency read-only recovery profile, as described in the section “Mesh Clusters”. If you create and select multiple mesh cluster profiles, the AP is provisioned with those as well. If you have a dual-radio AP and configure one radio for mesh and the other as a thin AP, each radio is provisioned as configured.

Each radio provisioned in mesh mode can operate in one of two roles: mesh portal or mesh point. You explicitly configure the role, as described in this section. This allows the AP to know whether it uses the mesh link (via the mesh point/mesh portal) or an Ethernet link to establish a connection to the controller.

During the provisioning process, mesh nodes look for a mesh profile that the AP group and AP name is a member of and stores that information in flash. If you have multiple cluster profiles, the mesh portal uses the best profile to bring-up the mesh network. Mesh points in contrast go through the list of mesh cluster profiles in order of priority to decide which profile to use to associate themselves with the network. In addition, when a mesh point is provisioned, the country code is sent to the AP from its AP name or AP group along with the mesh cluster profiles. Mesh nodes also learn the recovery profile, which is automatically generated by the master controller. If the other mesh cluster profiles are unavailable, mesh nodes use the recovery profile to establish a link to the master controller; data forwarding does not take place.

 NOTE: If you create a new mesh cluster profile for an existing deployment, you must re-provision the AP for the new profile to take effect. If you re-provision mesh nodes that are already operating, re-provision the most distant (highest hop count) mesh points first followed by the mesh portals. If you re-provision the mesh portal first, the mesh points may be unable to form a mesh link. Re-provisioning the AP causes it to automatically reboot. This may cause a disruption of service to the network.

This section describes the following topics:

- “Outdoor AP Parameters”
- “Provisioning Caveats”
- “Provisioning Mesh Nodes”

Outdoor AP Parameters

If you are using outdoor APs and planning an outdoor mesh deployment, you can enter the following outdoor parameters when provisioning the AP:

- Latitude and longitude coordinates of the AP. These location identifiers allow you to more easily locate the AP for inventory and troubleshooting purposes.
- Altitude, in meters, of the AP.
- Antenna bearing to determine horizontal coverage.
- Antenna angle for optimum antenna coverage.



NOTE: The above parameters apply to all outdoor APs, not just outdoor APs configured for mesh.

Provisioning Caveats

Remember the following when provisioning APs for mesh:

- You must provision the AP before you install it as a mesh node in a mesh deployment. To provision the AP, it must be physically connected to the local network or directly connected to the controller. When connected and powered on, the AP must also be able to obtain an IP address from a DHCP server on the local network or from the controller.
- Make sure the provisioned mesh nodes form a connected mesh network before physically deploying the APs. For more information, see “Verifying the Network”.
- In multi-controller networks, save your mesh cluster configuration before provisioning the mesh nodes. To save your configuration in the WebUI, at the top of any window click **Save Configuration**. To save your configuration in the CLI, use the command: `write memory`.
- If the same port on the controller is used to provision APs and provide PoE for mesh nodes, you must stop traffic from passing through that port after you provision the AP. To stop traffic, shut down (disable) the port either by using the CLI command `interface fastethernet <slot>/<port> shutdown`, or by following the procedure below.
 1. Navigate to the **Configuration > Network > Ports** window.
 2. Under **Port Selection**, click the port to configure.
 3. Under **Configure Selected Port**, deselect (uncheck) **Enable Port**.
 4. Make sure **Enable 802.3af Power Over Ethernet** is selected.
 5. Click **Apply**.

Provisioning Mesh Nodes

Reprovisioning the AP causes it to automatically reboot. The following procedures describe the process to provision a mesh portal or mesh node via the WebUI or CLI. (The easiest way to provision a mesh node is to use the Provisioning window in the WebUI.) To provision a remote mesh portal, see “Remote Mesh Portals”.

In the WebUI

1. Navigate to the **Configuration > Wireless > AP Installation > Provisioning** window. Select the AP to provision for mesh and click **Provision**.
2. In the **Master Discovery** section, set the Master IP address as the controller IP address.
3. In the **IP settings** section, select **Obtain IP Address Using DHCP**.
4. In the **AP List** section, do the following:
 - Configure the Mesh Role:
 - To configure the AP as the mesh portal, select **Mesh Portal**.
 - To configure the AP as a mesh point, select **Mesh Point**.
 - Configure the Outdoor Parameters, if needed. The following parameters are available only if configuring an outdoor AP:
 - Latitude coordinates (degrees, minutes, seconds, north or south)
 - Longitude coordinates (degrees, minutes, seconds, east or west)
 - Altitude (in meters)
 - Antenna bearing (horizontal coverage)

- Antenna tilt angle (optimum coverage)
5. Click **Apply and Reboot**. After the controller reboots, mesh cluster profiles are extracted from the AP group and the AP name.

In the CLI

When you use the command-line interface to reprovision a mesh node, you may also provision other AP settings. To provision a remote mesh portal, see “Remote Mesh Portals”.

Access the CLI in config mode and issue the following commands:

```
(host) (config) #provision-ap
  read-bootinfo ap-name <name>
  mesh-role {mesh-point|mesh-portal}
  reprovision ap-name <name>
```

If you are provisioning an outdoor AP, you can also configure the following parameters:

```
(host) (config) #provision-ap
  read-bootinfo ap-name <name>
  mesh-role {mesh-point|mesh-portal|remote-mesh-portal}
  a-ant-bearing <bearing>
  a-ant-tilt-angle <angle>
  g-ant-bearing <bearing>
  g-ant-tilt-angle <angle>
  altitude <altitude>
  latitude <location>
  longitude <location>
  reprovision ap-name <name>
```

Understanding the AP Boot Sequence

The section describes the boot sequence for mesh APs in detail. Depending on its configured role, the AP performs a slightly different boot sequence.

Booting the Mesh Portal

When the mesh portal boots, it recognizes that one radio is configured to operate as a mesh portal. It then obtains an IP address from a DHCP server on its Ethernet interface, discovers the master controller on that interface, registers the mesh radio with the controller, and obtains regulatory domain and mesh radio profiles for each mesh point interface. A mesh virtual AP is created on the mesh portal radio interface, the regulatory domain and radio profiles are used to bring up the radio on the correct channel, and the provisioned mesh cluster profile is used to setup the mesh virtual AP with the correct announcements on beacons and probe responses. On the non-mesh radio provisioned for access mode, that radio is a thin AP and everything on that interface works as a thin AP radio interface.

If the 802.11a/802.11g radio profile assigned to the mesh radio is enabled, the radio supports both mesh backhaul and client access Virtual APs. If the mesh radio is to be used exclusively for mesh backhaul traffic, associate that radio to a dedicated 802.11a/802.11g radio profile with the radio disabled so the mesh radios carry backhaul traffic only.

Booting the Mesh Point

When the mesh point boots, it scans for neighboring mesh nodes to establish a link to the mesh portal. All of the mesh nodes that establish the link are in the same mesh cluster. After the link is up, the mesh point uses the DHCP to obtain an IP address and uses the same master controller as their parent. The remaining boot sequence, if

applicable, is similar to that of a thin AP. Remember, the priority of the mesh point is establishing a link with neighboring mesh nodes, not establishing a control link to the controller.



NOTE: In a single hop environment, the mesh point establishes a direct link with the mesh portal.

Air Monitoring and Mesh

Each mesh node has an air monitor (AM) process that registers the BSSID and the MAC address of the mesh node to distinguish it from a thin AP. This allows the WLAN management system (WMS) on the controller and AMs deployed in your network to distinguish between APs, wireless clients, and mesh nodes. The WMS tables also identify the mesh nodes.

For all thin APs and mesh nodes, the AM identifies a mesh node from other packets monitored on the air, and the AM does not trigger “wireless-bridging” events for packets transmitted between mesh nodes.

Verifying the Network

To view a list of your Mesh APs via the WebUI, navigate to the one of the following windows:

- **Monitoring > Network > All Mesh Nodes**
- **Monitoring > Controller > Mesh Nodes**

To view mesh APs and the mesh topology tree using the command line interface, access the command-line interface in enable mode and issue the following commands:

- `show ap mesh active`
- `show ap mesh topology`

Verification Checklist

After provisioning the mesh APs, follow the steps below to ensure that the mesh network is up and operating correctly.

- Issue the command **show ap mesh topology** to verify all the mesh APs are up and the topology is as expected. (Wait 10 minutes after startup for the topology to stabilize.)
- Verify each mesh node has the expected RSSI to its neighboring mesh nodes. The mesh topology is updated periodically, so access the command-line interface and issue the command **show ap mesh neighbors** for the current status. If the RSSI is low, verify that the tx-power settings in the mesh node’s 802.11a/802.11g radio profiles are correct, or, if ARM is used, verify the correct minimum tx-power setting.
- Issue the command **show ap mesh debug provisioned-clusters** to verify that the mesh clusters are correctly defined and provisioned (with encryption if desired). Issue the **show running-config | include recovery** command to verify that the cluster’s recovery profile matches the controller’s.
- Verify antenna provisioning by issuing the **show ap provisioning** command and verify installation parameters for non-default installations (e.g. standard indoor APs deployed outside, or W-AP85 and W-AP175 Series outdoor APs deployed inside.). Ensure all APs use the same channel list by issuing the **show ap allowed-channels** command.
- *If the mesh-radio is to be reserved exclusively for mesh backhaul traffic*, issue the **show ap profile-usage** command to identify the radio’s 802.11a or 802.11g radio profile, then issue the command **show rf dot11a-radio-profile <profile>** or **show rf dot11g-radio-profile <profile>** to verify the radio is disabled in the profile. Next, use the **show ap bss-table** command to that verify no access Virtual APs are up on the mesh radio.

CLI Examples

Use the **show ap mesh active** command to verify all nodes are present and that EIRP is correct:

```
(host) # show ap mesh active
Mesh Cluster Name: ad-sw-mesh3400
-----
Name      Group   IP Address   BSSID           Band/Ch/EIRP/MaxEIRP  MTU   Enet Ports   Mesh
Role Parent #Children AP Type Uptime
-----
point-13 default 10.3.129.140 00:1a:1e:25:99:50 802.11a/149+/19/19    Tunnel/Tunnel
Point portal-9 0 125 1h:20m:52s
point-17 default 10.3.129.31 00:0b:86:38:7a:c0 802.11a/149/23/23    Tunnel      Point
portal-9 0 60 33m:31s
point-18 default 10.3.129.29 00:24:6c:80:db:b8 802.11a/149+/24/24    Tunnel      Point
portal-9 0 105 39m:56s
```

Use the **show ap mesh topology** command to verify the cluster topology, RSSI in presence of network traffic, and Tx and Rx rates.

```
(host) # show ap mesh topology (
Mesh Cluster Name: ad-sw-mesh3400
-----
Name      Mesh Role Parent Path Cost Node Cost Link Cost Hop Count RSSI Rate Tx/Rx Last
Update Uplink Age #Children
-----
point-13 Point (N) portal-9 3 0 0 1 66 300/300 1m:26s
9m:51s 0
```

Issue the command **show ap mesh neighbors ap-name <name>** to verify visibility of other mesh nodes is as expected:

```
(host) # show ap mesh neighbors ap-name point-18
Neighbor list:
-----
MAC      Portal      Channel Age Hops Cost Relation Flags RSSI Rate Tx/Rx
A-Req A-Resp A-Fail HT-Details Cluster \
ID
-----
portal-9 Yes 149+ 0 0 3.00 P 49m:28s HL 29 180/120 1
1 0 HT-40MHzzsgi-3ss ad-sw-me\
sh3400
point-17[p] d8:c7:c8:80:c:b0 149 0 1 25.00 N 55m:21s S 12 - 0
0 0 Unsupported ad-sw-me\
sh3400
point-13[p] d8:c7:c8:80:c:b0 149+ 0 1 3.00 N 49m:33s HL 47 - 3
3 0 HT-40MHzzsgi-2ss ad-sw-me\
sh3400
```

Configuring Remote Mesh Portals (RMPs)

You can deploy mesh portals to create a hybrid mesh/remote AP environment to extend network coverage to remote locations; this feature is called remote mesh portal, or RMP. The RMP feature integrates the functions of a remote AP (RAP) and the Mesh portal. As a RAP, it sets up a VPN tunnel back to the corporate switch that is used to secure control traffic between the RAP and the switch.

The Remote Mesh Portal feature allows you to configure a remote AP at a branch office to operate as a mesh portal for a mesh cluster. Other mesh points belonging to that cluster get their IP address and configuration settings from the main office via an IPsec tunnel between the remote mesh portal and the main office controller. This feature is useful for deploying an all-wireless branch office or creating a complete wireless network in locations where there is no wired infrastructure in place.

When the client at the branch office associates to a virtual AP in split-tunnel forwarding mode, the client's DHCP requests are forwarded over a GRE tunnel (split tunnel) to the corporate network. This communication is done over a secure VPN tunnel. The IPs are assigned from the corporate pool based on the VLAN tag information, which helps to determine the corresponding VLAN. The VLAN tag also determines the subnet from which the DHCP address has assigned.

A mesh point sends the DHCP request with the mesh private VLAN (MPV) parameter. The mesh point learns the MPV value from the response during the mesh association. When the split tunnel is setup for the RMP on the controller, the VLAN of the tunnel should be the MPV. A DHCP pool for the MPV should be setup on the switch. The use of MPV makes it easy for the RMP to decide which requests to forward over the split tunnel. All requests tagged with the MPV are sent over the split tunnel. Hence the MPV should be different from any user VLAN that is bridged using the mesh network.

The RMP configuration requires an AP license. For more information about Dell software licenses, see [Software Licenses on page 100.](#)

How RMP Works

When a client at the branch office associates to a split VAP, the client's DHCP requests are forwarded over a GRE tunnel (split tunnel) to the corporate network. This communication is done over a secure VPN tunnel. The IPs are assigned from the corporate pool based on the VLAN tag information, which helps to determine the corresponding VLAN. The VLAN tag also determines the subnet from which the DHCP address has assigned.

A mesh point sends the DHCP request with the mesh private VLAN (MPV) parameter. The mesh point learns the MPV value from the response during the mesh association. When the split tunnel is set up for the RMP on the controller, the VLAN of the tunnel should be the MPV. A DHCP pool for the MPV should be set up on the controller. The use of MPV makes it easy for the RMP to decide which requests to forward over the split tunnel. All requests tagged with the MPV are sent over the split tunnel. Hence the MPV should be different from any user VLAN that is bridged using the mesh network.

Figure 138: Working of RMP

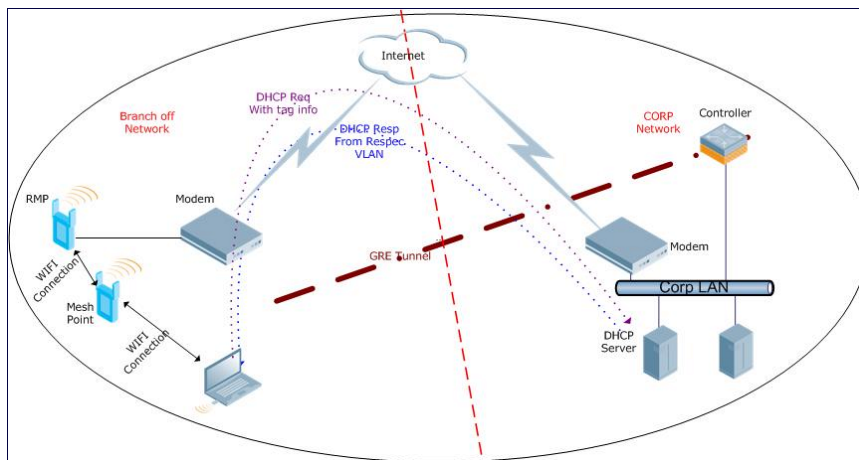

Creating a Remote Mesh Portal In the WebUI

A remote mesh portal must be provisioned as both a remote access point and a mesh portal. For instructions on provisioning the remote mesh portal as a remote access point, see ["Configuring the Secure Remote Access Point Service" on page 512.](#)

Wired ports on remote mesh portals can be configured in either bridge or split-tunnel forwarding mode. There are, however, limitations to the forwarding modes that can be used by other mesh node types. Do not use bridge or split-tunnel forwarding mode for wired ports on mesh points. Virtual APs on remote mesh portals and remote mesh points also do not support bridge or split-tunnel forwarding mode.



NOTE: A remote mesh portal does not support bridge mode Virtual APs or offline Virtual APs.

Provisioning the AP

1. Navigate to the **Configuration > Wireless > AP Installation > Provisioning** window.
2. Select the AP to provision as a remote mesh portal and click **Provision**. The **Provisioning** window appears.
3. In the **Authentication** section, select the **Remote AP** radio button.
4. In the **Remote AP Authentication Method** section of this window, select either **Pre-shared Key** or **Certificate**. If you selected **Pre-Shared Key**, enter and confirm the Internet Key Exchange Pre-Shared Key (IKE PSK).
5. In the **Master Discovery** section, set the Master IP address as the controller IP address.
6. In the **IP settings** section, select **Obtain IP Address Using DHCP**.
7. In the **AP List** section, click the **Mesh Role** drop-down list and select **Remote Mesh Portal**.

Figure 139: Provisioning an AP as a Remote Mesh Portal

The screenshot displays the 'Provisioning' configuration window for an AP. Key sections include:

- Authentication Method:** 'Remote AP' is selected.
- Remote AP Authentication Method:** 'Pre-shared Key' is selected. Fields for 'IKE PSK' and 'Confirm IKE PSK' are visible.
- User credential assignment:** 'Use Automatic Generation' is selected. Fields for 'User Name' (aruba123) and 'Password' are present.
- Master Discovery:** 'Use AP Discovery Protocol' is selected. 'Host Controller IP Address' is 10.4.46.234, and 'Master Controller IP Address/DNS name' is also 10.4.46.234.
- IP Settings:** 'Obtain IP Address Using DHCP' is selected.
- AP List:** A table lists APs. The selected AP has IP 1.1.1.1, Name 'ap65_1_22', and Group 'porell0'. The 'Mesh Role' dropdown is open, with 'Remote Mesh Portal' selected.

Defining the Mesh Private VLAN

Edit the mesh radio profile for the remote mesh portal and choose a new, non-zero tag value for the mesh private VLAN. Make sure that the mesh private VLAN so that it does not conflict with any local tags assigned in the mesh network. once configured, all Mesh Points come up in that Mesh Private Vlan. This mesh private VLAN must not be used as a VLAN for any other virtual AP.

1. Navigate to the **Configuration > Wireless > AP Configuration** window. Select either the **AP Group** or **AP Specific** tab.
 - If you selected the **AP Group** tab, click the **Edit** button by the remote mesh portal AP group with the profile you want to edit.
 - If you selected the **AP Specific** tab, click the **Edit** button by the remote mesh portal with the profile you want to edit.
2. In the Profiles list, expand the **Mesh** menu, then select **Mesh radio profile**.
3. In the **Profile Details** window pane, click the **Mesh radio profile** drop-down list and select the name of the profile you want to edit.
4. Set the **Mesh Private VLAN** parameter to define a VLAN ID (0-4094) for control traffic between an remote mesh point and mesh nodes.
5. Click **Apply** to save your changes.

Next, assign the remote mesh points with the same mesh cluster profile, 802.11a and 802.11g RF management profiles, and mesh radio profile as the remote mesh portal. If you have defined an AP group for all your remote mesh points, you can just assign the required profiles to the remote mesh point AP group. Otherwise, you must assign the required profiles to each individual remote AP.

Selecting a Mesh Radio Profile

Use the following procedure to select a mesh radio profile for a remote mesh AP or AP group:

1. Navigate to the **Configuration > Wireless > AP Configuration** window. Select either the **AP Group** or **AP Specific** tab.
 - If you selected **AP Group**, click the **Edit** button by the AP group to which you want to assign a new mesh radio profile.
 - If you selected **AP Specific**, click the **Edit** button by the AP to which you want to assign a new mesh radio profile.
2. Under the Profiles list, expand the **Mesh** menu, then select **Mesh radio profile**.
3. In the **Profile Details** window pane, click the **Mesh radio profile** drop-down list and select the desired mesh radio profile from the list.
4. Click **Apply**. The profile name appears in the Mesh Radio Profile list with your configured settings. If you configure this for the AP group, this profile also becomes the selected radio profile used by the mesh portal for your mesh network.

Selecting an RF Management Profile

Use the following procedure to select an RF management profile for a remote mesh AP or AP group:

1. Navigate to the **Configuration > Wireless > AP Configuration** window. Select either the **AP Group** or **AP Specific** tab.
 - If you selected **AP Group**, click the **Edit** button by the AP group name to which you want to assign a new 802.11a or 802.11g RF management profile.
 - If you selected **AP Specific**, click the **Edit** button by the AP to which you want to assign a new 802.11a or 802.11g RF management profile
2. Under the Profiles list, expand the **RF management** menu.
3. To select a **802.11a radio profile** for an AP or AP group, click **802.11a radio profile**. In the **Profile Details** window pane, click the **802.11a radio profile** drop-down list and select the desired profile from the list
-or-
To select a **802.11g radio profile** for an AP or AP group, click **802.11g radio profile**. In the **Profile Details** window pane, click the **802.11g radio profile** drop-down list and select the desired profile from the list
4. Click **Apply**. The profile name appears in the Profile list with your configured settings. If you configure this for the AP group, this profile also becomes the selected 802.11a or 802.11g RF management profile used by the mesh portal for your mesh network.



NOTE: For more information on configuring and managing 802.11a and 802.11g radio profiles, see "[802.11a and 802.11g RF Management Profiles](#)" on page 424.

Adding a Mesh Cluster Profile

Use the following procedure to add a mesh cluster profile to a remote mesh AP or AP group:

1. Navigate to the **Configuration > Wireless > AP Configuration** window. Select either the **AP Group** or **AP Specific** tab.

- If you selected **AP Group**, click the **Edit** button by the AP group name to which you want to assign a new mesh cluster profile.
 - If you selected **AP Specific**, click the **Edit** button by the AP to which you want to assign a new mesh cluster profile
2. Under the Profiles list, expand the Meshmenu, then select **Mesh Cluster profile**.
 3. In the **Profile Details** window pane, click the **Mesh Cluster profile** drop-down list select **New**.
 - To add an existing mesh-cluster profile to the selected AP group, click the **Add a profile** drop-down list and select a new profile name from the list.
 4. Click the **using priority** drop-down list to select a priority for the mesh cluster profile. The lower the number, the higher the priority.

NOTE: If you configure multiple cluster profiles with different cluster priorities, you manually override the link metric algorithm because the priority takes precedence over the path cost. In this scenario, the mesh portal uses the profile with the highest priority to bring-up the mesh network.

5. Click **Add** to add the mesh cluster profile to the AP group.

Configuring a DHCP Pool

In this next step, you must configure a DHCP pool where the DHCP server is on the subnet associated with mesh private VLAN. Mesh points get their IP address from this subnet pool. To complete this task, refer to the procedure described in “Configuring the DHCP Server on the Remote AP”.

Configuring the VLAN ID of the Virtual AP Profile

The VLAN of this Virtual AP must have the same VLAN ID as the mesh private VLAN.

1. Navigate to **Configuration > Wireless > AP Configuration** window. Select either the **AP Group** or **AP Specific** tab. Click the **Edit** button by the applicable AP group name or AP name with the virtual AP profile you want to configure.
2. Under Profiles, select **Wireless LAN**, then **Virtual AP**.
3. To create a new virtual AP profile in the WebUI, select **New** from the **Add a profile** drop-down menu. Enter the name for the virtual AP profile, and click **Add**.

NOTE: Whenever you create a new virtual AP profile in the WebUI, the profile automatically contains the “default” SSID profile with the default “Dell-ap” ESSID. You must configure a new ESSID and SSID profile for the virtual AP profile before you apply the profile.

- a. In the **Profile Details** window, click the **AAA Profile** drop-down list and select the previously configured AAA profile. The **AAA Profile** pop-up window appears.
 - b. To set the AAA profile and close the window, click **Apply**.
 - c. In the **Profile Details** entry for the new virtual AP profile, select **NEW** from the **SSID Profile** drop-down menu. A pop-up window displays to allow you to configure the SSID profile.
 - d. Enter the name for the SSID profile.
 - e. Under **Network**, enter a name in the Network Name (SSID) field.
 - f. Under **Security**, select the network authentication and encryption methods.
 - g. To set the SSID profile and close the window, click **Apply**.
4. Click **Apply** at the bottom of the **Profile Details** window.
 5. Click the new virtual AP name in the **Profiles list** or **Profile Details** window pane to display the configuration parameters for this profile.
 6. In the **Profile Details** window:

- a. Make sure **Virtual AP enable** is selected.
- b. From the **VLAN** drop-down menu, select the VLAN ID for the mesh private VLAN.
- c. From the **Forward mode** drop-down menu, select **split-tunnel**.
- d. Click **Apply**.

Provisioning a Remote Mesh Portal In the CLI

Reprovisioning the AP causes it to automatically reboot. When you use the CLI to reprovision a mesh node, you may also provision other AP settings.

```
(host) (config) #provision-ap
    read-bootinfo ap-name <name>
    mesh-role remote-mesh-portal
    reprovision ap-name <name>
```

Additional Information

By default, the data frames the mesh portal receives on its mesh link are forwarded according to the bridge table entries on the portal. However, frames received on mesh private VLAN (MPV) are treated differently by the remote mesh portal. These frames are treated the same as frames received on a split SSID and are routed rather than bridged. Mesh points obtain DHCP addresses from the corporate network, then register with the controller using these IP addresses. When these mesh points send and receive PAPI control traffic from the main office controller, it controls these mesh points just as if they were on a local VLAN. PAPI traffic containing keys and other secret information receives IPsec encryption and decryption when it is forwarded to the controller through the VPN tunnel.

Not all traffic from a mesh point is sent on the mesh private VLAN. When a mesh point bridges data received via its Ethernet interface or from clients connected to an access radio VAP, the mesh point does not tag the frame with the mesh private VLAN tag when it sends the data through mesh link to the remote mesh portal. Note that the mesh point may still tag the frame depending on the VLAN of the virtual AP and the native VLAN specified in the system profile. Care must be taken to assign the MPV value so that it does not clash with any local tags assigned in the mesh network. In this case, the portal performs the default operation that is to bridge the frame based on its bridge table.

Traffic destined to the Internet is recognized as such by the remote mesh portal based on ACL rules. This traffic is NATed on the remote mesh portal's Ethernet interface.

Chapter 25

VRRP

The underlying mechanism for the Dell redundancy solution is the Virtual Router Redundancy Protocol (VRRP). VRRP is used to create various redundancy solutions, including:

- pairs of local Dell controllers acting in an active-active mode or a hot-standby mode.
- a master controller backing up a set of local Dell controllers.
- a pair of Dell controllers acting as a redundant pair of master Dell controllers in a hot-standby mode.

VRRP eliminates a single point of failure by providing an election mechanism, among the Dell controllers, to elect a VRRP “master” controller. If VRRP preemption is disabled (the default setting) and all Dell controllers share the same priority, the first controller that comes up becomes the master. However, if VRRP preemption is enabled and all Dell controllers share the same priority, the controller with the highest IP address becomes the master.

The master controller owns the configured virtual IP address for the VRRP instance. When the master controller becomes unavailable, a backup controller steps in as the master and takes ownership of the virtual IP address. All network elements (APs and other Dell controllers) can be configured to access the virtual IP address, thereby providing a transparent redundant solution to your network.

Configuring Redundancy Parameters

Depending on your redundancy solution, you configure the VRRP parameters listed in [Table 140](#) on your master and local Dell controllers.

Table 140: VRRP Parameters

Parameter	Description
Virtual Router ID	This uniquely identifies this VRRP instance. For ease in administration, you should configure this with the same value as the VLAN ID.
Advertisement Interval	This is the interval, in seconds, between successive VRRP advertisements sent by the current <i>master</i> . The default interval time is recommended. Default: 1 second
Authentication Password	This is an optional password, of up to eight characters, that can be used to authenticate VRRP peers in their advertisements. If this is not configured, there is no authentication password set.
Description	This is an optional text description to describe the VRRP instance.
IP Address	This is the virtual IP address that will be owned by the elected VRRP master.
Enable Router Pre-emption	Selecting this option means that a controller can take over the role of <i>master</i> if it detects a lower priority controller currently acting as <i>master</i> .
Delay	Specifying a value enables the delay timer. The timer is triggered when the VRRP state moves out of backup or init state to become a master. This is applicable only if router pre-

Parameter	Description
	emption is enabled. When the timer is triggered, it forces VRRP to wait for a specified period of time, so that all the applications are ready before coming up. This prevents the APs from connecting to the controller before it can receive them. In the mean time, if there is an advertisement from another VRRP, the VRRP stops the timer and does not transition to master.
Priority	Priority level of the VRRP instance for the controller. This value is used in the election mechanism for the <i>master</i> .
Tracking	Configures a tracking mechanism that modifies a specified <i>value</i> to the priority after a controller has been the master for the VRRP instance. This mechanism is used to avoid failing over to a backup Master for transient failures. Tracking can be based on one of the following: <ul style="list-style-type: none"> Master Up Time: how long the controller has been the master. The value of <i>duration</i> is the length of time that the administrator expects will be long enough that the database gathered in the time is too important to be lost. This will obviously vary from instance to instance. VRRP Master State Priority: the master state of another VRRP. Tracking can also be based on the interface states of the controller: <ul style="list-style-type: none"> VLAN and Interface: prevents asymmetric routing by tracking multiple VRRP instances. The priority of the VRRP interface determined by the <i>sub</i> value can increase or decrease based on the operational and transitional states of the specified VLAN or Fast Ethernet/Gigabit Ethernet port. When the VLAN or interface comes up again, the value is restored to the previous priority level. You can track a combined maximum of 16 interfaces and VLANs. For example, you can track an interface that connects to a default gateway. In this situation, configure the VRRP priority to decrease and trigger a VRRP master re-election if the interface goes down. This not only prevents network traffic from being forwarded, but reduces VRRP processing.
Admin State	Administrative state of the VRRP instance. To start the VRRP instance, change the admin state to UP in the WebUI.
VLAN	VLAN on which the VRRP protocol will run.

Configuring the Local Controller for Redundancy

In a Dell network, the APs are controlled by a controller. The APs tunnel all data to the controller which processes the data, including encryption/decryption, bridging/forwarding, etc.

Local controller redundancy refers to providing redundancy for a controller such that the APs “fail over” to a *backup* controller if a controller becomes unavailable. Local controller redundancy is provided by running VRRP between a pair of Dell controllers.



NOTE: The two Dell controllers need to be connected on the same broadcast domain (or Layer-2 connected) for VRRP operation. The two Dell controllers should be of the same class (for example, and both Dell controllers should be running the same version of ArubaOS.

The APs are then configured to connect to the “virtual-IP” configured for the VRRP instance.

Collect the following information needed to configure local controller redundancy:

- **VLAN ID** on the two local Dell controllers that are on the same Layer-2 network and is used to configure VRRP.
- **Virtual IP address** to be used for the VRRP instance.

You can use either the WebUI or CLI to configure VRRP on the local Dell controllers. For this topology, it is recommended to use the default priority value.

In the WebUI

1. Navigate to the **Configuration > Advanced Services > Redundancy** page on the WebUI for each of the local Dell controllers.
2. Under Virtual Router Table, click **Add** to create a VRRP instance.
3. Enter the IP Address for the virtual router. Select the VLAN on which VRRP will run. Set the Admin State to Up.
4. Click **Done** to apply the configuration and add the VRRP instance.

In the CLI

```
(host) (config) #vrrp <id>
  ip address <ipaddr>
  vlan <vlan>
  no shutdown
```

Configuring the LMS IP

Configure the APs to terminate their tunnels on the virtual-IP address. To specify the controller to which an AP or AP group tunnels client traffic, you configure the LMS IP in the AP system profile on the master controller. For information on how to configure the LMS IP in the AP system profile, see [“Configuring APs” on page 685](#).



NOTE: This configuration needs to be executed on the master controller; the APs obtain their configuration from the master controller.

In the WebUI

1. Navigate to the **Configuration > Wireless > AP Configuration** page on the master controller.
 - If you select AP Group, click Edit for the AP group name for which you want to configure the LMS IP.
 - If you select AP Specific, select the name of the AP for which you want to configure the LMS IP.
2. Under the Profiles section, select AP to display the AP profiles.
3. Select the AP system profile you want to modify.
4. Enter the controller IP address in the LMS IP field.
5. Click **Apply**.

In the CLI

On the master controller:

```
(host) (config) #ap system-profile <profile>
  lms-ip <ipaddr>

(host) (config) #ap-group <group>
  ap-system-profile <profile>

(host) (config) #ap-name <name>
  ap-system-profile <profile>
```

Configuring the Master Controller for Redundancy

The master controller in the Dell user-centric network acts as a single point of configuration for global policies such as firewall policies, authentication parameters, RF configuration to ease the configuration and maintenance of a wireless network. It also maintains a database related to the wireless network that is used to make any adjustments

(automated as well as manual) in reaction to events that cause a change in the environment (such as an AP becoming unavailable).

The master controller is also responsible for providing the configuration for any AP to complete its boot process. If the master controller becomes unavailable, the network continues to run without any interruption. However, any change in the network topology or configuration will require the availability of the master controller.

To maintain a highly redundant network, the administrator can use a controller to act as a hot standby for the master controller. The underlying protocol used is the same as in local redundancy, that is, VRRP.

- Collect the following data before configuring master controller redundancy.
 - **VLAN ID** on the two Dell controllers that are on the same layer 2 network and will be used to configure VRRP.
 - **Virtual IP address** that has been reserved to be used for the VRRP instance
- You can use either the WebUI or CLI to configure VRRP on the master Dell controllers (see [Table 140](#)). For this topology, the following are recommended values:
 - For priority: Set the master to 110; set the backup to 100 (the default value)
 - Enable preemption
 - Configure master up time or master state tracking with an add value of 20.

The following is a configuration example for the “*initially-preferred master*”.

```
(host) (config) #vrrp 22
vlan 22
ip address 10.200.22.254
priority 110
preempt
authentication password
description Preferred-Master
tracking master-up-time 30 add 20
no shutdown
```

The following configuration is the corresponding VRRP configuration for the peer controller.

```
(host) (config) #vrrp 22
vlan 22
ip address 10.200.22.254
priority 100
preempt
authentication password
description Backup-Master
tracking master-up-time 30 add 20
no shutdown
```

Use the following commands to associate the VRRP instance with master controller redundancy.

Table 141: VRRP Commands

Command	Explanation
master-redundancy	Enter the master-redundancy context.
master-vrrp <id>	Associates a VRRP instance with master redundancy. Enter the virtual router ID of the VRRP instance.
peer-ip-address <ipaddr> ipsec <key>	Loopback IP address of the peer controller for master redundancy. The pre-shared key secures communication between the master Dell controllers. Specify a key of up to 64 characters.

Command	Explanation
<code>masterip <ipaddr> ipsec <key></code>	Configures the master IP address and pre-shared key on a local controller for communication with the master controller. Configure this to be the virtual IP address of the VRRP instance used for master redundancy.

 NOTE: All the APs and local Dell controllers in the network should be configured with the virtual IP address as the master IP address. The master IP address can be configured for local Dell controllers during the Initial Setup. The controller will require a reboot after changing the master IP on the controller.

If DNS resolution is the chosen mechanism for the APs to discover their master controller, ensure that the name “*aruba-master*” resolves to the same virtual IP address configured as a part of the master redundancy.

Configuring Database Synchronization

In a redundant master controller scenario, you can configure a redundant pair to synchronize their WMS and local user databases. In addition, you can also synchronize RF Plan data between the pair of Dell controllers. You can either manually or automatically synchronize the databases.

 NOTE: When synchronizing the databases, Dell recommends that you also synchronize RF plan data.

When manually synchronizing the database, the active VRRP master synchronizes its database with the standby. The command takes effect immediately.

When configuring automatic synchronization, you set how often the two Dell controllers synchronize their databases. To ensure successful synchronization of database events, you should set periodic synchronization to a minimum period of 20 minutes.

In the WebUI

1. On each controller, navigate to the **Configuration > Advanced Services > Redundancy** page.
2. Under Database Synchronization Parameters, do the following:
 - a. Select the **Enable periodic database synchronization** check box. This enables database synchronization.
 - b. Enter the frequency of synchronizing the databases. Dell recommends a minimum value of 20 minutes.
 - c. By default, RF Plan data is also synchronized. Dell recommends that you always enable this option.
3. Click **Apply**.

In the CLI

Use the following commands to configure database synchronization.

Table 142: Database synchronization commands

Command	Description
<code>database synchronize</code>	This enable mode command manually synchronizes the databases and takes effect immediately.
<code>database synchronize rf-plan-data</code>	This config mode command includes RF plan data when

Command	Description
	synchronizing databases. This data is included by default.
database synchronize period <minutes>	This config mode command defines the scheduled interval for synchronizing the databases.

To view the database synchronization settings on the controller, use the following command:

```
(host) #show database synchronize
```

Enabling Incremental Configuration Synchronization (CLI Only)

Typically when the master and the local is synchronized, the complete configuration is sent to the local. You can, now send only the incremental updates to the local by using the following CLI commands

Use the following commands for incremental configuration synchronization:

Table 143: Incremental Configuration Synchronization Commands

Command	Description
cfgm set sync-type <complete>	The master sends full configuration file to the local.
cfgm set sync-type <snapshot>	The master sends only the incremental configuration to the local. NOTE: By default, this configuration is enabled.
cfgm set sync-command-block <number>	To configure the number of command-list blocks. Each block contains a list of global configuration commands for each write-mem operation. By default, the number is 3.
show master-configpending	To show a list of global commands, which are not saved but are sent to the local.
clear master-local-session <A.B.C.D>	To manually push the full configuration to the local.

Configuring Master-Local Controller Redundancy

This section outlines the concepts behind a redundancy solution where a master can act as a backup for one or more local Dell controllers and shows how to configure the Dell controllers for such a redundant solution. In this solution, the local Dell controllers act as the controller for the APs. When any one of the local Dell controllers becomes unavailable, the master takes over the APs controlled by that local controller for the time that the local controller remains unavailable. It is configured such that when the local controller comes back again, it can take control over the APs once more.

This type of redundant solution is illustrated by the following topology diagram.



NOTE: This solution requires that the master controller have Layer-2 connectivity to all the local Dell controllers.

Figure 144: Redundant Topology: Master-Local Redundancy

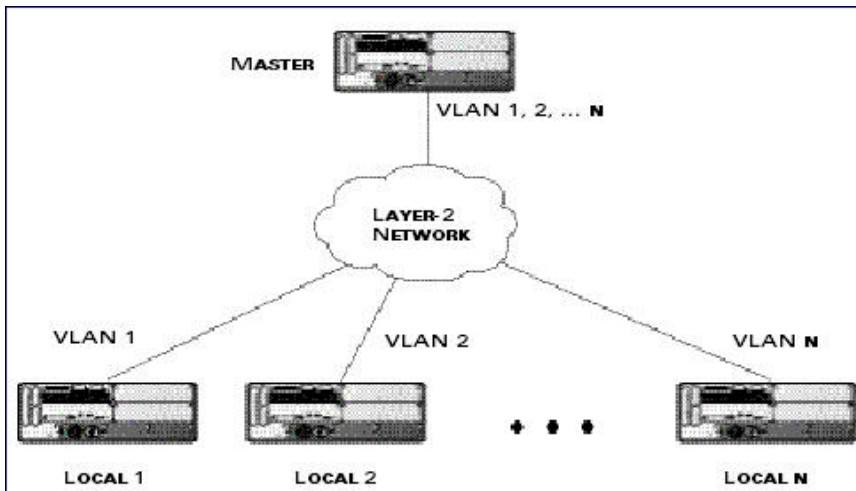

The network in [Figure 144](#), the master controller is connected to the local Dell controllers on VLANs 1 through n through a Layer-2 network. To configure redundancy as described in the conceptual overview for master-local redundancy, configure VRRP instances on each of the VLANs between the master and the respective local controller. The VRRP instance on the local controller is configured with a higher priority to ensure that when available, the APs always choose the local controller to terminate their tunnels.

- Configure the interface on the master controller to be a trunk port with 1, 2... n being member VLANs.
- Collect the following data before configuring master controller redundancy.
 - **VLAN IDs** on the Dell controllers corresponding to the VLANs 1, 2... n shown in the topology above.
 - **Virtual IP addresses** that has been reserved to be used for the VRRP instances.
- You can use either the WebUI or CLI to configure VRRP on the master Dell controllers (see [Table 140](#)). For this topology, the following are recommended values:
 - For priority: Set the local to 110; set the master to 100 (the default value)
 - Enable preemption



NOTE: The master controller is configured for a number of VRRP instances (equal to the number of local Dell controllers the master is backing up).

The following example configuration of the master controller in such a topology for one of the VLANs (in this case VLAN 22).

```
(host) (config) #vrrp 22
  vlan 22
  ip address 10.200.22.254
  priority 100
  preempt
  authentication password
  description Master-acting-as-backup-to-local
  tracking master-up-time 30 add 20
  no shutdown
```

The following example configuration on the corresponding local controller.

```
(host) (config) #vrrp 22
  vlan 22
  ip address 10.200.22.254
  priority 110
  preempt
```

```
authentication password
description local-backed-by-master
no shutdown
```

To configure APs, configure the appropriate virtual IP address (depending on which controller is expected to control the APs) for the LMS IP address parameter in the AP system profile for an AP group or specified AP.

As an example, the administrator can configure APs in the AP group “floor1” to be controlled by local controller 1, APs in the AP group “floor2” to be controlled by local controller 2 and so on. All the local Dell controllers are backed up by the master controller. In the AP system profile for the AP group “floor1”, enter the virtual IP address (10.200.22.154 in the example configuration) for the LMS IP address on the master controller.



NOTE: You configure APs on the master controller.

Configuration changes take effect only after you reboot the affected APs; this allows them to reassociate with the local controller. After rebooting, these APs appear to the new local controller as local APs.

Dell's implementation of Rapid Spanning Tree Protocol (RSTP) is as specified in 802.1w with backward compatibility to legacy Spanning Tree (STP) 802.1D. RSTP takes advantage of point-to-point links and provides rapid convergence of the spanning tree. RSTP is enabled by default on all Dell controllers.

Topics in this chapter include:

- ["Understanding RSTP Migration and Interoperability" on page 485](#)
- ["Working with Rapid Convergence" on page 485](#)
- ["Configuring RSTP" on page 487](#)
- ["Troubleshooting RSTP" on page 488](#)

Understanding RSTP Migration and Interoperability

ArubaOS supports RSTP on the following interfaces:

- FastEthernet IEEE 802.3—fastethernet
- GigabitEthernet IEEE 802.3—gigabitethernet
- Port Channel ID—port-channel

Working with Rapid Convergence

Since RSTP is backward compatible with STP, it is possible to configure bridges RSTP (and STP) in the same network. However, such mixed networks may not always provide rapid convergence. RSTP provides rapid convergence when interfaces are configured as either:

- Edge ports—These are the interfaces/ports connected to hosts. These interfaces are immediately moved to the forwarding state. In this mode an interface forwards frames by default until it receives a BPDU (Bridge Protocol Data Units) indicating that it should behave otherwise; it does not go through the Listening and Learning states.
- Point-to-Point links—These are the interfaces/ports connected directly to neighboring bridges over a point-to-point link. RSTP negotiates with the neighbor bridge for rapid convergence/transition only when the link is point-to-point.

[Table 145](#) compares the port states between STP and RSTP.

Table 145: *Port State Comparison*

STP (802.1d) Port State	RSTP (802.1w) Port State
Disabled	Discarding
Blocking	Discarding

STP (802.1d) Port State	RSTP (802.1w) Port State
Listening	Discarding
Learning	Learning
Forwarding	Forwarding

In addition to port state changes, RSTP introduces port roles for all the interfaces (see [Table 146](#)).

Table 146: Port Role Descriptions

RSTP (802.1w) Port Role	Description
Root	The port that receives the best BPDU on a bridge.
Designated	The port can send the best BPDU on the segment to which it is connected.
Alternate	The port offers an alternate path, in the direction of root bridge, to that provided by bridge's root port.
Backup	The port acts as a backup for the path provided by a designated port in the direction of the spanning tree.

The `show spantree` command (configuration mode) output reveals the state and port role.

```
(host) (config) #show spantree

Designated Root MAC      00:0b:86:50:3c:20
Designated Root Priority  32768
Root Max Age 20 sec    Hello Time 2 sec    Forward Delay 15 sec

Bridge MAC                00:0b:86:50:3c:20
Bridge Priority            32768
Configured Max Age 20 sec  Hello Time 2 sec    Forward Delay 15 sec

Rapid Spanning-Tree port configuration
-----
Port      State      Cost  Prio  PortFast  P-to-P  Role
----      -
FE 1/0    Discarding  0     128   Disable   Enable   Disabled
FE 1/1    Forwarding  0     128   Disable   Enable   Designated
FE 1/2    Forwarding  0     128   Disable   Enable   Root
FE 1/3    Discarding  0     128   Disable   Disable  Disabled
FE 1/4    Discarding  0     128   Disable   Enable   Alternate
```

Also, the `show spanning-tree interface` command indicates the state and roles; see the partial output below.

```
(host) #show spanning-tree interface fastethernet 1/1

Interface FE 1/7 (port 8) in Spanning tree is FORWARDING
Port path cost 19, Port priority 128 Role DESIGNATED
```

Edge Port and Point-to-Point

At the interface level, the `portfast` command specifies an interface as an edge port and the `point-to-point` command specifies an interface as a point-to-point link. Since RSTP is enabled by default, all the interfaces are, by default, point-to-point links.

Configuring RSTP

Use either the command line reference or the WebUI to configure RSTP.

In the WebUI

The RSTP port interface is designated as point-to-point, by default, in the existing port configuration screen (Figure 147).

Figure 147: *Configuring RSTP*

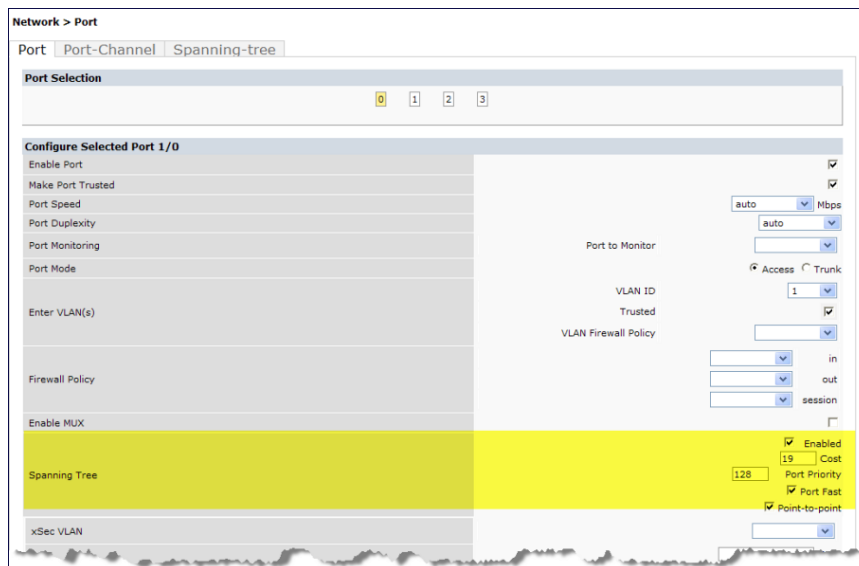

Since RSTP is enabled by default, the default values appear in the WebUI. Table 148 lists the RSTP defaults and ranges (when applicable) in the configuration interface mode (`config-if`).

Table 148: *RSTP Default Values*

Feature	Default Value/Range
Port Cost	The RSTP interface path cost. Range: 1 - 65536 Default: Based on Interface type: Fast Ethernet 10Mbps—100 Fast Ethernet 100Mbps—19 1 Gigabit Ethernet—4 10 Gigabit Ethernet—2
Priority	Change the interface's RSTP priority Range: 0 - 255 Default: 128

Feature	Default Value/Range
Port Fast	Change from blocking to forwarding Default: disabled
Point-to-Point	Enabled—Set the interface as a point-to-point link

In the CLI

Change the default configurations via the command line.

```
(host) (config-if)#spanning-tree ?
cost                Change an interface's spanning tree path cost
point-to-point      Set interface as point-to-point link
port-priority        Change an interface's spanning tree priority
portfast            Allow a change from blocking to forwarding
```

Monitoring RSTP

Statistical information for point-to-point, role, BPDU etc. can be viewed from the WebUI (see [Figure 149](#)).

Figure 149: Monitoring RSTP

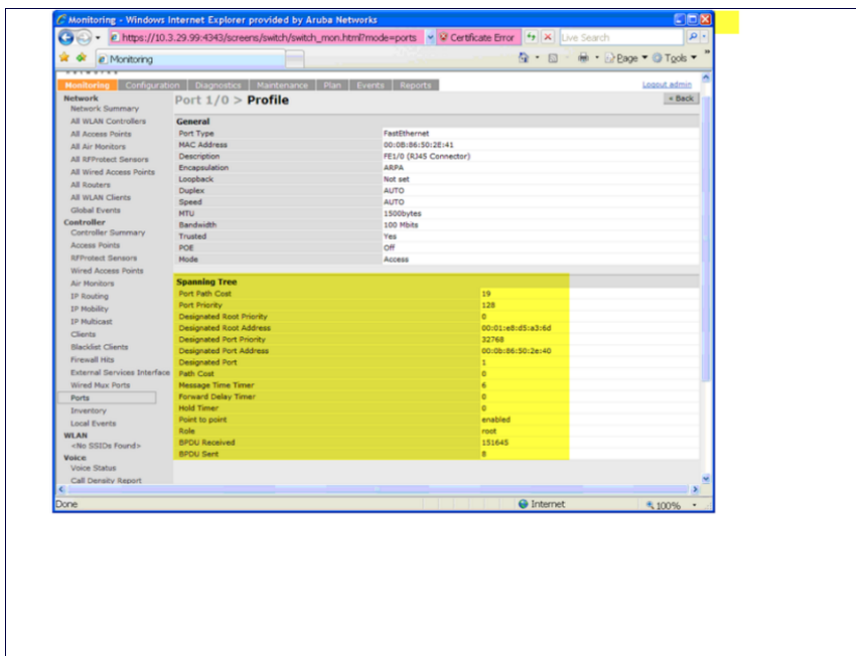

Troubleshooting RSTP

The following points give some troubleshooting tips.

- The `show spantree` command displays the root and the bridge information; verify that they are correct. Also displayed is the port/interface information (for example state, role, etc.); make sure that the state and role information correspond to each other.

```
(host) (config) #show spantree
Designated Root MAC      00:0b:86:50:3c:20
Designated Root Priority  32768
Root Max Age 20 sec     Hello Time 2 sec     Forward Delay 15 sec
```



```
Bridge MAC          00:0b:86:50:3c:20
Bridge Priority     32768
Configured Max Age 20 sec  Hello Time 2 sec  Forward Delay 15 sec
```

Rapid Spanning-Tree port configuration

```
-----
Port      State      Cost  Prio  PortFast  P-to-P  Role
-----
FE 1/0    Discarding  0     128   Disable   Enable   Disabled
FE 1/1    Forwarding  0     128   Disable   Enable   Designated
FE 1/2    Forwarding  0     128   Disable   Enable   Root
FE 1/3    Discarding  0     128   Disable   Disable  Disabled
FE 1/4    Discarding  0     128   Disable   Enable   Alternate
```

- The show spanning-tree interface command (config-if mode) displays Tx/Rx BPDU counters. Validate those values. For example, if a port's role is "designated", it only transmit BPDUs and does not receive any. In this case, Tx counter will keep incrementing while Rx counter will remain the same. It is quite opposite for a port with role as "root/alternate/backup".

```
(host) (config-if)#show spanning-tree interface fastethernet 1/1
```

```
Interface FE 1/1 (port 2) in Spanning tree is FORWARDING
Port path cost 19, Port priority 128 Role DISNIGNATED
PortFast DISABLED P-to-P ENABLED
Designated root has priority 0 address 00:01:e8:d5:a3:6d
Designated bridge has priority 32768 address 00:0b:86:50:58:30
Designated port is 2, path cost 0
Timers: message age 0, forward delay 20, hold 0
Counts: BPDUs received 0, sent 0
```

```
(host) (config-if)#
```

PVST+ (Per-VLAN Spanning Tree Plus) provides for load balancing of VLANs across multiple ports resulting in optimal usage of network resources. PVST+ also ensures interoperability with industry accepted PVST+ protocols.



NOTE: PVST+ is disabled by default.

Topics in this chapter include:

- "Understanding PVST+ Interoperability and Best Practices" on page 490
- "Enabling PVST+ in the CLI" on page 490
- "Enabling PVST+ in the WebUI" on page 491

Understanding PVST+ Interoperability and Best Practices

The interoperability between RSTP and PVST+ are:

- When the access port on the controller and the trunk port terminate on one Layer 2 switch running PVST+, PVST+ will send untagged STP BPDUs on the access port; it also transmits untagged STP BPDUs (in addition to the other PVST+ BPDUs) on the native VLAN trunk port. If the Dell controller is the root, it will detect a loop on the native VLAN.



NOTE: If PVST+ is not on the controller, best practices recommends disabling RSTP on the Dell controller to avoid a looping issue.

- For VLAN load balancing when Dell controllers are connected to armed mode, the VLAN priorities on two ports and bridge priorities must be configured so that one set of VLANs are active on one link and the other set of VLANs are active on the other link.
- Supported instances are 64 on the W-7200 Series, W-6000M3, and W-3000 Series; 32 on the W-600 Series.

Enabling PVST+ in the CLI

PVST+ is disabled by default. Enable PVST+, ensure a VLAN instance is configured, and then configure PVST+.

1. Enable PVST+:

```
spanning-tree mode rapid-pvst
```
2. Configure PVST+ forward time; the following command sets the time VLAN 2 spends in the listening and learning state (3 seconds).

```
spanning-tree vlan 2 forward-time 3
```
3. Configure PVST+ hello time; the following command sets the time VLAN 2 waits to transmit BPDUs to four seconds:

```
spanning-tree vlan 2 hello-time 4
```

4. Configure PVST+ max age; the following command sets the time VLAN 2 waits to receive a hello packet to 30 seconds:

```
spanning-tree vlan 2 max-age 30
```

5. Configure PVST+ priority: the following command sets the VLAN 2 priority to 10, making it more likely to become the root bridge:

```
spanning-tree vlan 2 priority 10
```

6. Configure PVST+ on a range of VLANs using the VLAN IDs (coma separated or hyphen separated)

```
spanning-tree vlan range 2-6,11
```

Enabling PVST+ in the WebUI

From the WebUI, add a VLAN instance and enable PVST+

The screenshot shows the 'Add New VLAN Instance' configuration page in the WebUI. The page title is 'Network > Spanning Tree > Add New VLAN Instance'. There is a 'Back' button in the top right corner. The configuration fields are as follows:

VLAN	15
Forward time	4
Hello time	10
Max age	14
Priority	32768

There is an 'Apply' button in the bottom right corner of the configuration area. Below the configuration fields is a 'Commands' section with a 'Hide Commands' link. The commands listed are:

```
spanning-tree mode rapid-pvst
spanning-tree vlan 15
spanning-tree vlan 15 forward-time 4
spanning-tree vlan 15 hello-time 10
spanning-tree vlan 15 max-age 14
spanning-tree vlan 15 priority 32768
```

Chapter 28

IP Mobility

A *mobility domain* is a group of Dell controllers among which a wireless user can roam without losing their IP address. Mobility domains are not tied with the master controller, thus it is possible for a user to roam between Dell controllers managed by different master Dell controllers as long as all of the Dell controllers belong to the same mobility domain.

You enable and configure mobility domains only on Dell controllers. No additional software or configuration is required on wireless clients to allow roaming within the domain.

Topics in this chapter include:

- "Understanding Dell Mobility Architecture" on page 492
- "Configuring Mobility Domains" on page 493
- "Tracking Mobile Users" on page 497
- "Configuring Advanced Mobility Functions" on page 499
- "Understanding Bridge Mode Mobility Deployments" on page 503
- "Enabling Mobility Multicast" on page 504

Understanding Dell Mobility Architecture

Dell's layer-3 mobility solution is based on the Mobile IP protocol standard, as described in RFC 3344, "IP Mobility Support for IPv4". This standard addresses users who need both network connectivity and mobility within the work environment.

Unlike other layer-3 mobility solutions, a Dell mobility solution does not require that you install mobility software or perform additional configuration on wireless clients. The Dell controllers perform all functions that enable clients to roam within the mobility domain.

In a mobility domain, a *mobile client* is a wireless client that can change its point of attachment from one network to another within the domain. A mobile client receives an IP address (*a home address*) on a *home network*.

A mobile client can detach at any time from its home network and reconnect to a *foreign network* (any network other than the mobile client's home network) within the mobility domain. When a mobile client is connected to a foreign network, it is bound to a *care-of address* that reflects its current point of attachment. A care-of address is the IP address of the Dell controller in the foreign network with which the mobile client is associated.

The *home agent* for the client is the controller where the client appears for the first time when it joins the mobility domain. The home agent is the single point of contact for the client when the client roams. The *foreign agent* for the client is the controller which handles all Mobile IP communication with the home agent on behalf of the client. Traffic sent to a client's home address is intercepted by the home agent and tunneled for delivery to the client on the foreign network. On the foreign network, the foreign agent delivers the tunneled data to the mobile client.

Figure 150 shows the routing of traffic from Host A to Mobile Client B when the client is away from its home network. The client's care-of address is the IP address of the Dell controller in the foreign network.

The numbers in the Figure 150 correspond to the following descriptions:

1. Traffic to Mobile Client B arrives at the client's home network via standard IP routing mechanisms.

2. The traffic is intercepted by the home agent in the client's home network and tunneled to the care-of address in the foreign network.
3. The foreign agent delivers traffic to the mobile client.
4. Traffic sent by Mobile Client B is also tunneled back to the home agent.

Figure 150: Routing of Traffic to Mobile Client within Mobility Domain

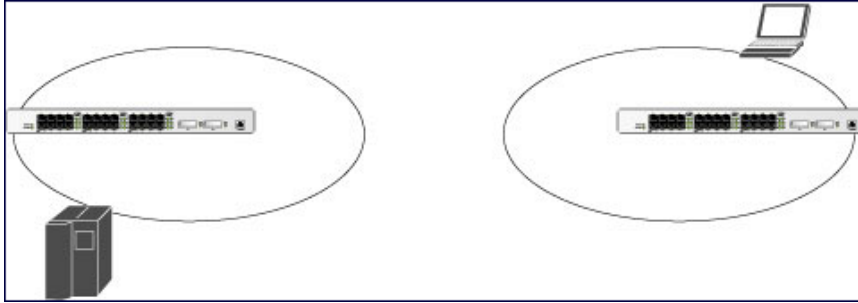

Configuring Mobility Domains

Before configuring a mobility domain, you should determine the user VLAN(s) for which mobility is required. For example, you may want to allow employees to be able to roam from one subnetwork to another. All Dell controllers that support the VLANs into which employee users can be placed should be part of the same mobility domain.



NOTE: Dell mobility domains are supported only on Dell controllers.

A controller can be part of multiple mobility domains, although Dell recommends that a controller belong to only one domain. The Dell controllers in a mobility domain do not need to be managed by the same master controller.

You configure a mobility domain on a master controller; the mobility domain information is pushed to all local Dell controllers that are managed by the same master controller. On each controller, you must specify the *active* domain (the domain to which the controller belongs). If you do not specify the active domain, the controller will be assigned to a predefined “default” domain.

Although you configure a mobility domain on a master controller, the master controller does not need to be a member of the mobility domain. For example, you could set up a mobility domain that contains only local Dell controllers; you still need to configure the mobility domain on the master controller that manages the local Dell controllers. You can also configure a mobility domain that contains multiple master Dell controllers; you need to configure the mobility domain on each master controller.

The basic tasks you need to perform to configure a mobility domain are listed below. The sections following describe each task in further detail. A sample mobility domain configuration is provided in ["Example Configuration" on page 495](#).

Table 151: Tasks to Configure a Mobility Domain

On a master controller:	On all Dell controllers in the mobility domain:
<ul style="list-style-type: none"> ● Configure the mobility domain, including the entries in the home agent table (HAT) 	<ul style="list-style-type: none"> ● Enable mobility (disabled by default) ● Join a specified mobility domain (not required for “default” mobility domain)

You can enable or disable IP mobility in a virtual AP profile (IP mobility is enabled by default). When IP mobility is enabled in a virtual AP profile, the ESSID that is configured for the virtual AP supports layer-3 mobility. If you disable IP mobility for a virtual AP, any clients that associate to the virtual AP will not have mobility service.

Configuring a Mobility Domain

You configure mobility domains on master Dell controllers. All local Dell controllers managed by the master controller share the list of mobility domains configured on the master. Mobility is disabled by default and must be explicitly enabled on all Dell controllers that will support client mobility. Disabling mobility does not delete any mobility-related configuration.

The home agent table (HAT) maps a user VLAN IP subnet to potential home agent addresses. The mobility feature uses the HAT table to locate a potential home agent for each mobile client, and then uses this information to perform home agent discovery. To configure a mobility domain, you must assign a home agent address to at least one controller with direct access to the user VLAN IP subnet. (Some network topologies may require multiple home agents.)

Dell recommends you configure the switch IP address to match the AP's local controller or define the Virtual Router Redundancy Protocol (VRRP) IP address to match the VRRP IP used for controller redundancy. Do not configure both a switch IP address and a VRRP IP address as a home agent address, or multiple home agent discoveries may be sent to the controller.



NOTE: All user VLANs that are part of a mobility domain must have an IP address that can correctly forward layer-3 broadcast multicast traffic to clients when they are away from home network.

Configure the HAT with a list of every subnetwork, mask, VLAN ID, VRRP IP, and home agent IP address in the mobility domain. Include an entry for every home agent and user VLAN to which an IP subnetwork maps. If there is more than one controller in the mobility domain providing service for the same user VLAN, you must configure an entry for the VLAN for each controller. Dell recommends using the same VRRP IP used by the AP.

The mobility domain named “default” is the default active domain for all Dell controllers. If you need only one mobility domain, you can use this default domain. However, you also have the flexibility to create one or more user-defined domains to meet the unique needs of your network topology. Once you assign a controller to a user-defined domain, it automatically leaves the “default” mobility domain. If you want a controller to belong to both the “default” and a user-defined mobility domain at the same time, you must explicitly configure the “default” domain as an active domain for the controller.

Using the WebUI

The following procedure illustrates configuring mobility domain on a master controller.

1. Navigate to the **Configuration > Advanced Services > IP Mobility** page. Select the **Enable IP Mobility** checkbox.
2. To configure the default mobility domain, select the “default” domain in the Mobility Domain list.
To create a new mobility domain, enter the name of the domain in Mobility Domain Name and click **Add**; the new domain name appears in the Mobility Domain list.
3. Select the newly-created domain name. Click **Add** under the Subnet column. Enter the subnetwork, mask, VLAN ID, VRIP, and home agent IP address and click **Add**. Repeat this step for each HAT entry.
4. Click **Apply**.

Using the CLI

The following command configures mobility domain on a master controller.

```
router mobile
```

```
ip mobile domain <name>
  hat <subnetwork> <netmask> <vlan-id> <home-agent-address> description <desc>
```

The VLAN ID must be the VLAN number on the home agent controller.

To view currently-configured mobility domains in the CLI, use the `show ip mobile domain` command.

Make sure that the ESSID to which the mobile client will connect supports IP mobility. You can disable IP mobility for an ESSID in the virtual AP profile (IP mobility is enabled by default). If you disable IP mobility for a virtual AP, any client that associates to the virtual AP will not have mobility service.

Joining a Mobility Domain

Assigning a controller to a specific mobility domain is the key to defining the roaming area for mobile clients. You should take extra care in planning your mobility domains, including surveying the user VLANs and Dell controllers to which clients can roam, to ensure that there are no roaming holes.

All Dell controllers are initially part of the “default” mobility domain. If you are using the default mobility domain, you do not need to specify this domain as the active domain on a controller. However, once you assign a controller to a user-defined domain, the “default” mobility domain is no longer an active domain on the controller.

In the WebUI

1. Navigate to the **Configuration > Advanced Services > IP Mobility** page.
2. In the Mobility Domain list, select the mobility domain.
3. Select the **Active** checkbox for the domain.
4. Click **Apply**.

In the CLI

```
ip mobile active-domain <name>
```

To view the active domains in the CLI, use the `show ip mobile active-domains` command on the controller.

Example Configuration

The following example (Figure 152) configures a network in a campus with three buildings. A Dell controller in each building provides network connections for wireless users on several different user VLANs. To allow wireless users to roam from building to building without interrupting ongoing sessions, you configure a mobility domain that includes all user VLANs on the three Dell controllers. You configure the HAT on the master controller only (controller A in this example). On the local Dell controllers (Dell controllers B and C), you only need to enable mobility.

Figure 152: Example Configuration: Campus-Wide

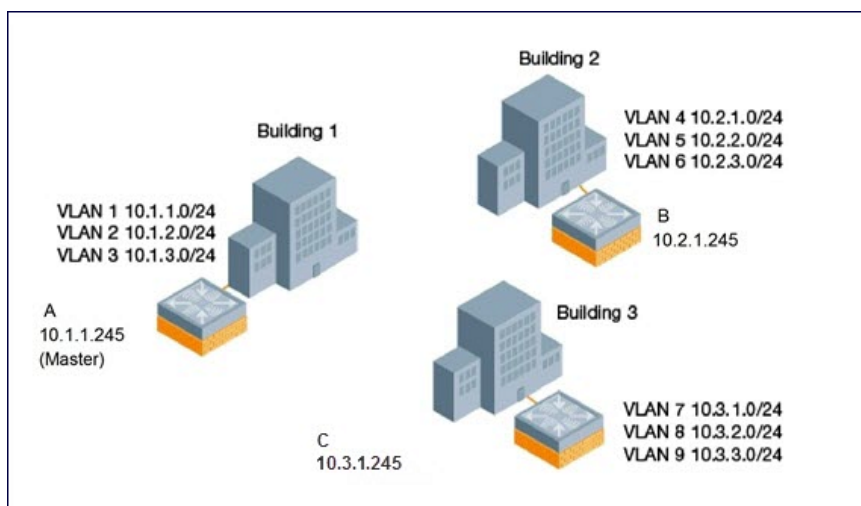

This example uses the “default” mobility domain for the campus-wide roaming area. Since all Dell controllers are initially included in the default mobility domain, you do not need to explicitly configure “default” as the active domain on each controller.

Configuring Mobility using the WebUI

On controller A (the master controller):

1. Navigate to the **Configuration > Advanced Services > IP Mobility** page.
2. Select the **Enable IP Mobility** checkbox.
3. Select the “default” domain in the Mobility Domain list.
4. Click **Add** under the Subnet column. Enter the subnetwork, mask, VLAN ID, home agent IP address, and a description for the first entry shown below and click **Add**. Repeat this step for each HAT entry.

Table 153: Example entries

Subnetwork	Mask	VLAN ID	Home Agent Address or VRIP
10.1.1.0	255.255.255.0	1	10.1.1.245
10.1.1.0	255.255.255.0	1	10.2.1.245
10.1.2.0	255.255.255.0	2	10.1.1.245
10.1.3.0	255.255.255.0	3	10.1.1.245
10.2.1.0	255.255.255.0	4	10.2.1.245
10.2.2.0	255.255.255.0	5	10.2.1.245
10.2.3.0	255.255.255.0	6	10.2.1.245
10.3.1.0	255.255.255.0	7	10.3.1.245
10.3.2.0	255.255.255.0	8	10.3.1.245
10.3.3.0	255.255.255.0	9	10.3.1.245

5. Click **Apply**.

On Dell controllers B and C:

1. Navigate to the **Configuration > Advanced Services > IP Mobility** page.
2. Select the **Enable IP Mobility** checkbox.
3. Click **Apply**.

Configuring Mobility using the CLI

On controller A (the master controller):

```
ip mobile domain default
  hat 10.1.1.0 255.255.255.0 1 10.1.1.245 description "corporate mobility entry"
  hat 10.1.1.0 255.255.255.0 1 10.2.1.245 description "local entry"
  hat 10.1.2.0 255.255.255.0 2 10.1.1.245 description "reserved reentry"
  hat 10.1.3.0 255.255.255.0 3 10.1.1.245 description "sales team"
  hat 10.2.1.0 255.255.255.0 4 10.2.1.245 description "marketing team"
  hat 10.2.2.0 255.255.255.0 5 10.2.1.245 description "test environment"
  hat 10.2.3.0 255.255.255.0 6 10.2.1.245 description "guess access"
  hat 10.3.1.0 255.255.255.0 7 10.3.1.245 description "backup"
  hat 10.3.2.0 255.255.255.0 8 10.3.1.245 description "reserved"
  hat 10.3.3.0 255.255.255.0 9 10.3.1.245 description "reserved"
router mobile
```

On Dell controllers B and C:

```
router mobile
```

Tracking Mobile Users

This section describes the ways in which you can view information about the status of mobile clients in the mobility domain.

Location-related information for users, such as roaming status, AP name, ESSID, BSSID, and physical type are consistent in both the home agent and foreign agent. The user name, role, and authentication can be different on the home agent and foreign agent, as explained by the following: Whenever a client connects to a controller in a mobility domain, layer-2 authentication is performed and the station obtains the layer-2 (logon) role. When the client roams to other networks, layer-2 authentication is performed and the client obtains the layer-2 role. If layer-3 authentication is required, this authentication is performed on the client's home agent only. The home agent obtains a new role for the client after layer-3 authentication; this new role appears in the user status on the home agent only. Even if re-authentication occurs after the station moves to a foreign agent, the display on the foreign agent still shows the layer-2 role for the user.

Mobile Client Roaming Status

You can view the list of mobile clients and their roaming status on any controller in the mobility domain:

Viewing mobile client status using the WebUI

Navigate to the **Monitoring > controller > Clients** page.

Viewing mobile client status using the CLI

```
show ip mobile host
```

Roaming status can be one of the following:

Table 154: Client Roaming Status

Roaming Status Type	Description
Home Switch/Home VLAN	This controller is the home agent for a station and the client is on the VLAN on which it has an IP address.
Mobile IP Visitor	This controller is not the home agent for a client.
Mobile IP Binding (away)	This controller is the home agent for a client that is currently away.
Home Switch/Foreign VLAN	This controller is the home agent for a client but the client is currently on a different VLAN than its home VLAN (the VLAN from which it acquired its IP address).
Stale	The client does not have connectivity in the mobility domain. Either the controller has received a disassociation message for a client but has not received an association or registration request for the client from another controller, or a home agent binding for the station has expired before being refreshed by a foreign agent.
No Mobility Service	The controller cannot provide mobility service to this client. The mobile client may lose its IP address if it obtains the address via DHCP and has limited connectivity. The mobile client may be using an IP address that cannot be served, or there may be a roaming hole due to improper configuration.

You can view the roaming status of users on any controller in the mobility domain:

Viewing user roaming status using the CLI

```
show user
```

Roaming status can be one of the following:

Table 155: User Roaming status

Status Type	Description
Associated	This client is on its home agent controller and the client is on the VLAN on which it has an IP address.
Visitor	This client is visiting this controller and the controller is not its home agent.
Away	This client is currently away from its home agent controller.
Foreign VLAN	This client is on its home agent controller but the client is currently on a different VLAN than the one on which it has an IP address.
Stale	This should be a temporary state as the client will either recover connectivity or the client's entry is deleted when the stale timer expires.

You can use the following CLI command to view the home agent, foreign agent, and roaming status for a specific mobile client.

Viewing specific client information using the CLI

```
show ip mobile trace <ip-address>|<mac-address>
```

Mobile Client Roaming Locations

You can view information about where a mobile user has been in the mobility domain. This information can only be viewed on the client's home agent.

In the WebUI

1. Navigate to the **Monitoring > controller > Clients** page.
2. Click **Status**. The mobility state section contains information about the user locations.

In the CLI

```
show ip mobile trail <ip-address>|<mac-address>
```

HA Discovery on Association

In normal circumstances a controller performs an HA discovery only when it is aware of the client's IP address which it learns through the ARP or any L3 packet from the client. This limitation of learning the client's IP and then performing the HA discovery is not effective when the client performs an inter switch move silently (does not send any data packet when in power save mode). This behavior is commonly seen with various handheld devices, Wi-Fi phones, etc. This delays HA discovery and eventually resulting in loss of downstream traffic if any meant for the mobile client.

When HA discovery on association is triggered, the foreign agent controller where the client is associated to, sends unicast request to all Dell controllers within the mobility domain to find if any one of the Dell controllers has the IP mobility state information of the client. Once this information is received, L2-GRE/IPIP tunnel is established between the foreign and home agent Dell controllers.

With HA discovery on association, a controller can perform a HA discovery as soon as the client is associated. This feature can be enabled using the `ha-disc-onassoc` parameter in the `wlan virtual <ap-profile>` command. By default, this feature is disabled. You can enable this on virtual APs with devices in power-save mode and requiring mobility. This option will also poll for all potential HAs.

Setting up mobility association Using the CLI

```
wlan virtual-ap default ha-disc-onassoc
```

Configuring Advanced Mobility Functions

You can configure various parameters that pertain to mobility functions on a controller in a mobility domain using either the WebUI or the CLI.

In the WebUI

1. Navigate to the **Configuration > Advanced Services > IP Mobility** page.
2. Select the **Global Parameters** tab.
3. Configure your desired IP mobility settings. [Table 156](#) describes the parameters you can configure on the **Global Parameters** tab.

Table 156: *IP Mobility Configuration Parameters*

Parameter	Description
General	

Parameter	Description
Encapsulation Supported	This parameter shows the type of encapsulation currently supported on the controller.
Clear Trail Entries	Clear the station location trail table. You can view entries in this table using the <code>show ip mobile trail</code> command.
Clear Mobility Counters	Clear counters for IP mobility statistics.
Foreign Agent	
lifetime	Requested lifetime, in seconds, as per RFC 3344, "IP Mobility Support for IPv4". The range of allowed values is 10-65534 seconds. The default setting is 180 seconds.
Max. Visitors Allowed	Set a maximum allowed number of active visitors. The range of allowed values for this option is 0-5000 visitors. The default setting is 5000 visitors.
Registration Requests Retransmits	Maximum number of times the foreign agent attempts mobile IP registration message exchanges before giving up. The range of allowed values for this option is 0-5 attempts. The default setting is 3 attempts.
Registration Requests Interval	Retransmission interval, in milliseconds. The range of allowed values for this option is 100-10000 milliseconds, inclusive. The default setting is 1000 milliseconds.
Home Agent	
Replay	Time difference, in seconds, for timestamp-based replay protection, as described by RFC 3344, "IP Mobility Support for IPv4". 0 disables replay. The range of allowed values is 0-5000 seconds. The default setting is 5000 seconds.
Max. Binding Allowed	Maximum number of mobile IP bindings. Note that there is a license-based limit on the number of users and a one user per binding limit in addition to unrelated users. This option is an additional limitation to control the maximum number of roaming users. When the limit is reached, registration requests from the foreign agent fail which causes a mobile client to set a new session on the visited controller, which will become its home controller. The range of allowed values is 0-300 seconds. The default setting is 7 seconds.
Proxy Mobile IP	
Trigger Mobility on Station Association	If enabled, mobility move detection is performed when the client associates with the controller instead of when the client sends packets. This option is enabled by default. Mobility on association can speed up roaming and improve connectivity for devices that do not send many uplink packets out that can trigger mobility. The downside to this option is lowered security; an association is all it takes to trigger mobility, however, this is irrelevant unless layer-2 security is enforced.
Stand Alone AP Support	Enables support for third party or standalone APs. When this is enabled, broadcast packets are not used to trigger mobility and packets from untrusted interfaces are accepted. If mobility is enabled, you must also enable standalone AP for the client to connect to the controller's untrusted port. If the controller learns wired users via the following methods, enable standalone AP: <ul style="list-style-type: none"> • Third party AP connected to the controller through the untrusted port. • Clients connected to ENET1 on the W-AP70. • Wired user connected directly to the controller's untrusted port. When IP mobility is enabled, you must also enable the Stand Alone AP Support option so that a tunneled node server can perform properly and display all wired users who are connected to a tunneled node port.

Parameter	Description
Mobility Trail Logging	Enables logging at the notification level for mobile client moves.
Roaming for Authenticated Stations Only	Allows a client to roam only if has been authenticated. If a client has not been authenticated, no mobility service is offered if it roams to a different VLAN or controller.
Blocking DHCP Release from stations	Determines whether DHCP release packets generated from the client should be dropped or forwarded to the DHCP server. Blocking the packets prevents the DHCP server from assigning the same IP address to another client until the lease has expired.
Max. Station Mobility Events per Second	Maximum number of mobility events (events that can trigger mobility) handled per second. Mobility events above this threshold are ignored. This helps to control frequent mobility state changes when the client bounces back and forth on APs before settling down. The allowed range of values is 1-65535 events, and the default value is 25 events.
Station Trail Timeout	Specifies the maximum interval, in seconds, an inactive mobility trail is held. The allowed range of values is 120-86400 seconds, and the default value is 3600 seconds.
Station Trail Max. Entries	Specifies the maximum number of entries (client moves) stored in the user mobility trail. The allowed range of values is 1-100 entries, and the default value is 30 entries.
Mobility Host Entry Hold Time	Number of seconds the mobility state is retained after the loss of connectivity. This allows authentication state and mobility information to be preserved on the home agent controller. The default is 60 seconds but can be safely increased. Note that in many case a station state is deleted without waiting for the stale timeout; user delete from management, foreign agent to foreign agent handoff, etc. (This is different from the no-service-timeout; no-service-timeout occurs up front while the stale-timeout begins when mobility service is provided but the connection is disrupted for some reason.)
Mobility Host Entry Lifetime	Time, in seconds, after which mobility service expires. If nothing has changed from the previous state, the client is given another bridge entry but it will have limited connectivity.
Proxy DHCP	
Max. BOOTP Messages per Transaction	Maximum number of BOOTP packets that are allowed to be handled during one DHCP session. The allowed range of values for tis parameter is 0-65534 packets. The default value is 25.
Max. Time Allowed per DHCP Transaction	Maximum time allowed for a proxy DHCP session to complete. The allowed range of values for this parameter is 1-600 seconds. The default value is 60 seconds.
Time to hold DHCP state after transaction completion	Hold time, in seconds, on proxy DHCP state after completion of DHCP transaction (DHCP ACK) was forwarded to the client. This option ensures that late BOOTP replies reach the station and that a retransmitted BOOTP request does not trigger a new proxy DHCP session. The allowed range of values for this parameter is 1-600 seconds. The default value is 5 seconds.
Revocation	
Retransmits	Maximum number of times the home agent or foreign agent attempts mobile IP registration/revocation message exchanges before giving up. The allowed range of values for this parameter is 0-5 retransmissions. The default value is 3 retransmissions.
Interval	Retransmission interval, in milliseconds. The allowed range of values for this parameter is 100-10000 milliseconds. The default value is 1000 milliseconds.

4. Click **Apply** after setting the parameter.

In the CLI

To configure foreign agent functionality, use the following command:

```
ip mobile foreign-agent {lifetime <seconds> | max-visitors <number> |
  registrations {interval <msecs> | retransmits <number>}}
```

To configure home agent functionality, use the following command:

```
ip mobile home-agent {max-bindings <number>|replay <seconds>}
```

To configure proxy mobile IP and DHCP functionality, use the following command:

```
ip mobile proxy
  auth-sta-roam-only | block-dhcp-release | dhcp {aggressive-transaction|ignore-options|max-
  requests <number>|transaction-hold <seconds>|transaction-timeout <seconds>}| event-
  threshold <number> | log-trail | no-service-timeout <seconds> | on-association | stale-
  timeout <seconds> | stand-alone-AP | trail-length <number> |trail-timeout <seconds>
```

To configure revocation functionality, use the following command:

```
ip mobile revocation {interval <msec>|retransmits <number>}
```

To enable packet trace for a given MAC address, use the following command:

```
ip mobile packet-trace <host MAC address>
```

Proxy Mobile IP

The *proxy mobile IP module* in a mobility-enabled controller detects when a mobile client has moved to a foreign network and determines the home agent for a roaming client. The proxy mobile IP module performs the following functions:

- Derives the address of the home agent for a mobile client from the HAT using the mobile client's IP address. If there is more than one possible home agent for a mobile client in the HAT, the proxy mobile IP module uses a discovery mechanism to find the current home agent for the client.
- Detects when a mobile client has moved. Client moves are detected based on ingress port and VLAN changes and mobility is triggered accordingly. For faster roaming convergence between AP(s) on the same controller, it is recommended that you keep the "on-association" option enabled. This helps trigger mobility as soon as 802.11 association packets are received from the mobile client.

Proxy DHCP

When a mobile client first associates with a controller, it sends a DHCP discover request with no requested IP. The controller allows DHCP packets for the client onto the configured VLAN where, presumably, it will receive an IP address. The incoming VLAN becomes the client's home VLAN.

If a mobile client moves to another AP on the same controller that places the client on a different VLAN than its initial (home) VLAN, the *proxy DHCP module* redirects packets from the client's current/visited VLAN to the home VLAN. The proxy DHCP module also redirects DHCP packets for the client from the home VLAN to the visited VLAN.

If the mobile client moves to another controller, the proxy DHCP module attempts to discover if the client has an ongoing session on a different controller. When a remote controller is identified, all DHCP packets from the client are sent to the home agent where they are replayed on the home VLAN. The proxy DHCP module also redirects DHCP packets for the client from the home VLAN to the visited network. In either situation, operations of the proxy DHCP module do not replace DHCP relay functions which can still operate on the client's home VLAN, either in the controller or in another device.

Revocations

A home agent or foreign agent can send a registration revocation message, which revokes registration service for the mobile client. For example, when a mobile client roams from one foreign agent to another, the home agent can send a registration revocation message to the first foreign agent so that the foreign agent can free any resources held for the client.

Understanding Bridge Mode Mobility Deployments

In bridge mode deployments, it is possible that more than one AP could be deployed in a single location. Therefore, APs in bridge forwarding mode support firewall session synchronization, which allows clients to retain their current session and IP address as they roam between different bridge mode APs on the same layer-2 network.

The bridge mode mobility feature facilitates client mobility on up to 32 layer-2 connected APs by allowing the APs to communicate and share user state as the user roams from AP to AP. This mechanism is always enabled when an AP is set to bridge mode, and it requires that all of the APs where roaming will occur be on the same Layer 2 segment.

Figure 157: Bridge Mode Mobility

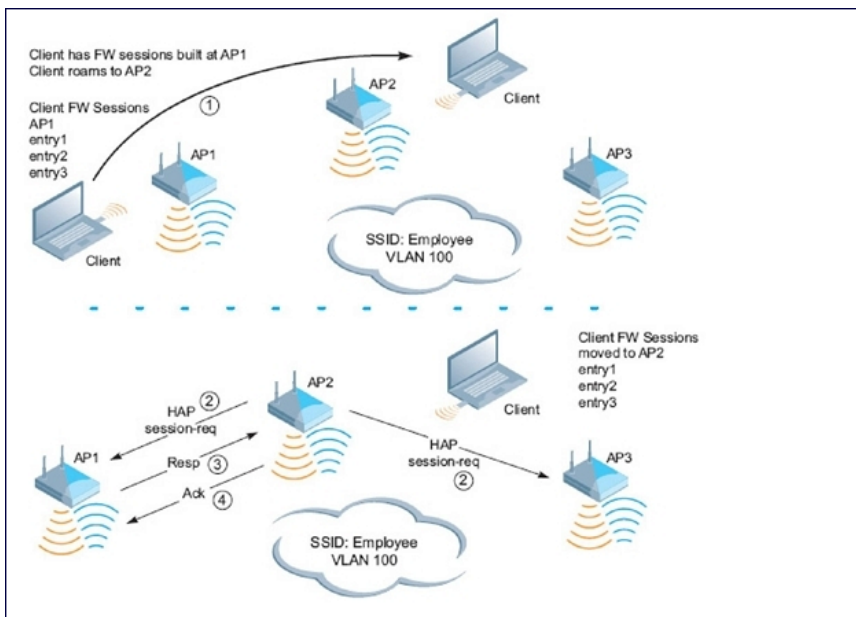

The roaming process occurs as follows:

1. A client begins to roam from AP1 and starts an association with AP2.
2. AP2 sends a broadcast message to all APs on the local layer-2 network asking if any other AP has a current session state for the roaming client.
3. Only AP1 responds to the broadcast, and sends the current session table of the client.
4. AP2 acknowledges the receipt of the session table.
5. AP1 deletes the session state of the client.
6. Roaming is complete.

Enabling Mobility Multicast

Internet Protocol (IP) multicast is a network addressing method used to simultaneously deliver a single stream of information from one sender to multiple clients on a network. Unlike broadcast traffic, which is meant for all hosts in a single domain, multicast traffic is sent only to those specific hosts who are configured to receive such traffic. Clients who want to receive multicast traffic can join a multicast group via IGMP messages. Upstream routers use IGMP message information to compute multicast routing tables and determine the outgoing interfaces for each multicast group stream.

In ArubaOS 3.3.x and earlier, when a mobile client moved away from its local network and associated with a VLAN on a foreign controller (or a foreign VLAN on its own controller) the client's multicast membership information would not be available at its new destination, and multicast traffic from the client could be interrupted. ArubaOS 3.4 and later supports mobility multicast enhancements that provide uninterrupted streaming of multicast traffic, regardless of a client's location.

Working with Proxy IGMP and Proxy Remote Subscription

The mobility controller is always aware of the client's location, so the controller can join multicast group(s) on behalf of that mobile client. This feature, called Proxy IGMP, allows the controller to join a multicast group and suppresses the client's IGMP control messages to the upstream multicast router. (The client's IGMP control messages will, however, still be used by controller to maintain a multicast forwarding table.) The multicast IGMP traffic originating from the client will instead be sent from the controller's incoming VLAN interface IP.

The IGMP proxy feature includes both a host implementation and a router implementation. An upstream router sees a controller running IGMP proxy as a host; a client attached to the controller would see the controller as router. When Proxy IGMP is enabled, all multicast clients associated with the controller are hidden from the upstream multicast device or router.

 NOTE: The newer IGMP proxy feature and the older IGMP snooping feature cannot be enabled at the same time, as both features add membership information to multicast group table. For most multicast deployments, you should enable the IGMP Proxy feature on all VLAN interfaces to manage all the multicast membership requirements on the controller. If IGMP snooping is configured on some of the interfaces, there is a greater chance that multicast information transfers may be interrupted.

IGMP proxy must be enabled or disabled on each individual interface. To use the IGMP proxy ensure that the VLANs on the Dell controllers are extended to the upstream router. Enabling IGMP proxy enables IGMP on the interface and sets the querier to the controller itself. You must identify the controller port from which the controller sends proxy join information to the upstream router, and identify the upstream router by upstream port so the controller can dynamically update the upstream multicast router information.

Working with Inter controller Mobility

When a client moves from one controller to another, multicast traffic migrates as follows:

Figure 158: Inter-controller Mobility

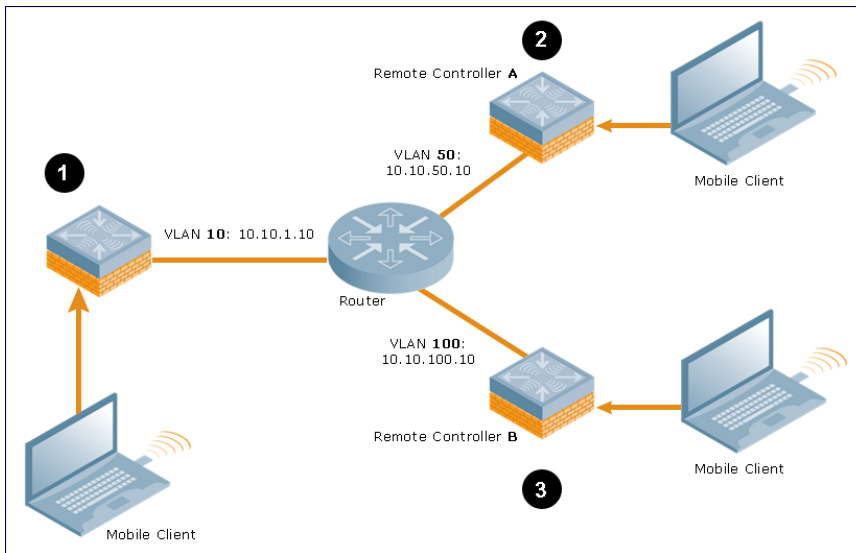

1. The local controller uses its VLAN 10 IP address to join multicast group 1 on behalf of a mobile client.
2. The mobile client leaves its local controller and roams to VLAN 50 remote controller A.

Remote controller A locates the mobile client's local controller and learns about the client's multicast groups. Remote controller A then joins group 1 on behalf the mobile client, using its VLAN 50 source IP. Upstream multicast traffic from the roaming client is sent to the local controller over an L2 GRE tunnel. the remote controller will receive downstream multicast traffic and send it to the mobile client.

NOTE: The L2-GRE Tunnel implementation of the IP mobility functionality is supported only on ArubaOS versions 6.2 or later and is not backward compatible with the earlier implementation. ArubaOS supports only v4 mobility and does not support IPv6 L3 mobility.

Meanwhile, the local controller checks to see if other local clients require group 1 traffic. If no other clients are interested in group 1, then the local controller will leave that group. If there are other clients using that group, the controller it will continue its group 1 membership.

3. Now the mobile client leaves remote controller A and roams to VLAN 100 on remote controller B. Remote controller B locates he mobile client's local controller and learns about the client's multicast groups. Remote controller B then joins group 1 on behalf the roaming mobile client 1, using its VLAN 100 IP address.

Both the local controller and remote controller A will check to see if any of their other clients require group 1 traffic. If none of their other clients are interested in group 1, then that controller will leave the group. (If the local controller leaves the group, it will also notify remote controller A.) If either controller has other clients using that group, that controller it will continue its group 1 membership.

Configuring Mobility Multicast

In the WebUI

To configure the mobility multicast feature using the controller WebUI:

1. Navigate to the **Configuration > Network > IP** window.
2. Click the **Edit** button by the VLAN interface for which you want to configure mobility multicast. The **Edit VLAN** window opens.
3. Select **Enable IGMP** to enable the router to discover the presence of multicast listeners on directly-attached links.

4. Select **Snooping** to save bandwidth and limit the sending of multicast frames to only those nodes that need to receive them.
5. Select the **Interface** checkbox, then click the **Proxy** drop-down list and select the controller interface, port and slot for which you want to enable proxy IGMP.
6. Click **Apply** to apply your changes.
7. (Optional) Repeat steps 1-6 above to configure mobility multicast for another VLAN interface.

In the CLI

The following command enables IGMP and/or IGMP snooping on this interface, or configures a VLAN interface for uninterrupted streaming of multicast traffic.

```
interface vlan <vlan>
  ip igmp proxy [{fastethernet|gigabitethernet} <slot>/<port>][snooping]
```

Table 159: Command Syntax

Parameter	Description
fastethernet	Enable IGMP proxy on the FastEthernet (IEEE 802.3) interface
gigabitethernet	Enable IGMP proxy on the GigabitEthernet (IEEE 802.3) interface
<slot>/<port> <slot>/<- module>/<port> (W- 7200 Series only)	Any command that references a Fast Ethernet or Gigabit Ethernet interface requires that you specify the corresponding port on the controller in the format <slot>/<port>. <slot> is always 1, except when referring to interfaces on the W-6000M3 controller (slots 0-3). The <port> parameter refers to the network interfaces that are embedded in the front panel of the W-3000 Series controller, or a W-6000M3 controller module. Port numbers start at 0 from the left-most position. The W-7200 Series Dell controllers use a <slot>/<module>/<port> port numbering scheme. <slot> and <module> will always be 0 on the W-7200 Series.
snooping	Enable IGMP snooping. The IGMP protocol enables an router to discover the presence of multicast listeners on directly-attached links. Enable IGMP snooping to limit the sending of multicast frames to only those nodes that need to receive them.

Example

The following example configures IGMP proxy for VLAN 2. IGMP reports from the controller would be sent to the upstream router on fastethernet port 1/3.

```
conf# interface vlan 2
  conf-subif# ip igmp proxy fastethernet 1/3
```

Chapter 29

External Firewall Configuration

In many deployment scenarios, an external firewall is situated between Dell devices. This appendix describes the network ports that need to be configured on the external firewall to allow proper operation of the Dell network. You can also use this information to configure session ACLs to apply to physical ports on the controller for enhanced security. Note, however, that this appendix does not describe requirements for allowing specific types of user traffic on the network.



NOTE: A controller uses both its loopback address and VLAN addresses for communications with other network elements. If the firewall uses host-specific ACLs, those ACLs must specify all IP addresses used on the controller.

Topics in this chapter include:

- ["Understanding Firewall Port Configuration Among Dell Devices" on page 507](#)
- ["Enabling Network Access" on page 508](#)
- ["Ports Used for Virtual Internet Access \(VIA\)" on page 508](#)
- ["Configuring Ports to Allow Other Traffic Types" on page 508](#)

Understanding Firewall Port Configuration Among Dell Devices

This section describes the network ports that need to be configured on the firewall to allow proper operation of the network.

Between any two Dell controllers:

- IPSec (UDP ports 500 and 4500) and ESP (protocol 50). PAPI between a master and a local controller is encapsulated in IPSec.
- IP-IP (protocol 94) and UDP port 443 if Layer-3 mobility is enabled.
- GRE (protocol 47) if tunneling guest traffic over GRE to DMZ controller.
- IKE (UDP 500).
- ESP (protocol 50).
- NAT-T (UDP 4500).

Between an AP and the controller:

- PAPI (UDP port 8211). If the AP uses DNS to discover the LMS controller, the AP first attempts to connect to the master controller. (Also allow DNS (UDP port 53) traffic from the AP to the DNS server.)
- PAPI (UDP port 8211). All APs running as Air Monitors (AMs) require a permanent PAPI connection to the master controller.
- FTP (TCP port 21).
- TFTP (UDP port 69) all APs, if there is no local image on the AP (for example, a new AP) the AP will use TFTP to retrieve the initial image.
- SYSLOG (UDP port 514).
- PAPI (UDP port 8211).

- GRE (protocol 47).

Between a Remote AP (IPSec) and a controller:

- NAT-T (UDP port 4500).
- TFTP (UDP port 69) .



NOTE: TFTP is not needed for normal operation. If the remote AP loses its local image for any reason, it will use TFTP to download the latest image.

Enabling Network Access

This section describes the network ports that need to be configured on the firewall to manage the Dell network.

For WebUI access between the network administrator's computer (running a Web browser) and a controller:

- HTTP (TCP ports 80 and 8888) or HTTPS (TCP ports 443 and 4343).
- SSH (TCP port 22 or TELNET (TCP port 23)).

Ports Used for Virtual Internet Access (VIA)

The following ports are used with Dell VIA.

- For the reachability/trusted network check use port 443
- For the IPSec connection use port 4500
- To allow ISAKMP use port 500

Configuring Ports to Allow Other Traffic Types

This section describes the network ports that need to be configured on the firewall to allow other types of traffic in the Dell network. You should only allow traffic as needed from these ports.

- For logging: SYSLOG (UDP port 514) between the controller and syslog servers.
- For software upgrade or retrieving system logs: TFTP (UDP port 69) or FTP (TCP ports 21 and 22) between the controller and a software distribution server.
- If the controller is a PPTP VPN server, allow PPTP (UDP port 1723) and GRE (protocol 47) to the controller.
- If the controller is an L2TP VPN server, allow NAT-T (UDP port 4500), ISAKMP (UDP port 500) and ESP (protocol 50) to the controller.
- If a third-party network management system is used, allow SNMP (UDP ports 161 and 162) between the network management system and all Dell controllers.
- For authentication with a RADIUS server: RADIUS (typically, UDP ports 1812 and 813, or 1645 and 1646) between the controller and the RADIUS server.
- For authentication with an LDAP server: LDAP (UDP port 389) or LDAPS (UDP port 636) between the controller and the LDAP server.
- For authentication with a TACACS+ server: TACACS (TCP port 49) between the controller and the TACACS+ server.
- For packet captures: UDP port 5555 from an AP to an Ethereal packet-capture station; UDP port 5000 from an AP to a Wildpackets packet-capture station.
- For telnet access: Telnet (TCP port 23) from the network administrator's computer to any AP, if "telnet enable" is present in the "ap location 0.0.0" section of the controller configuration.

- For External Services Interface (ESI): ICMP (protocol 1) and syslog (UDP port 514) between a controller and any ESI servers.
- For XML API: HTTP (TCP port 80) or HTTPS (TCP port 443) between a controller and an XML-API client.

Chapter 30

Remote Access Points

The Secure Remote Access Point Service allows AP users, at remote locations, to connect to a Dell controller over the Internet. Since the Internet is involved, data traffic between the controller and the remote AP is VPN encapsulated. That is, the traffic between the controller and AP is encrypted. Remote AP operations are supported on all of Dell's APs.

Topics in this chapter include:

- ["About Remote Access Points" on page 510](#)
- ["Configuring the Secure Remote Access Point Service" on page 512](#)
- ["Deploying a Branch Office/Home Office Solution" on page 517](#)
- ["Enabling Remote AP Advanced Configuration Options" on page 521](#)
- ["Understanding Split Tunneling" on page 535](#)
- ["Provisioning Wi-Fi Multimedia" on page 541](#)
- ["Reserving Uplink Bandwidth" on page 542](#)
- ["Provisioning 4G USB Modems on Remote Access Points" on page 543](#)
- ["Configuring W-IAP3WN Access Points" on page 545](#)
- ["Converting an IAP to RAP or CAP" on page 546](#)
- ["Enabling Bandwidth Contract Support for RAPs" on page 547](#)

About Remote Access Points

Remote APs connect to a controller using Extended Authentication and Internet Protocol Security (XAuth/IPSec). AP control and 802.11 data traffic are carried through this tunnel. Secure Remote Access Point Service extends the corporate office to the remote site. Remote users can use the same features as corporate office users. For example, voice over IP (VoIP) applications can be extended to remote sites while the servers and the PBX remain secure in the corporate office.

Secure Remote Access Point Service can also be used to secure control traffic between an AP and the controller in a corporate environment. In this case, both the AP and controller are in the company's private address space.

The remote AP must be configured with the IPSec VPN tunnel termination point. Once the VPN tunnel is established, the AP bootstraps and becomes operational. The tunnel termination point used by the remote AP depends upon the AP deployment, as shown in the following scenarios:

- **Deployment Scenario 1:** The remote AP and controller reside in a private network which is used to secure AP-to-controller communication. (Dell recommends this deployment when AP-to-controller communications on a private network need to be secured.) In this scenario, the remote AP uses the controller's IP address on the private network to establish the IPSec VPN tunnel.

Figure 160: Remote AP with a Private Network

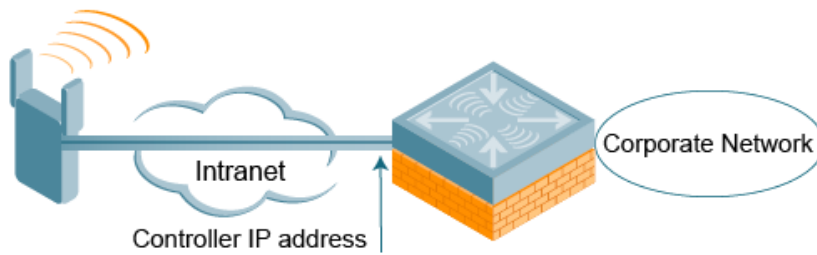

- Deployment Scenario 2: The remote AP is on the public network or behind a NAT device and the controller is on the public network. The remote AP must be configured with the tunnel termination point which must be a publicly-routable IP address. In this scenario, a routable interface is configured on the controller in the DMZ. The remote AP uses the controller's IP address on the public network to establish the IPSec VPN tunnel.

Figure 161: Remote AP with Controller on Public Network

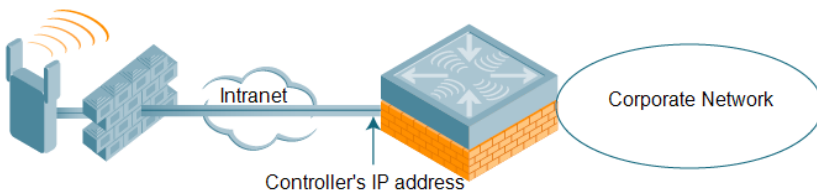

- Deployment Scenario 3: The remote AP is on the public network or behind a NAT device and the controller is also behind a NAT device. (Dell recommends this deployment for remote access.) The remote AP must be configured with the tunnel termination point which must be a publicly-routable IP address. In this scenario, the remote AP uses the public IP address of the corporate firewall. The firewall forwards traffic to an existing interface on the controller. (The firewall must be configured to pass NAT-T traffic (UDP port 4500) to the controller.)

Figure 162: Remote AP with Controller Behind Firewall

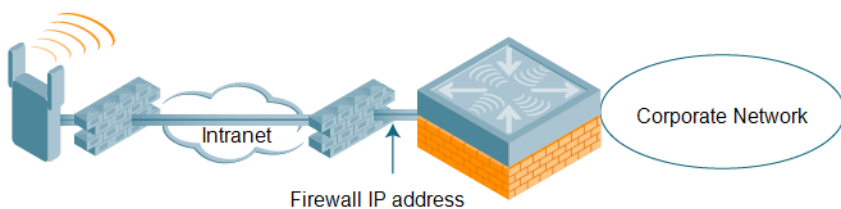

In any of the described deployment scenarios, the IPSec VPN tunnel can be terminated on a local controller, with a master controller located elsewhere in the corporate network (Figure 163). The remote AP must be able to communicate with the master controller after the IPSec tunnel is established. Make sure that the L2TP IP pool configured on the local controller (from which the remote AP obtains its address) is reachable in the controller network by the master controller.

Figure 163: Remote AP in a Multi-Controller Environment

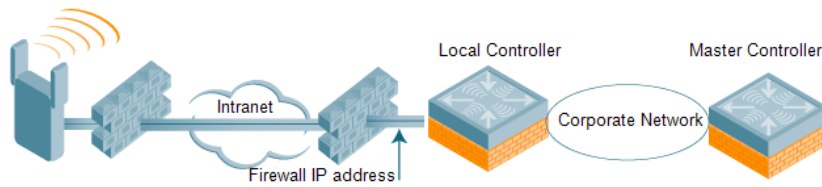

Configuring the Secure Remote Access Point Service

The tasks for configuring a Dell Access Points as a Secure Remote Access Point Service are:

- Configure a public IP address for the controller.
You must install one or more AP licenses in the controller. There are several AP licenses available that support different maximum numbers of APs. The licenses are cumulative; each additional license installed increases the maximum number of APs supported by the controller.
- Configure the VPN server on the controller. The remote AP will be a VPN client to the server.
- Provision the AP with IPSec settings, including the username and password for the AP, before you install it at the remote location. You can also provision the RAP using the zero-touch provisioning method. For more information, see ["Provisioning 4G USB Modems on Remote Access Points" on page 543](#).

Configure a Public IP Address for the Controller

The remote AP requires an IP address to which it can connect in order to establish a VPN tunnel to the controller. This can be either a routable IP address that you configure on the controller, or the address of an external router or firewall that forwards traffic to the controller. The following procedure describes how to create a DMZ address on the controller.

Using the WebUI to create a DMZ address

1. Navigate to the **Configuration > Network > VLANs** page.
2. Click **Add** to add a VLAN.
3. Enter the VLAN ID.
4. Select the port that belongs to this VLAN.
5. Click **Apply**.
6. Navigate to the **Configuration > Network > IP** page.
7. Click **Edit** for the VLAN you just created.
8. Enter the IP Address and Net Mask fields.
9. Click **Apply**.

Using CLI

```
vlan <id>
interface fastethernet <slot>/<port>
  switchport access vlan <id>
interface vlan <id>
  ip address <ipaddr> <mask>
```

Configure the NAT Device

Communication between the AP and secure controller uses the UDP 4500 port. When both the controller and the AP are behind NAT devices, configure the AP to use the NAT device's public address as its master address. On the

NAT device, you must enable NAT-T (UDP port 4500 only) and forward all packets to the public address of the NAT device on UDP port 4500 to the controller to ensure that the remote AP boots successfully.

Configure the VPN Server

This section describes how to configure the IPSec VPN server on the controller. For more details, see [Virtual Private Networks on page 271](#). The remote AP will be a VPN client that connects to the VPN server on the controller.

Using the WebUI

1. Navigate to the **Configuration > Advanced Services > VPN Services > IPSec** page.
2. Select (check) **Enable L2TP**.
3. Make sure that **PAP** (Password Authentication Protocol) is selected for **Authentication Protocols**.
4. To configure the L2TP IP pool, click **Add** in the **Address Pools** section. Configure the L2TP pool from which the APs will be assigned addresses, then click **Done**.



NOTE: The size of the pool should correspond to the maximum number of APs that the controller is licensed to manage.

5. To configure an Internet Security Association and Key Management Protocol (ISAKMP) encrypted subnet and preshared key, click **Add** in the **IKE Shared Secrets** section and configure the preshared key. Click **Done** to return to the IPSec page.
6. Click **Apply**.

Using CLI

```
vpdn group l2tp
  ppp authentication PAP

ip local pool <pool> <start-ipaddr> <end-ipaddr>
crypto isakmp key <key> address <ipaddr> netmask <mask>
```

CHAP Authentication Support over PPPoE

RAPs can now establish a PPPoE session with a PPPoE server at the ISP side and get authenticated using the Challenge Handshake Authentication Protocol (CHAP). The PPPoE client running on a RAP is capable of handling the CHAP authentication requests from the PPPoE server.



NOTE: The PPPoE client selects either the PAP or the CHAP credentials for the RAP authentication depending upon the request from the PPPoE server.

You can use the CLI or the WebUI to configure CHAP.

Using the WebUI to configure CHAP

1. Navigate to the **Configuration > Wireless > AP Installation** page. The list of discovered APs are displayed on this page.
2. Select the AP you want to configure using CHAP and click **Provision** button.
3. Enter the **CHAP Secret** in the text box under **Authentication Method**.



NOTE: You can use all the special characters except question mark (?) and the space can be used within double quotes (" ").

4. Enter the CHAP Secret again in the **Confirm CHAP Secret** text box for confirmation.

Figure 164: CHAP Authentication Using CHAP Secret

The screenshot shows the 'Authentication Method' configuration page. Key sections include:
- **Remote AP:** Radio buttons for 'Yes' (selected) and 'No'.
- **Remote AP Authentication Method:** Radio buttons for 'Pre-shared Key' and 'Certificate' (selected).
- **User credential assignment:** A dropdown menu with 'Global User Name/Password' and 'per AP User Name/Password' (selected).
- **PPPoE Parameters:** Fields for 'Service Name', 'User Name', and 'Password'.
- **CHAP Secret:** A text input field and a 'Confirm CHAP Secret' field, both highlighted with red boxes.

5. Click **Apply and Reboot**.

Using the CLI to configure the CHAP

```
provision-ap pppoe-chap-secret <KEY>  
reprovision ap-name <name>
```

Configuring Certificate RAP

You can configure the remote AP to use the internal certificate for authentication. You can use the WebUI or CLI to configure the certificate RAP.

Using WebUI

1. Navigate to **Configuration > AP Installation** (under **Wireless**).
2. Select the required remote AP under the **Provisioning** tab and then click **Provision**.
3. Select **Yes** for Remote AP and **Certificate** for Remote AP Authentication Method.
4. Click **Apply and Reboot** to apply the configuration and reboot the AP as certificate RAP.

Using CLI

```
local-userdb-ap add <mac-address>
```

Creating a Remote AP Whitelist

If you are using the zero-touch provisioning method to provision the certificate RAP, then you must create a remote AP whitelist. For more information on zero-touch provisioning of the RAP, see ["Provisioning 4G USB Modems on Remote Access Points" on page 543](#).

Remote AP whitelist is the list of approved APs that can be provisioned on your controller. To create a remote AP whitelist:

1. Navigate to **Configuration > AP Installation** (under **Wireless**) and then click the **RAP Whitelist** tab on the right side.
2. Click the **New** button and provide the following details:
 - **AP MAC Address**—Mandatory parameter. Enter the MAC address of the AP.
 - **Username**—Enter a username that will be used when the AP is provisioned.
 - **AP Group**—Select a group to add the AP.
 - **AP Name**—Enter a name for the AP. If an AP name is not entered, the MAC address will be used instead.
 - **Description**—Enter a text description for the AP
 - **IP-Address**—Enter an IP address for the AP.
3. Click the **Add** button to add the remote AP to the whitelist.

Configuring PSK RAP

You can use Pre-Shared Key (PSK) authentication to provision an individual remote AP or a group of remote APs using an Internet Key Exchange Pre-Shared Key (IKE PSK).

To configure the PSK RAP using the WebUI:

1. Navigate to the **Configuration > Wireless > AP Installation > Provisioning** window.
2. Click the checkbox by the AP you want to provision, then click **Provision**. The Provisioning window opens.
3. Select **Yes** for the **Remote AP** option
4. In the **Remote IP Authentication Method** section, select **Pre-shared key**.
5. Enter and confirm the pre-shared key (IKE PSK).
6. In the **User credential assignment** section, specify if you want to use a **Global User Name/password** or a **Per AP User Name/Password**.
 - a. If you use the **Per AP User Names/Passwords** option, each RAP is given its own user name and password.
 - b. If you use the **Global User Name/Password** option, all selected RAPs are given the same (shared) user name and password.
7. Enter the user name, and enter and confirm the password. If you want the controller to automatically generate a user name and password, select **Use Automatic Generation**, then click **Generate by the User Name and Password** fields.

Add the user to the internal database

You can add the user to the internal database using the WebUI or CLI.

Using WebUI

1. Navigate to the **Configuration > Security > Authentication > Servers** page.
2. Select **Internal DB**.
3. Click **Add User** in the Users section. The user configuration page displays.
4. Enter the user name and password.
5. Click **Enabled** to activate this entry on creation.
6. Click **Apply** to apply the configuration. Note that the configuration does not take effect until you perform this step.
7. At the **Servers** page, click **Apply**.

Using CLI

```
local-userdb add username rapuser1 password <password>
```

RAP Static Inner IP Address

The RAP static inner IP address feature assigns a static inner IP address to a remote access point (RAP). A new *remote-IP address* parameter is added to the existing configuration commands.

Using the WebUI

To view IP address parameter in the local database, navigate to the **Configuration > Security > Authentication > Servers > Internal DB** page.

Figure 165: IP-Address parameter in the local database

User Name	Password	Role	E-mail	Enabled	Expiry	IP-Address	Action
Test	*****	authenticated		Yes		1.2.3.4	Disable Delete Modify
rapuser	*****	ap-role		Yes		0.0.0.0	Disable Delete Modify
sidd	*****	guest		Yes		0.0.0.0	Disable Delete Modify
guest-6381449	*****	guest		Yes		0.0.0.0	Disable Delete Modify

To view IP-address parameter in the RAP Whitelist, navigate to the **Wireless > AP Installation > RAP Whitelist** page.

Figure 166: IP-Address parameter in the RAP Whitelist

AP MAC Address	User Name	AP Group	AP Name	Description	Revoked	IP-Address
<input type="checkbox"/> 00:1a:1e:c0:b3:54	q	CP_TEST	AP-125-Port-2	wq		0.0.0.0
<input type="checkbox"/> 00:0b:06:66:02:a9	sid-user	CP_TEST	AP-rap5-port-10	desc		0.0.0.0
<input type="checkbox"/> 11:22:33:44:55:aa	test	grp-4whitelist	testing	test desc		0.0.0.0
<input type="checkbox"/> ab:cd:ef:11:22:33	aa	New-Group12	12	123		0.0.0.0

Using the CLI

```
local-userdb add {generate-username|username <name>} {generate-password|password
<password>} {remote-ip <remote-ip>}
local-userdb modify {username <name>} {remote-ip <remote-ip>}
local-userdb-ap add {mac-address <address>}{ap-group <ap_group>}{remote-ip <remote-ip>}
local-userdb-ap modify {mac-address <address>} {remote-ip<remote-ip>}
```

NOTE: You cannot configure the IP-Address parameter using the WebUI.

Provision the AP

You need to configure the VPN client settings on the AP to instruct the AP to use IPSec to connect to the controller. You can provision the remote AP and give it to users and allow remote users to provision AP at their home. This method of provisioning is referred as Zero-touch provisioning. See ["Provisioning 4G USB Modems on Remote Access Points" on page 543](#) for more information about zero-touch provisioning of remote AP.

You must provision the AP before you install it at its remote location. To provision the AP, the AP must be physically connected to the local network or directly connected to the controller. When connected and powered on, the AP must also be able to obtain an IP address from a DHCP server on the local network or from the controller.

If your configuration has an internal LMS IP address, remote APs may attempt to switch over to the LMS IP address, which is not reachable from the Internet. For remote APs, ensure that the LMS IP address in the AP system profile for the AP group has an externally routable IP address.

Reprovisioning the AP causes it to automatically reboot. The easiest way to provision an AP is to use the Provisioning page in the WebUI, as described in the following steps:

1. Navigate to the **Configuration > Wireless > AP Installation > Provisioning** page. Select the remote AP and click **Provision**.
2. Under Authentication Method, select IPSec Parameters. Enter the Internet Key Exchange (IKE) Pre-Shared Key (PSK), username, and password.

NOTE: The username and password you enter must match the username and password configured on the authentication server for the remote AP

3. Under Master Discovery, set the Master IP Address as shown below:

Deployment Scenario	Master IP Address Value
Deployment 1	Controller IP address
Deployment 2	Controller public IP address
Deployment 3	Public address of the NAT device to which the controller is connected



NOTE: The username and password you enter must match the username and password configured on the authentication server for the remote AP

- Under IP Settings, make sure that Obtain IP Address Using DHCP is selected.
- Click Apply and Reboot.

Deploying a Branch Office/Home Office Solution

In a branch office, the AP is deployed in a separate IP network from the corporate network. Typically, there are one or two NAT devices between the two networks. Branch office users need access to corporate resources like printers and servers but traffic to and from these resources must not impact the corporate head office.

The [Figure 167](#) is a graphic representation of a remote AP in a branch or home office with a single controller providing access to both a corporate WLAN and a branch office WLAN.

Figure 167: Remote AP with Single Controller

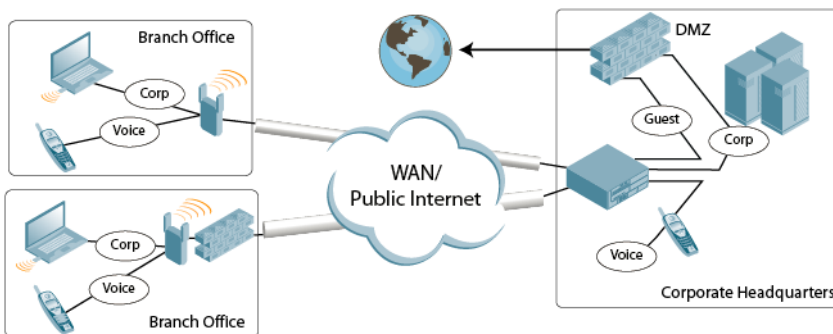

Branch office users want continued operation of the branch office WLAN even if the link to the corporate network goes down. The branch office AP solves these requirements by providing the following capabilities on the branch office WLAN:

- Local termination of 802.11 management frames which provides survivability of the branch office WLAN.
- All 802.1x authenticator functionality is implemented in the AP. The controller is used as a RADIUS pass-through when the authenticator has to communicate with a RADIUS server (which also supports survivability).
- 802.11 encryption/decryption is in the AP to provide access to local resources.
- Local bridging of client traffic connected to the WLAN or to an AP 70 enet1 port to provide access to local resources.

Provisioning the Branch Office AP

You can provision the remote AP either using the controller or using the zero-touch provisioning method. For more information on controller provisioning, see ["Provisioning Installed APs" on page 409](#). For more information on zero-touch provisioning, see ["Provisioning 4G USB Modems on Remote Access Points" on page 543](#).

Configuring the Branch Office AP

- Specify forward mode for the Extended Service Set Identifier (ESSID) in the virtual AP profile
- Specify remote AP operation in the virtual AP profile (by default, the remote AP operates in standard mode)
- Set how long the AP stays up after connectivity to controller has gone down in the SSID profile
- Set the VLAN ID in the virtual AP profile
- Set the native VLAN ID in the AP system profile
- Set forward mode for enet1 port



NOTE: Remote APs support 802.1q VLAN tagging. Data from the remote AP will be tagged on the wired side.

Troubleshooting Remote AP

The following WebUI options are available to troubleshoot issues with remote AP:

- Using local debugging feature
- Viewing the remote AP summary report
- Viewing remote AP connectivity report
- Using remote AP diagnostic options

Local Debugging

Local Debugging is a WebUI feature that allows end users to perform diagnostics and view the status of their remote AP through a wired or wireless client. This feature is useful for troubleshooting connectivity problems on remote AP and to performing throughput tests. There are three tabs in the Local Debugging WebUI window, **Summary**, **Connectivity** and **Diagnostics**. Each tab displays different information for the AP, but all three tabs include a **Generate & save support file** link that, when clicked, will automatically generate a **support.tgz** file that can be sent to a corporate IT department for additional analysis and debugging.



NOTE: Starting from Dell PowerConnect W-Series ArubaOS 6.2, snapshot of the bridge, acl, session, user, and arp tables, current processes, memory, and kernel debug messages are captured in a single **rap_debug.txt** file which is bundled along with **support.tgz** file.

Remote AP Summary

The **Summary** tab has two views; basic and advanced. Click the **basic** or **advanced** links at the top of this tab to toggle between the two views. The table below shows the information displayed for both the basic and advanced views of the **Summary** tab.

Table 168: RAP Console Summary Tab Information

Summary Table Name	Basic View Information	Advanced View Information
Wired Ports Status	<ul style="list-style-type: none"> ● Port: Port numbers of the wired ports on the AP. ● Status: Current status of each port (<i>Connected</i>, <i>LinkDown</i> or <i>Disabled</i>). 	<p>The advanced view of the Wired Access Ports table displays the following data:</p> <ul style="list-style-type: none"> ● Port: Port numbers of the wired ports on the AP. ● Status: Current status of each port (<i>Connected</i>, <i>LinkDown</i> or <i>Disabled</i>). ● MAC Address: MAC address of the wired port. ● Speed: Speed of the link. ● Duplex Type: Duplex mode of the link, full or half. ● Forwarding mode: Forwarding mode for the port: <i>Bridge</i>, <i>Tunnel</i> or <i>Split Tunnel</i>. ● Users: Number of users accessing each port. ● Rx Packets: Number of packets received on the port. ● Tx packets: Number of packets transmitted via the port.
Wireless SSIDs	<ul style="list-style-type: none"> ● SSID: Name of the SSID. ● Status: SSID Status (up, down, or disabled). ● Band: Radio band available on the SSID. 	<ul style="list-style-type: none"> ● SSID: Name of the SSID. ● Status: SSID Status (up, down, or disabled). ● Band: Radio band available on the SSID. ● Channel: Channel used on the radio band. ● BSSID: BSSID of the wireless SSID. ● Forwarding Mode: Forwarding mode used by the Wireless SSID (<i>Bridge</i>, <i>Tunnel</i> or <i>Split-Tunnel</i>). ● EIRP: Equivalent Isotropic Radiated Power, in dBm. ● Noise floor: The residual background noise detected by an AP. Noise seen by an AP is reported as -dBm. Therefore, a noise floor of -100 dBm is smaller (lower) than a noise floor of -50 dBm. ● Users: Number of users on the radio band. ● Rx Packets: Number of packets received on the BSSID. ● Tx packets: Number of packets transmitted via the BSSID.
Wired Users	<ul style="list-style-type: none"> ● MAC Address: MAC address of the wired user. ● IP address: IP address of the wired user. 	<ul style="list-style-type: none"> ● MAC Address: MAC address of the wired user. ● IP address: IP address of the wired user. ● Port: AP port used by the wired user.
Wireless User	<ul style="list-style-type: none"> ● MAC Address: MAC address of the wireless user. ● IP address: IP address of the wireless user. 	<ul style="list-style-type: none"> ● MAC Address: MAC address of the wired user. ● IP address: IP address of the wired user. ● SSID: Name of the SSID. ● BSSID: BSSID of the wireless user. ● Assoc State: Shows if the user is associated or just authorized. ● Auth: Type of authentication: WPA, 802.1x, none, open, or shared. ● Encryption: Encryption type used by the wireless user.

Summary Table Name	Basic View Information	Advanced View Information
		<ul style="list-style-type: none"> ● Band: Radio band used by the wireless client. ● RSSI: The Receive Signal Strength Indicator (RSSI) value displayed in the output of this command represents signal strength as a signal to noise ratio.
Device Info	<ul style="list-style-type: none"> ● Type: AP device/model type. ● Name: Name assigned to the AP. ● Wired MAC address: MAC address of the wired port. ● Serial #: AP serial number. ● Tunnel IP address: IP address of the tunnel between the AP and controller. ● Software Version: Software version currently running on the AP. ● Uptime: Amount of time the AP has been active since it was last reset. ● Master: IP address of the master controller. ● lms: IP address of the local controller. 	N/A
Uplink Info	<p>The Uplink Info table can display some or all of the following information for your remote AP, depending upon whether a link is active and the number of links supported by the AP.</p> <p>Active uplink information, including:</p> <ul style="list-style-type: none"> ● Interface name ● Port speed ● IP address <p>Standby link information, including:</p> <ul style="list-style-type: none"> ● Name (3G) ● Device connected (yes/no) ● Provisioned (yes/no) ● IP address ● Device ● User ● Password 	N/A

Multihoming on remote AP (RAP)

You can uplink a RAP as an Ethernet or a USB based modem. These uplinks can be used as a backup link if the primary link fails. The uplink becomes active based on the order of the priority configured on the RAP. The RAP switches back to the primary link when the primary connection is restored.

For information on provisioning the RAP using the USB based modem, see [Provisioning 4G USB Modems on Remote Access Points on page 543](#).

Seamless failover from backup link to primary link on RAP

RAPs can failover from a backup link to a primary link without much disruption to traffic. Also the failover is performed only if the controller is reachable via the primary link.

Remote AP Connectivity

The information shown on the **Connectivity** tab will vary, depending upon the current status of the remote AP. If a remote AP has been successfully provisioned and connected, it should display some or all of the information in [Table 169](#).

Table 169: RAP Console Connectivity Tab Information

Data	Description
Uplink status	Shows if the link connected failed. If the link is connected, the Uplink status also displays the name of the interface.
IP Information	If the AP has successfully received an IP address, this data row will show the AP's IP address, subnet mask, and gateway IP address.
Gateway Connectivity	If successful, this item also shows the percentage of packet loss for data received from the gateway
TPM Certificates	If successful, the AP has a Trusted Platform Module (TPM) certificate.
Master Connectivity	Shows if the AP was able to connect to the master controller. This item also shows the IP address to which the AP attempted to connect, and, if the AP did connect successfully, the link that was used to connect to that controller.
LMS Connectivity	Shows if the AP was able to connect to a local controller. This item also shows the IP address to which the AP attempted to connect, and, if the AP did connect successfully, the link that was used to connect to that controller.

The top of the **Connectivity** tab has a **Refresh** link that allows users to refresh the data on their screen. Additional information at the bottom of this tab shows the date, time and reason the remote AP last rebooted. The **Reboot RAP Now** button reboots the remote AP.

Remote AP Diagnostics

Use the **Diagnostics** tab to view log files, or run diagnostic tests that can help the IT department troubleshoot errors. You can also use the **Reboot AP Now** button at the bottom of the Diagnostic window reboots the remote AP.

To run a diagnostic test on a remote AP:

1. Access the RAP console, and click the **Diagnostics** tab
2. Click the **Test** drop-down list and select **Ping**, **Traceroute**, **NSLookup** or **Throughput**.

The *ping* and *traceroute* tests require that you enter a network destination in the form of an IP address or fully-qualified domain name, and select either **bridge** or **tunnel** mode for the test. The *NSLookup* diagnostic test requires that you enter a destination only. The *throughput* test checks the throughput of the link between the AP and the controller, and does not require any additional test configuration settings.

3. Click **OK** to start the test. The results of the test will appear in the **Diagnostics** window.

To display log files in a separate browser window, click the **logs** drop-down list at the upper right corner of the Diagnostics window, and select any of the log file name. The type of log files available will vary, depending upon your remote AP configuration.

Enabling Remote AP Advanced Configuration Options

This section describes the following features designed to enhance your remote AP configuration:

- ["Understanding Remote AP Modes of Operation" on page 522](#)
- ["Working in Fallback Mode" on page 523](#)
- ["Specifying the DNS Controller Setting" on page 531](#)
- ["Backup Controller List " on page 532](#)
- ["Configuring Remote AP Failback" on page 533](#)

- "Working with Access Control Lists and Firewall Policies" on page 535
- "Understanding Split Tunneling" on page 535
- "Provisioning Wi-Fi Multimedia" on page 541



NOTE: The information in this section assumes you have already configured the remote AP functionality, as described "Configuring the Secure Remote Access Point Service" on page 512.

Understanding Remote AP Modes of Operation

Table 170 summarizes the different remote AP modes of operation. You specify both the forward mode setting (which controls whether 802.11 frames are tunneled to the controller using GRE, bridged to the local Ethernet LAN, or a combination thereof) and the remote AP mode of operation (when the virtual AP operates on a remote AP) in the virtual AP profile.

The column on the left of the table lists the remote AP operation settings. The row across the top of the table lists the forward mode settings. To understand how these settings work in concert, scan the desired remote AP operation with the forward mode setting and read the information in the appropriate table cell.

The "all" column and row lists features that all remote AP operation and forward mode settings have in common regardless of other settings. For example, at the intersection of "all" and "bridge," the description outlines what happens in bridge mode regardless of the remote AP mode of operation.

Table 170: Remote AP Modes of Operation and Behavior

Remote AP Operation Setting	Forward Mode Setting				
	all	bridge	split-tunnel	tunnel	decrypt-tunnel
all		Management frames on AP. Frames are bridged between wired and wireless interfaces. No frames are tunneled to the controller. Station acquires its IP address locally from an external DHCP server.	Management frames on AP. Frames are either GRE tunneled to the controller to a trusted tunnel or NATed and bridged on the wired interface according to user role and session ACL. Typically, the station obtains an IP address from a VLAN on the controller. Typically, the AP has ACLs that forward corporate traffic through the tunnel and source NAT the non-corporate traffic to the Internet.	Frames are GRE tunneled to the controller to an untrusted tunnel. 100% of station frames are tunneled to the controller.	Management frames on AP. Frames are always GRE tunneled to controller.

Remote AP Operation Setting					
Forward Mode Setting					
always	ESSID is always up when the AP is up regardless if the controller is reachable. Supports PSK ESSID only. SSID configuration stored in flash on AP.	Provides an SSID that is always available for local access.	Not supported	Not supported	Not supported
	all	bridge	split-tunnel	tunnel	
backup	ESSID is only up when controller is unreachable. Supports PSK ESSID only. SSID configuration stored in flash on AP.	Provides a backup SSID for local access only when the controller is unreachable.	Not supported	Not supported	Not supported
persistent	ESSID is up when the AP contacts the controller and stays up if connectivity is disrupted with the controller. SSID configuration obtained from the controller. Designed for 802.1x SSIDs.	Same behavior as standard, described below, except the ESSID is up if connectivity to the controller is lost.	Not supported	Not supported	Not supported
standard	ESSID is up only when there is connectivity with the controller. SSID configuration obtained from the controller.	Behaves like a classic Dell branch office AP. Provides a bridged ESSID that is configured from the controller and stays up if there is controller connectivity.	Split tunneling mode.	Classic Dell thin AP operation.	Decrypt tunnel mode

Working in Fallback Mode

The fallback mode (also known as backup configuration) operates the remote AP if the master controller or the configured primary and backup LMS are unreachable. The remote AP saves configuration information that allows it to operate autonomously using one or more SSIDs in local bridging mode while supporting open association or encryption with PSKs. You can also use the backup configuration if you experience network connectivity issues, such as the WAN link or the central data center becomes unavailable. With the backup configuration, the remote site does not go down if the WAN link fails or the data center is unavailable.

You define the backup configuration in the virtual AP profile on the controller. The remote AP checks for configuration updates each time it establishes a connection with the controller. If the remote AP detects a change, it downloads the configuration changes.

The following remote AP backup configuration options define when the SSID is advertised (refer to [Table 170](#) for more information):

- **Always**—Permanently enables the virtual AP. Recommended for bridge SSIDs.
- **Backup**—Enables the virtual AP if the remote AP cannot connect to the controller. This SSID is advertised until the controller is reachable. Recommended for bridge SSIDs.
- **Persistent**—Permanently enables the virtual AP after the remote AP initially connects to the controller. Recommended for 802.1x SSIDs.
- **Standard**—Enables the virtual AP when the remote AP connects to the controller. Recommended for 802.1x, tunneled, and split-tunneled SSIDs. This is the default behavior.

While using the backup configuration, the remote AP periodically retries its IPsec tunnel to the controller. If you configure the remote AP in backup mode, and a connection to the controller is re-established, the remote AP stops using the backup configuration and immediately brings up the standard remote AP configuration. If you configure the remote AP in always or persistent mode, the backup configuration remains active after the IPsec tunnel to the controller has been re-established.

Backup Configuration Behavior for Wired Ports

If the connection between remote AP and the controller is disconnected, the remote AP will exhibit the following behavior:

- All access ports on the remote AP, irrespective of their original forwarding mode will be moved to bridge forwarding mode.
- Clients will receive IP address from the remote AP's DHCP server.
- Client will have complete access to Remote AP's uplink network. You cannot enforce or modify any access control policies on the clients connected in this mode.

This section describes the following topics:

- ["Configuring Fallback Mode" on page 524](#)
- ["Configuring the DHCP Server on the Remote AP " on page 526](#)
- ["Configuring Advanced Backup Options" on page 528](#)

Configuring Fallback Mode

To configure the fallback mode, you must

- Configure the AAA profile.
- Configure the virtual AP profile

Configuring the AAA Profile for Fallback Mode in the WebUI

The AAA profile defines the authentication method and the default user role for unauthenticated users.

1. Navigate to the **Security > Authentication > AAA Profiles** page. From the AAA Profiles Summary list, click **Add**.
2. Enter the AAA profile name, then click **Add**.
3. Select the AAA profile that you just created:
 - a. For Initial role, select the appropriate role (for example, "logon").
 - b. For 802.1X Authentication Default Role, select the appropriate role (for example, "default"), then click **Apply**.

- c. Under the AAA profile that you created, locate 802.1x Authentication Server Group, and select the authentication server group to use (for example “default”), then click **Apply**.



NOTE: If you need to create an 802.1x authentication server group, select new from the 802.1X Authentication Server Group drop-down list, and enter the appropriate parameters.

- d. Under the AAA profile that you created, locate 802.1X Authentication Profile, and select the profile to use (for example, “default”), then click **Apply**.



NOTE: If you need to create an 802.1x authentication profile, select new from the 802.1X Authentication Profile drop-down list, and enter the appropriate parameters.

Configuring the AAA Profile for Fallback Mode in the CLI

```
aaa profile <name>
  initial-role <role>
  authentication-dot1x <dot1x-profile>
  dot1x-default-role <role>
  dot1x-server-group <group>
```

Configuring the Virtual AP Profile for Fallback Mode in the WebUI

To configure virtual AP profile:

- Set the remote AP operation to “always,” “backup,” or “persistent.”
- Create and apply the applicable SSID profile.

The SSID profile for the backup configuration in always, backup, or persistent mode must be a bridge SSID. When configuring the virtual AP profile, specify forward mode as “bridge.”

The SSID profile for the backup configuration in standard mode can be a bridge, tunnel, or split tunnel SSID. When configuring the virtual AP profile, specify forward mode as “bridge,” “tunnel,” or “split tunnel.”



NOTE: When creating a new virtual AP profile in the WebUI, you can also configure the SSID at the same time. For information about AP profiles, see ["Understanding AP Configuration Profiles" on page 396](#).

1. Navigate to the **Configuration > Wireless > AP Configuration** page. Select either the AP Group or AP Specific tab. Click **Edit** for the AP group or AP name.
2. Under Profiles, select **Wireless LAN**, then **Virtual AP**.
3. To create a new virtual AP profile in the WebUI, select **New** from the **Add a profile** drop-down menu. Enter the name for the virtual AP profile, and click **Add**.



NOTE: Whenever you create a new virtual AP profile in the WebUI, the profile automatically contains the “default” SSID profile with the default ESSID. You must configure a new ESSID and SSID profile for the virtual AP profile before you apply the profile.

- a. In the Profile Details entry for the new virtual AP profile, go to the **AAA Profile** drop-down list and select the previously configured AAA profile (for example, “logon”). The AAA Profile pop-up window appears.
- b. To set the AAA profile and close the pop-up window, Click **Apply**.
- c. In the Profile Details entry for the new virtual AP profile, select **NEW** from the **SSID Profile** drop-down menu. The SSID Profile pop-up window displays to allow you to configure the SSID profile.
- d. Enter the name for the SSID profile (for example, “backup”).
- e. Under Network, enter a name in the Network Name (SSID) field (for example, “backup-psk”).

- f. Under Security, select the network authentication and encryption methods (for example, wpa-psk-tkip, with the passphrase “remotel23”).
 - g. To set the SSID profile and close the pop-up window, click **Apply**.
4. At the bottom of the Profile Details window, Click **Apply**.
 5. Click the new virtual AP name in the Profiles list or the Profile Details to display configuration parameters.
 6. Under Profile Details, do the following:
 - a. Make sure Virtual AP enable is selected.
 - b. From the **VLAN** drop-down menu, select the VLAN ID to use for the virtual AP profile.
 - c. From the **Forward mode** drop-down menu, select **bridge**.
 - d. From the **Remote-AP Operation** drop-down menu, select **always**, **backup**, or **persistent**. The default is **standard**. Click **Apply**.

Configuring the Virtual AP Profile for Fallback Mode in the CLI

```
wlan ssid-profile <profile>
  essid <name>
  opmode <method>
  wpa-passphrase <string> (if necessary)

wlan virtual-ap <name>
  ssid-profile <profile>
  vlan <vlan>
  forward-mode bridge
  aaa-profile <name>
  rap-operation {always|backup|persistent}

ap-group <name>
  virtual-ap <name>
```

or

```
ap-name <name>
  virtual-ap <name>
```

Configuring the DHCP Server on the Remote AP

You can configure the internal DHCP server on the remote AP to provide an IP address for the “backup” SSID if the controller is unreachable. If configured, the remote AP DHCP server intercepts all DHCP requests and assigns an IP address from the configured DHCP pool.

To configure the remote AP DHCP server:

- Enter the VLAN ID for the remote AP DHCP VLAN in the AP system profile. This VLAN enables the DHCP server on the AP (also known as the remote AP DHCP server VLAN). If you enter the native VLAN ID, the DHCP server is not configured and is unavailable.
- Specify the DHCP IP address pool and netmask. By default, the AP assigns IP addresses from the DHCP pool 192.168.11.0/24, with an IP address range from 192.168.11.2 through 192.168.11.254. You can manually define the DHCP IP address pool and netmask based on your network design and IP address scheme.
- Specify the IP address of the DHCP server, DHCP router, and the DHCP DNS server. By default, the AP uses IP address 192.168.11.1 for the DHCP server, the DHCP router and the DHCP DNS server.
- Enter the amount of days the assigned IP address is valid (also known as the remote AP DHCP lease). By default, the lease does not expire, which means the IP address is always valid.
- Assign the VLAN ID for the remote AP DHCP VLAN to a virtual AP profile. When a client connects to that virtual AP profile, the AP assigns the IP address from the DHCP pool.



NOTE: The following is a high-level description of the steps required to configure the DHCP server on the remote AP. The steps assume you have already created the virtual AP profile, AAA profile, SSID profile, and other settings for your remote AP operation (for information about the backup configuration, see ["Configuring Fallback Mode" on page 524](#)).

Using the WebUI

1. Navigate to the **Configuration > Wireless > AP Configuration** page.
2. Select either the AP Group or AP Specific tab. Click **Edit** for the AP group or AP name.
3. Under Profiles, select **AP** to display the AP profiles.
4. Select the AP system profile you want to modify.
5. Under Profile Details:
 - a. At the **LMS IP** field, enter the LMS IP address.
 - b. At the **Master controller IP address** field, enter the master controller IP address.
 - c. At the **Remote-AP DHCP Server VLAN** field, enter the VLAN ID of the backup configuration virtual AP VLAN.
 - d. At the **Remote-AP DHCP Server ID** field, enter the IP address for the DHCP server.
 - e. At the **Remote-AP DHCP Default Router** field, enter the IP address for the default DHCP router.
 - f. At the **Remote-AP DHCP DNS Server** list, enter an IP address in the field to right and click **Add**. You can add multiple IP addresses the same way. To delete an IP address, select an IP address from the list and click **Delete**.
 - g. Specify the DHCP IP address pool. This configures the pool of IP addresses from which the remote AP uses to assign IP addresses.
 - At the **Remote-AP DHCP Pool Start** field, enter the first IP address of the pool.
 - At the **Remote-AP-DHCP Pool End** field, enter the last IP address of the pool.
 - At the **Remote-AP-DHCP Pool Netmask** field, enter the netmask.
 - h. At the **Remote-AP DHCP Lease Time** field, specify the amount of time the IP address is valid.
6. Click **Apply**.
7. Under Profiles, select **Wireless LAN**, then **Virtual AP**, then the virtual AP profile you want to configure.
8. Under Profile Details, at the VLAN drop-list, select the VLAN ID of the remote AP DHCP VLAN, click the left arrow to move the VLAN ID to the VLAN field, and click **Apply**.

Using CLI

```
ap system-profile <name>
  lms-ip <ipaddr>
  master-ip <ipaddr>
  rap-dhcp-default-router <ipaddr>
  rap-dhcp-dns-server <ipaddr>
  rap-dhcp-lease <days>
  rap-dhcp-pool-end <ipaddr>
  rap-dhcp-pool-netmask <netmask>
  rap-dhcp-pool-start <ipaddr>
  rap-dhcp-server-id <ipaddr>
  rap-dhcp-server-vlan <vlan>

wlan virtual-ap <name>
  ssid-profile <profile>
  vlan <vlan>
  forward-mode bridge
```

```
aaa-profile <name>
rap-operation {always|backup|persistent}

ap-group <name>
ap-system-profile <name>
virtual-ap <name>
```

or

```
ap-name <name>
ap-system-profile <name>
virtual-ap <name>
```

Configuring Advanced Backup Options

You can also use the backup configuration (fallback mode) to allow the remote AP to pass through a captive portal, such as network access in a hotel, airport, or other public network, to access the corporate network. For this scenario:

- Define a session ACL for the bridge SSID to source NAT all user traffic, except DHCP. For example, use **any any svc-dhcp permit** followed by **any any any route src-nat**. Apply the session ACL to a remote AP user role.
- Configure the AAA profile. Make sure the initial role contains the session ACL previously configured. The AAA profile defines the authentication method and the default user role.



NOTE: 802.1x and PSK authentication is supported when configuring bridge or split tunnel mode.

- Configure the virtual AP profile for the backup configuration.
 - Set the remote AP operation to “always” or “backup.”
 - Create and apply the applicable SSID profile.
 - Configure a bridge SSID for the backup configuration. In the virtual AP profile, specify forward mode as “bridge.”

For more information about the backup configuration, see ["Configuring Fallback Mode" on page 524](#).

- Enter the remote AP DHCP server parameters in the AP system profile. For more information about the parameters, see ["Configuring the DHCP Server on the Remote AP " on page 526](#).

If you use a local DHCP server to obtain IP addresses, you must define one additional ACL to permit traffic between clients without source NATing the traffic. Using the previously configured ACL, add **user alias internal-network any permit** before **any any any route src-nat**.

- Connect the remote AP to the available public network (for example, a hotel or airport network).

The remote AP advertises the backup SSID so the wireless client can connect and obtain an IP address from the available DHCP server.



NOTE: The client can obtain an IP address from the public network, for example a hotel or airport, or from the DHCP server on the remote AP.

After obtaining an IP address, the wireless client can connect and access the corporate network and bring up the configured corporate SSIDs.

The following is a high-level description of what is needed to configure the remote AP to pass through a captive portal and access the corporate controller. This information assumes you are familiar with configuring session ACLs, AAA profiles, virtual APs, and AP system profiles and highlights the modified parameters.

Configuring the Session ACL in the WebUI

1. Navigate to the **Configuration > Security > Access Control > Policies** page.

2. Click **Add** to create a new policy.
3. Enter the policy name in the **Policy Name** field.
4. From the **Policy Type** drop-down list, select **IPv4 Session**.
5. To create the first rule:
 - a. Under **Rules**, click **Add**.
 - b. Under **Source**, select **any**.
 - c. Under **Destination**, select **any**.
 - d. Under **Service**, select **service**. In the service drop-down list, select **svc-dhcp**.
 - e. Under **Action**, select **permit**.
 - f. Click **Add**.
6. To create the next rule:
 - a. Under **Rules**, click **Add**.
 - b. Under **Source**, select **any**.
 - c. Under **Destination**, select **any**.
 - d. Under **Service**, select **any**.
 - e. Under **Action**, select **route**, and select the **src-nat** checkbox.
 - f. Click **Add**.
7. Click **Apply**.

 NOTE: If you use a local DHCP server to obtain IP addresses, you must define one additional ACL to permit traffic between clients without source NATing the traffic. Add `user alias internal-network any permit` before `any any any route src-nat`.

8. Click the **User Roles** tab.
 - a. Click **Add**.
 - b. Enter the Role Name.
 - c. Click **Add** under **Firewall Policies**.
 - d. In the **Choose from Configured Policies** menu, select the policy you just created.
 - e. Click **Done**.

Configuring the AAA Profile in the WebUI

1. Navigate to the **Security > Authentication > AAA Profiles** page. From the AAA Profiles Summary list, click **Add**.
2. Enter the AAA profile name, then click **Add**.
3. Select the AAA profile that you just created:
 - a. For Initial role, select the user role you just created.
 - b. For 802.1X Authentication Default Role, select the appropriate role for your remote AP configuration, then click **Apply**.
 - c. Under the AAA profile that you created, locate 802.1x Authentication Server Group, and select the authentication server group to use for your remote AP configuration, then click **Apply**.

 NOTE: If you need to create an 802.1x authentication server group, select **new** from the **802.1X Authentication Server Group** drop-down list, and enter the appropriate parameters.

- d. Under the AAA profile that you created, locate 802.1X Authentication Profile, and select the profile to use for your remote AP configuration, then click **Apply**.

Defining the Backup Configuration in the WebUI

1. Navigate to the **Configuration > Wireless > AP Configuration** page. Select either the AP Group or AP Specific tab. Click **Edit** for the AP group or AP name.
2. Under Profiles, select **Wireless LAN**, then **Virtual AP**.
3. To create a new virtual AP profile in the WebUI, select **New** from the **Add a profile** drop-down menu. Enter the name for the virtual AP profile, and click **Add**.



NOTE: Whenever you create a new virtual AP profile in the WebUI, the profile automatically contains the “default” SSID profile with the default ESSID. You must configure a new ESSID and SSID profile for the virtual AP profile before you apply the profile.

- a. In the Profile Details entry for the new virtual AP profile, go to the **AAA Profile** drop-down list and select the previously configured AAA profile. The AAA Profile pop-up window appears.
 - b. To set the AAA profile and close the pop-up window, Click **Apply**.
 - c. In the Profile Details entry for the new virtual AP profile, select **NEW** from the **SSID Profile** drop-down menu. The SSID Profile pop-up window displays to allow you to configure the SSID profile.
 - d. Enter the name for the SSID profile.
 - e. Under Network, enter a name in the Network Name (SSID) field.
 - f. Under Security, select the network authentication and encryption methods.
 - g. To set the SSID profile and close the pop-up window, click **Apply**.
4. At the bottom of the Profile Details window, Click **Apply**.
 5. Click the new virtual AP name in the Profiles list or the Profile Details to display configuration parameters.
 6. Under Profile Details, do the following:
 - a. Make sure Virtual AP enable is selected.
 - b. From the **VLAN** drop-down menu, select the VLAN ID to use for the Virtual AP profile.
 - c. From the **Forward mode** drop-down menu, select **bridge**.
 - d. From the **Remote-AP Operation** drop-down menu, select **always** or **backup**.
 - e. Click **Apply**.
 7. Under Profiles, select **AP**, then **AP system profile**.
 8. Under Profile Details, do the following:
 - a. Select the AP system profile to edit.
 - b. At the **LMS IP** field, enter the LMS IP address.
 - c. At the **Master controller IP address** field, enter the master controller IP address.
 - d. Configure the **Remote-AP DHCP Server** fields.
 - e. Click **Apply**.

Configuring the Session ACL in the CLI

```
ip access-list session <policy>
  any any svc-dhcp permit
  any any any route src-nat
```

If you use a local DHCP server to obtain IP addresses, you must define one additional ACL to permit traffic between clients without source NATing the traffic. Add **user alias internal-network any permit** before **any any route src-nat**.

```
user-role <role>
  session-acl <policy>
```

Using the CLI to configure the AAA profile

```
aaa profile <name>
  initial-role <role>
```

You can define other parameters as needed.

Defining the Backup Configuration in the CLI

```
wlan ssid-profile <profile>
  essid <name>
  opmode <method>
  wpa-passphrase <string> (if necessary)
```

```
wlan virtual-ap <name>
  ssid-profile <profile>
  vlan <vlan>
  forward-mode bridge
  aaa-profile <name>
  rap-operation {always|backup}
```

```
ap system-profile <name>
  lms-ip <ipaddr>
  master-ip <ipaddr>
  rap-dhcp-default-router <ipaddr>
  rap-dhcp-dns-server <ipaddr>
  rap-dhcp-lease <days>
  rap-dhcp-pool-end <ipaddr>
  rap-dhcp-pool-netmask <netmask>
  rap-dhcp-pool-start <ipaddr>
  rap-dhcp-server-id <ipaddr>
  rap-dhcp-server-vlan <vlan>
```

```
ap-group <name>
  virtual-ap <name>
  ap-system-profile <name>
```

or

```
ap-name <name>
  virtual-ap <name>
  ap-system-profile <name>
```

Specifying the DNS Controller Setting

In addition to specifying IP addresses for Dell controllers, you can also specify the master DNS name for the controller when provisioning the remote AP. The name must be resolved to an IP address when attempting to setup the IPsec tunnel. For information on how to configure a host name entry on the DNS server, refer to the vendor documentation for your server. Dell recommends using a maximum of 8 IP addresses to resolve a controller name.

If the remote AP gets multiple IP addresses responding to a host name lookup, the remote AP can use one of them to establish a connection to the controller. For more detailed information, see the next section "[Backup Controller List](#) " on page 532.

Specifying the name also lets you move or change remote AP concentrators without reprovisioning your APs. For example, in a DNS load-balancing model, the host name resolves to a different IP address depending on the location of the user. This allows the remote AP to contact the controller to which it is geographically closest.

The DNS setting is part of provisioning the AP. The easiest way to provision an AP is to use the Provisioning page in the WebUI. These instructions assume you are only modifying the controller information in the Master Discovery section of the Provision page.



NOTE: Reprovisioning the AP causes it to automatically reboot.

In the WebUI

1. Navigate to the **Configuration > Wireless > AP Installation > Provisioning** page. Select the remote AP and click **Provision**.
2. Under **Master Discovery** enter the master DNS name of the controller.
3. Click **Apply and Reboot**.

For more information, see "[Provision the AP](#)" on page 516.

Backup Controller List

Using DNS, the remote AP receives multiple IP addresses in response to a host name lookup. Known as the backup controller list, remote APs go through this list to associate with a controller. If the primary controller is unavailable or does not respond, the remote AP continues through the list until it finds an available controller. This provides redundancy and failover protection.

The remote AP loses the IP addresses information that is received through DNS when it terminates and receives the system profile configuration from the controller. If the remote AP loses connectivity on the IPsec tunnel to the controller, the RAP fails over from the primary controller to the backup controller. For this scenario, add the IP address of the backup controller in the backup LMS and the IP address of the primary controller in the LMS field of the ap-system profile. Network connectivity is lost during this time. As described in the section "[Configuring Remote AP Failback](#)" on page 533, you can also configure a remote AP to revert back to the primary controller when it becomes available. To complete this scenario, you must also configure the LMS IP address and the backup LMS IP address.

For example, assume you have two data centers, data center 1 and data center 2, and each data center has one master controller in the DMZ. You can provision the remote APs to use the controller in data center 1 as the primary controller, and the controller in data center 2 as the backup controller. If the remote AP loses connectivity to the primary, it will attempt to establish connectivity to the backup. You define the LMS parameters in the AP system profile.

Figure 171: Sample Backup Controller Scenario

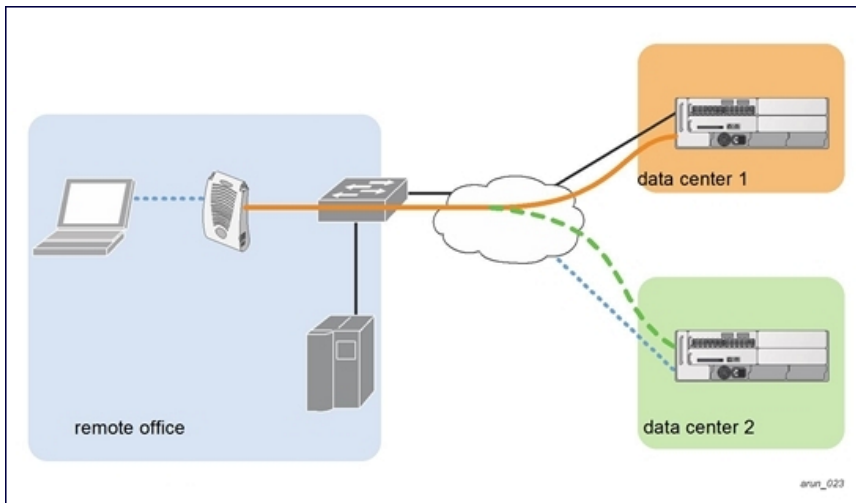

Configuring the LMS and backup LMS IP addresses in the WebUI

1. Navigate to the **Configuration > Wireless > AP Configuration** page.
2. Select either the **AP Group** or **AP Specific** tab. Click **Edit** for the AP group or AP name.
3. Under **Profiles**, select **AP** to display the AP profiles.
4. Select the AP system profile you want to modify.
5. Under **Profile Details**:
 - a. At the **LMS IP** field, enter the primary controller IP address.
 - b. At the **Backup LMS IP** field, enter the backup controller IP address.
6. Click **Apply**.

Configuring the LMS and backup LMS IP addresses in the CLI

```
ap system-profile <profile>
  lms-ip <ipaddr>
  bkup-lms-ip <ipaddr>

ap-group <group>
  ap-system-profile <profile>

ap-name <name>
  ap-system-profile <profile>
```

Configuring Remote AP Failback

In conjunction with the backup controller list, you can configure remote APs to revert back (failback) to the primary controller if it becomes available. If you do not explicitly configure this behavior, the remote AP will keep its connection with the backup controller until the remote AP, controller, or both have rebooted or some type of network failure occurs. If any of these events occur, the remote AP will go through the backup controller list and attempt to connect with the primary controller.

In the WebUI

1. Navigate to the **Configuration > Wireless > AP Configuration** page.
2. Select either the **AP Group** or **AP Specific** tab. Click **Edit** for the AP group or AP name.
3. Under **Profiles**, select **AP** to display the AP profiles.

4. Select the AP system profile you want to modify.
5. Under Profile Details:
 - a. Click (select) **LMS Preemption**. This is disabled by default.
 - b. At the **LMS Hold-down period** field, enter the amount of time the remote AP must wait before moving back to the primary controller.
6. Click **Apply**.

In the CLI

```
ap system-profile <profile>
  lms-preemption
  lms-hold-down period <seconds>
```

Enabling RAP Local Network Access

You can enable local network access between the clients (from same or different subnets and VLANs) connected to a RAP through wired or wireless interfaces in split-tunnel/bridge forwarding modes. This allows the clients to effectively communicate with each other without routing the traffic via the controller. You can use CLI or the WebUI to enable the local network access.

In the WebUI

1. Navigate to the **Configuration > Wireless > AP Configuration** page.
2. Select the AP Group tab. Click **Edit** for the AP group or AP name.
3. Under Profiles, expand the **AP** menu, then select **AP system profile**.
4. To enable remote network access, select the **Remote-AP Local Network Access** check box.

Figure 172: Enable Remote AP Local Network Access

Session ACL	ap-uplink-ad	Corporate DNS Domain	<input type="checkbox"/> Delete <input type="text"/> Add
Maintenance Mode	<input type="checkbox"/>	WISPr Location-ID ISO Country Code	<input type="text"/>
WISPr Location-ID E.164 Country Code	<input type="text"/>	WISPr Location-ID E.164 Area Code	<input type="text"/>
WISPr Location-ID SSID/Zone	<input type="text"/>	WISPr Operator Name	<input type="text"/>
WISPr Location Name	<input type="text"/>	Remote-AP Local Network Access	<input checked="" type="checkbox"/>

5. Click **Apply**.

In the CLI

- To enable, enter:

```
ap system-profile <ap-profile> rap-local-network-access
```
- To disable, enter:

```
ap system-profile <ap-profile> no rap-local-network-access
```

See the *Dell PowerConnect W-Series ArubaOS Command Line Reference Guide* for detailed information on the command options.

Configuring Remote AP Authorization Profiles

Remote AP configurations include an authorization profile that specifies which profile settings should be assigned to a remote AP that has been provisioned but not yet authenticated at the remote site. By default, these yet-

unauthorized APs are put into the temporary AP group **authorization-group** and assigned the predefined profile **NoAuthApGroup**. This configuration allows the user to connect to an unauthorized remote AP via a wired port then enter a corporate username and password. Once a valid user has authorized the AP and the remote AP will be marked as authorized on the network. The remote AP will then download the configuration assigned to that AP by its permanent AP group.

Adding or Editing a Remote AP Authorization Profile

To create a new authorization profile or edit an existing authorization profile via the WebUI:

1. Select **Configuration > All Profiles**. The **All Profile Management** window opens.
2. Select **AP** to expand the AP profile menu.
3. Select **AP Authorization Profile**. The **Profile Details** pane appears and displays the list of existing AP authorization profiles.
 - To edit an existing profile, select a profile from from the **Profile Details** pane.
 - To create a new authorization profile, enter a new profile name in the entry blank on the **Profile Details** pane, then click **Add**.
4. The **Profile Details** window will display the AP group currently defined for that authorization profile. To select a new AP group, click the drop-down list and select a different AP group name.
5. Click **Apply** to save your changes.

To create a new authorization profile or edit an existing authorization profile via the command-line interface, access the command-line interface in enable mode, and issue the following commands.

```
ap authorization-profile <profile>
  authorization-group <ap-group>
```

Working with Access Control Lists and Firewall Policies

Remote APs support the following access control lists (ACLs); unless otherwise noted, you apply these ACLS to user roles:

- Standard ACLs—Permit or deny traffic based on the source IP address of the packet.
- Ethertype ACLs—Filter traffic based on the Ethertype field in the frame header.
- MAC ACLs—Filter traffic on a specific source MAC address or range of MAC addresses.
- Firewall policies (session ACLs)—Identifies specific characteristics about a data packet passing through the Dell controller and takes some action based on that identification. You apply these ACLs to user roles or uplink ports.



NOTE: To configure firewall policies, you must install the PEFNG license.

For more information about ACLs and firewall policies, see ["Configuring Fallback Mode" on page 524](#).

Understanding Split Tunneling

The split tunneling feature allows you to optimize traffic flow by directing only corporate traffic back to the controller, while local application traffic remains local. This ensures that local traffic does not incur the overhead of the round trip to the controller, which decreases traffic on the WAN link and minimizes latency for local application traffic. This is useful for sites that have local servers and printers. With split tunneling, a remote user associates with a single SSID, not multiple SSIDs, to access corporate resources (for example, a mail server) and local resources (for example, a local printer). The remote AP examines session ACLs to distinguish between corporate traffic destined for the controller and local traffic.

Figure 173: Sample Split Tunnel Environment

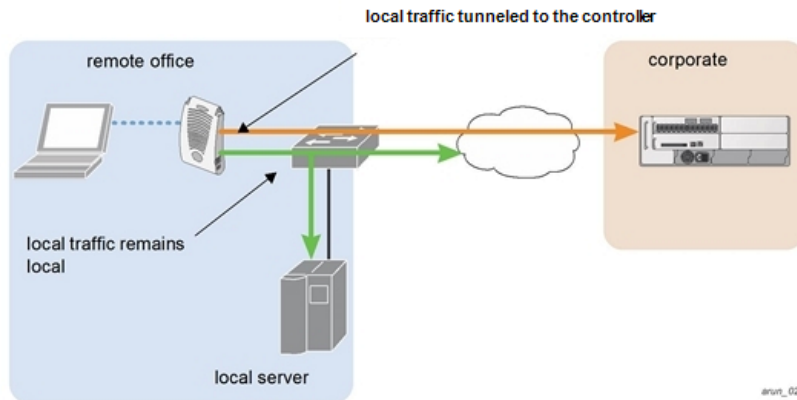

Figure 173 displays corporate traffic is GRE tunneled to the controller through a trusted tunnel and local traffic is source NATed and bridged on the wired interface based on the configured user role and session ACL.

Configuring Split Tunneling

The procedure to configure split tunneling requires the following steps. Each step is described in detail later in this chapter.



NOTE: The split tunneling feature requires the PEFNG license. If you do not have the PEFNG license on your controller, you must install it before you configure split tunneling. For details on installing licenses, see ["Software Licenses" on page 100](#).

1. Define a session ACL that forwards only corporate traffic to the controller.
 - a. Configure a netdestination for the corporate subnets.
 - b. Create rules to permit DHCP and corporate traffic to the corporate controller.
 - c. Apply the session ACL to a user role. For information about user roles and policies, see [Roles and Policies on page 296](#).
2. (Optional) Configure an ACL that restricts remote AP users from accessing the remote AP local debugging homepage.
3. Configure the remote AP's AAA profile.
 - a. Specify the authentication method (802.1x or PSK) and the default user role for authenticated users. The user role specified in the AAA profile must contain the session ACL defined in the previous step.
 - b. (Optional) Use the remote AP's AAA profile to enable RADIUS accounting.
4. Configure the virtual AP profile:
 - a. Specify which AP group or AP to which the virtual AP profile applies.
 - b. set the VLAN used for split tunneling. Only one VLAN can be configured for split tunneling; VLAN pooling is not allowed.
 - c. When specifying the use of a split tunnel configuration, use "split-tunnel" forward mode.
 - d. Create and apply the applicable SSID profile.



NOTE: When creating a new virtual AP profile in the WebUI, you can also configure the SSID at the same time. For information about AP profiles, see ["Understanding AP Configuration Profiles" on page 396](#).

5. (Optional) Create a list of network names resolved by corporate DNS servers.

Configuring the Session ACL Allowing Tunneling

First you need to configure a session ACL that “permits” corporate traffic to be forwarded (tunneled) to the controller, and that “routes”, or locally bridges, local traffic.

Using the WebUI

1. Navigate to the **Configuration > Security > Access Control > Policies** page.
2. Click **Add** to create a new policy.
3. Enter the policy name in the **Policy Name** field.
4. From the **Policy Type** drop-down list, select **Session**.
5. From the **IP Version** drop-down list, select **IPv4** or **IPv6**.
6. To create the first rule:

- a. Under **Rules**, click **Add**.
- b. Under **Source**, select **any**.
- c. Under **Destination**, select **any**.
- d. Under **Service**, select **service**. In the service drop-down list, select **svc-dhcp**.
- e. Under **Action**, select **permitforIPv4** or **capturefor IPv6**.
- f. Click **Add**.

7. To create the next rule:

- a. Under **Rules**, click **Add**.
- b. Under **Source**, select **any**.
- c. Under **Destination**, select **alias**.

The following steps define an alias representing the corporate network. Once defined, you can use the alias for other rules and policies. You can also create multiple destinations the same way.

8. Under the **alias** section, click **New**. Enter a name in the **Destination Name** field.
 - a. Click **Add**.
 - b. For **Rule Type**, select **Network**.
 - c. Enter the public IP address of the controller.
 - d. Enter the Network Mask/Range.
 - e. Click **Add** to add the network range.
 - f. Click **Apply**. The new alias appears in the **Destination** menu.

9. Under **Destination**, select the alias you just created.

10. Under **Service**, select **any**.

11. Under **Action**, select **permitfor IPv4** or **capturefor IPv6**.

12. Click **Add**.

13. To create the next rule:

- a. Under **Rules**, click **Add**.
- b. Under **Source**, select **user**.
- c. Under **Destination**, select **any**.
- d. Under **Service**, select **any**.
- e. Under **Action**, select **any** and check **src-nat**.
- f. Click **Add**.

14. Click **Apply**.

15. Click the **User Roles** tab.
 - a. Click **Add** to create and configure a new user role.
 - b. Enter the desired name for the role in the **Role Name** field.
 - c. Under Firewall Policies, click **Add**.
 - d. From the **Choose from Configured Policies** drop-down menu, select the policy you just configured.
 - e. Click **Done**.
16. Click **Apply**.

Using the CLI

```

ap system-profile <profile>
  lms-preemption
  lms-hold-down period <seconds>netdestination <policy>
  network <ipaddr> <netmask>
  network <ipaddr> <netmask>

ip access-list session <policy>
  any any svc-dhcp permit
  any alias <name> any permit
  user any any route src-nat

user-role <role>
  session-acl <policy>

```

When defining the alias, there are a number of other session ACLs that you can create to define the handling of local traffic, such as:

```

ip access-list session <policy>
  user alias <name> any redirect 0
  user alias <name> any route
  user alias <name> any route src-nat

```

Configuring an ACL to Restrict Local Debug Homepage Access

A user in split or bridge role using a remote AP (RAP) can log on to the local debug (LD) homepage and perform a reboot or reset operations. The LD homepage provides various information about the RAP and also has a button to reboot the RAP. You can now restrict a RAP user from resetting or rebooting a RAP by using the `localip` keyword in the in the user role ACL.



NOTE: You will require the PEFNG license to use this feature. See [Software Licenses on page 100](#) for more information on licensing requirements.

Any user associated to that role can be allowed or denied access to the LD homepage. You can use the `localip` keyword in the ACL rule to identify the local IP address on the RAP. The `localip` keyword identifies the set of all local IP addresses on the system to which the ACL is applied. The existing keywords `controller` and `mswitch` indicate only the primary IP address on the controller.



NOTE: This release of ArubaOS provides `localip` keyword support only for RAP and not for controller.

In the WebUI

1. Navigate to the **Configuration > Security > Access Control > Policies** page.
2. Click **Add** to create a new policy.
3. Enter the policy name in the **Policy Name** field.

4. From the **Policy Type** drop-down list, select **IPv4 Session**.
5. To create the first rule:
 - a. Under Rules, click **Add**.
 - b. Under Source, select **localip**.
 - c. Under Destination, select **any**.
 - d. Under Action, select **permit**.
 - e. Click **Apply**.

Figure 174: Enable Restricted Access to LD Homepage

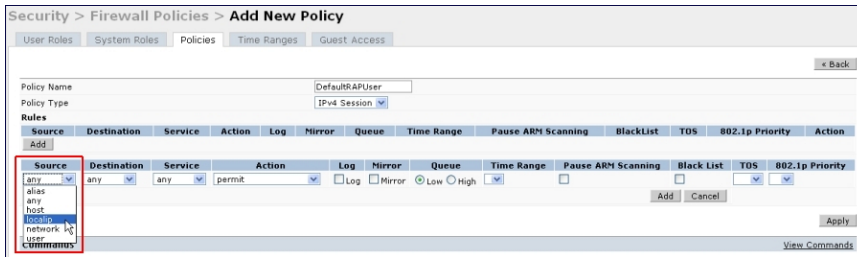

In the CLI

Use the `localip` keyword in the user role ACL.

By default, all users have an ACL entry of type `any any deny`. This rule restricts access to all users. When the ACL is configured for a user role, if a `user any permit` ACL rule is configured, add a `deny` ACL before that for `localip` for restricting the user from accessing the LD homepage.

Example:

```
ip access-list session logon-control
  user localip svc-http deny
  user any permit
```

Configuring the AAA Profile for Tunneling

After you configure the session ACL, you define the AAA profile used for split tunneling. When defining the AAA parameters, specify the previously configured user role that contains the session ACL used for split tunneling.

If you enable RADIUS accounting in the AAA profile, the controller sends a RADIUS accounting start record to the RADIUS server when a user associates with the remote AP, and sends a stop record when the user logs out or is deleted from the user database. If interim accounting is enabled, the controller sends updates at regular intervals. Each interim record includes cumulative user statistics, including received bytes and packets counters. For more information on RADIUS accounting, see ["RADIUS Accounting" on page 185](#)

In the WebUI

1. Navigate to the **Security > Authentication > AAA Profiles** page. From the AAA Profiles Summary list, click **Add**.
2. Enter the AAA profile name, then click **Add**.
3. Select the AAA profile that you just created.
 - a. For 802.1X Authentication Default Role, select the user role you previously configured for split tunneling, then click **Apply**.
 - b. Under the AAA profile that you created, locate 802.1x Authentication Server Group, and select the authentication server group to use, then click **Apply**.
4. (Optional) To enable RADIUS accounting:

- a. Select the AAA profile from the profile list to display the list of authentication and accounting profiles associated with the AAA profile.
 - b. Select the **Radius Accounting Server Group** profile associated with the AAA profile. Click the **RADIUS Accounting Server Group** drop-down list to select a RADIUS server group. (For more information on configuring a RADIUS server or server group, see "[Configuring a RADIUS Server](#)" on page 169.)
 - c. To enable RADIUS Interim Accounting, select the AAA profile name from the profile list, then click the **RADIUS Interim Accounting** checkbox. This option is disabled by default, allowing the controller to send only *start* and *stop* messages RADIUS accounting server.
5. Click **Apply**.

If you need to create an authentication server group, select **new** and enter the appropriate parameters.

In the CLI

```
aaa profile <name>
  authentication-dot1x <dot1x-profile>
  dot1x-default-role <role>
  dot1x-server-group <group>
  radius-accounting <group>
  radius-interim-accounting
```

Configuring the Tunneling Virtual AP Profile

In the WebUI

1. Navigate to **Configuration > Wireless > AP Configuration** page. Select either the AP Group or AP Specific tab. Click **Edit** for the applicable AP group name or AP name.
2. Under Profiles, select **Wireless LAN**, then **Virtual AP**.
3. To create a new virtual AP profile in the WebUI, select **New** from the **Add a profile** drop-down menu. Enter the name for the virtual AP profile, and click **Add**.



NOTE: Whenever you create a new virtual AP profile in the WebUI, the profile automatically contains the "default" SSID profile with the default ESSID. You must configure a new ESSID and SSID profile for the virtual AP profile before you apply the profile.

- a. In the Profile Details entry, go to the AAA Profile drop-down list and select the previously configured AAA profile. The AAA Profile pop-up window appears.
 - b. To set the AAA profile and close the window, click **Apply**.
 - c. In the Profile Details entry for the new virtual AP profile, select **NEW** from the **SSID Profile** drop-down menu. A pop-up window displays to allow you to configure the SSID profile.
 - d. Enter the name for the SSID profile.
 - e. Under Network, enter a name in the Network Name (SSID) field.
 - f. Under Security, select the network authentication and encryption methods.
 - g. To set the SSID profile and close the window, click **Apply**.
4. Click **Apply** at the bottom of the Profile Details window.
5. Click the new virtual AP name in the Profiles list or the Profile Details to display configuration parameters.
6. Under Profile Details:
- a. Make sure Virtual AP enable is selected.
 - b. From the **VLAN** drop-down menu, select the VLAN ID for the VLAN to be used for split tunneling.
 - c. From the **Forward mode** drop-down menu, select **split-tunnel**.
 - d. Click **Apply**.

In the CLI

```
wlan ssid-profile <profile>  
    essid <name>  
    opmode <method>
```

```
wlan virtual-ap <profile>  
    ssid-profile <name>  
    forward-mode split-tunnel  
    vlan <vlan id>  
    aaa-profile <profile>
```

```
ap-group <name>  
    virtual-ap <profile>
```

or

```
ap-name <name>  
    virtual-ap <profile>
```

Defining Corporate DNS Servers

Clients send DNS requests to the corporate DNS server address that it learned from DHCP. If configured for split tunneling, corporate domains and traffic destined for corporate use the corporate DNS server. For non-corporate domains and local traffic, other DNS servers can be used.

In the WebUI

1. Navigate to **Configuration > Wireless > AP Configuration** page.
2. Select either the AP Group or AP Specific tab. Click **Edit** for the AP group or AP name.
3. Under Profiles, select **AP**, then **AP system profile**.
4. Under Profile Details:
 - a. Enter the corporate DNS servers.
 - b. Click **Add**.

The DNS name appears in Corporate DNS Domain list. You can add multiple names the same way.

5. Click **Apply**.

In the CLI

```
ap system-profile <profile>  
    dns-domain <domain name>
```

Provisioning Wi-Fi Multimedia

Wi-Fi Multimedia (WMM) is a Wi-Fi Alliance specification based on the IEEE 802.11e wireless Quality of Service (QoS) standard. WMM works with 802.11a, b, g, and n physical layer standards. The IEEE 802.11e standard also defines the mapping between WMM access categories (ACs) and Differentiated Services Codepoint (DSCP) tags. Remote APs support WMM.

WMM supports four ACs: voice, video, best effort, and background. You apply and configure WMM in the SSID profile.

When planning your configuration, make sure that immediate switches or routers do not have conflicting 802.1p or DSCP configurations/mappings. If this occurs, your traffic may not be prioritized correctly.

For more detailed information about WMM and the applicable configuration commands, see [Voice and Video on page 682](#).

Reserving Uplink Bandwidth

You can reserve and prioritize uplink bandwidth traffic to provide higher QoS for specific applications, traffic or ports. This is done by applying bandwidth reservation on existing session ACLs. Typically, the bandwidth reservation is applied for uplink voice traffic.

The following must be noted before you configure bandwidth reservation:

- You must know the total bandwidth available.
- The bandwidth reservation are applicable only on session ACLs.
- Bandwidth reservation on voice traffic ACLs receives higher priority over other reserved traffic.
- You can configure up to three unique priority for bandwidth reservation.
- The bandwidth reservation must be specified in absolute value (kbps).
- Priorities for bandwidth reservation are optional and bandwidth reservations without priorities will be treated equal.

Understanding Bandwidth Reservation for Uplink Voice Traffic

The voice ACLs are applicable on the voice signalling traffic used to establish voice call through a firewall. When a voice ACL is executed, a dynamic session is introduced to allow voice traffic through the firewall. This prevents the re-use of voice ACLs for bandwidth reservation. However, you can create bandwidth reservation rules that can be applied on voice signalling traffic and also on ports used for voice data traffic. This mechanism filters traffic as per the security requirements.

Configuring Bandwidth Reservation

You can configure bandwidth reservation ACLs using CLI or the WebUI.

In the WebUI

To configure bandwidth reservation

1. Navigate to **Configuration > Advanced Services > All Profiles**
2. Under *Profiles*, navigate to **AP > AP System Profile**. You can create a new AP system profile to configure bandwidth reservation or edit an existing AP system profile. Under the *Profile Details* page, specify bandwidth reservation values.

Figure 175: Uplink Bandwidth Reservation

Remote-AP uplink total bandwidth	<input type="text" value="1024"/> kbps	RAP bw reservation 1	aclname <input type="text" value="voice"/> bwvalue <input type="text" value="128"/> prio <input type="text" value="1"/>
RAP bw reservation 2	aclname <input type="text"/> bwvalue <input type="text"/> prio <input type="text"/>	RAP bw reservation 3	aclname <input type="text"/> bwvalue <input type="text"/> prio <input type="text"/>
Heartbeat DSCP	<input type="text" value="0"/>	Session ACL	<input type="text" value="ap-uplink-acl"/>

In the CLI

```
(host) (config)#ap system-profile remotebw
(host) (AP system profile "remotebw") #rap-bw-total 1024
(host) (AP system profile "remotebw") #rap-bw-resv-1 acl voice 128 priority 1
```

To view bandwidth reservations:

```
(host) #show datapath rap-bw-resv ap-name remote-ap-1
```

RAP Uplink BW reservation statistics

Pos:	AcL	Resv	Prio	XmitPkts	XmitByte	Marked	Enqueued	Onqueue	Drops	TokenFin
1	:	11	200	0	0	3	0	0	0	0
2	:	0	0	0	0	0	0	0	0	0
3	:	0	0	0	0	0	0	0	0	0
4	:	0	0	1524	370962	0	1524	0	0	0

Provisioning 4G USB Modems on Remote Access Points

ArubaOS provides support for 4G network by allowing you to provision 4G USB modems on the RAP. You can also provision the RAP to support both 4G and 3G USB modems. This enables the RAP to choose the available network in an area automatically. 4G takes precedence over 3G when the RAP tries to auto-select the network. You can also configure the RAP to work exclusively on a 3G or 4G network. It is recommended that you provision the USB modems for the RAP based on your network requirements.

4G USB Modem Provisioning Best Practices and Exceptions

- The RAP does not support dynamic plug-and-play for the 4G modems. So, you must provision a RAP with the 4G USB parameters on the controller manually based on its type and family(4G-WiMAX/4G-LTE).
- When a RAP connects to a 4G network, it will be displayed as Remote AP (R) and Cellular (C) on the controller.
- For 3G/4G network switch support, it is recommended to use the UML290 modem with the firmware version L0290VWB522F.242 or later. Using a lower version of the firmware auto-selects the network mode based on the network availability. Whereas, the latest version allows the RAP to lock the modem in a particular network mode (say, 3G only).



NOTE: The 4G-WiMAX family of modems do not support the 3G-4G network switch-over functionality.

Provisioning RAP for USB Modems

To enable 3G/4G network support, you must provision the RAP with the USB parameters on the controller. You can use the WebUI or CLI to provision the USB parameters.

In the WebUI

1. Navigate to **Configuration > Wireless > AP Installation** page.
2. Select the **Provisioning** tab.
3. Select an AP and click **Provision**.
4. Under **USB Settings**, select the **USB Parameters** check box.
5. To enable 4G network support, select a driver option in the **4G Device Type** drop-down menu based on your device type:
 - beceem-wimax
 - ether-lte
 - pantech-lte

To enable 4G-exclusive network support, select a driver option in the **4G Device Type** drop-down menu and select *none* in the **Device Type** drop-down menu.

6. To enable 3G network support, select a driver option from the **Device Type** drop-down menu:

- acm
- airprime
- hso
- option
- pantech-3g
- sierra-evdo
- sierra-gsm

To enable 3G-exclusive network support, select a driver option in the **Device Type** drop-down menu and select *none* in the **4G Device Type** drop-down menu.



NOTE: To enable 3G/4G network switch support, select a driver option in both **Device Type** and **4G Device Type** drop-down menus.

7. Click **Apply and Reboot** to reboot the RAP with the new configuration.

In the CLI

To enable 4G-exclusive network support on the RAP, execute the following commands:

```
(host) (config) #ap provisioning-profile <profile-name>
(host) (Provisioning profile "<profile-name>") #4g-usb-type <USB modem type>
(host) (Provisioning profile "<profile-name>") #usb-type none
```

To enable 3G-exclusive network support on the RAP, execute the following commands:

```
(host) (config) #ap provisioning-profile <profile-name>
(host) (Provisioning profile "<profile-name>") #usb-type <USB modem type>
(host) (Provisioning profile "<profile-name>") #4g-usb-type none
```

To enable 3G/4G network switch support, execute the following commands:

```
(host) (config) #ap provisioning-profile <profile-name>
(host) (Provisioning profile "<profile-name>") #4g-usb-type <USB modem type>
(host) (Provisioning profile "<profile-name>") #usb-type <USB modem type>
```

RAP 3G/4G Backhaul Link Quality Monitoring

The RAP is enhanced to support link monitoring on 2G, 3G, and 4G modems to provide information about the state of USB modem and cellular network.

The USB modem has the following four states:

- **Active** - The USB modem is used as the primary path for connecting VPN to the controller
- **Standby or Backup** - The network is available but the USB modem is not used for connecting VPN to the controller
- **Error** - The USB modem is available but the modem is faulty
- **Not Plugged** - The USB modem is unavailable

To view the USB modem details on the RAP, execute the following command:

```
(host) #show ap debug usb ap-name <ap-name>
```

The following is a sample output that shows the USB information provisioned on the RAP:

```
USB Information
```

Parameter	Value
Manufacturer	Pantech,
Product	PANTECH
Serial Number	
Driver	ptuml_cdc_ether
Vendor ID	106c
Product ID	3718
USB Modem State	Active
USB Uplink RSSI(in dBm)	-73
Supported Network Services	CDMA GSM LTE
Firmware Version	L0290VWB522F.242
ESN Number	990000472325325
Current Network Service	4G-LTE

Configuring W-IAP3WN Access Points

This release of ArubaOS introduces support for W-IAP3WN and W-IAP3WNP access points (APs). The Dell W-IAP3WN and W-IAP3WNP are single-radio, single-band wireless APs that support the IEEE 802.11n standard for high-performance WLAN. These APs use MIMO (Multiple-in, Multiple-out) technology and other high-throughput mode techniques to deliver high-performance, 802.11n 2.4 GHz functionality while simultaneously supporting existing 802.11 b/g wireless services.

See the *Dell PowerConnect W-Series W-IAP3WN Installation Guide* for more information.



NOTE: These access points require Dell Instant 3.0 or later to operate as an Instant AP or ArubaOS 6.1.4.0 or later to operate as a Remote AP.

The Power Sourcing Equipment (PSE) functionality is available only for W-IAP3WNP APs, as the PoE itself provides the PSE functionality for W-IAP3WN APs. You can use the WebUI or CLI to enable or disable the PSE functionality on the W-IAP3WNP APs.

Using the WebUI

1. Navigate to the **Configuration > Advanced Services > All Profiles** page.
2. Select the **AP** tab and then select the **AP Ethernet Link profile** tab.
3. Select the **default** tab .
4. Select the **Power over Ethernet** checkbox.
5. Click **Apply**.Support for W-IAP3WN and W-IAP3WNP access points (APs)

Using the CLI

- To enable, enter:

```
(host) (config) #ap enet-link-profile <name>
  poe
```
- To disable, enter:

```
(host) (config) #ap enet-link-profile <name>
  no poe
```

Use the following command to view the PoE port status on an AP:

```
(host) #show ap enet-link-profile default
  AP Ethernet Link profile "default"
  -----
  Parameter Value
  -----
```

Speed auto
Duplex auto
Power over Ethernet Disabled

Converting an IAP to RAP or CAP

For IAP to RAP or CAP conversion, the Virtual Controller sends the convert command to all the other IAPs. The Virtual Controller along with the other slave IAPs then setup a VPN tunnel to the remote controller, and download the firmware by FTP. The Virtual Controller uses IPsec to communicate to the controller over the internet.



NOTE: A mesh point cannot be converted to RAP because mesh does not support VPN connection.

An IAP can be converted to a Campus AP and Remote AP only if the controller is running ArubaOS 6.1.4 or later. The following table describes the supported IAP platforms and minimal AOS version for IAP to CAP/RAP conversion.

Converting IAP to RAP

To convert an IAP to RAP, follow the instructions below:

1. Navigate to the **Maintenance** tab in the top right corner of the Instant UI.
2. Click the **Convert** tab.
3. Select **Remote APs managed by a Mobility Controller** from the drop-down list.
4. Enter the hostname (fully qualified domain name) or the IP address of the controller in the **Hostname or IP Address of Mobility Controller** text box. This information is provided by your network administrator.



NOTE: Ensure the Mobility Controller IP Address is reachable by the IAPs.

5. Click **Convert Now** to complete the conversion.
6. The IAP reboots and begins operating in RAP mode.
7. After conversion, the IAP is managed by the Dell controller which has been specified in the Instant UI.



NOTE: In order for the RAP conversion to work, ensure that you configure the Instant AP in the RAP white-list and enable the FTP service on the controller.



NOTE: If the VPN setup fails and an error message pops up, please click OK, copy the error logs and share them with your Dell support engineer.

Converting an IAP to CAP

To convert an IAP to Campus AP, do the following:

1. Navigate to the **Maintenance** tab in the top right corner of the Instant UI.
2. Click the **Convert** tab.
3. Select **Campus APs managed by a Mobility Controller** from the drop-down list.
4. Enter the hostname (fully qualified domain name) or the IP address of the controller in the **Hostname or IP Address of Mobility Controller** text box. This is provided by your network administrator.



NOTE: Ensure the Mobility Controller IP Address is reachable by the IAPs.

5. Click **Convert Now** to complete the conversion.

Enabling Bandwidth Contract Support for RAPs

This release of ArubaOS provides Bandwidth Contract support on remote APs. This is achieved by extending the Bandwidth Contract support on split-tunnel and bridge modes.

You can apply Bandwidth Contract for a RAP on a per-user or per-role basis. By default, Bandwidth Contract is applied on a per-role basis. This implies that all the users belonging to the same role will share the bandwidth pool. When Bandwidth Contract configured on the controller is attached to a user-role, it automatically gets pushed to the RAPs terminating on it.

The following show commands have been enhanced in this release to retrieve the Bandwidth Contract information from the RAP:

```
show datapath user ap-name <ap-name>
show datapath bwm ap-name <ap-name>
```



NOTE: Bandwidth Contract is not supported on legacy APs such as AP6x, AP70 and RAP-2 due to memory constrains.

Configuring Bandwidth Contracts for RAP

You can configure bandwidth contracts for RAP on a per-role or per-user basis. The following examples illustrate how to configure, apply, and verify the Bandwidth Contracts on the RAPs.

Defining Bandwidth Contracts

Use the following command to define a 256 Kbps contract:

```
(host) (config) #aaa bandwidth-contract 256k kbits 256
```

Use the following command to define a 512 Kbps contract

```
(host) (config) #aaa bandwidth-contract 512k kbits 512
```

Applying Contracts

You can apply the contract on a per-role or per-user basis.

Applying Contracts Per-Role

Use the following commands to apply the contracts on a per-role basis for upstream and downstream:

For upstream contract of 512 Kbps:

```
(host) (config) #user-role authenticated bw-contract 512k upstream
```

For downstream contract of 256 Kbps:

```
(host) (config) #user-role authenticated bw-contract 256k downstream
```

Applying Contracts Per-User

Use the following commands to apply the contracts on a per-user basis for upstream and downstream:

For upstream contract of 512 Kbps:

```
(host) (config) #user-role authenticated bw-contract 512k per-user upstream
```

For downstream contract of 256 Kbps:

```
(host) (config) #user-role authenticated bw-contract 256k per-user downstream
```

Verifying Contracts on AP

The following example displays the bandwidth contracts on AP for per-role configuration:

```
(host) #show datapath bwm ap-name rap5-2

Datapath Bandwidth Management Table Entries
-----
Contract Types :
0 - CP Dos 1 - Configured contracts 2 - Internal contracts
-----
Flags: Q - No drop, P - No shape(Only Policed),
T - Auto tuned
-----
Cont          Avail  Queued/Pkts
Type Id      Bits/sec Policed  Bytes  Bytes  Flags
-----
1   1         512000    0  16000   0/0   P
1   2         256000    0   8000   0/0   P
```

The following example displays the bandwidth contracts on AP for per-user configuration (contract IDs 3 and 4 are per-user contracts):

```
(host) #show datapath bwm ap-name rap5-2

Datapath Bandwidth Management Table Entries
-----
Contract Types :
0 - CP Dos 1 - Configured contracts 2 - Internal contracts
-----
Flags: Q - No drop, P - No shape(Only Policed),
T - Auto tuned
-----
Cont          Avail  Queued/Pkts
Type Id      Bits/sec Policed  Bytes  Bytes  Flags
-----
1   1         512000   300  16000   0/0   P
1   2         256000   277   8000   0/0   P
1   3         512000    0  16000   0/0   P
1   4         256000    0   8000   0/0   P
```

Verifying Contracts Applied to Users

You can verify if the contracts are applied to the user after the user connects to the AP using CLI.

The following is a sample output for a per-role configuration:

```
(host) #show datapath user ap-name rap5-2

Datapath User Table Entries
-----
Flags: P - Permanent, W - WEP, T- TKIP, A - AESCCM, G - AESGCM, V - ProxyArp to/for MN
(Visitor),
N - VPN, L - local, Y - Any IP user, R - Routed user, M - Media Capable,
S - Src NAT with VLAN IP, E - L2 Enforced, F - IPIP Force Delete, O - VOIP user
FM(Forward Mode): S - Split, B - Bridge, N - N/A
IP          MAC          ACLs      Contract  Location Age  Sessions  Flags  Vlan  FM
-----
-   -
10.15.72.50 00:0B:86:61:12:AC 2703/0    0/0      0      0      16      1/65535 P
0   N
10.15.72.253 00:18:8B:A9:A8:DF 52/0      1/2      0      0      1      0/65535
1   S
```

```

192.168.11.1    00:0B:86:66:03:3F  2700/0    0/0    0        20024    0/65535    P
177    N
10.15.196.249  00:0B:86:66:03:3F  2700/0    0/0    0         3        1/65535    P
1      N

```

The following is a sample output for a per-user configuration:

```
(host) #show datapath user ap-name rap5-2
```

```
Datapath User Table Entries
```

```
-----
Flags: P - Permanent, W - WEP, T- TKIP, A - AESCCM, G - AESGCM, V - ProxyArp to/for MN
(Visitor),
```

```
N - VPN, L - local, Y - Any IP user, R - Routed user, M - Media Capable,
```

```
S - Src NAT with VLAN IP, E - L2 Enforced, F - IPIP Force Delete, O - VOIP user
```

```
FM(Forward Mode): S - Split, B - Bridge, N - N/A
```

IP	MAC	ACLs	Contract	Location	Age	Sessions	Flags	Vlan	FM
10.15.72.50	00:0B:86:61:12:AC		2703/0	0/0	0	11	0/65535	P	
0	N								
10.15.72.253	00:18:8B:A9:A8:DF		52/0	3/4	0	46	0/65535		
1	S								
192.168.11.1	00:0B:86:66:03:3F		2700/0	0/0	0	20883	0/65535	P	
177	N								
10.15.196.249	00:0B:86:66:03:3F		2700/0	0/0	0	15	1/65535	P	
1	N								

Verifying Bandwidth Contracts During Data Transfer

You can verify the Bandwidth Contracts that are in use during data transfer using CLI.

The following is a sample output for a per-role configuration:

```
(host) #show datapath session ap-name rap5-2 table 10.15.72.99
```

```
Datapath Session Table Entries
```

```
-----
Flags: F - fast age, S - src NAT, N - dest NAT
```

```
D - deny, R - redirect, Y - no syn
```

```
H - high prio, P - set prio, T - set ToS
```

```
C - client, M - mirror, V - VOIP
```

```
Q - Real-Time Quality analysis
```

```
I - Deep inspect, U - Locally destined
```

```
E - Media Deep Inspect, G - media signal
```

```
RAP Flags: 1 - Class 1, 2 - Class 2, 3 - Class 3
```

Source IP	Destination IP	Prot	SPort	DPort	Cntr	Prio	ToS	Age	Destination	TAge	Flags
10.15.72.253	10.15.72.99	6	5001	36092	1/1	0	0	0	dev12	6	
10.15.72.253	10.15.72.99	6	3488	5001	1/1	0	0	0	dev5	6	C
10.15.72.99	10.15.72.253	6	5001	3488	1/2	0	0	0	dev5	6	
10.15.72.99	10.15.72.253	6	36092	5001	1/2	0	0	0	dev12	6	C

The following is a sample output for a per-user configuration:

```
(host) #show datapath session ap-name rap5-2 table 10.15.72.99
```

```
Datapath Session Table Entries
```

```
-----
Flags: F - fast age, S - src NAT, N - dest NAT
```

```
D - deny, R - redirect, Y - no syn
```

```
H - high prio, P - set prio, T - set ToS
```

```
C - client, M - mirror, V - VOIP
```

```
Q - Real-Time Quality analysis
```

I - Deep inspect, U - Locally destined

E - Media Deep Inspect, G - media signal

RAP Flags: 1 - Class 1, 2 - Class 2, 3 - Class 3

Source IP	Destination IP	Prot	SPort	DPort	Cntr	Prio	ToS	Age	Destination	TAge	Flags
10.15.72.253	10.15.72.99	6	3489	5001	1/3	0	0	0	dev5	37	FC
10.15.72.99	10.15.72.253	6	5001	3489	1/4	0	0	0	dev5	37	F
10.15.72.99	10.15.72.253	6	36096	5001	1/4	0	0	0	dev12	37	C
10.15.72.253	10.15.72.99	6	5001	36096	1/3	0	0	0	dev12	37	

Chapter 31

Virtual Intranet Access

Virtual Intranet Access (VIA) is part of the Dell remote networks solution targeted for teleworkers and mobile users. VIA detects the users network environment (trusted and un-trusted) and automatically connects the user to their enterprise network. Trusted networks typically refers to a protected office network that allows users to directly access corporate intranet. Un-trusted networks are public Wi-Fi hotspots like airports, cafes, or home network. The VIA solution comes in two parts—VIA connection manager and the controller configuration.

- VIA connection manager—Teleworkers and mobile users can easily install a light weight application on their Microsoft Windows or Apple MacBook computers to connect to their enterprise network from remote locations (see "[Understanding VIA Connection Manager](#)" on page 551).
- Controller configuration—To set up virtual intranet access for remote users, you must configure your controller to include setting up user roles, authentication, and connection profiles. You can use either WebUI or CLI to configure your controller (see "[Configuring the VIA Controller](#)" on page 553).



NOTE: VIA requires the PEFV license and is supported on the W-600 Series, W-3000 Series, W-7200 Series, and W-6000M3 controller.

Topics in this chapter include:

- "[Understanding VIA Connection Manager](#)" on page 551
- "[Downloading VIA](#)" on page 566
- "[Configuring the VIA Controller](#)" on page 553

Understanding VIA Connection Manager

If a user is connected from a remote location that is outside of the enterprise network, VIA automatically detects the environment as un-trusted and creates a secure IPSec connection between the user and the enterprise network. When the user moves into the trusted network, VIA detects the network type and moves to idle state.

How it Works

VIA provides a seamless connectivity experience to users when accessing an enterprise network resource from an un-trusted or trusted network environment. You can securely connect to your enterprise network from an un-trusted network environment. By default VIA will auto-launch at system start and establish a remote connection. The following table explains the typical behavior:



NOTE: The sequence of events described in [Table 176](#) does not necessarily mean that the events always happen in the order shown in the table.

Table 176: VIA Connectivity Behavior

User action / environment	VIA's behavior
The client / user moves from a trusted to un-trusted environment. <i>Example: From office to a public hot-spot.</i>	Auto-launches and establishes connection to remote network.
The client moves from an un-trusted to a trusted environment.	Auto-launch and stay idle. VIA does not establish remote connection. You can, however, manually connect to a network by selecting an appropriate connection profile from the <i>Settings</i> tab.
While in an un-trusted environment, user disconnects the remote connection.	Disconnects gracefully.
User moves to a trusted environment.	Stays idle and does not connect.
User moves to an un-trusted environment	Stays idle and does not connect. This usually happens, if the user has in a previous occasion disconnected a secure connection by clicking the Disconnect button in VIA. Users can manually connect by one of the following methods: <ol style="list-style-type: none"> 1. Right click on the VIA icon in the system tray and select the Restore option and then select the Connect option to connect using the default connection profile. 2. Right click on the VIA icon in the system tray and select the Connect option.
User clicks the Reconnect button.	Establishes remote connection.
In an un-trusted environment, user restarts the system.	Auto-launches and establishes remote connection.
In an un-trusted environment, user shuts down the system. Moves to a trusted environment and restarts system.	Auto-launches and stays idle.

Installing the VIA Connection Manager

Users can download VIA from a URL provided to them by their IT department and install it on their computers.

On Microsoft Windows Computers

1. Download the installer (*ansetup.msi* or *ansetup64.msi*) from the URL provided by the IT department.
2. Double click the installer file and follow the default prompts.
3. After the installation is complete, the user will be prompted to enter the following:
 - a. Remote server URL—This should be provided by the IT department. The administrator can also provision the URL on the controller. In such cases, the user is required to specify only the username and password.
 - b. Username—The users domain user name.
 - c. Password—The users domain password.
4. Click the **Connect** button to initiate a secure VIA connection. VIA will minimized to system tray after establishing the secure connection.

On Apple MacBooks

1. Download the installer (*ansetup.dmg*) from the URL provided by the IT department.
2. Double click the installer file and follow the default prompts.
3. After the installation is complete, the user will be prompted to enter the following:

- a. Remote server URL—This should be provided by the IT department.
 - b. Username—The users domain user name.
 - c. Password—The users domain password.
4. Go to **System Preferences > Other > select VIA** to view VIA connection details.
 5. Go to **System Preferences > Network**, in the list of network connections select **VIA** to modify login details and remote server address.

Upgrade Workflow

VIA checks for upgrade requirements during the login phase. There are two types of upgrade process: Minimal Upgrade and Complete Upgrade.

Minimal Upgrade

This type of upgrade is initiated for bug fixes and some minor enhancements which requires only some components of the client to be upgraded. When a VPN session is active the upgrade binary is downloaded by VIA from the controller. After the active VIA connection is terminated, the upgrade process is started and the client is upgraded. This type of upgrade does not require a system reboot.

Complete Upgrade

This requires an upgrade to VIA and its underlying network drivers. This type of upgrade requires a system reboot. VIA downloads the upgrade binary from the controller and displays a message about upgrade process after the connection is terminated for that upgrade. The user can choose to proceed or cancel the upgrade process. If the user chooses to upgrade, a system reboot is automatically executed. If the user cancels the upgrade, VIA will prompt the user for an upgrade every time the user terminates a VIA session.



NOTE: See "[Downloading VIA](#)" on page 566 for information about using the desktop application.

VIA Compatibility

The following table shows the compatibility of different versions of VIA with ArubaOS.

Table 177: VIA Compatibility Matrix

ArubaOS Version / Operating System	Microsoft Windows (32-bit) [XP, Vista, Windows 7]	Microsoft Windows (64-bit) [Vista, Windows 7]	Mac OS 10.5, 10.6	Apple iOS 4.2	Android 2.2
ArubaOS 5.0.X	1.0, 1.1, 1.2	—	—	—	—
ArubaOS 6.0.x	1.0, 1.1, 1.2	1.2	—	—	—
ArubaOS 6.1.x and later	1.1, 1.2, 2.0	1.2	1.0	—	—

Configuring the VIA Controller

VIA configuration requires that you first configure VPN settings and then configure VIA settings. See "[Virtual Private Networks](#)" on page 271 for information on configuring VPN settings on your controller.

Before you Begin

The following ports must be enabled before configuring the VIA controller.

- **TCP 443**—During the initializing phase, VIA uses HTTPS connections to perform trusted network and captive portal checks against the controller. It is mandatory that you enable port 443 on your network to allow VIA to perform these checks.
- **UDP 4500**—Required for IPsec transport
- **UDP 500**—Required for VIA 1.0 on Mac OS

Supported Authentication Mechanisms

VIA 1.x and VIA 2.x support different authentication mechanisms:

Authentication mechanisms supported in VIA 1.x

Authentication is performed using IKEv1 only. Phase 0 authentication, which authenticates the VPN client, can be performed using either a pre-shared key or an X.509 certificate (the X.509 certificate must appear in the operating system's "user" certificate store.). If certificates are used for IKE phase 0 authentication, it must be followed by username/password authentication.

The second authentication phase is performed using xAuth, which requires a username and password. The username and password is authenticated against the controller's internal database, a RADIUS server, or an LDAP server. If a RADIUS server is used, it must support the PAP protocol.

Support for two-factor authentication such as token cards is provided in VIA 1.x. Token product like RSA tokens and other token cards are also supported. This includes support for new-pin and next-pin.

Authentication mechanisms supported in VIA 2.x

In addition to the authentication methods supported by VIA 1.x, VIA 2.x adds support for IKEv2. IKEv2 is an updated version that is faster and supports a wider variety of authentication mechanisms. IKEv2 does not have two phases of authentication, only a single phase. VIA supports the following with IKEv2:

- Username/password
- X.509 certificate. Controllers running ArubaOS 6.1 or greater support OCSP for the purpose of validating that a certificate has not been revoked.
- EAP (Extensible Authentication Protocol) including EAP-TLS and EAP-MSCHAPv2.

Other authentication methods:

- Certificates based authentication.
- Smart cards that support a Smart Card Cryptographic Provider (SCCP) API within the operating system. VIA will look for an X.509 certificate in the operating system's certificate store. A smart card supporting a SCCP will cause the certificate embedded within the smart card to automatically appear in the operating system's certificate store.

Suite B Cryptography Support

Suite B is a new set of cryptographic algorithms that are approved by the US Government for use in classified communication. Suite B provides the highest levels of security available today in public, commercial algorithms. Specifically, VIA provides support for:

- RFC 4869—Suite B Cryptographic Suites for IPsec
- AES-GCM 128/256 for bulk data transfer

- ECDSA for digital signatures, including support for X.509v3 certificates using ECDSA keys with p256/p384 curves
- ECDH for key agreement using p256/p384 curves
- SHA-256 and SHA-384 for message digests



NOTE: Suite B support requires a controller running Dell PowerConnect W-Series ArubaOS 6.2 or greater with the Advanced Cryptography License installed. See ["Software Licenses"](#) on page 100 for more information on licenses.

802.11 Suite-B

The bSec protocol is a pre-standard protocol that has been proposed to the IEEE 802.11 committee as an alternative to 802.11i. The main difference between bSec and standard 802.11i is that bSec implements Suite B algorithms wherever possible. Notably, AES-CCM is replaced by AES-GCM, and the Key Derivation Function (KDF) of 802.11i is upgraded to support SHA-256 and SHA-384. In order to provide interoperability with standard Wi-Fi software drivers, bSec is implemented as a shim layer between standard 802.11 Wi-Fi and a Layer 3 protocol such as IP. A controller configured to advertise a bSec SSID will advertise an open network, however only bSec frames will be permitted on the network.

The bSec protocol requires that you use VIA 2.1. or greater on the client device.

Configuring VIA Settings

The following steps are required to configure your controller for VIA. These steps are described in detail in the subsections that follow.

1. Enable VPN Server Module—ArubaOS allows you to connect to the VIA controller using the default user roles. However, to configure and assign specific user roles you must install the Policy Enforcement Firewall Virtual Private Network (PEFV) license. For details, see ["Enable VPN Server Module"](#) on page 556.
2. Create VIA User Roles—VIA user roles contain access control policies for users connecting to your network using VIA. You can configure different VIA roles or use the default VIA role—`default-via-role`. For details, see ["Create VIA User Roles"](#) on page 556.
3. Create VIA Authentication Profile—A VIA authentication profile contains a server group for authenticating VIA users. The server group contains the list of authentication servers and server rules to derive user roles based on the user authentication. You can configure multiple VIA authentication profiles and / or use the default VIA authentication profile created with *Internal* server group. For details, see ["Create VIA Authentication Profile"](#) on page 556.
4. Create VIA Connection Profile— A VIA connection profile contains settings required by VIA to establish a secure connection to the controller. You can configure multiple VIA connection profiles. A VIA connection profile is always associated to a user role and all users belonging to that role will use the configured settings. If you do not assign a VIA connection profile to a user role, the default connection profile is used. For details, see ["Create VIA Connection Profile"](#) on page 557.
5. Configure VIA Web Authentication—A VIA web authentication profile contains an ordered list of VIA authentication profiles. The web authentication profile is used by end users to login to the VIA download page (<https://<server-IP-address>/via>) for downloading the VIA client. Only one VIA web authentication profile is available. If more than one VIA authentication profile is configured, users can view this list and select one during the client login. For details, see ["Configure VIA Web Authentication"](#) on page 561.
6. Associate VIA Connection Profile to User Role—A VIA connection profile has to be associated to a user role. Users will login by authenticating against the server group specified in the VIA authentication profile and are put into that user role. The VIA configuration settings are derived from the VIA connection profile attached to that user role. Default connection profile is used. For details, see ["Associate VIA Connection Profile to User Role"](#) on page 562.

7. Configure VIA Client WLAN Profiles—You can push WLAN profiles to end-user computers that use the Microsoft Windows Wireless Zero Config (WZC) service to configure and maintain their wireless networks. After the WLAN profiles are pushed to end-user computers, they are automatically displayed as an ordered list in the preferred networks. The VIA client WLAN profiles provisioned on the client can be selected from the VIA connection profile described in Step 6. For details, see ["Configure VIA Client WLAN Profiles" on page 562](#).
8. Rebranding VIA and Downloading the Installer—You can use a custom logo on the VIA client and on the VIA download web page. For details, see ["Rebranding VIA and Downloading the Installer" on page 564](#).
9. Download VIA Installer and Version File

Using the WebUI to Configure VIA

The following steps illustrate configuring your controller for VIA using the WebUI.

Enable VPN Server Module

You must install the PEFV license to configure and assign user roles. See [Software Licenses on page 100](#) for licensing requirements.

To install a license:

1. Navigate to **Configuration > Network > Controller** and select the **Licenses** tab on the right hand side.
2. Paste the license key in the **Add New License key** text box and click the **Add** button.

Create VIA User Roles

To create VIA users roles:

1. Navigate to **Configuration > Security > Access Control > User Roles**.
2. Click **Add** to create new policies. Click **Done** after creating the user role and apply to save it to the configuration.

Create VIA Authentication Profile

This following steps illustrate the procedure to create an authentication profile to authenticate users against a server group.

1. Navigate to **Configuration > Security > Authentication > L3 Authentication**.
2. Under the *Profiles* section, expand the **VIA Authentication Profile** option. You can configure the following parameters for the authentication profile:

Table 178: VIA - Authentication Profile Parameters

Parameter	Description
Default Role	This role that will be assigned to the authenticated users.
Max Authentication Failures	Specifies the maximum authentication failures allowed. The default is 0 (zero).
Description	A user friendly name or description for the authentication profile.

3. To create a new authentication profile:
 - a. Enter a name for the new authentication profile under the *VIA Authentication Profiles* section and click the **Add** button.
 - b. Expand the **VIA Authentication Profiles** option and select the new profile name.
4. To modify an authentication profile, select the profile name to configure the default role

The following screenshot uses the default authentication profile.

Figure 179: VIA - Associate User Role to VIA Authentication Profile

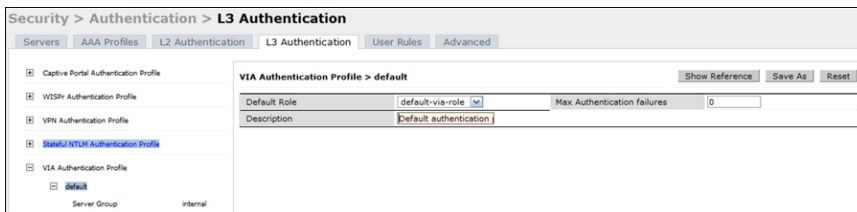

- To use a different server group, Click *Server Group* under VIA Authentication Profile and select *New* to create a new server group.

Figure 180: VIA - Creating a new server group for VIA authentication profile

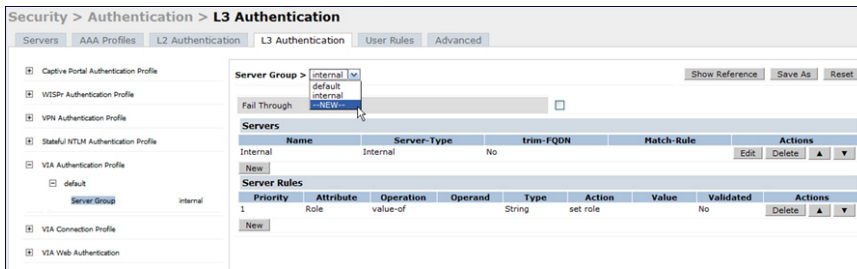

- Enter a name for the server group.

Figure 181: VIA - Enter a name for the server group

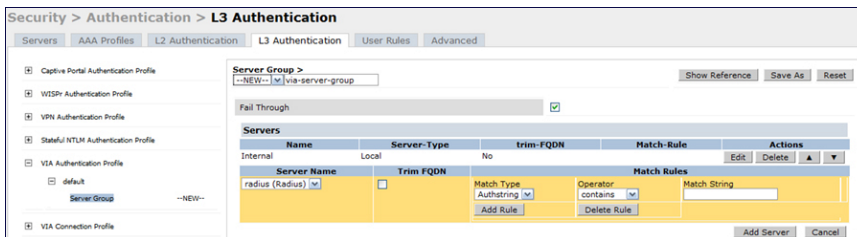

Create VIA Connection Profile

To create VIA connection profile:

- Navigate to *Configuration > Security > Authentication > L3 Authentication* tab. Click the *VIA Connection Profile* option and enter a name for the connection profile.

Figure 182: VIA - Create VIA Connection Profile

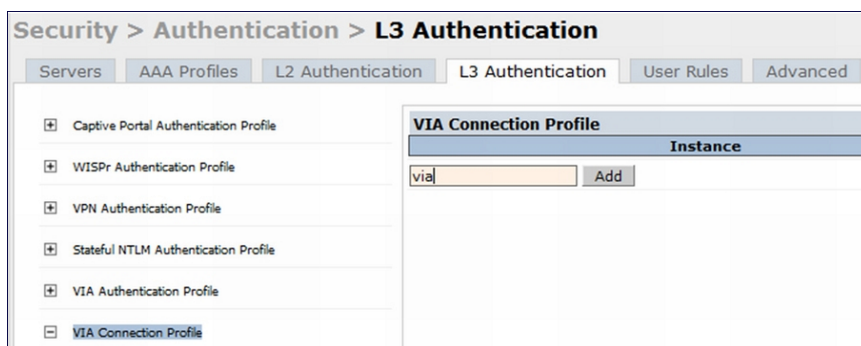

2. Click on the new VIA connection profile to configure the connection settings. VIA Connection profile settings are divided into two tabs, **Basic** and **Advanced**. The **Basic** tab displays only those configuration settings that often need to be adjusted to suit a specific network. The **Advanced** tab shows all configuration settings, including settings that do not need frequent adjustment or should be kept at their default values. If you change a setting on one tab then click and display the other tab without saving your configuration, that setting will revert to its previous value.
3. Click **Apply** to save your changes.

Table 183: VIA - Connection Profile Options

Configuration Option	Description
Basic VIA Connection Profile Settings	
VIA Servers	<p>Enter the following information about the VIA controller.</p> <ul style="list-style-type: none"> ● <i>Controller Hostname/IP Address:</i> This is the public IP address or the DNS hostname of the VIA controller. Users will connect to remote server using this IP address or the hostname. ● <i>Controller Internal IP Address:</i> This is the IP address of any of the VLAN interface IP addresses belongs to this controller. ● <i>Controller Description:</i> This is a human-readable description of the controller. <p>Click the Add button after you have entered all the details. If you have more than one VIA controller you order them by clicking the <i>Up</i> and <i>Down</i> arrows. To delete a controller from your list, select a controller and click the Delete button.</p>
Client Auto-Login	<p>Enable or disable VIA client to auto login and establish a secure connection to the controller. Default: Enabled</p>
VIA tunneled networks	<p>A list of network destination (IP address and netmask) that the VIA client will tunnel through the controller. All other network destinations will be reachable directly by the VIA client.</p> <ul style="list-style-type: none"> ● Enter an IP address & network mask and click the Add button to add to the tunneled networks list. ● To delete a network entry, select the IP address and click the Delete button.
Enable split-tunneling	<p>Enable or disable split tunneling.</p> <ul style="list-style-type: none"> ● If enabled, all traffic to the VIA tunneled networks (Step 3 in this table) will go through the controller and the rest is just bridged directly on the client. ● If disabled, all traffic will flow through the controller. <p>Default: off</p>
Allow client-side logging	<p>Enable or disable client side logging. If enabled, VIA client will collect logs that can be sent</p>

Configuration Option	Description
	to the support email-address for troubleshooting. Default: Enabled
Enable IKEv2	Select this option to enable or disable the use of IKEv2 policies for VIA.
Use Suite B Cryptography	Select this option to use Suite B cryptography methods. You must install the Advanced Cryptography license to use the Suite B cryptography. See "Working with Licenses" on page 101 for more information.
IKEv2 Authentication method	List of all IKEv2 authentication methods.
VIA Client DNS Suffix List	The DNS suffix list (comma separated) that has be set on the client once the VPN connection is established. Default: None.
VIA Support E-mail Address	The support e-mail address to which VIA users will send client logs. Default: None.
Advanced VIA Connection Profile Settings	
VIA Servers	<p>Enter the following information about the VIA controller.</p> <ul style="list-style-type: none"> ● Hostname/IP Address: This is the public IP address or the DNS hostname of your VIA Server / controller. Users will connect to this remote server using the IP address or the hostname. ● Internal IP Address: This is the IP address of any of the VLAN interface IP addresses belonging to this VIA server. ● Description: This is a human-readable description of the VIA server. Click the Add button after you have entered all the details. <p>If you have more than one VIA controller you re-order them by clicking the Up and Down arrows. To delete a VIA server from your list, select a server and click Delete.</p>
Client Auto-Login	Select this checkbox to allow a VIA client to automatically log in and establish a secure connection to the controller. Default: Enabled
VIA Authentication Profiles to provision	<p>This is the list of VIA authentication profiles that will be displayed to users in the VIA client. See "Create VIA Connection Profile" on page 557</p> <ul style="list-style-type: none"> ● Select an authentication profile and click the Add button to add to the authentication profiles list. ● You can change the order of the list by clicking the <i>Up</i> and <i>Down</i> arrows. ● To delete an authentication profile, select a profile name and click the Delete button.
Allow client to auto-upgrade	Enable or disable VIA client to automatically upgrade when an updated version of the client is available on the controller. Default: Enabled
VIA tunneled networks	A list of network destination (IP address and netmask) that the VIA client will tunnel through the controller. All other network destinations will be reachable directly by the VIA client. Enter an IP address and network mask, then click Add button to add them to the tunneled networks list. To delete a network entry, select the IP address and click Delete .
Enable split-tunneling	Enable or disable split tunneling. If enabled, all traffic to the VIA tunneled networks) will go through the controller and the rest is just bridged directly on the client. If disabled, all traffic will flow through the controller. Default: off
VIA Client WLAN profiles	A list of VIA client WLAN profiles that needs to be pushed to the client machines that use

Configuration Option	Description
	<p>Windows Zero Config (WZC) to configure or manage their wireless networks.</p> <ul style="list-style-type: none"> • Select a WLAN profile and click the Add button to add to the client WLAN profiles list. • To delete an entry, select the profile name and click the Delete button. <p>See "Configure VIA Client WLAN Profiles" on page 562 for more information.</p>
VIA IKE V2 Policy	List of available IKEv2 policies.
VIA IKE Policy	List of IKE policies that the VIA Client has to use to connect to the controller. These IKE policies are configured under Configuration > Advanced Services > VPN Services > IPSEC > IKE Policies .
Use Windows Credentials	Enable or disable the use of the Windows credentials to login to VIA. If enabled, the SSO (Single Sign-on) feature can be utilized by remote users to connect to internal resources. Default: Enabled
VIA IPsec V2 Crypto Map	List of all IPsec V2 that the VIA client uses to connect to the controller.
VIA IPsec Crypto Map	List of IPsec Crypto Map that the VIA client uses to connect to the controller. These IPsec Crypto Maps are configured in CLI using the <code>crypto-local ipsec-map <ipsec-map-name></code> command.
VIA Client Network Mask	The network mask that has to be set on the client after the VPN connection is established. Default: 255.255.255.255
Enable Supplicant	If enabled, VIA starts in bSec mode using L2 suite-b cryptography. This option is disabled by default.
Enable FIPS Module	Enable the VIA (Federal Information Processing Standard) FIPS module so VIA checks for FIPS compliance during startup. This option is disabled by default.
Auto-Launch Supplicant	Select this option to automatically connect to a configured WLAN network.
Lockdown all Settings	If enabled, all user options on the VIA client are disabled.
Domain Suffix in VIA Authentication	Enables a domain suffix on VIA Authentication, so client credentials are sent as domain-name\username instead of just username..
Enable Controllers Load Balance	Enable this option to allow the VIA client to failover to the next available selected randomly from the list as configured in the VIA Servers option. If disabled, VIA will failover to the next in the sequence of ordered list of VIA Servers.
Enable Domain Preconnect	Enable this option to allow users with lost or expired passwords to establish a VIA connection to corporate network. This option authenticates the user's device and establishes a VIA connection that allows users to reset credentials and continue with corporate access.
VIA Banner Message Reappearance Timeout(minutes)	The maximum time (minutes) allowed before the VIA login banner reappears. Default: 1440 min
VIA Client Network Mask	VIA client network mask, in dotted decimal format.
Validate Server Certificate	Enable or disable VIA from validating the server certificate presented by the controller. Default: Enabled
VIA max session timeout	The maximum time (minutes) allowed before the VIA session is disconnected. Default: 1440 min

Configuration Option	Description
VIA Logon Script	Specify the name of the logon script that must be executed after VIA establishes a secure connection. The logon script must reside in the client computer.
VIA Logoff Script	Specify the name of the log-off script that must be executed after the VIA connection is disconnected. The logoff script must reside in the client computer.
Maximum reconnection attempts	The maximum number of re-connection attempts by the VIA client due to authentication failures. Default: 3
VIA external download URL	End users will use this URL to download VIA on their computers.
Allow user to disconnect VIA	Enable or disable users to disconnect their VIA sessions. Default: on
Comma separated list of HTTP ports to be inspected (apart from default port 80)	Traffic from the specified ports will be verified by the content security service provider.
Keep VIA window minimized	Enable this option to minimize the VIA client to system tray during the connection phase. Applicable to VIA client installed in computers running Microsoft Windows operating system.
Block traffic until VPN tunnel is up	If enabled, this feature will block network access until the VIA VPN connection is established.
Block traffic rules	Specify a hostname or IP address and network mask to define a whitelist of users to which the Block traffic until VPN tunnel is up setting will not apply.

Configure VIA Web Authentication

To configure VIA web authentication profile:

1. Navigate to **Configuration > Security > Authentication > L3 Authentication** tab.
2. Expand VIA Web Authentication and click on *default* profile.



NOTE: You can have only one profile (*default*) for VIA web authentication.

3. Select a profile from **VIA Authentication Profile** drop-down list box and click the **Add** button.
 - To re-order profiles, click the *Up* and *Down* button.
 - To delete a profile, select a profile and click the **Delete** button.
4. If a profile is not selected, the *default* VIA authentication profile is used.

Figure 184: VIA - Select VIA Authentication Profile

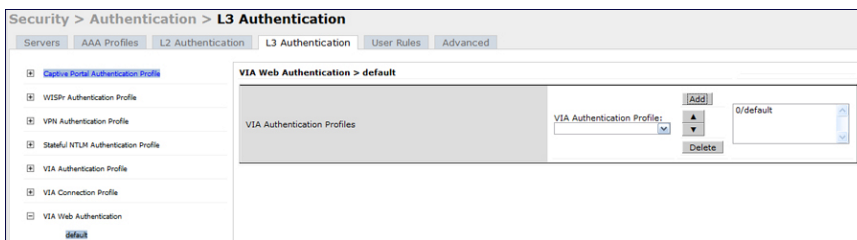

Associate VIA Connection Profile to User Role

To associate a VIA connection profile to a user role:

1. Navigate to **Configuration > Security > Access Control > User Roles** tab.
2. Select the VIA user role (See "Create VIA User Roles" on page 556) and click the **Edit** button.
3. In the *Edit Role* page, navigate to VIA Connection Profile and select the connection profile from the drop-down list box and click the **Change** button.
4. Click the **Apply** button to save the changes to the configuration.

Figure 185: VIA - Associate VIA Connection Profile to User Role

The screenshot shows a configuration page for a user role. The 'VIA Connection Profile' section is highlighted, showing a dropdown menu with 'Not Assigned' selected. Other sections include 'Re-authentication Interval' (Disabled), 'Role VLAN ID' (Not Assigned), 'Bandwidth Contract' (Upstream/Downstream: Not Enforced), 'VPN Dialer' (Not Assigned), 'L2TP Pool' (default-l2tp-pool), 'PPTP Pool' (default-pptp-pool), 'Captive Portal Profile' (Not Assigned), 'Max Sessions' (65535), 'Stateful NTLM Profile' (Not Assigned), and 'WISPr Profile' (Not Assigned).

Configure VIA Client WLAN Profiles

To configure a VIA client WLAN profile:

1. Navigate to **Configuration > Advanced Services > All Profiles**.
2. Expand *Controller Profiles* and select **VIA Client WLAN Profile**.
3. In the Profile Details, enter a name for the WLAN profile and click the **Add** button.

Figure 186: VIA - Create VIA Client WLAN Profile

The screenshot shows the 'Advanced Services > All Profile Management' page. The 'VIA Client WLAN Profile' is selected in the left-hand navigation pane. The main area shows the 'Instance' configuration for the selected profile, with a text input field containing 'office-wifi' and an 'Add' button.

4. Expand the new WLAN profile and click **SSID Profile**. In the profile details page, select **New** from the SSID Profile drop-down box and enter a name for the SSID profile.

- In the Basic tab, enter the network name (SSID) and select 802.11 security settings. Click the **Apply** button to continue.

Figure 187: VIA - Configure the SSID Profile

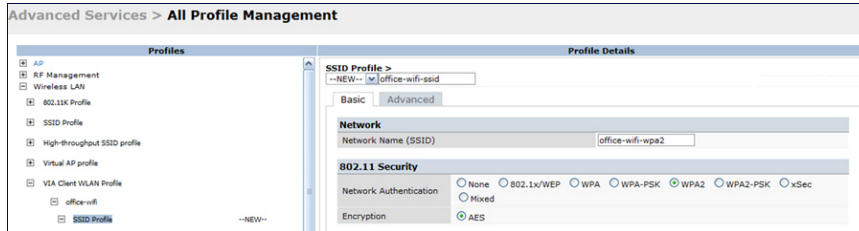

- You can now configure the SSID profile by select the SSID profile under VIA Client WLAN Profile option.

Figure 188: VIA - Configure VIA Client WLAN Profile

EAP Type	eap-peap	Inner EAP Type	eap-mschapv2
EAP-PEAP options	<input type="checkbox"/> validate-server-certificate <input type="checkbox"/> enable-quarantine-checks <input type="checkbox"/> dont-allow-user-authorization	<input checked="" type="checkbox"/> enable-fast-reconnect <input type="checkbox"/> disconnect-if-no-cryptobinding-tlv	
EAP-Certificate options	<input type="checkbox"/> use-smartcard <input type="checkbox"/> simple-certificate-selection <input type="checkbox"/> use-different-name	<input checked="" type="checkbox"/> validate-server-certificate	
Inner EAP Authentication options	<input type="checkbox"/> mschapv2-use-windows-credentials <input type="checkbox"/> use-smartcard <input type="checkbox"/> simple-certificate-selection <input type="checkbox"/> use-different-name	<input checked="" type="checkbox"/> validate-server-certificate	
Automatically connect when this WLAN is in range	<input checked="" type="checkbox"/>	EAP-PEAP: Connect only to these servers	<input type="text"/>
Enable IEEE 802.1x authentication for this network	<input checked="" type="checkbox"/>	EAP-Certificate: Connect only to these servers	<input type="text"/>
Authenticate as computer when computer info is available	<input checked="" type="checkbox"/>	Inner EAP-Certificate: Connect only to these servers	<input type="text"/>
Authenticate as guest when computer or user info is unavailable	<input type="checkbox"/>	Connect even if this WLAN is not broadcasting	<input type="checkbox"/>

The VIA client WLAN profile are similar to the authentication settings used to set up a wireless network in Microsoft Windows. The following table shows the Microsoft Windows equivalent settings:

Table 189: Configure VIA client WLAN profile

Option	Description
EAP-PEAP options	Select the following options, if the EAP type is PEAP (Protected EAP): <ul style="list-style-type: none"> validate-server-certificate: Select this option to validate server certificates. enable-fast-reconnect: Select this option to allow fast reconnect. enable-quarantine-checks: Select this option to perform quarantine checks. disconnect-if-no-cryptobinding-tlv: Select this option to disconnect if server does not present cryptobinding TLV. dont-allow-user-authorization: Select this to disable prompts to user for authorizing new servers or trusted certification authorities.
EAP Type	Select an EAP type used by client to connect to wireless network. Default: EAP-PEAP
EAP-Certificate Options	If you select EAP type as certificate, you can select one of the following options: <ul style="list-style-type: none"> mschapv2-use-windows-credentials use-smartcard

Option	Description
	<ul style="list-style-type: none"> • simple-certificate-selection • use-different-name • validate-server-certificate
Inner EAP Type	Select the inner EAP type. Default: EAP-MSCHAPv2
Inner EAP Authentication options:	<ul style="list-style-type: none"> • mschapv2-use-windows-credentials: Automatically use the Windows logon name and password (and domain if any) • use-smartcard: Use a smart card • simple-certificate-selection: Use a certificate on the users computer or use a simple certificate selection method (recommended) • validate-server-certificate: Validate the server certificate • use-different-name: Use a different user name for the connection (and not the CN on the certificate)
Automatically connect when this WLAN is in range	Select this option if you want VIA client to connect when this network (SSID) is available.
EAP-PEAP: Connect only to these servers	Comma separated list of servers.
Enable IEEE 802.1X authentication for this network	Select this option to enable 802.1X authentication for this network. Default: Enabled.
EAP-Certificate: Connect only to these certificates	Comma separated list of servers.
Inner EAP-Certificate: Connect only to these servers	Comma separated list of servers.
Connect even if this WLAN is not broadcasting	Default: Disabled

Rebranding VIA and Downloading the Installer

You can re-brand the VIA client and the VIA download page with your custom logo and HTML page.

Figure 190: VIA - Customize VIA logo, Landing Page, and download VIA Installer

The screenshot shows a web interface for configuring VIA installers. At the top, it says "VIA installers for various platforms" and "Win32 (Windows XP, Windows Vista, Windows 7)" with a version number "1.1.0.2452". There are two main sections: "Customize Logo" and "Customize Welcome HTML". Each section has a "Choose File" button, an "Upload" button, and a "Reset" button. Below the "Customize Welcome HTML" section, there is a "View 1 Download" link and an "Apply" button. At the bottom, there is a "Commands" section with a "View Commands" link.

Download VIA Installer and Version File

To download the VIA installer and version file:

1. Navigate to the **Configuration > Advanced Services > VPN Services > VIA** tab.
2. Under VIA installers for various platforms section, click **ansetup.msi** to download the installation file.

Customize VIA Logo

To use a custom logo on the VIA download page and the VIA client:

1. Navigate to the **Configuration > Advanced Services > VPN Services > VIA** tab.
2. Under *Customize Logo* section, browse and select a logo from your computer. Click the **Upload** button to upload the image to the controller.
 - To use the default Dell logo, click the **Reset** button.

Customize the Landing Page for Web-based Login

To use a custom landing page for VIA web login:

1. Navigate to the **Configuration > Advanced Services > VPN Services > VIA** tab.
2. Under *Customize Welcome HTML* section, browse and select the HTML file from your computer. Click the **Upload** button to upload the image to the controller.
3. The following variables are used in the custom HTML file:

All variables in the custom HTML file have the following notation

- `<% user %>`: this will display the username.
- `<% ip %>`: this will display the IP address of the user.
- `<% role %>`: this will be display the user role.
- `<% logo %>`: this is the custom logo (Example: ``)
- `<% logout %>`: the logout link (Example: `<a href="<% logout %>">VIA Web Logout`)
- `<% download %>`: the installer download link (Example: `<a href="<% download %>">Click here to download VIA`)

To use the default welcome page, click the **Reset** button.

4. Click the **Apply** button to continue.

Using the CLI to Configure VIA

The following steps illustrate configuring VIA Using the CLI. Install your Policy Enforcement Firewall Virtual Private Network (PEFV) license key. For detailed information on the VIA command line options, see the *Dell PowerConnect W-Series ArubaOS 6.2 Command Line Reference Guide*.

```
(host) (config)# license add <key>
```

Create VIA roles

```
(host) (config) #user-role example-via-role
(host) (config-role) #access-list session "allowall" position 1
(host) (config-role) #ipv6 session-acl "v6-allowall" position 2
```

Create VIA authentication profiles

```
(host) (config) #aaa server-group "via-server-group"
(host) (Server Group "via-server-group") #auth-server "Internal" position 1
(host) (Server Group "via-server-group") #aaa authentication via auth-profile default
(host) (VIA Authentication Profile "default") #default-role example-via-role
(host) (VIA Authentication Profile "default") #desc "Default VIA Authentication Profile"
(host) (VIA Authentication Profile "default") #server-group "via-server-group"
```

Create VIA connection profiles

```
(host) (config) #aaa authentication via connection-profile "via"
(host) (VIA Connection Profile "via") #server addr 202.100.10.100 internal-ip 10.11.12.13
desc "VIA Primary" position 0
(host) (VIA Connection Profile "via") #auth-profile "default" position 0
```

```
(host) (VIA Connection Profile "via") #tunnel address 10.0.0.0 netmask 255.255.255.0
(host) (VIA Connection Profile "via") #split-tunneling
(host) (VIA Connection Profile "via") #windows-credentials
(host) (VIA Connection Profile "via") #client-netmask 255.0.0.0
(host) (VIA Connection Profile "via") #dns-suffix-list example.com
(host) (VIA Connection Profile "via") #support-email via-support@example.com
```

Enter the following command after you create the client WLAN profile. See ["Configure VIA Client WLAN Profiles" on page 562](#)

```
(host) (VIA Connection Profile "via") #client-wlan-profile "via_corporate_wpa2" position 0
```

Configure VIA web authentication

```
(host) (config) #aaa authentication via web-auth default
(host) (VIA Web Authentication "default") #auth-profile default position 0
```



NOTE: You can have only one profile (*default*) for VIA web authentication.

Associate VIA connection profile to user role

```
(host) (config) #user-role "example-via-role"
(host) (config-role) #via "via"
```

Configure VIA client WLAN profiles

```
(host) (config) #wlan ssid-profile "via_corporate_wpa2"
(host) (SSID Profile "via_corporate_wpa2") #essid corporate_wpa2
(host) (SSID Profile "via_corporate_wpa2") #opmode wpa2-aes
(host) (SSID Profile "via_corporate_wpa2") #wlan client-wlan-profile "via_corporate_wpa2"
(host) (VIA Client WLAN Profile "via_corporate_wpa2") #ssid-profile "via_corporate_ssid"
```

For detailed configuration parameter information, see “*wlan client-wlan-profile*” command in the *Dell PowerConnect W-Series ArubaOS 6.2 Command Line Reference Guide*.

Customize VIA logo, landing page and downloading installer

This step can only be performed using the WebUI. See ["Rebranding VIA and Downloading the Installer" on page 564](#).

Downloading VIA

This section of the document provides instructions and information on using VIA.

Pre-requisites

Ensure that the end-user system meets the following prerequisites:

- VIA can be installed only on systems running:
 - Microsoft Windows XP with SP2
 - Microsoft Windows Vista (32-bit and 64-bit)
 - Microsoft Windows 7 (32-bit and 64-bit)



NOTE: VIA is supported only in the English versions of Microsoft Windows. International versions of Microsoft Windows is not supported.

- Requires the following Microsoft KB on the end-user systems:

- On Microsoft Windows XP SP2—KB918997 (<http://support.microsoft.com/kb/918997>)
Install this to see the list of detected wireless networks in the VIA client (**Diagnostics** tab > **Detected Networks** page).
- On Microsoft Windows XP SP3—KB958071 (<http://support.microsoft.com/kb/958071>)
Install this if you receive the “1206 (ERROR_BAD_PROFILE)” error code.
- Administrator rights on the computer.
- The computer must have a working wired or wireless network hardware.

Downloading VIA

In a typical scenario, end users will receive an email from their IT department with details to download VIA from a URL (Dell controllers public IP address). See [Table 183](#).

In this example, they can download VIA set up files from <https://115.52.100.10/via> after entering their corporate credentials.

Figure 191: Login to Download VIA

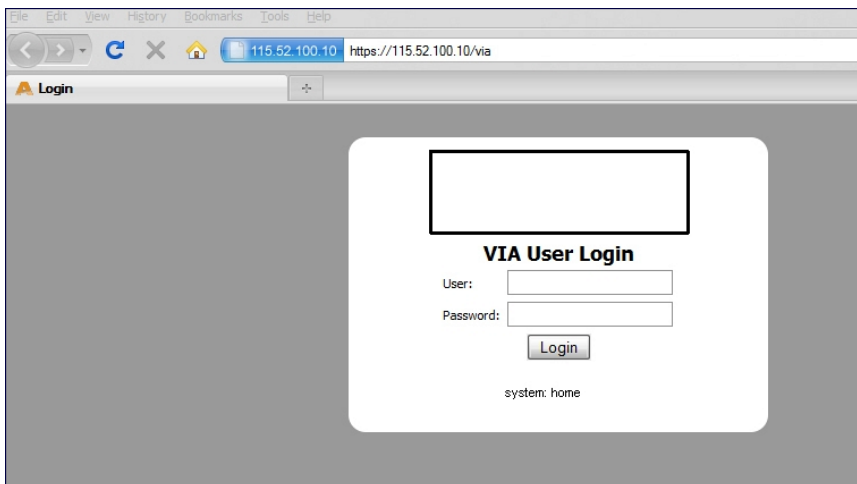
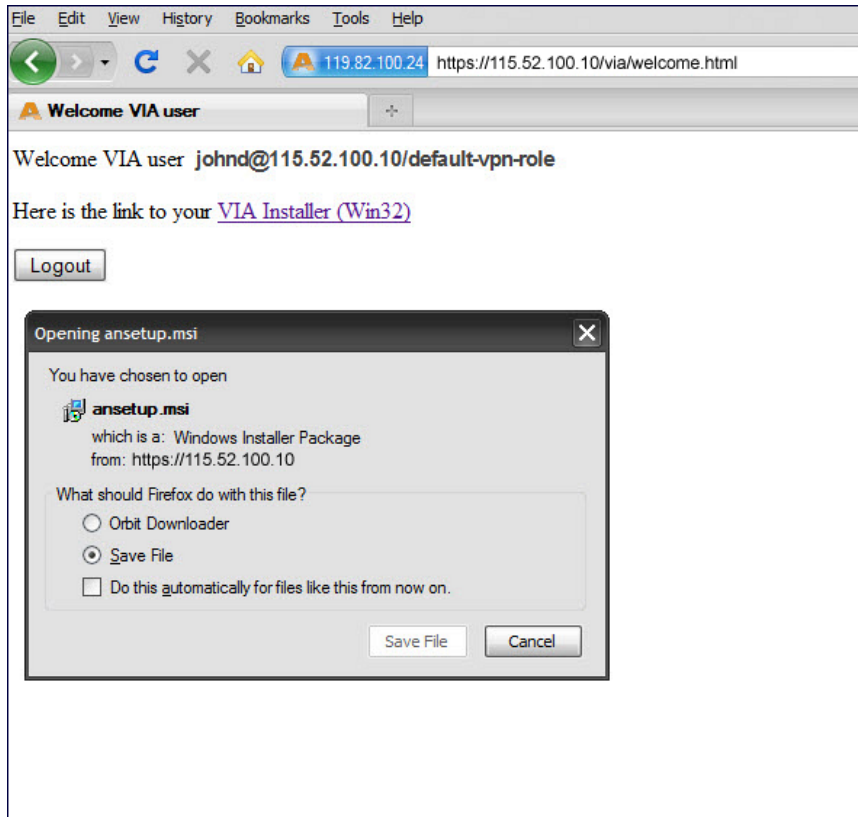

Figure 192: Downloading VIA set up file after authentication



Installing VIA

Double click the downloaded set up file (*ansetup.msi* or *ansetup64.msi*) to start the installation process. Ensure that you have met the pre-requisites before proceeding with the installation.

Using VIA

The VIA desktop application has three tabs:

- Connection Details
- Diagnostics
- Settings

Connection Details Tab

Provides all required details about your remote connection. After a successful connection, you can see the assigned IP from your remote server, the profile used for the connection and other network related information.

- Disconnect—Click this button to disconnect the current remote connection. You will have to manually connect for the next connection. VIA will not automatically start connection.
- View Connection Log—Click this button to view the sequence of events that took place during the last or current connection. The log also provide information about upgrade requirement, missing pre-requisites or other encountered errors.

- **Change Profile**—Click this button to select an alternate connection profile. This button is enabled only if your administrator has configured more than one connection profile. This button toggles to **Download Profile**, if you clear your profile from the Settings tab.

More Details

This section gives information about your local connection.

- Click **Network Details** to view local network connection information.
- Click **VIA Details** to view error or other connection messages.

Diagnostic Tab

Provides information and tools for troubleshooting your connectivity issues. Select a diagnostic tool from this tab for more information.

- **Connection Logs**—Sequence of events that happened during the recent connection.
- **Send Logs**—List of logs files collected by VIA. You can send this to your technical support when required. Click **Open Folder** to see the folder with the most recent logs and click the **Send** button to send log files archive using your default e-mail client.
- **View system info & Advanced info**—System and network configuration details of your system.
- **Connectivity tests**—Basic tests (ping and trace-route) to verify your network connection.
- **Detected Networks**—If your system has wireless network capability, this option will show all detected wireless networks.
- **VIA info**—Information about the current VIA installation.
- **Compatibility info**—Compatibility information about some applications detected in your system.

Settings Tab

This tab allows you to configure extra settings required to collect log, use a different connection profile and set up proxy server details.

- **Log Settings**—Allows you to set VIA log levels. By default, the log level is set to *Trace*. This setting captures extensive activity information about VIA.
- **Connection Profile**—Allows you to select and connect to a different connection profile. This is usually useful if you are in remote location and you need to connect to your corporate (secure) network. In such situation, you can select a profile that uses the nearest remote server to provide secure connection to your network. Alternate connection profiles are available only if it is configured by your IT administrator.
- **Proxy Settings**—Detects and displays Microsoft Internet Explorer proxy server details. It also allows you to enter the proxy authentication credentials to be used for HTTP/HTTPS connection to the controller.

Troubleshooting

To enable your support team to effectively resolve your VIA connection issues, it is mandatory that you send logs generated by VIA. To do this, click the **Send Logs** button from the **Connection Details** tab.

Chapter 32

Spectrum Analysis

Wireless networks operate in environments with electrical and radio frequency devices that can interfere with network communications. Microwave ovens, cordless phones, and even adjacent Wi-Fi networks are all potential sources of continuous or intermittent interference. The spectrum analysis software modules on APs that support this feature are able to examine the radio frequency (RF) environment in which the Wi-Fi network is operating, identify interference and classify its sources. An analysis of the results can then be used to quickly isolate issues with packet transmission, channel quality, and traffic congestion caused by contention with other devices operating in the same band or channel.

AP radios that gather spectrum data but do not service clients are called spectrum monitors, or SMs. Each SM scans and analyzes the spectrum band used by the SM's radio (2.4GHz or 5GHz). An AP radio in *hybrid AP* mode continues to serve clients as an access point while it analyzes spectrum analysis data for the channel the radio uses to serve clients. You can record data for both types of spectrum analysis devices, save that data, and then play it back for later analysis.

Topics in this chapter include:

- ["Understanding Spectrum Analysis" on page 570](#)
- ["Creating Spectrum Monitors and Hybrid APs" on page 574](#)
- ["Connecting Spectrum Devices to the Spectrum Analysis Client" on page 577](#)
- ["Configuring the Spectrum Analysis Dashboards" on page 579](#)
- ["Customizing Spectrum Analysis Graphs" on page 582](#)
- ["Working with Non-Wi-Fi Interferers " on page 606](#)
- ["Understanding the Spectrum Analysis Session Log" on page 608](#)
- ["Viewing Spectrum Analysis Data" on page 608](#)
- ["Recording Spectrum Analysis Data" on page 609](#)
- ["Troubleshooting Spectrum Analysis" on page 612](#)

Understanding Spectrum Analysis

The table below lists the AP models that support the spectrum analysis feature. Single-radio mesh APs do not support the spectrum analysis feature; if an AP radio has a virtual AP carrying mesh backhaul traffic, no other virtual AP on that radio can be configured as a spectrum monitor. However, dual-radio mesh APs can have the client access radio configured as a Spectrum monitor or hybrid AP while the other radio supports mesh backhaul traffic.

Table 193: *Device Support for Spectrum Analysis*

Device	Configurable as a Spectrum Monitor?	Configurable as a Hybrid AP?
W-AP104	Yes	Yes

Device	Configurable as a Spectrum Monitor?	Configurable as a Hybrid AP?
W-AP105	Yes	Yes
W-AP92	Yes	Yes
W-AP93	Yes	Yes
W-AP93H	Yes	No
W-AP120 Series	Yes	No
W-AP130 Series	Yes	Yes
W-AP175 Series	Yes	No
W-IAP3WN Series	Yes	No

The radios on groups of APs can be converted to dedicated spectrum monitors or hybrid APs via the AP group's dot11a and dot11g radio profiles. Individual APs can also be converted to spectrum monitors through the AP's spectrum override profile.



NOTE: The spectrum analysis feature requires the RF Protect license. In order to convert an AP to a spectrum monitor or hybrid AP, you must have an AP license *and* an RF protect license for each AP on that controller.

The Spectrum Analysis section of the WebUI includes the **Spectrum Monitors**, **Session Log**, and **Spectrum Dashboards** windows.

- **Spectrum Monitors:** The **Spectrum Monitors** window displays a list of active spectrum monitors and hybrid APs streaming data to your client, the radio band the device is monitoring, and the date and time the SM or hybrid AP was connected to your client. This window allows you to select the spectrum monitors or hybrid APs for which you want to view information, and release the connection between your client and any device you no longer want to view.
- **Session Log:** This tab displays activity for spectrum monitors and hybrid APs during the current browser session, including timestamps showing when the devices were connected to and disconnected from the client, and any changes to a hybrid APs monitored channel.
- **Spectrum Dashboards:** The **Spectrum Dashboards** window shows different user-customizable data charts for 2.4GHz and 5 GHz spectrum monitor or hybrid AP radios. [Table 194](#) below gives a basic description of each of the spectrum analysis graphs that can appear on the spectrum dashboard



NOTE: For more detailed information on these graphs, refer to "[Customizing Spectrum Analysis Graphs](#)" on page 582.

Table 194: Spectrum Analysis Graphs

Graph Title	Description	Update Interval
Active Devices Table	A pie chart showing the percentages and total numbers of each device type for all active devices. This graph has no set update interval; the graph automatically updates when values change. For details, see " Active Devices " on page 583.	N/A

Graph Title	Description	Update Interval
Active Devices Trend	A line chart showing the numbers of up to five different types of Wi-Fi and non-Wi-Fi devices seen on selected channels during a specified time interval. This chart can show devices on multiple channels for a spectrum monitor, or the single monitored channel for a hybrid AP. For details, see "Active Devices Trend" on page 587 .	Updates every 5 seconds
Channel Metrics	This stacked bar chart shows the current relative quality, availability or utilization of selected channels in the 2.4 GHz or 5 GHz radio bands. This chart can show multiple channels for a spectrum monitor, or the single monitored channel for a hybrid AP. For details, see "Channel Metrics" on page 588 .	Updates every 5 seconds
Channel Metrics Trend	A line chart showing the relative quality or availability of selected channels in the 2.4 GHz or 5 GHz radio bands over a specified time interval. Spectrum monitors can show channel data for multiple channels, while a hybrid AP shows information only for its one monitored channel. For details, see "Channel Metrics Trend" on page 590 .	Updates every 5 seconds
Channel Summary Table	The Channel Summary table displays the number of devices found on each channel in the spectrum monitor's radio band, the percentage of channel utilization, and AP power and interference levels. Spectrum monitors can show data for multiple channels, while a hybrid AP shows a channel summary only for its one monitored channel. For details, see "Channel Summary Table" on page 592 .	Updates every 5 seconds
Channel Utilization Trend	A line chart that shows the channel utilization for one or more radio channels, as measured over a defined time interval. Spectrum monitors can show data for multiple channels, while a hybrid AP shows utilization levels for its one monitored channel only. For details, see "Channel Utilization Trend" on page 594 .	Updates every 5 seconds
Device Duty Cycle	A stacked bar chart showing the percent of each channel in the spectrum monitor radio's frequency band utilized by a Wi-Fi AP or any other device type detected by the spectrum monitor. The Device Duty Cycle chart for a hybrid AP only shows data for the one channel monitored by the hybrid AP. This chart is not available for W-AP120 Series or W-AP68 access points. For details, see "Device Duty Cycle" on page 593 .	Updates every 5 seconds
Devices vs Channel	A stacked bar chart showing the total numbers of each device type detected on each channel in the spectrum monitor radio's frequency band. The Devices vs Channel chart for a hybrid AP only shows data for the one channel monitored by the hybrid AP. For details, see "Devices vs Channel" on page 595 .	Updates every 5 seconds
FFT Duty Cycle	Fast Fourier Transform, or FFT , is an algorithm for computing the frequency spectrum of a time-varying input signal. This line chart shows the FFT duty cycle, which represents the percent of time a signal is broadcast on the specified channel or frequency. Spectrum monitors can show data for multiple channels, while a hybrid AP shows information only for its one monitored channel. This chart is not available for W-AP120 Series or W-AP68 access points. For details, see "FFT Duty Cycle" on page 597 .	Updates every second
Interference Power	This chart shows information about Wi-Fi interference, including the Wi-Fi noise floor, and the amount of adjacent channel interference from cordless phones, bluetooth devices and microwaves. Spectrum monitors can show	Updates every 5 seconds

Graph Title	Description	Update Interval
	interference power data for multiple channels, while a hybrid AP shows information only for its one monitored channel. For details, see "Interference Power" on page 598.	
Quality Spectrogram	This plot shows quality statistics for selected range of channels or frequencies as determined by the current noise floor, non-Wi-Fi (interferer) utilization and duty-cycles and certain types of retries. This chart can also be configured to show channel availability, the percentage of each channel that is unused and available for additional traffic. Spectrum monitors can show data for multiple channels, while a hybrid AP shows information only for its one monitored channel. For details, see "Quality Spectrogram" on page 600.	Updates every 5 seconds
Real-Time FFT	Fast Fourier Transform, or FFT , is an algorithm for computing the frequency spectrum of a time-varying input signal. This line chart shows the power level of a signal on the channels or frequencies monitored by a spectrum monitor radio. Spectrum monitors can show data for multiple channels, while a hybrid AP shows information only for its one monitored channel. This chart is not available for W-AP120 Series or W-AP68 access points. For details, see "Real-Time FFT" on page 601.	Updates every second
Swept Spectrogram	This plot displays FFT power levels For details, see or the FFT duty cycle for a selected channel or frequency, as measured during each time tick. Spectrum monitors can show data for multiple channels, while a hybrid AP shows information only for its one monitored channel. This chart is not available for W-AP120 Series or W-AP68 access points. For details, see "Swept Spectrogram" on page 603.	Updates every second

Spectrum Analysis Clients

The maximum number of spectrum monitor radios and hybrid AP radios on a controller is limited only by the number of APs on that controller. If desired, you can configure every radio on an AP that supports the Spectrum Analysis feature as a spectrum device. A dual-radio AP can operate as two spectrum devices, since each radio can be individually configured as a spectrum monitor (SM) or hybrid AP.

A spectrum analysis client can simultaneously access data from up to four individual spectrum device radios. Each spectrum device radio, however, can only be connected to a single client WebUI.

When you select a specific spectrum monitor or hybrid AP radio to stream data to your client, the controller first checks the availability of the device, to verify that it is not subscribed to some other client. Once the SM or hybrid AP radio has been verified as available, the SM or hybrid AP establishes a connection to the client and begins sending spectrum analysis data either every second or every five seconds, depending on the type of data being requested. Each client may select up to twelve different spectrum analysis charts and graphs to appear in the spectrum dashboard.

A controller can support up to 22 active WebUI connections. If spectrum analysis clients are simultaneously viewing data for than 22 WebUI connections, any additional WebUI requests are refused until some clients close their WebUI browser sessions.

When you finish reviewing data from an SM or hybrid AP, you should disconnect the device from your spectrum client. Do not forget this important step—no other user can access data from that spectrum monitor or hybrid AP until you release your subscription. Note, however, that when you disconnect a spectrum monitor from your client, **the AP continues to operate as a spectrum monitor** until you return it to AP mode by removing the local spectrum override, or by changing the mode parameter in the AP's 802.11a or 802.11g radio profile from spectrum-mode back to AP-mode.



NOTE: A spectrum monitor or hybrid AP automatically disconnects from a client when you close the browser window you used to connect the spectrum monitor to your client. However, if you are using Internet Explorer and have multiple instances of an Internet Explorer browser open, the data-streaming connection to the spectrum monitor or hybrid AP is not released until 60 seconds after you close the spectrum client browser window. During this 60-second period, the spectrum monitor is still connected to the client.

When a spectrum monitor or hybrid AP is not subscribed to any client, it still performs all classification tasks and collect all necessary channel lists and device information. You can view classification, device and channel information for any active spectrum monitor or hybrid AP via the controller's command-line interface, regardless of whether or not that device is sending real-time spectrum data to another client WebUI.

Individual spectrum analysis graphs and charts are explained in detail in ["Customizing Spectrum Analysis Graphs" on page 582](#).

Hybrid AP Channel Changes

By default, a hybrid AP only monitors the channel specified in its 802.11a or 802.11g radio profile for spectrum interference. If you want to change the channel monitored by a hybrid AP, you must edit the channel setting in those profiles. There are, however, other ArubaOS features that may automatically change the channels on hybrid APs. APs using Dynamic Frequency Selection (DFS) perform off-channel scanning to detect the presence of satellite and radar transmissions, and switch to a different channel if it detects that satellite or radar transmissions are present. APs using the Adaptive Radio Response (ARM) feature constantly monitor the network and automatically select the best channel and transmission power settings for that AP. If you manually change a channel monitored by a hybrid AP, best practices are to temporarily disable the ARM feature, as ARM may automatically return the channel to its previous setting.

If a hybrid AP is using ARM or DFS, that hybrid AP may automatically move to a different channel in response to changes in the network environment. If a hybrid AP changes channels while it is connected to a spectrum analysis client, the hybrid AP updates the graphs in the spectrum dashboard to start displaying spectrum data for the new channel, and sends a log message to the session log. For details on changing the channel monitored by a hybrid AP, see ["802.11a and 802.11g RF Management Profiles" on page 424](#).

Hybrid APs Using Mode-Aware ARM

If a radio is configured as a hybrid AP and that AP is enabled with mode-aware ARM, the hybrid AP can change to an Air Monitor (or *AM*) if too many APs are detected in the area. If the ARM feature changes a hybrid AP to an Air Monitor, that AM does not provide spectrum data after the mode change. The AM unsubscribes from any connected spectrum analysis client, send a log message warning about the change. If mode-aware ARM changes the AM back to an AP, the hybrid AP does not automatically resubscribe back to the spectrum analysis client. The hybrid AP must manually resubscribed before it can appear in the client's [spectrum monitors](#) page.

Creating Spectrum Monitors and Hybrid APs

Each controller can support up to 22 active WebUI connections to spectrum monitor or hybrid AP radios. If you plan on using spectrum monitors or hybrid APs as a permanent overlay to constantly monitor your network, you should create a separate AP group for these devices. If you plan on temporarily converting campus APs to spectrum monitors, best practices are to use the spectrum local override profile to convert an AP to a spectrum monitor.

This section describes the following tasks for converting regular APs into hybrid APs or spectrum monitors.

- ["Converting APs to Hybrid APs " on page 575](#)
- ["Converting an Individual AP to a Spectrum Monitor" on page 575](#)
- ["Converting a Group of APs to Spectrum Monitors" on page 576](#)

Converting APs to Hybrid APs

You can convert a group of regular APs into a hybrid APs by selecting the **spectrum monitoring** option in the AP group's 802.11a and 802.11g radio profiles. Once you have enabled the spectrum monitoring option, all APs in the group that support the spectrum monitoring feature start to function as hybrid APs. If any AP in the group does *not* support the spectrum monitoring feature, that AP continues to function as a standard AP, rather than a hybrid AP.



NOTE: The spectrum monitoring option in the 802.11a and 802.11g radio profiles only affects APs in ap-mode. Devices in am-mode (Air Monitors) or sm-mode (Spectrum Monitors) are not affected by enabling or disabling this option.

If you want to convert a individual AP (and not an entire AP group) to a hybrid AP, you must create a new 802.11a or 802.11g radio profile, enable the **spectrum monitoring** option, then reassign that AP to the new profile. For additional information see ["Working with Mesh High Throughput SSID Profiles" on page 455](#) for details on how to create a new 802.11a/g radio profile, then assign an individual AP to that profile.



NOTE: If the spectrum local-override profile on the controller that terminates the AP contains an entry for a hybrid AP radio, that entry overrides the mode selection in the 802.11a or 802.11g radio profile, and the AP operates as a spectrum monitor, *not* as a hybrid AP. You must remove any spectrum local override for an AP to allow the device to operate as a hybrid AP. For further details on editing a spectrum local override, see ["Converting an Individual AP to a Spectrum Monitor" on page 575](#).

In the WebUI

Follow the procedure below to convert a group of APs to hybrid mode via the WebUI.

1. Navigate to the **Configuration > Wireless > AP Configuration** window. Select the **AP Group** tab.
2. Click the **Edit** button by the name of the AP group you want to convert to hybrid APs.
3. Under the Profiles list, expand the **RF Management** menu.
4. To enable a spectrum monitor on the 802.11a radio band, select the **802.11a radio profile** menu.
-or-
To enable a spectrum monitor on the 802.11g radio band, select the **802.11g radio profile** menu.
5. The **Profile Details** pane appears. Select the **Spectrum Monitor** checkbox.
6. Click **Apply** to save your settings.

In the CLI

To convert a group of APs via the command-line interface, access the CLI in config mode and issue the following commands, where *<profile>* is the name of the 802.11a or 802.11g radio profile used by the group of APs you want to convert to hybrid APs.

```
rf dot11a-radio-profile <profile> spectrum-monitoring
rf dot11g-radio-profile <profile> spectrum-monitoring
```

Converting an Individual AP to a Spectrum Monitor

There are two ways to change a radio on an individual AP or AM into a spectrum monitor. You can assign that AP to a different 802.11a and 802.11g radio profile that is already set to spectrum mode, or you can temporarily change the AP into a spectrum monitor using a local spectrum override profile. When you use a local spectrum override profile to override an AP's mode setting, that AP begins to operate as a spectrum monitor, but remains associated with its previous 802.11a and 802.11g radio profiles. If you change any parameter (other than the overridden *mode* parameter) in the spectrum monitor's 802.11a or 802.11g radio profiles, the spectrum monitor immediately updates with the change. When you remove the local spectrum override, the spectrum monitor reverts back to its previous mode, and remains assigned to the same 802.11a and 802.11g radio profiles as before.

The spectrum local override profile overrides the **mode** parameter in the 802.11a or 802.11g radio profile, changing it from ap-mode or am-mode to **spectrum-mode** while allowing the spectrum monitor to continue to inherit all other settings from its 802.11a/802.11g radio profiles. When the spectrum local override is removed, the AP automatically reverts to its previous mode as defined in its 802.11a or 802.11g radio profile settings. If you use the local override profile to change an AP radio to a spectrum monitor, you must do so by accessing the WebUI or CLI of the controller that terminates the AP. This is usually a local controller, and not a master controller.

In the WebUI

To convert an individual AP using the local spectrum override profile in the WebUI:

1. Select **Configuration > All Profiles**. The **All Profile Management** window opens.
2. Select **AP** to expand the AP profiles section.
3. Select **Spectrum Local Override Profile**. The **Profile Details** pane displays the current **Override Entry** settings.
4. In the **AP name** entry blank, enter the name of an AP whose radio you want to configure as a spectrum monitor. Note that AP names are case-sensitive. Any extra spaces before or after the AP name prevents the AP from being correctly added to the override list.
5. If your AP has multiple radios or a single dual-band radio, click the band drop-down list and select the spectrum band you want that radio to monitor: **2-ghz** or **5-ghz**. Click **Add** to add that radio to the **Override Entry** list.
6. (Optional) Repeat steps 4-6 to convert other AP radios to spectrum monitors, as desired. To remove a spectrum monitor from the override entry list, select that radio name in the override entry list, then click **Delete**.
7. Click **Apply** to save your changes.

In the CLI

To convert an individual AP spectrum monitor using the spectrum local override profile in the command-line interface, access the CLI in config mode and issue the following command:

```
ap spectrum local-override override ap-name <ap-name> spectrum-band 2ghz|5ghz
```

Converting a Group of APs to Spectrum Monitors

When you convert a group of APs to spectrum monitors using their 802.11a/802.11g radio profiles, all AP radios associated with that profile stop serving clients and act as spectrum monitors only. Therefore, before you convert an entire group of APs to spectrum monitors, be sure that none of the APs are currently serving clients, as that may temporarily interrupt service to those clients.

NOTE: If you use an 802.11a or 802.11g radio profile to create a group of spectrum monitors, all APs in any AP group referencing that radio profile are set to spectrum mode. Therefore, best practices are to create a new 802.11a or 802.11g radio profile just for spectrum monitors using the following CLI commands:

```
ap-name <ap name> dot11a-radio-profile <profile-name> ap-name <ap name> dot11g-radio-profile <profile-name>
```

If you want to set an existing 802.11a or 802.11g radio profile to spectrum mode, verify that no other AP group references that radio profile using the following CLI commands:

```
show references rf dot11a-radio-profile <profile-name> show references rf dot11g-radio-profile <profile-name>
```

In the WebUI

Follow the procedure below to convert a group of APs to Spectrum mode via the WebUI.

1. Navigate to the **Configuration > Wireless > AP Configuration** window. Select the **AP Group** tab.
2. Click the **Edit** button by the name of the AP group you want to convert to spectrum monitors.

3. Under the Profiles list, expand the **RF Management** menu.
4. To enable a spectrum monitor on the 802.11a radio band, select the **802.11a radio profile** menu.
-or-
To enable a spectrum monitor on the 802.11g radio band, select the **802.11g radio profile** menu.
5. The **Profile Details** pane appears. Click the **Mode** drop-down list, and select **spectrum-mode**.
6. Click **Apply** to save your settings.

In the CLI

To convert a group of APs via the command-line interface, access the CLI in config mode and issue the commands

```
rf dot11a-radio-profile <profile> mode spectrum-mode
rf dot11g-radio-profile <profile> mode spectrum-mode
```

where <profile> is the 80211a or 80211g radio profile used by the AP group.

Connecting Spectrum Devices to the Spectrum Analysis Client

A spectrum analysis client is any laptop or desktop computer that can access the controller WebUI and receive streaming data from individual spectrum monitors or hybrid APs. Once you have configured one or more APs to operate a a spectrum monitor or hybrid AP, use the **Spectrum Monitors** window to identify the spectrum devices you want to actively connect the spectrum analysis client. To connect one or more spectrum devices to your client:

1. Navigate to **Monitoring > Spectrum Analysis**.
2. Click the **Spectrum Monitors** tab.
3. Click the **Add** button. A table appears, displaying a list of spectrum analysis devices, sorted by name. Single-radio spectrum devices have a single entry in this table, and dual-radio spectrum devices have two entries; one for each radio. This table displays the following data for each radio.

Table 195: Spectrum Device Selection Information



Table Column	Description
AP	Name of the AP whose radio you want to convert to a spectrum monitor. AP names are case sensitive. This column includes the following icons:  Radio is operating as a spectrum monitor.  Radio is operating as a hybrid AP with spectrum enabled.
Band	The frequency band currently used by the radio. This value can be either 2.4 GHz or 5 GHz .
Model	AP model type.
AP Group	Name of the AP group to which the spectrum monitor is currently associated.
Mode	This column indicates the type of spectrum analysis device: <ul style="list-style-type: none"> ● Spectrum Monitor: AP is in spectrum monitor mode. ● Access Point: AP is configured as an access point but with spectrum monitoring enabled (Hybrid AP).
Availability for Connection	Indicates if the AP is available to send spectrum analysis data to the client. Possible options are as follows: <ul style="list-style-type: none"> ● Available, 2.4GHz: The radio is available to send spectrum analysis data on the 2.4GHz frequency band.

Table Column	Description
	<ul style="list-style-type: none"> ● Available, 5GHz: The radio is available to send spectrum analysis data on the 5GHz frequency band. ● Available, Dual Band: The radio is available and is capable of sending spectrum analysis data on either the 2.4 GHz or the 5 GHz frequency bands. ● Available, current channel - <channel>: The AP radio is in hybrid mode and can display spectrum analysis data for the single specified channel only. ● Not available: An AP may not be available because it is currently sending spectrum analysis data to another client.

4. Click the table entry for a spectrum monitor radio, then click **Connect**.
5. Repeat steps 3-4 to connect additional devices, if desired.

View Connected Spectrum Analysis Devices

Once you have connected one or more spectrum monitors or hybrid APs to your Spectrum Analysis client, the **Monitoring > Spectrum Analysis > Spectrum Monitors** window displays a table of currently connected spectrum devices. This table includes the name of each spectrum monitor or hybrid AP and its current radio band (2GHz or 5GHz).

Figure 196: Viewing a list of Connected Spectrum Monitors

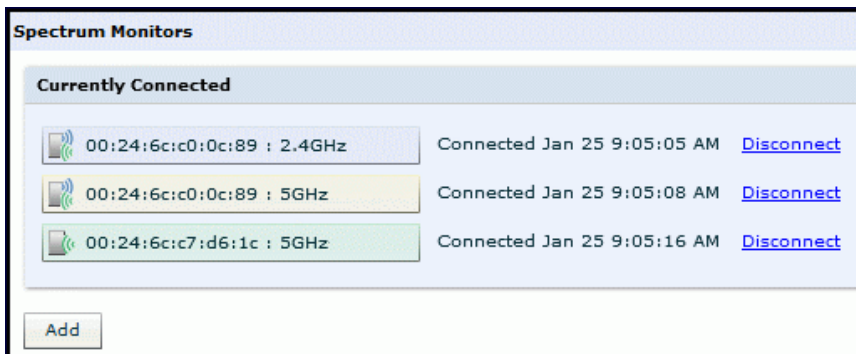

To view a list of connected spectrum devices via the command-line interface, issue the **show ap spectrum monitors** command.

```
(host)# show ap spectrum monitors
List of Sensors
-----
AP name  Group  AP Type  Phy  Band      Channel  Mode              Client IP
Subscribe Time
-----
AP12     default  105     G    2GHz     -        Spectrum Monitor  10.4.165.227
2011-04-25 02:53:52 AM
AP16     default  135     A    5GHz     149     Access Point      10.4.165.227
2011-04-25 02:53:55 AM
AP44     default  105     G    2GHz     -        Spectrum Monitor  10.4.165.227
2011-04-25 02:54:03 AM
```

Disconnecting a Spectrum Device

A spectrum monitor or hybrid AP can send spectrum analysis data to only one client at a time. When you are done viewing data for a spectrum device, you should release your client's subscription to that spectrum device and allow other clients to view data from that device. A spectrum monitor or hybrid AP automatically disconnects from your client when you close the browser window you used to connect the spectrum device your client.

To manually disconnect a spectrum monitor or hybrid AP:

1. Click the **Spectrum Monitors** tab.

2. Each table entry in the **Currently Connected** table includes a **Disconnect** link to release the client's connection to that spectrum monitor. Identify the table entry for the spectrum monitor you want to release then click **Disconnect**.
3. A popup window asks you to confirm that you want to disconnect the spectrum monitor from the spectrum analysis client. Click **OK**. The spectrum monitor disconnects from the client and the device's entry is removed from the **Currently Connected** table.

When you disconnect a spectrum device from your client, the AP continues to operate as a spectrum monitor or hybrid AP until you return the device to AP mode by removing the local spectrum override, or by changing the mode parameter in the AP's 802.11a or 802.11g radio profile from spectrum-mode to AP-mode

 NOTE: If you are using Internet Explorer with multiple instances of the Internet Explorer browser open, and you close the spectrum browser window without manually disconnecting the spectrum device, the controller does not release the data streaming connection to a spectrum monitor until 60 seconds after you close the spectrum client browser window. During this 60-second period, the spectrum monitor is still connected to the client.

Configuring the Spectrum Analysis Dashboards

Once you have connected spectrum monitors to your spectrum analysis client, you can begin to monitor spectrum data in the spectrum analysis dashboards. There are three predefined sets of dashboard views, *View 1*, *View 2* and *View 3*. By default, View 1 displays the Real-Time FFT, FFT Duty-Cycle and Swept Spectrogram graphs, and Views 2 and 3 display the Swept Spectrogram and Quality Spectrogram charts, and the Channel Summary and Active Devices tables.

Each chart in the dashboard can be replaced with other chart types, or reconfigured to show data for a different spectrum monitor. Once you have configured a dashboard view with different settings, you can rename that dashboard view to better reflect its new content.

The following sections explain how to customize your Spectrum Analysis dashboard to best suit the needs of your individual network.

- ["Selecting a Spectrum Monitor" on page 579](#)
- ["Changing Graphs within a Spectrum View" on page 580](#)
- ["Renaming a Spectrum Analysis Dashboard View" on page 581](#)
- ["Saving a Dashboard View" on page 581](#)
- ["Resizing an Individual Graph" on page 582](#)

Selecting a Spectrum Monitor

When you first log into the Spectrum Analysis dashboard, it displays blank charts. You must identify the spectrum monitor whose information you want to view before the graphs display any data.

To identify the spectrum monitor radio whose data you want to appear in the Spectrum Analysis dashboard:

1. Access the **Monitoring > Spectrum Analysis** window in the WebUI.
2. Click the **Spectrum Dashboards** tab.
3. In the graph title bar, click the down arrow by the **Please select a spectrum monitor** heading, as shown in [Figure 197](#). A drop-down list appears with the name of all spectrum monitor and hybrid AP radios currently connected to the client.

Figure 197: Selecting a Spectrum Monitor

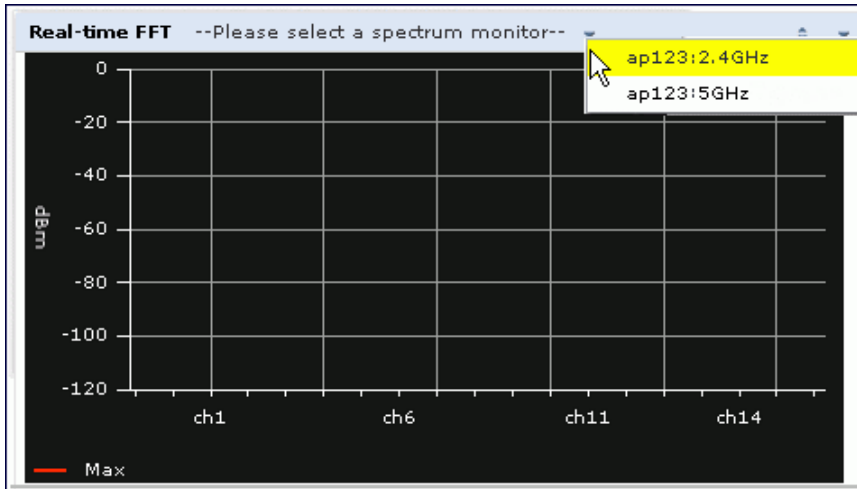

4. Select a spectrum monitor from the list. The spectrum monitor or hybrid AP name appears in the chart titlebar and the chart starts displaying data for that spectrum monitor.

After you have selected the initial spectrum monitor or hybrid AP for a graph, you can display data for a different spectrum device at any time by clicking the down arrow by the device name in the chart titlebar and selecting a different connected spectrum monitor or hybrid AP.

Changing Graphs within a Spectrum View

To replace an existing graph with any other type of graph or chart:

1. Access the **Monitoring > Spectrum Analysis** window in the WebUI.
2. Click the **Spectrum Dashboards** tab.
3. From **Spectrum Dashboards** window, click one of the view names at the top of the window to select the dashboard layout with the graph you want to change.
4. Click the down arrow at the far right end of the graph title bar to display a drop-down menu of chart options.
5. Click **Replace With** to display a list of available graphs.
6. Click the name of the new graph you want to display.

Figure 198: Replacing a Graph in the Spectrum Analysis Dashboard

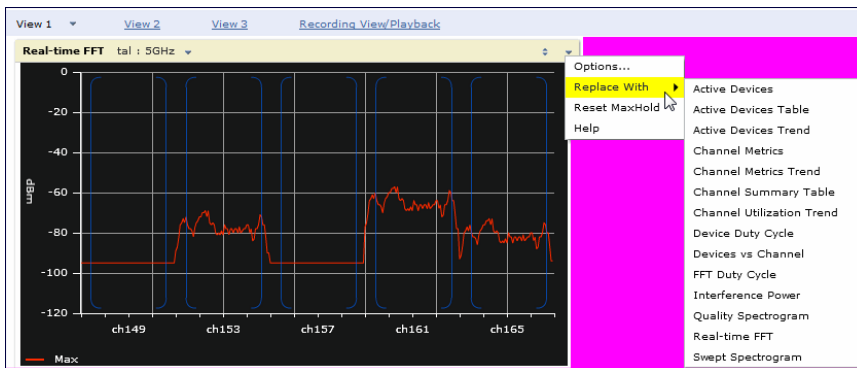

Renaming a Spectrum Analysis Dashboard View

You can rename any of the three spectrum analysis dashboard views at any time. Note, however, that simply renaming a view does not save its settings. (For details on saving a spectrum dashboard view, refer to ["Saving a Dashboard View" on page 581.](#))

To rename a Spectrum Analysis Dashboard view:

1. From the **Monitoring>Spectrum Analysis>Spectrum Dashboards** window, click the down arrow to the right of the dashboard view you want to rename.
2. Select **Rename**.

Figure 199: *Renaming a Spectrum Dashboard View*

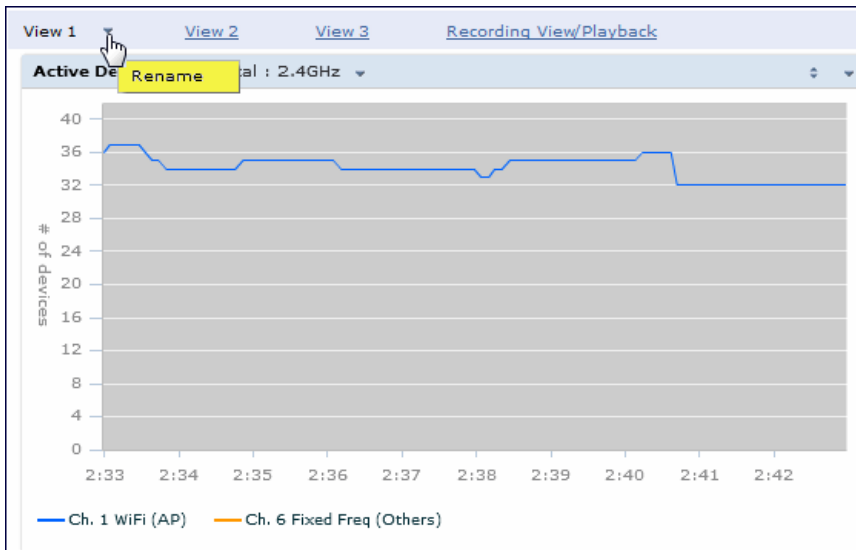

3. The **Dashboard Name** popup window appears. Enter a new name for the dashboard view, then click **OK**.

Saving a Dashboard View

You can select different graphs to display in a dashboard view, but these changes are not saved unless you save that view. Dashboard views, (like the spectrum analysis profile and spectrum local-override profile) are all local configurations that must be configured on each controller. None of these settings are synchronized between Dell controllers.

To save a dashboard view:

1. After selecting the graphs you want to appear in the view, click the **Save Spectrum View** button at the top of the window.

Figure 200: Save a Spectrum Analysis Dashboard Layout

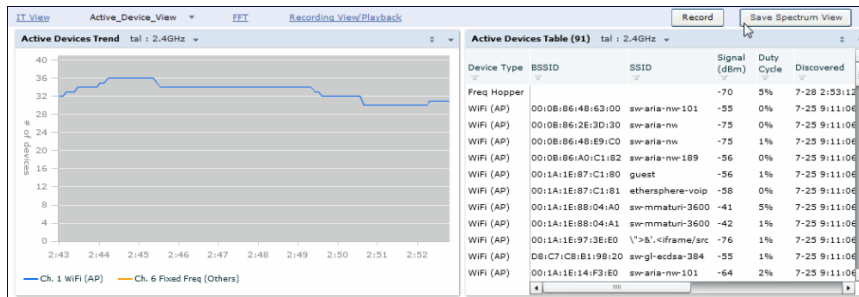

2. The **Spectrum View Saved** confirmation window appears when the spectrum view has been saved. The selected graphs now appear by default whenever you log in to view the spectrum dashboard.



NOTE: If you change graphs in a spectrum view but do not save your settings, you are prompted to save or cancel your changes when you close the spectrum dashboard browser window

Resizing an Individual Graph

The left side of the title bar for each graph includes a resizing button on that allows you to expand a graph for easier viewing. Click this button as shown in [Figure 201](#) to expand the selected graph to the size of the full window and display the **Options** pane, which allows you to change the current display options for that graph. (Configuration options are described in "[Spectrum Analysis Graph Configuration Options](#)" on page 583). To close the options pane if you have not made any changes to the graph, click **Close** at the bottom of the **Options** pane or click the resize button again to return the graph to its original size. To save any changes to the graph, click **OK** to save your settings and close the **Options** pane.

Figure 201: Resizing a Spectrum Analysis Graph

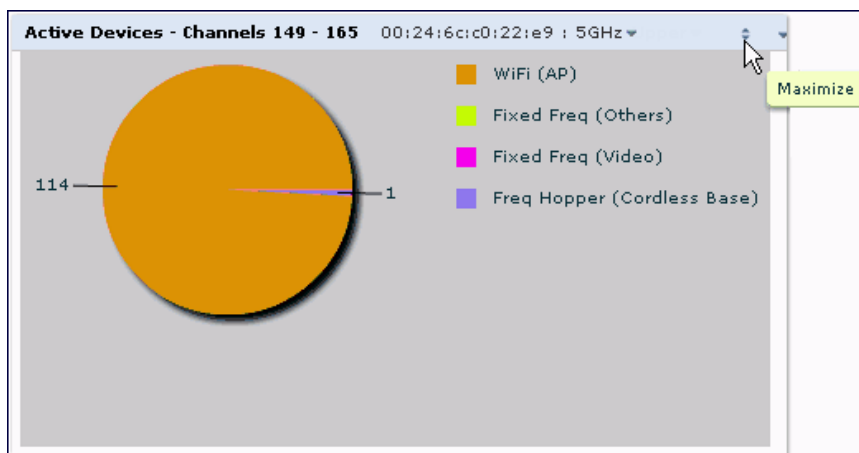

Customizing Spectrum Analysis Graphs

Each Spectrum Analysis graph can be customized to display or hide selected data types. To view the available options for a graph type:

1. From the **Monitoring>Spectrum Analysis>Spectrum Dashboards** window, click the down arrow at the end of the title bar for the graph you want to configure.
2. Select **Options**. The **Options** window appears to the right of the graph.

Figure 202: Viewing Spectrum Analysis Graph Options

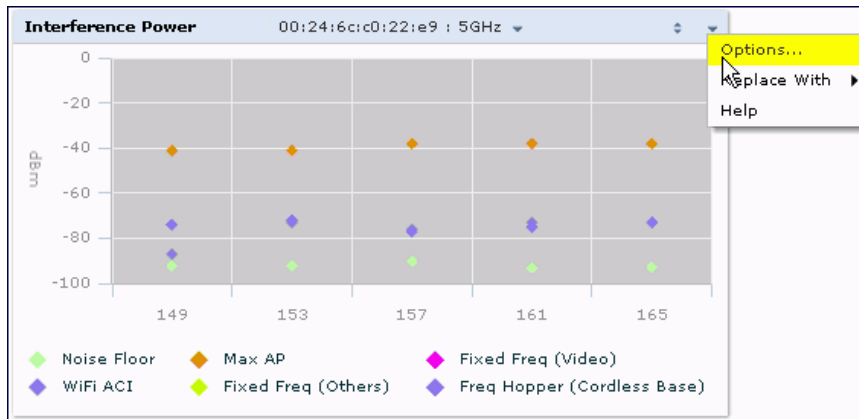

3. From the **Options** window, configure graph settings described in "[Spectrum Analysis Graph Configuration Options](#)" on page 583.
4. When you are done, click **OK** at the bottom of the **Options** window to hide the options window.
5. (Optional) Click **Save Spectrum View** at the top of the window to save your new settings.

Spectrum Analysis Graph Configuration Options

The following sections describe the customizable parameters and the default settings for each spectrum analysis graph.

Active Devices

This graph appears as a pie chart showing the percentages and total numbers of each device type for all active devices seen by the spectrum monitor or hybrid AP radio. This chart is useful for determining which types of devices are sending signals on the specified radio band or channel. The Active Devices graphs for spectrum monitors can be configured to show data for several different device types on a single radio channel or range of channels. Active Devices graphs for hybrid APs can show data for the single monitored channel only.

When you hover your mouse over any section of the pie chart, a tooltip displays the percentage and number of active devices classified into that device type. The example in [Figure 203](#) shows that 99% of the active devices a spectrum monitor radio sees in the 2.4 GHz band are Wi-Fi APs.

Figure 203: Active Devices Graph

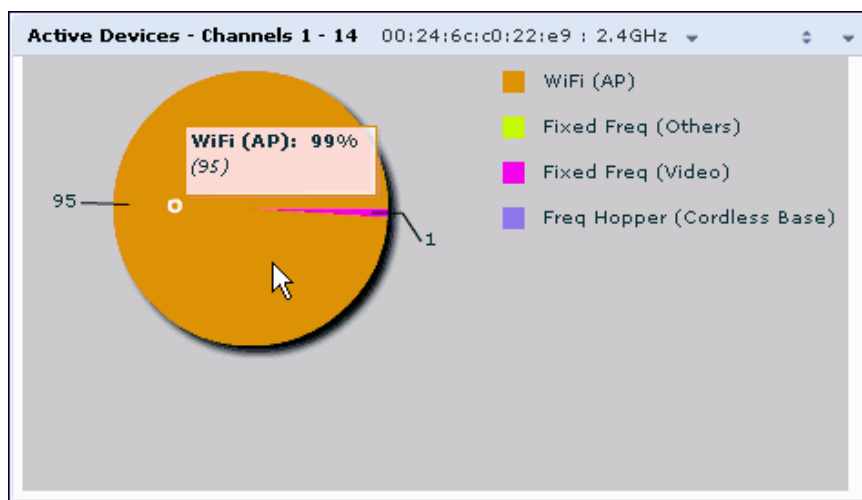

Click the down arrow in the upper right corner of this chart then click the **Options** menu to access the configuration settings for the Active Devices graph. Once you have configured the desired parameters, click **OK** at the bottom of the **Options** menu to save your settings and return to the spectrum dashboards.

Table 204: Active Devices Graph Options

Parameter	Description
Band	Radio band displayed in this graph (2.4 GHz or 5 GHz)
Channel numbering	This parameter is not configurable for graphs created by hybrid APs or spectrum monitor radios that use the 2.4 GHz radio band. A hybrid AP on a 20 MHz channel sees 40 MHz Wi-Fi data as non-Wi-Fi data. For spectrum monitors using the 5 GHz radio band, select either 20 MHz or 40 MHz channel numbering to identify a channel numbering scheme for the graph.
Channel Range	For graphs created by spectrum monitors, specify a channel range to determine which channels appears in this graph. Click the first drop-down list to select the lowest channel in the range, then click the second drop-down list to select the highest channel to appear in the graph. By default, this graph displays all channels within the spectrum monitor's radio band. NOTE: This parameter is not configurable for graphs created by hybrid APs.
Show	Click the checkbox by any of these device categories to include that device type in the graph. <ul style="list-style-type: none"> ● WiFi (AP) ● Microwave <i>(This option is only available for 2.4 GHz radios)</i> ● Bluetooth <i>(This option is only available for 2.4 GHz radios)</i> ● Fixed Freq (Others) ● Fixed Freq (Cordless Phones) ● Fixed Freq (Video) ● Fixed Freq (Audio) ● Freq Hopper (Others) ● Freq Hopper (Cordless Network) ● Freq Hopper (Cordless Base) ● Freq Hopper Xbox <i>(This option is only available for 2.4 GHz radios)</i> ● Microwave (Inverter) <i>(This option is only available for 2.4 GHz radios)</i> ● Generic Interferer NOTE: For more information on non-Wi-Fi device types detected by a spectrum monitor, see "Working with Non-Wi-Fi Interferers" on page 606.

Active Devices Table

This table lets you view, sort, and search for data about the devices that are sending signals on the specified radio band or channel. The Active Devices table for a spectrum monitor displays data for all channels on the selected band. The Active Devices table for a hybrid monitor displays data for the single monitored channel only. Click any of the column headings to sort the information in the table by that column criteria. Make a column wider or narrower by clicking the border of a column heading and dragging the border to a new position.

Figure 205: Active Devices Table

Device Type	BSSID	SSID	Signal (dBm)	Duty Cycle	Discovered	Activity Duration	Channels Affected	Device ID	Center Freq. (MHz)	Occupied bandwidth
WiFi (AP)	0:1a:1e:85:50:c	aruba-ap	-28	0%	1-30 2:49:21 AM	0s	9-13	23	2,462.000	20
WiFi (AP)	0:1a:1e:85:50:c	qa-abaker..	-35	0%	1-30 2:49:21 AM	0s	9-13	24	2,462.000	20
WiFi (AP)	0:1a:1e:50:f:50	aruba-ap	-60	0%	1-30 2:49:21 AM	0s	9-13	145	2,462.000	20
WiFi (AP)	0:1a:1e:64:12:f	ethersphere	-66	0%	1-30 2:53:10 AM	0s	4-8	904	2,437.000	20

You can save the data in the Active Devices table for later analysis by exporting it as data file in .csv format, which can be viewed by spreadsheet and database management applications like Microsoft Excel. To export this table, click the down arrow in the upper right corner of this chart and select **Export**. A window opens and lets you browse to the location to which you want to save the file. Once you have identified the location where you want to save the file, click **Save**.

You can also filter table entries by signal strength, duty cycle, discovery time, activity duration, channels affected and device ID number by clicking the icon below any column heading and specifying the values or value ranges that should appear in the table. [Table 206](#) describes each of the columns in the table and the filters that can be applied to the table output.

Table 206: Active Devices Table Options

Parameter	Description
Device Type	<p>This column shows the type of active device detected by the spectrum monitor or hybrid AP. This column may display any of the following values:</p> <ul style="list-style-type: none"> ● WiFi (AP) ● Microwave (This option is only available for 2.4 GHz radios) ● Bluetooth (This option is only available for 2.4 GHz radios) ● Fixed Freq (Others) ● Fixed Freq (Cordless Phones) ● Fixed Freq (Video) ● Fixed Freq (Audio) ● Freq Hopper (Others) ● Freq Hopper (Cordless Network) ● Freq Hopper (Cordless Base) ● Freq Hopper Xbox (This option is only available for 2.4 GHz radios) ● Microwave (Inverter) (This option is only available for 2.4 GHz radios) ● Generic Interferer <p>NOTE: For more information on non-Wi-Fi device types detected by a spectrum monitor, see "Working with Non-Wi-Fi Interferers" on page 606.</p>
BSSID	The Basic Service Set Identifier of the device. An AP's BSSID is usually its MAC address.
SSID	The service set identifier of the device's 802.11 wireless LAN.
Signal (dBm)	<p>The current transmission power for this device, in dBm.</p> <p>To filter the output of this table to show only specific device types, click the icon in the column</p>

Parameter	Description
	<p>heading then select one of the following options:</p> <ul style="list-style-type: none"> • Select Any to display entries for all signal strength levels. • To display entries within a specific range of power strength levels, enter the minimum signal strength level in the Min field and enter the maximum signal strength level in the Max field. Click OK to save your settings and return to the Active Devices table.
Duty Cycle	<p>The device's duty cycle; the percentage of time that the device is actively sending a signal on the radio band or channel.</p> <p>To filter the output of this table to show only specific duty cycle values or a range of values types, click the icon in the column heading then select one of the following options:</p> <ul style="list-style-type: none"> • Select Any to display all entries, regardless of duty cycle value. • To display entries within a specific range of duty cycles, enter the minimum duty cycle percentage in the Min field and enter the maximum duty cycle percentage in the Max field. Click OK to save your settings and return to the Active Devices table.
Discovered	<p>The time at which the device was first discovered by the spectrum monitor or hybrid AP.</p> <p>To filter the output of this table to show devices discovered within a specific time, click the icon in the column heading.</p> <p>Select Any to display all entries, regardless of when the device was discovered.</p> <p>To display entries for devices discovered within a specific time range:</p> <ol style="list-style-type: none"> 1. Select the button by the Less than drop down list. 2. Click the Less than drop-down list and select either Less than or More than to limit the output of this table to devices discovered earlier or after a specified number of hours or minutes. 3. Enter the number of hours or minutes in the time range you want apply to this filter. 4. Click the min. drop down list and select either min. or hrs. to define the time range in minutes or hours. 5. Click OK to save your settings and return to the Active Devices Table.
Activity Duration	<p>Amount of time that the device has been active.</p> <p>To filter the output of this table to show devices that have been active within a specific time range, click the icon in the column heading.</p> <p>Select Any to display all entries, regardless of how long the device has been active.</p> <p>To display entries for devices active for a specific time range:</p> <ol style="list-style-type: none"> 1. Select the button by the > symbol. 2. Click drop-down list with the > symbol and select either > (Greater than), < (Less than), <= (less than or equal to), or >= (more than or equal to) to limit the output of this table to devices that have been active for a specified time range. 3. Enter the number of hours or minutes in the time range you want apply to this filter. 4. Click the min. drop down list and select either min. or hrs. to define the time range in minutes or hours. 5. Click OK to save your settings and return to the Active Devices Table.
Channels Affected	<p>Radio channels affected by the device's transmission. By default, the Active Devices table for a spectrum monitor shows entries for all devices, regardless of the channels their transmissions may affect.</p> <p>To filter the output of this table to show devices that affect a specific channel or range of channels, click the icon in the column heading.</p> <ul style="list-style-type: none"> • Select Any to display all entries, regardless of the channels that device may affect. • Select Single Channel then enter the channel value to only display devices that affect the specified channel. • Select Range of Channels then enter the lower and upper channels in the channel range to filter the output to show only those devices whose transmissions affect the specified channel range. This option is only available for tables created by spectrum monitors, not hybrid APs. • Select Specified Channels to show only those devices whose transmissions affect selected channels. If you choose this option, you can click the none checkbox to show only those devices whose transmissions do not affect any other channels, select all to show devices

Parameter	Description
	<p>whose transmissions affect any channel, or click the checkboxes by individual channel numbers to show only those devices whose output affect those selected channels. This option is only available for tables created by spectrum monitors, not hybrid APs.</p> <ul style="list-style-type: none"> Click OK to save your settings and return to the Active Devices table. <p>NOTE: This option is not available for Active Devices tables created by a hybrid AP, because each hybrid AP monitors a single channel only.</p>
Device ID	<p>The spectrum monitor or hybrid AP applies a unique device ID per device type to each device it detects on the radio channel.</p> <p>To display the entry for a device that matches a single device ID, click the icon in the column heading and enter the device ID. Click OK to save your settings and return to the Active Devices table.</p>
Center Frequency (MHz)	<p>Signals from a wireless device can spread beyond the boundaries of an individual 802.11 channel. This table column shows the center frequency for the device's transmission, in megahertz.</p>
Occupied Bandwidth	<p>Channel bandwidth used by the device, in megahertz.</p>

Active Devices Trend

The Active Devices Trend chart is a line chart that shows the numbers of Wi-Fi and non-Wi-Fi devices seen on each radio channel during the displayed time interval. When you hover your mouse over any line in the chart, a tooltip displays the number of active devices for the selected device type. The example in [Figure 207](#) shows that there are 27 active Wi-Fi APs on channel 157 of the 5 GHz radio band.

Figure 207: Active Devices Trend Graph

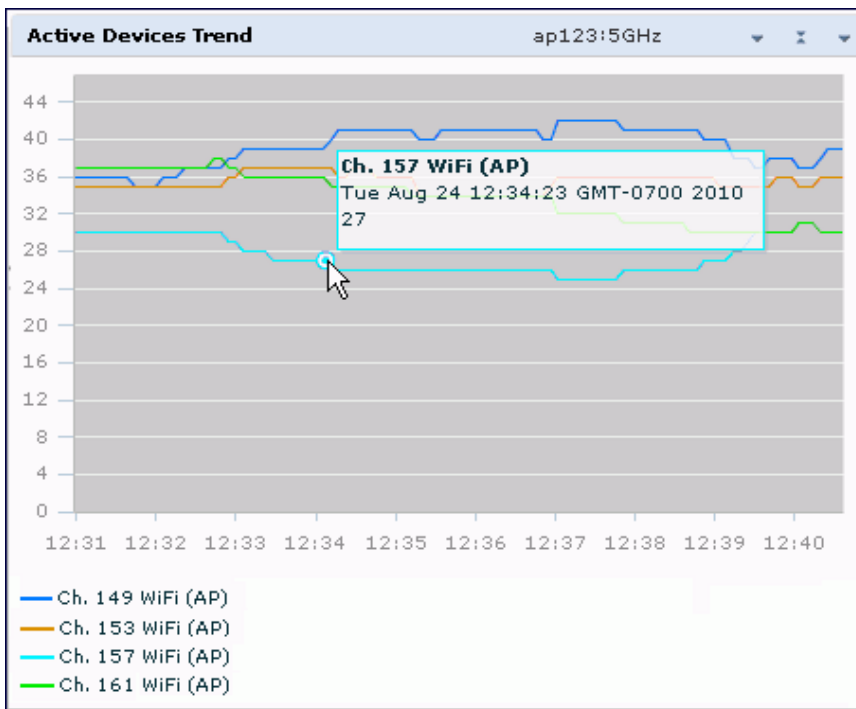

An Active Devices Trend chart created by a hybrid AP displays data for the single channel monitored by that device. For spectrum monitors, the Active Devices Trend chart can display values for up to five different channels and device types. These graphs show the following data by default:

- For SMs on the 2.4 GHz radio band, Wi-Fi APs on channel 1, 6 and 11.

- For SMs on the 5 GHz band, Wi-Fi APs on channel 36, 40 and 44.

Table 208 describes the other values that can be displayed in the Active Devices Trend chart. Click the down arrow in the upper right corner of this chart then click the **Options** menu to access the Active Devices Trend configuration settings. Once you have configured the desired parameters, click **OK** at the bottom of the **Options** menu to save your settings and return to the spectrum dashboards.

Table 208: Active Devices Trend Options

Parameter	Description
Band	Radio band displayed in this graph (2.4 GHz or 5 GHz).
Show Trend for Last	Amount of elapsed time for which this chart should display data.
Channel Numbering	For spectrum monitors using the 5 GHz radio band, select either 20 MHz or 40 MHz channel numbering to identify a channel numbering scheme for the graph. NOTE: This parameter is not configurable for graphs created by hybrid APs or spectrum monitor radios that use the 2.4 GHz radio band. A hybrid AP on a 20 MHz channel sees 40 MHz Wi-Fi data as non-Wi-Fi data.
Show lines for these channels	The Active Devices Trend chart can display values for up to five different device types on different channels for a spectrum monitor, or a single device type for a hybrid AP. To choose which type of data each line should represent, click the channel number drop-down list and select a channel within the radio band, then click the device type drop-down list and select one of the following device types. <ul style="list-style-type: none"> • WiFi (AP) • Microwave (This option is only available for 2.4 GHz radios) • Bluetooth (This option is only available for 2.4 GHz radios) • Fixed Freq (Others) • Fixed Freq (Cordless Phones) • Fixed Freq (Video) • Fixed Freq (Audio) • Freq Hopper (Others) • Freq Hopper (Cordless Network) • Freq Hopper (Cordless Base) • Freq Hopper Xbox (This option is only available for 2.4 GHz radios) • Microwave (Inverter) (This option is only available for 2.4 GHz radios) • Generic Interferer Select the checkbox beside each channel and device entry to show that information on the chart, or unselect the checkbox to hide that information. For more information on non-Wi-Fi device types detected by a spectrum monitor, see " Working with Non-Wi-Fi Interferers " on page 606.

Channel Metrics

This stacked bar chart can show one of three different types of channel metrics; *channel utilization*, *channel availability*, or *channel quality*.

By default, this chart displays channel utilization data, showing both the percentage of each monitored channel that is currently being used by Wi-Fi devices, and the percentage of each channel being used by non-Wi-Fi devices and 802.11 adjacent channel interference (ACI).

NOTE: ACI refers to the interference on a channel created by a transmitter operating in an adjacent channel. A transmitter on a nonadjacent or partially overlapping channel may also cause interference, depending on the transmit power of the interfering transmitter and/or the distance between the devices. In general, ACI may be caused by a Wi-Fi transmitter or a non-Wi-Fi interferer. However, whenever the term ACI appears in Spectrum Analysis graphs, it refers to the ACI caused by Wi-Fi transmitters. The channel utilization option in the Channel Metrics Chart shows the percentage of the channel utilization due to both ACI and non-Wi-



Fi interfering devices. Unlike the ACI shown in the **Interference Power** chart, the ACI shown in this graph indicates the percentage of channel time that is occupied by ACI or unavailable for Wi-Fi communication due to ACI.

The Channel Metrics graph can also show channel availability, the percentage of each channel that is available for use, or display the current relative quality of selected channels in the 2.4 GHz or 5 GHz radio bands. Spectrum monitors can display data for all channels in their selected band. Hybrid APs display data for their one monitored channel only.

In the spectrum analysis feature, channel quality is a relative measure that indicates the ability of the channel to support reliable Wi-Fi communication. Channel quality, which is represented as a percentage in this chart, is a weighted metric derived from key parameters that can affect the communication quality of a wireless channel, including noise, non-Wi-Fi (interferer) utilization and duty-cycles, and certain types of retries. Note that channel quality is not directly related to Wi-Fi channel utilization, as a higher quality channel may or may not be highly utilized.

When you hover your mouse over any bar in the chart, a tooltip displays the metric value for that individual channel. The example below shows that 61% of channel 3 is being consumed by non-Wi-Fi devices and 802.11 adjacent channel interference.

Figure 209: Channel Metrics Graph

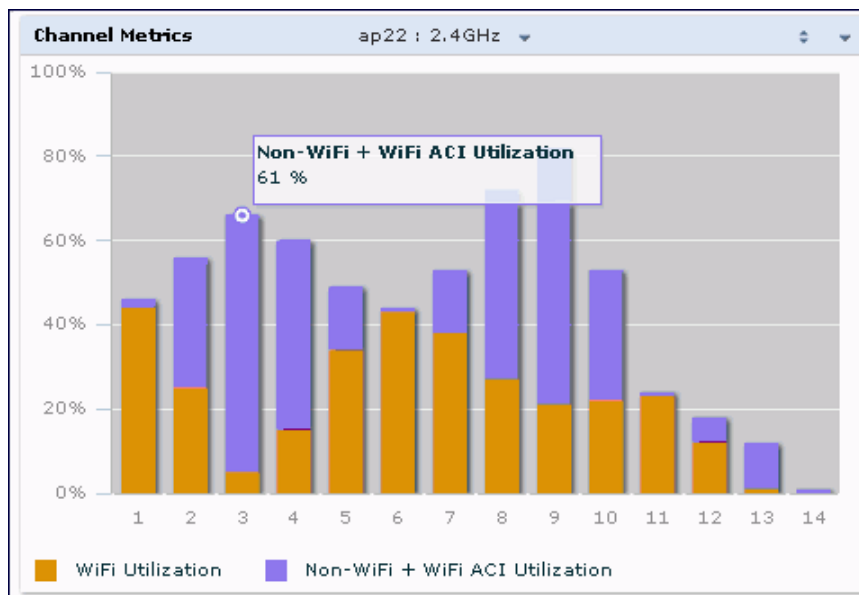

Table 210 describes the parameters that can be displayed in the Channel Metrics graph. Click the down arrow in the upper right corner of this chart then click the **Options** menu to access these configuration settings. Once you have configured the desired parameters, click **OK** at the bottom of the **Options** menu to save your settings and return to the spectrum dashboards.

Table 210: Channel Metrics Options

Parameter	Description
Band	Radio band displayed in this graph. For spectrum monitor radios using the 5 GHz radio band, click the Band drop-down list and select 5 GHz upper , 5GHz middle or 5Ghz lowerto to display data for that portion of the 5 GHz radio band. This parameter is not configurable for graphs created by hybrid APs or spectrum monitor radios that use

Parameter	Description
	the 2.4 GHz radio band.
Channel Numbering	For spectrum monitors using the 5 GHz radio band, select either 20 MHz or 40 MHz channel numbering to identify a channel numbering scheme for the graph. NOTE: This parameter is not configurable for graphs created by hybrid APs or spectrum monitor radios that use the 2.4 GHz radio band. A hybrid AP on a 20 MHz channel sees 40 MHz Wi-Fi data as non-Wi-Fi data.
Channel Range	For graphs created by spectrum monitors, specify a channel range to determine which channels appear in this graph. Click the first drop-down list to select the lowest channel in the range, then click the second drop-down list to select the highest channel to appear in the graph. By default, this graph displays all channels within the spectrum monitor's radio band. NOTE: This parameter is not configurable for graphs created by hybrid APs.
Display Mode	Select Channel Quality to show the relative quality of the channel. Channel Quality is a weighted metric derived from key parameters which include noise, non-Wi-Fi (interferer) utilization and duty-cycles, and certain types of retries. Select Channel Availability to show the percentage of the channel that is unused and available for additional Wi-Fi traffic. Select Channel Utilization to show both the percentage of the channel that is currently utilized by Wi-Fi devices, and the percentage of each channel that is being utilized by non-802.11 devices or 802.11 adjacent channel interference (ACI).

Channel Metrics Trend

By default, this line chart shows the current relative quality of selected channels in the 2.4 GHz or 5 GHz radio bands over a period of time. The Channel Metrics Trend chart can also be configured to display trends for the current availability of selected channels, or the percentage of availability for those channels. Spectrum monitors can display data for up to five different channels. Hybrid APs display data for their one monitored channel only.



NOTE: For more information on how the spectrum analysis feature determines the quality of a channel, see "[Channel Metrics](#)" on page 588.

When you hover your mouse over any line in the chart, a tooltip displays channel quality or availability data for that individual channel at the selected time.

Figure 211: Channel Metrics Trend Chart

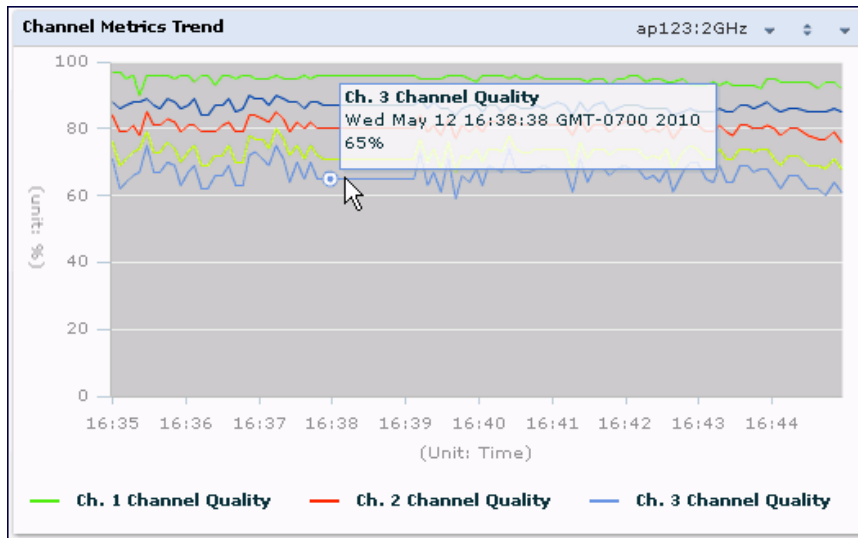

Table 212 describes the other parameters that can be displayed in the Channel Metrics Trend output. Click the down arrow in the upper right corner of this chart then click the **Options** menu to access these configuration settings. Once you have configured the desired parameters, click **OK** at the bottom of the **Options** menu to save your settings and return to the spectrum dashboard.

Table 212: Channel Metrics Trend Options

Parameter	Description
Band	Radio band displayed in this graph (2.4 GHz or 5 GHz).
Show Trend for Last	By default, the Channel Quality Trend chart shows channel quality or channel availability for the past 10 minutes. To view data for a different time range, click the Show Trend for Last drop-down list and select one of the following options: <ul style="list-style-type: none"> ● 10 minutes ● 30 minutes ● 1 hour
Channel numbering	For spectrum monitors using the 5 GHz radio band, select either 20 MHz or 40 MHz channel numbering to identify a channel numbering scheme for the graph. NOTE: This parameter is not configurable for graphs created by hybrid APs or spectrum monitor radios that use the 2.4 GHz radio band. A hybrid AP on a 20 MHz channel sees 40 MHz Wi-Fi data as non-Wi-Fi data.
Show Lines for These Channels	The Channel Quality Trend chart for a spectrum monitor can display channel quality, channel availability or channel utilization values for up to five different channels on the selected radio band. Charts for hybrid APs can display data for the one channel monitored by that hybrid AP radio. To choose which type of data each line should represent on a chart for a spectrum monitor, click the channel number drop-down list and select a channel within the radio band, then click the second drop-down list and select either Channel Quality , or Channel Availability . Select the checkbox beside each channel entry to show that information on the chart, or unselect the checkbox to hide that information.

Channel Summary Table

The channel summary table provides a summarized or aggregated view of key statistics. Spectrum monitors display spectrum analysis data seen on all channels in the selected band, and hybrid APs display data from the one channel they are monitoring. The example in [Figure 213](#) below shows that a spectrum monitor sees 44 Valid APs and 52% channel utilization on channel 40 in the 5GHz radio band.

Figure 213: Channel Summary Table

Channel	Valid APs	Not Valid APs	Non Wi-Fi Devices	Center Freq. (GHz)	Channel Util. (%)	Max AP Power (dBm)	Max Interference (dBm)	SINR (dB)
36	57	2	4	5.180	58	-40	-	40
40	44	2	8	5.200	56	-40	-	40
44	37	2	2	5.220	57	-48	-	48
48	41	2	6	5.240	56	-48	-	48
52	4	3	0	5.260	20	-75	-	75
56	4	3	9	5.280	20	-75	-	75
60	0	1	3	5.300	8	-	-	0
64	0	0	0	5.320	0	-	-	0
100	0	0	0	5.500	0	-	-	0

Spectrum monitor radios using the 5 GHz radio band can display channels using either 20 MHz or 40 MHz channel numbering. To toggle between these two channel numbering modes, click the down arrow in the upper right corner of the graph titlebar then click either **Show 20 MHz Channels** or **Show 40 MHz Channels**.

Click any of the column headings to sort the information in the table by that column criteria. Make a column wider or narrower by clicking the border of a column heading and dragging the border to a new position.

[Table 214](#) describes the output of the Channel Summary table.

Table 214: Channel Summary Table Parameters

Parameter	Description
Channel	Radio channel being monitored by the spectrum monitor or hybrid AP
Valid APs	Number of known APs seen on the network.
Not Valid APs	Number of unknown or invalid APs seen on the network.
Non Wi-Fi Devices	Number of Non-Wi-Fi (interfering) devices detected/classified by the spectrum monitor
Center Freq. (GHz)	Center frequency of the Wi-Fi signals sent on that radio channel.
Channel Util. (%)	Percentage of the channel currently being used by devices on the network
Max AP Power (dBm)	Signal strength of the AP that has the maximum signal strength on a channel.
Max Interference (dBm)	Signal strength of the non-Wi-Fi device that has the highest signal strength.
SNIR (dB)	The Signal-to-Noise-and-Interference Ratio (SNIR) is the ratio of signal strength to the combined levels of interference and noise on that channel. This value is calculated by determining the maximum noise-floor and interference-signal levels, and then calculating how strong the desired signal is above this maximum.

Device Duty Cycle

The Device Duty Cycle Chart is a stacked bar chart that shows the duty cycle of each device type on a channel. The duty cycle is the percentage of time each device type operates or transmits on that channel. Though Wi-Fi devices do not transmit if there is another Wi-Fi or non-Wi-Fi device active at that time, most non-Wi-Fi devices do not follow such a protocol for transmissions. Since these devices operate independently without regard to any other devices operating on the same channel, the total duty cycle of all device types may add up to more than 100% on a channel. For example, one or more video bridges may be active on a channel, each with 100% duty cycle. The same channel may have a cordless transmitter with 10% duty cycle and a microwave oven with 50% duty cycle. In this example, the Device Duty Cycle chart shows all three device types with their respective duty cycle percentages.



NOTE: This chart is not available for W-AP120 Series or W-AP68 access points. A hybrid AP on a 20 MHz channel will see 40 MHz Wi-Fi data as non-Wi-Fi data.

Spectrum monitors display spectrum analysis data seen on all channels in the selected band, and hybrid APs display data from the one channel they are monitoring. The example below shows data from a spectrum monitor monitoring all channels in the 2.4 GHz band.

Figure 215: *Device Duty Cycle*

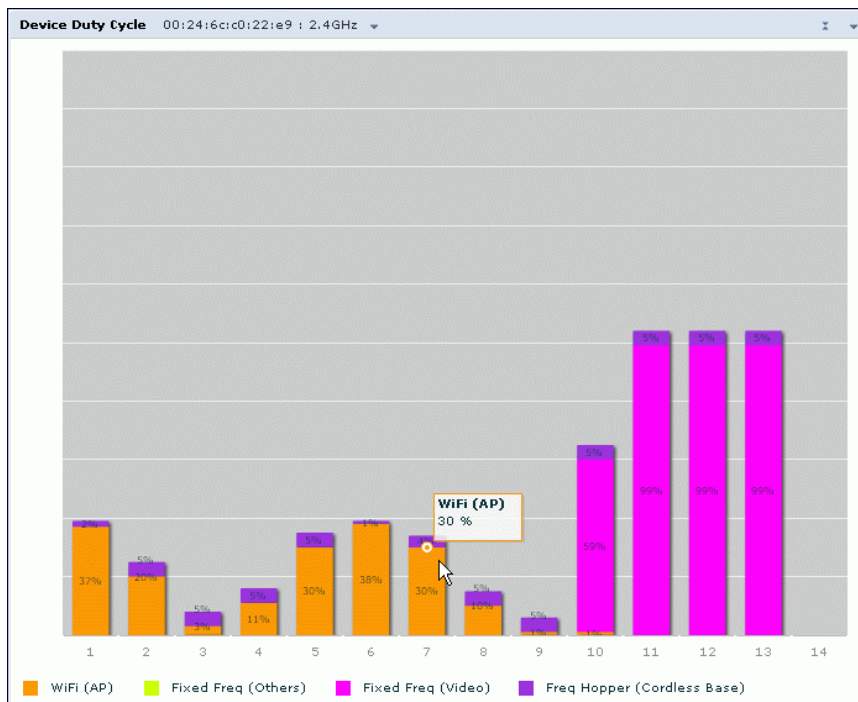

Table 216 describes the parameters you can use to customize the Device Duty Cycle chart. Click the down arrow in the upper right corner of this chart then click the **Options** menu to access these configuration settings. Once you have configured the desired parameters, click **OK** at the bottom of the **Options** menu to save your settings and return to the spectrum dashboards.

Table 216: *Device Duty Cycle Options*

Parameter	Description
Band	Radio band displayed in this graph.

Parameter	Description
	For spectrum monitor radios using the 5 GHz radio band, click the Band drop-down list and select 5 GHz upper , 5GHz middle or 5GHz lower to display data for that portion of the 5 GHz radio band. This parameter is not configurable for graphs created by hybrid APs or spectrum monitor radios that use the 2.4 GHz radio band.
Channel Numbering	For spectrum monitors using the 5 GHz radio band, select either 20 MHz or 40 MHz channel numbering to identify a channel numbering scheme for the graph. NOTE: This parameter is not configurable for graphs created by hybrid APs or spectrum monitor radios that use the 2.4 GHz radio band. A hybrid AP on a 20 MHz channel sees 40 MHz Wi-Fi data as non-Wi-Fi data.
Channel Range	For graphs created by spectrum monitors, specify a channel range to determine which channels appear in this graph. Click the first drop-down list to select the lowest channel in the range, then click the second drop-down list to select the highest channel to appear in the graph. By default, this graph displays all channels within the spectrum monitor's radio band. NOTE: This parameter is not configurable for graphs created by hybrid APs.
Show	This graph can display values for up to five different device types on different channels for a spectrum monitor, or a single device type for a hybrid AP monitoring a single channel. To choose which type of data each line should represent, click the channel number drop-down list and select a channel within the radio band, then click the device type drop-down list and select one of the following device types <ul style="list-style-type: none"> ● WiFi (AP) ● Microwave <i>(This option is only available for 2.4 GHz radios)</i> ● Bluetooth <i>(This option is only available for 2.4 GHz radios)</i> ● Fixed Freq (Others) ● Fixed Freq (Cordless Phones) ● Fixed Freq (Video) ● Fixed Freq (Audio) ● Freq Hopper (Others) ● Freq Hopper (Cordless Network) ● Freq Hopper (Cordless Base) ● Freq Hopper Xbox <i>(This option is only available for 2.4 GHz radios)</i> ● Microwave (Inverter) <i>(This option is only available for 2.4 GHz radios)</i> ● Generic Interferer NOTE: For more information on non-Wi-Fi device types detected by a spectrum monitor, see "Working with Non-Wi-Fi Interferers" on page 606.

Channel Utilization Trend

The Channel Utilization Trend chart is a line chart that shows the percentage of total utilization on each channel over a time interval. The channel utilization includes the utilization due to Wi-Fi as well as utilization due to non-Wi-Fi interferers and Adjacent Channel Interference (ACI).



NOTE: For additional information on how the spectrum analysis feature measures ACI, see ["Channel Metrics"](#) on page 588.

This graph can show data recorded for the last ten, thirty, or sixty minutes. Spectrum monitors display spectrum analysis data seen on all channels in the selected band, and hybrid APs display data from the one channel they are monitoring. When you hover your mouse over any line in the chart, a tooltip shows the percentage of the channel being utilized at the specified time. The example in [Figure 217](#) shows that channel 1 was 70% utilized at the selected time in the chart.

Figure 217: Channel Utilization Trend

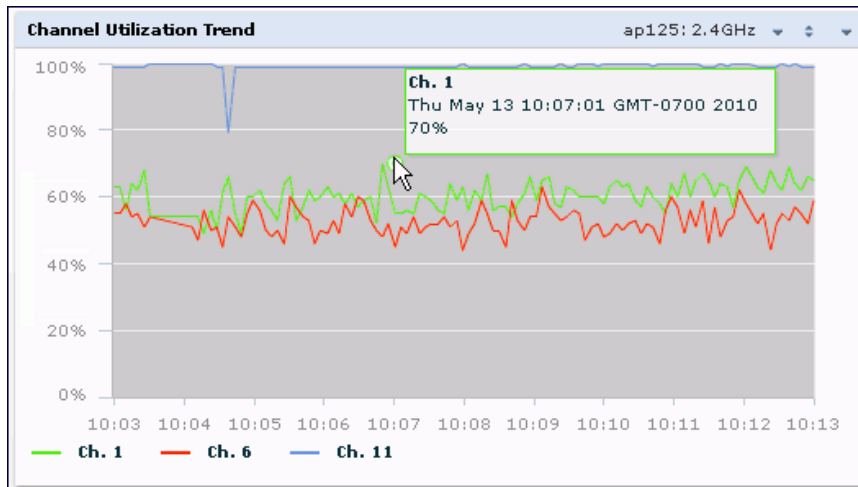

Table 218 describes the parameters you can use to customize the Channel Utilization Trend chart. Click the down arrow in the upper right corner of this chart then click the **Options** menu to access these configuration settings. Once you have configured the desired parameters, click **OK** at the bottom of the **Options** menu to save your settings and return to the spectrum dashboards.

Table 218: Channel Utilization Trend Options

Parameter	Description
Intervals	By default, the Channel Utilization Trend chart shows channel quality or channel availability for the past 10 minutes. To view data for a different time range, click the Intervals drop-down list and select one of the following options: <ul style="list-style-type: none"> ● 10 minutes ● 30 minutes ● 1 hour
Band	Radio band displayed in this graph (2.4 GHz or 5 GHz).
Channel Numbering	For spectrum monitors using the 5 GHz radio band, select either 20 MHz or 40 MHz channel numbering to identify a channel numbering scheme for the graph. NOTE: This parameter is not configurable for graphs created by hybrid APs or spectrum monitor radios that use the 2.4 GHz radio band. A hybrid AP on a 20 MHz channel sees 40 MHz Wi-Fi data as non-Wi-Fi data.
Show	To select individual channels you want to display on this chart, click the checkbox by a channel entry, then click the channel drop-down list to select the channel to display. To hide a channel, uncheck the checkbox by that channel number.

Devices vs Channel

This stacked bar chart shows the current number of devices using each channel in the radio's frequency band. This chart can show separate per-channel statistics for the numbers of Wi-Fi devices, cordless phones, bluetooth devices, microwaves, and other non-Wi-Fi devices.

If a device affects more than one channel, it is recorded as a device on all channels it affects. For example, if a 20Mhz Wi-Fi AP has a center frequency of 2437 Mhz (channel 6) it is counted as a device on channels 3-9 because

it affects all those channels. Similarly, if a channel-hopping device uses all channels within a frequency band, it is counted as a device on all channels in that band.

When you hover the mouse over any part of the chart, a tooltip shows the numbers of the device type currently using that channel. The example in [Figure 219](#) shows that the spectrum monitor can detect 42 APs on channel 5.

Figure 219: Devices vs Channel

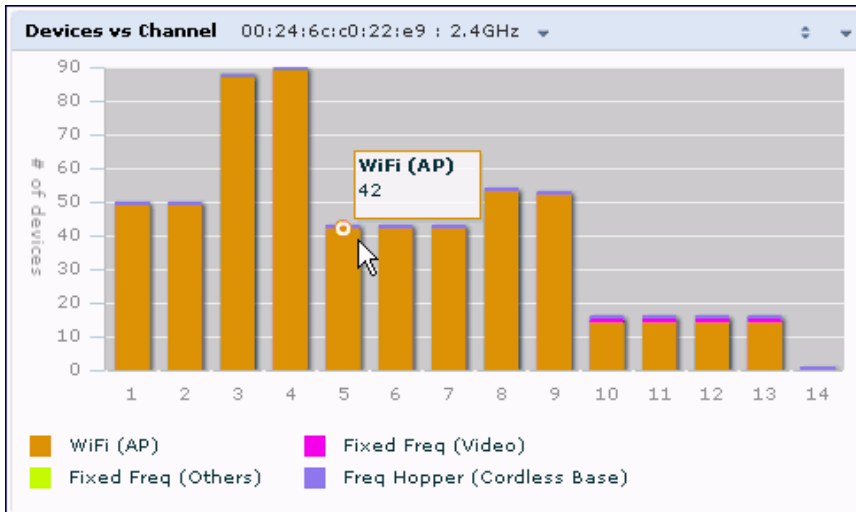

[Table 220](#) describes the parameters you can use to customize the Devices vs Channel chart. Click the down arrow in the upper right corner of this chart then click the **Options** menu to access these configuration settings. Once you have configured the desired parameters, click **OK** at the bottom of the **Options** menu to save your settings and return to the spectrum dashboards.

Table 220: Devices vs Channel Options

Parameter	Description
Band	Radio band displayed in this graph. For spectrum monitor radios using the 5 GHz radio band, click the Band drop-down list and select 5 GHz upper , 5GHz middle or 5Ghz lower to display data for that portion of the 5 GHz radio band. This parameter is not configurable for graphs created by hybrid APs or spectrum monitor radios that use the 2.4 GHz radio band.
Channel Numbering	For spectrum monitors using the 5 GHz radio band, select either 20 MHz or 40 MHz channel numbering to identify a channel numbering scheme for the graph. NOTE: This parameter is not configurable for graphs created by hybrid APs or spectrum monitor radios that use the 2.4 GHz radio band. A hybrid AP on a 20 MHz channel sees 40 MHz Wi-Fi data as non-Wi-Fi data.
Channel Range	For graphs created by spectrum monitors, specify a channel range to determine which channels appear in this graph. Click the first drop-down list to select the lowest channel in the range, then click the second drop-down list to select the highest channel to appear in the graph. By default, this graph displays all channels within the spectrum monitor's radio band. NOTE: This parameter is not configurable for graphs created by hybrid APs.
Show	This graph can show data for up to five different device types. To show how many devices of a specific type are sending a signal on the selected channel range, click the show checkbox by that device, then click the device drop-down list and select one of the following device types.

Parameter	Description
	<ul style="list-style-type: none"> ● WiFi (AP) ● Microwave <i>(This option is only available for 2.4 GHz radios)</i> ● Bluetooth <i>(This option is only available for 2.4 GHz radios)</i> ● Fixed Freq (Others) ● Fixed Freq (Cordless Phones) ● Fixed Freq (Video) ● Fixed Freq (Audio) ● Freq Hopper (Others) ● Freq Hopper (Cordless Network) ● Freq Hopper (Cordless Base) ● Freq Hopper Xbox <i>(This option is only available for 2.4 GHz radios)</i> ● Microwave (Inverter) <i>(This option is only available for 2.4 GHz radios)</i> ● Generic Interferer <p>NOTE: For more information on non-Wi-Fi device types detected by a spectrum monitor, see "Working with Non-Wi-Fi Interferers" on page 606.</p>

FFT Duty Cycle

The FFT Duty Cycle chart is a line chart that shows the duty cycle for each frequency bin. The width of the each frequency bin depends on the resolution bandwidth of the spectrum monitor. The spectrum analysis feature considers a frequency bin to be utilized if the detected power in that bin is at least 20 dB higher than the nominal noise floor on that channel. The FFT Duty Cycle provides a more granular view of the duty cycle per bin as opposed to the aggregated channel utilization reported in the Channel Metrics chart.



NOTE: This chart is not available for W-AP120 Series or W-AP68 access points. A hybrid AP on a 20 MHz channel will see 40 MHz Wi-Fi data as non-Wi-Fi data.

This chart can show the duty cycle over the last second, the maximum FFT duty cycle measured for all samples taken over the last N sweeps, and the greatest FFT duty cycle recorded since the chart was last reset.

Figure 221: FFT Duty Cycle

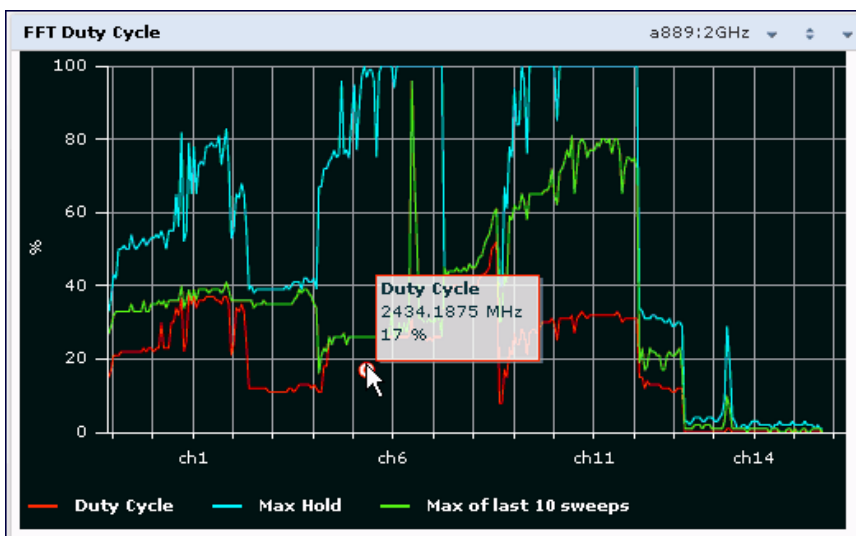

By default, this chart shows the current duty cycle for devices on all channels being monitored by the spectrum monitor radio. [Table 222](#) describes the other optional parameters you can use to customize the FFT Duty Cycle table. Click the down arrow in the upper right corner of this chart then click the **Options** menu to access these

configuration settings. Once you have configured the desired parameters, click **OK** at the bottom of the **Options** menu to save your settings and return to the spectrum dashboards.

Table 222: FFT Duty Cycle Options

Parameter	Description
Band	Radio band displayed in this graph. For spectrum monitor radios using the 5 GHz radio band, click the Band drop-down list and select 5 GHz upper , 5GHz middle or 5Ghz lower to display data for that portion of the 5 GHz radio band. This parameter is not configurable for graphs created by hybrid APs or spectrum monitor radios that use the 2.4 GHz radio band.
Channel Numbering	For spectrum monitors using the 5 GHz radio band, select either 20 MHz or 40 MHz channel numbering to identify a channel numbering scheme for the graph. NOTE: This parameter is not configurable for graphs created by hybrid APs or spectrum monitor radios that use the 2.4 GHz radio band.
X-Axis	Select either Channel or Frequency to show the duty cycle for a range of channels or frequencies.
Channel Range	If you selected Channel in the X-Axis parameter, you must also specify a channel range to determine which channels appear in the x-axis of this chart. Click the first drop-down list to select the lowest channel in the range, then click the second drop-down list to select the highest channel to appear in the chart. NOTE: This parameter is not configurable for graphs created by hybrid APs.
Center Frequency	If you selected Frequency in the X-Axis parameter, enter the frequency, in MHz, that you want to appear in the center of the x-axis of this chart.
Span	If you selected Frequency in the X-Axis parameter, specify the size of the range of frequencies around the selected center frequency. If you set a frequency span of 100 MHz, for example, the chart shows the FFT duty cycle for a range of frequencies from 50MHz lower to 50 MHz higher than the selected center.
Show	Select a checkbox to display that information on the FFT Duty Cycle chart. <ul style="list-style-type: none"> • Duty Cycle: The percentage of duty cycle the channel or frequency was actively utilized. • Max Hold: The maximum recorded percentage of active duty cycles for the channel frequency since the chart was last reset. To clear this setting, click the down arrow at the end of the title bar for this graph and select Reset MaxHold. • Max of last sweeps: By default, this chart shows the maximum percentage of active duty cycles for the channel of frequency recorded during the last 10 sweeps. To change the number of sweeps used to determine this value, enter a number from 2 to 20, inclusive. To clear this setting, click the down arrow at the end of the title bar for this graph and select Reset MaxNSweep.

Interference Power

The Interference Power chart displays various power levels of interest, including the Wi-Fi AP with maximum signal strength, noise, and interferer types with maximum signal strength. The ACI displayed in the Interference Power Chart is the ACI power level based on the signal strength(s) of the Wi-Fi APs on adjacent channels. A higher ACI value in Interference Power Chart does not necessarily mean higher interference since the AP that is contributing to the maximum ACI may or may not be very actively transmitting data to other clients at all times. The ACI power levels are derived from the signal strength of the beacons.

This chart displays the noise floor of each selected channel in dBm. The noise floor of a channel depends on the noise figure of the RF components used in the radio, temperature, presence of certain types of interferers or noise, and the width of the channel. For example, in a clean RF environment, a 20 MHz channel has a noise floor around -

95 dBm and a 40 MHz channel has a noise floor around -92 dBm. Certain types of fixed-frequency continuous transmitters such as video bridges, fixed-frequency phones, and wireless cameras typically elevate the noise floor seen by the spectrum monitor. Other interferers such as frequency-hopping phones, Bluetooth and Xbox may not affect the noise floor of the radio. A Wi-Fi radio can only reliably decode Wi-Fi signals that are a certain dB above the noise floor and therefore estimating and understanding the actual noise floor of the radio is critical to understanding the reliability of the RF environment.

The chart also includes information about the AP on each channel with the highest power level. You can hover your mouse over an AP on the chart to view the AP's name, SSID and current power level. The example below shows that the AP with the maximum power on channel 157 has the SSID **qa-ss**, and a power level of **-55dBm**.

Figure 223: Interference Power

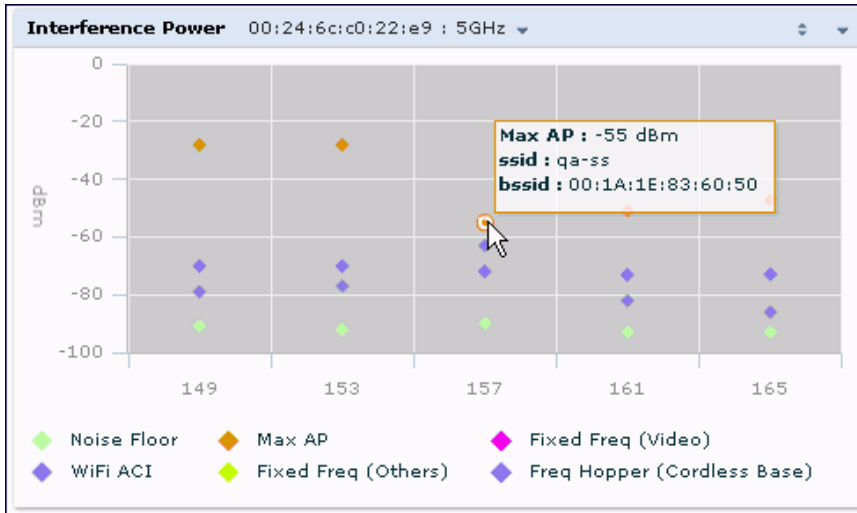

Table 224 describes the other optional parameters you can use to customize the interference power chart. Click the down arrow in the upper right corner of this chart then click the **Options** menu to access these configuration settings. Once you have configured the desired parameters, click **OK** at the bottom of the **Options** menu to save your settings and return to the spectrum dashboards.

Table 224: Interference Power Options

Parameter	Description
Band	Radio band displayed in this graph. For spectrum monitor radios using the 5 GHz radio band, click the Band drop-down list and select 5 GHz upper , 5GHz middle or 5Ghz lower to display data for that portion of the 5 GHz radio band. This parameter is not configurable for graphs created by hybrid APs or spectrum monitor radios that use the 2.4 GHz radio band.
Channel Numbering	For spectrum monitors using the 5 GHz radio band, select either 20 MHz or 40 MHz channel numbering to identify a channel numbering scheme for the graph. NOTE: This parameter is not configurable for graphs created by hybrid APs or spectrum monitor radios that use the 2.4 GHz radio band. A hybrid AP on a 20 MHz channel sees 40 MHz Wi-Fi data as non-Wi-Fi data.
Show	By default, this chart displays data for the current noise floor, adjacent channel interference (ACI), and the maximum AP power level for each channel. To display interference power levels from other devices, click the show checkbox then click the show drop-down list and select one of the following

Parameter	Description
	device types. <ul style="list-style-type: none"> ● Microwave <i>(This option is only available for 2.4 GHz radios)</i> ● Bluetooth <i>(This option is only available for 2.4 GHz radios)</i> ● Fixed Freq (Others) ● Fixed Freq (Cordless Phones) ● Fixed Freq (Video) ● Fixed Freq (Audio) ● Freq Hopper (Others) ● Freq Hopper (Cordless Network) ● Freq Hopper (Cordless Base) ● Freq Hopper Xbox <i>(This option is only available for 2.4 GHz radios)</i> ● Microwave (Inverter) <i>(This option is only available for 2.4 GHz radios)</i> ● Generic Interferer For more information on non-Wi-Fi device types detected by a spectrum monitor, see "Working with Non-Wi-Fi Interferers" on page 606.
Channel Range	For graphs created by spectrum monitors, specify a channel range to determine which channels appear in this graph. Click the first drop-down list to select the lowest channel in the range, then click the second drop-down list to select the highest channel to appear in the graph. By default, this graph displays all channels within the spectrum monitor's radio band. NOTE: This parameter is not configurable for graphs created by hybrid APs.

Quality Spectrogram

This plot shows the channel quality statistics for selected range of channels or frequencies. This chart can also be configured to show channel availability, the percentage of each channel that is unused and available for additional traffic.

Channel Quality is a weighted metric derived from key parameters which include noise, non-Wi-Fi (interferer) utilization and duty-cycles and certain types of retries. Quality levels are indicated by a range of colors between dark blue, which represents a higher channel quality, and red, which represents a lower channel quality. Channel availability is indicated by a range of colors between dark blue, which represents 100% channel availability, and red, which represents 0% availability.



NOTE: For additional information on interpreting a Dell Spectrogram plot, see ["Swept Spectrogram"](#) on page 603.

The Spectrum Analysis Quality Spectrogram chart measures channel data each second, so after every 5-second sweep, the newest data appears as a thin colored line on the bottom of the chart. Older data is pushed up higher on the chart until it reaches the top of the spectrogram and ages out. The example below shows the Dell Quality Spectrogram chart after it has recorded over 1500 seconds of FFT data.

Figure 225: Quality Spectrogram

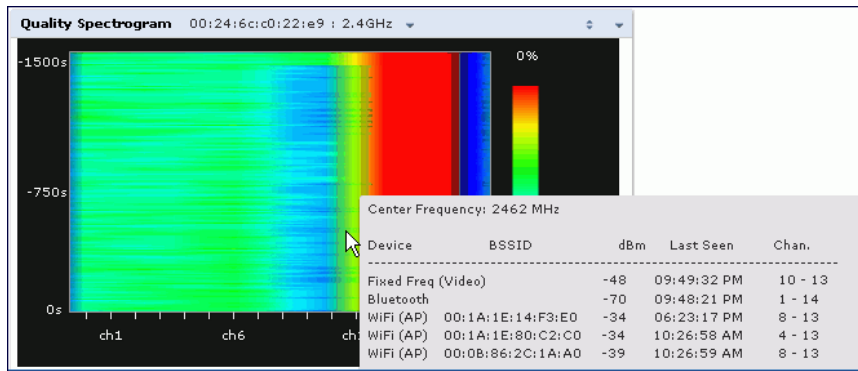

When you hover your mouse over any part of the spectrogram, a tooltip shows the devices the spectrum monitor detected on that frequency, the BSSID of the device (if applicable), the power level of the device in dBm, the time the device was last seen by the spectrum monitor, and the channels affected by the device.

The following table describes the other optional parameters you can use to customize the Quality Spectrogram. Click the down arrow in the upper right corner of this chart then click the **Options** menu to access these configuration settings. Once you have configured the desired parameters, click **OK** at the bottom of the **Options** menu to save your settings and return to the spectrum dashboards

Table 226: Quality Spectrogram Options

Parameter	Description
Band	Radio band displayed in this graph. For spectrum monitor radios using the 5 GHz radio band, click the Band drop-down list and select 5 GHz upper , 5GHz middle or 5GHz lower to display data for that portion of the 5 GHz radio band. This parameter is not configurable for graphs created by hybrid APs or spectrum monitor radios that use the 2.4 GHz radio band.
Channel Numbering	For spectrum monitors using the 5 GHz radio band, select either 20 MHz or 40 MHz channel numbering to identify a channel numbering scheme for the graph. NOTE: This parameter is not configurable for graphs created by hybrid APs or spectrum monitor radios that use the 2.4 GHz radio band. A hybrid AP on a 20 MHz channel sees 40 MHz Wi-Fi data as non-Wi-Fi data.
Channel Range	Specify a channel range to determine which channels appear in the x-axis of this chart. Click the first drop-down list to select the lowest channel in the range, then click the second drop-down list to select the highest channel to appear in the chart. NOTE: This parameter is not configurable for graphs created by hybrid APs.

Real-Time FFT

The Real-time FFT chart displays the instantaneous Fast Fourier Transform (FFT) signature of the RF signal seen by the radio. The Fast Fourier Transform (FFT) converts a RF signal from time domain to frequency domain. The frequency domain representation divides RF signals into discrete frequency bins; small frequency ranges whose width depends on the resolution bandwidth of the spectrum monitor (i.e., how many Hz are represented by a single signal strength value). Each frequency bin has a corresponding signal strength value. Since there may be a large number of FFT signatures received by the radio every second, an algorithm selects one FFT sample to display in the Real-time FFT chart every second.



NOTE: This chart is not available for W-AP120 Series or W-AP68 access points. A hybrid AP on a 20 MHz channel will see 40 MHz Wi-Fi data as non-Wi-Fi data.

This chart can show an average for all samples taken over the last second, the maximum FFT power measured for all samples taken over ten channel sweeps, and the greatest FFT power recorded since the chart was last reset. When you hover your mouse over any line, a tooltip shows the power level and channel or frequency level represented by that point in the graph. When you hover your mouse over a frequency level (within the blue brackets on the graph), a tooltip shows the types of devices seen on that frequency, as well as each device's BSSID, power level, channels affected and the time the device was last seen by the spectrum monitor.

Figure 227: Real-Time FFT

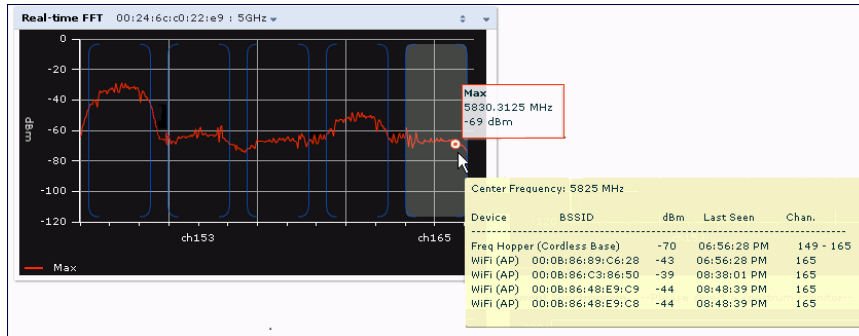

By default, this chart shows the maximum power level recorded for any device on all channels or frequencies monitored by the spectrum monitor radio.

Table 228 describes the other parameters you can use to customize the Real-time FFT chart. Click the down arrow in the upper right corner of this chart then click the **Options** menu to access these configuration settings. Once you have configured the desired parameters, click **OK** at the bottom of the **Options** menu to save your settings and return to the spectrum dashboards.

Table 228: Real-Time FFT Options

Parameter	Description
Band	Radio band displayed in this graph. For spectrum monitor radios using the 5 GHz radio band, click the Band drop-down list and select 5 GHz upper , 5GHz middle or 5GHz lower to display data for that portion of the 5 GHz radio band. This parameter is not configurable for graphs created by hybrid APs or spectrum monitor radios that use the 2.4 GHz radio band.
Channel Numbering	For spectrum monitors using the 5 GHz radio band, select either 20 MHz or 40 MHz channel numbering to identify a channel numbering scheme for the graph. NOTE: This parameter is not configurable for graphs created by hybrid APs or spectrum monitor radios that use the 2.4 GHz radio band. A hybrid AP on a 20 MHz channel sees 40 MHz Wi-Fi data as non-Wi-Fi data.
X-Axis	Select either Channel or Frequency to show FFT power for a range of channels or frequencies. If you select Frequency , you must select the radio frequency on which this chart should center, and determine the span of frequencies for the graph.
Channel Range	If you selected Channel in the X-Axis parameter, you must also specify a channel range to determine which channels appear in the X-axis of this chart. Click the first drop-down list to select the lowest channel in the range, then click the second drop-down list to select the highest channel to appear in the chart.

Parameter	Description
	NOTE: This parameter is not configurable for graphs created by hybrid APs.
Center Frequency	If you selected Frequency in the X-Axis parameter, enter the frequency, in MHz, that you want to appear in the center of the x-axis of this chart.
Span	If you selected Frequency in the X-Axis parameter, specify the size of the range of frequencies around the selected center frequency. If you set a frequency span of 100 MHz, for example, the chart shows the FFT duty cycle for a range of frequencies from 50MHz lower to 50 MHz higher than the selected center.
Y-axis	Select the range of power levels, in -dBm, to appear in the y-axis of this chart. Enter the lower value in the right field, and the higher value in the left field.
Show	Select the checkbox by the following items to display that information on the FFT Power chart. <ul style="list-style-type: none"> ● Average: The average power level of all samples recorded during the last 10 sweeps. ● Max: The highest power recorded during the last 10 channel sweeps. ● Max Hold: The highest maximum power level recorded since the chart data was reset. To clear this setting, click the down arrow at the end of the title bar for this graph and select Clear Max Hold.

Swept Spectrogram

A spectrogram is a chart that shows how the density of the quantity being plotted varies with time. The spectrum analysis Swept Spectrogram chart plots real-time FFT Maximums, real-time FFT Averages or the FFT Duty Cycle. In this swept spectrogram, the x-axis represents frequency or channel and the y-axis represents time. Each line in the swept spectrogram corresponds to the data displayed in the Real-Time FFT or FFT Duty Cycle chart.



NOTE: This chart is not available for W-AP120 Series or W-AP68 access points. A hybrid AP on a 20 MHz channel will see 40 MHz Wi-Fi data as non-Wi-Fi data.

The power or duty cycle values recorded in each sweep are mapped to a range of colors. In the average or maximum FFT power Swept Spectrogram charts, the signal strength levels are indicated by a range of colors between dark blue, which represents -90 dBm, and red, which represents a higher -50 dBm. The duty cycle Swept Spectrogram chart shows the percentage of the time tick interval that the selected channel or frequency was broadcasting a signal. These percentages are indicated by a range of colors between dark blue, which represents a duty cycle of 0% percent, and red, which represents a duty cycle of 100%.

A spectrogram plot is a complex chart that can display a lot of information. If you are not familiar with these types of charts, they may be difficult to interpret. The following illustrations can help explain how FFT power data is rendered in a spectrogram format.

The example in [Figure 229](#) shows how an FFT Power chart could appear if a single data measurement was plotted as a simple line graph.

Figure 229: Simple Line Graph of FFT Power Data

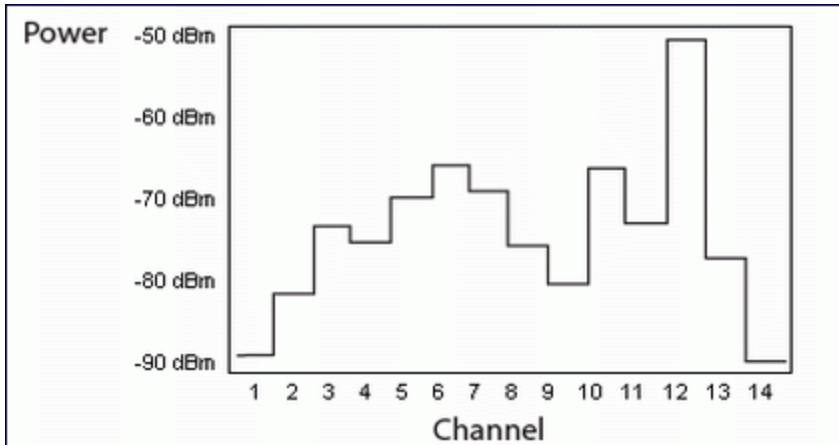

Now, suppose that each channel's FFT power level was also represented by a color that corresponded to that specific FFT power level. In the example below, channel 12 has a FFT power level of -50 dBm, so it is represented by the color red. Channel 1 has a FFT power level of -85 dBm, so it is represented by dark blue.

Figure 230: FFT Power Line Graph with Color

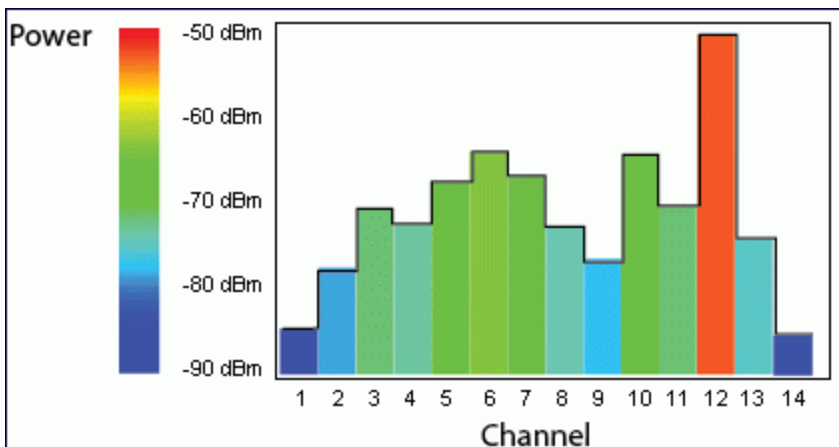

If the graph was then flattened so each channel's FFT power for that single-second sweep was represented only by a color (and not by a value on the y-axis), the graph could then appear as follows:

Figure 231: FFT Power Spectrogram Sample

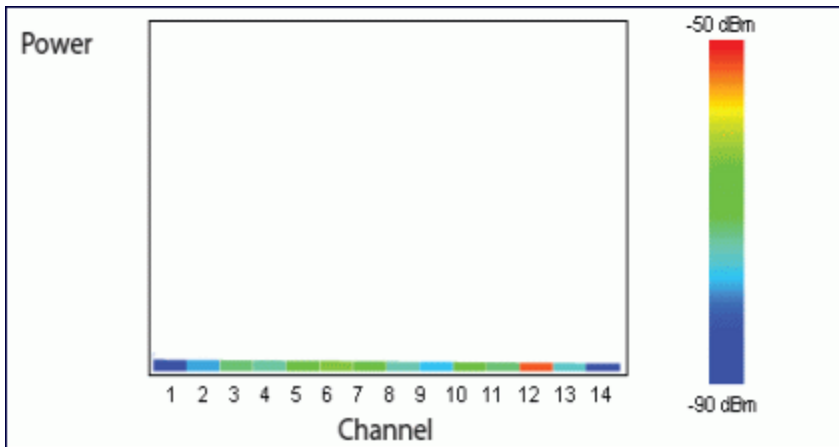

The spectrum analysis Swept Spectrogram measures FFT power levels or duty cycle data each second, so after every 1-second sweep, the newest data appears as a thin colored line on the bottom of the chart. Older data is pushed up higher on the chart until it reaches the top of the spectrogram and ages out. The example below shows the Swept Spectrogram chart after it has recorded over 300 seconds of FFT data.

Figure 232: Swept Spectrogram

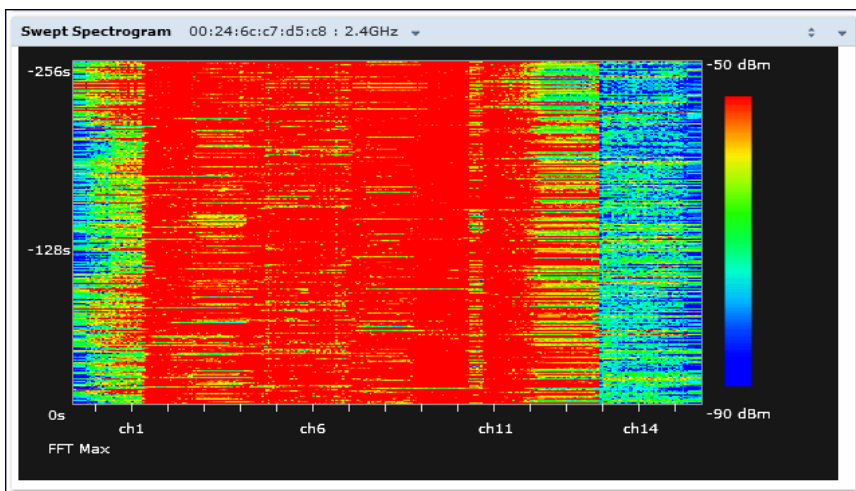

[Table 233](#) describes the parameters you can use to customize the Swept Spectrogram chart. Click the down arrow in the upper right corner of this chart then click the **Options** menu to access these configuration settings. Once you have configured the desired parameters, click **OK** at the bottom of the **Options** menu to save your settings and return to the spectrum dashboards.

Table 233: Swept Spectrogram Options

Parameter	Description
Band	Radio band displayed in this graph. For spectrum monitor radios using the 5 GHz radio band, click the Band drop-down list and select 5 GHz upper , 5GHz middle or 5GHz lower to display data for that portion of the 5 GHz radio

Parameter	Description
	band. This parameter is not configurable for graphs created by hybrid APs or spectrum monitor radios that use the 2.4 GHz radio band.
Channel Numbering	For spectrum monitors using the 5 GHz radio band, select either 20 MHz or 40 MHz channel numbering to identify a channel numbering scheme for the graph. NOTE: This parameter is not configurable for graphs created by hybrid APs or spectrum monitor radios that use the 2.4 GHz radio band.
X-Axis	Select either Channel or Frequency . to show FFT power or duty cycles for a range of channels or frequencies. If you select Frequency , you must select the radio frequency on which this chart should center, and determine the span of frequencies for the graph.
Channel Range	If you selected Channel in the X-Axis parameter, you must also specify a channel range to determine which channels appear in the x-axis of this chart. Click the first drop-down list to select the lowest channel in the range, then click the second drop-down list to select the highest channel to appear in the chart. NOTE: This parameter is not configurable for graphs created by hybrid APs.
Center Frequency	If you selected Frequency in the X-Axis parameter, enter the frequency, in MHz, that you want to appear in the center of the x-axis of this chart.
Span	If you selected Frequency in the X-Axis parameter, specify the size of the range of frequencies around the selected center frequency. If you set a frequency span of 100 MHz, for example, the chart shows the swept spectrogram for a range of frequencies from 50MHz lower to 50 MHz higher than the selected center.
Color-Map Range	<i>If this chart is configured to show average or maximum FFT values</i> , the default color range on this chart represents values from -50dBm (red) to -90dBm (blue). If you would like the color range on this chart to represent a different range of FFT power levels, enter this range in the from and to entry blanks. For example, if you defined a color-map range from -60 to -80, then any FFT power level at or above -60 dBm would appear as red, and any FFT power level at or below -80 would appear blue. Only the channel or frequency qualities between -60 dBm and -80 dBm would be represented by gradiented colors within the color range. <i>If this chart is configured to show the FFT duty cycle</i> , the default color range on this chart represents duty cycles from 0% (red) to 100% (blue). If you would like the color range on this chart to represent a different range of FFT duty cycle percentages, enter this range in the from and to entry blanks. For example, if you defined a color-map range from 25 to 75, then any FFT duty cycle at or below 25% would appear as red, and any FFT duty cycle at or below 75% would appear blue. Only the duty cycle levels between 25% and 75% would be represented by gradiented colors within the color range. NOTE: If your swept spectrogram is showing a single color only, you may need to increase the color map range to display a greater range of values.
Show	Select FFT Avg , FFT Max or FFT Duty Cycle to select the type of data you want to appear in this chart.

Working with Non-Wi-Fi Interferers

The following table describes each type of non-Wi-Fi interferer detected by the spectrum analysis feature. These devices appear in the following charts:

- Active Devices
- Active Devices Table
- Active Devices Trend
- Device Duty Cycle

- Device vs Channel
- Interference Power

Table 234: Non-Wi-Fi Interferer Types

Non-Wi-Fi Interferer	Description
Bluetooth	Any device that uses the Bluetooth protocol to communicate in the 2.4 GHz band is classified as a <i>Bluetooth</i> device. Bluetooth uses a frequency hopping protocol.
Fixed Frequency (Audio)	Some audio devices such as wireless speakers and microphones also use fixed frequency to continuously transmit audio. These devices are classified as <i>Fixed Frequency (Audio)</i> .
Fixed Frequency (Cordless Phones)	Some cordless phones use a fixed frequency to transmit data (much like the fixed frequency video devices). These devices are classified as <i>Fixed Frequency (Cordless Phones)</i> .
Fixed Frequency (Video)	Video transmitters that continuously transmit video on a single frequency are classified as <i>Fixed Frequency (Video)</i> . These devices typically have close to a 100% duty cycle. These types of devices may be used for video surveillance, TV or other video distribution, and similar applications.
Fixed Frequency (Other)	All other fixed frequency devices that do not fall into one of the above categories are classified as <i>Fixed Frequency (Other)</i> . Note that the RF signatures of the fixed frequency audio, video and cordless phone devices are very similar and that some of these devices may be occasionally classified as Fixed Frequency (Other).
Frequency Hopper (Cordless Base)	Frequency hopping cordless phone base units transmit periodic beacon-like frames at all times. When the handsets are not transmitting (i.e., no active phone calls), the cordless base is classified as <i>Frequency Hopper (Cordless Base)</i> .
Frequency Hopper (Cordless Network)	When there is an active phone call and one or more handsets are part of the phone conversation, the device is classified as <i>Frequency Hopper (Cordless Network)</i> . Cordless phones may operate in 2.4 GHz or 5 GHz bands. Some phones use both 2.4 GHz and 5 GHz bands (for example, 5 GHz for Base-to-handset and 2.4 GHz for Handset-to-base). These phones may be classified as unique Frequency Hopper devices on both bands.
Frequency Hopper (Xbox)	The Microsoft Xbox device uses a frequency hopping protocol in the 2.4 GHz band. These devices are classified as <i>Frequency Hopper (Xbox)</i> .
Frequency Hopper (Other)	When the classifier detects a frequency hopper that does not fall into one of the above categories, it is classified as Frequency Hopper (Other). Some examples include IEEE 802.11 FHSS devices, game consoles and cordless/hands-free devices that do not use one of the known cordless phone protocols.
Microwave	Common residential microwave ovens with a single magnetron are classified as a <i>Microwave</i> . These types of microwave ovens may be used in cafeterias, break rooms, dormitories and similar environments. Some industrial, healthcare or manufacturing environments may also have other equipment that behave like a microwave and may also be classified as a Microwave device.
Microwave (Inverter)	Some newer-model microwave ovens have the inverter technology to control the power output and these microwave ovens may have a duty cycle close to 100%. These microwave ovens are classified as <i>Microwave (Inverter)</i> . Dual-magnetron industrial microwave ovens with higher duty cycle may also be classified as Microwave (Inverter). As in the Microwave category described above, there may be other equipment that behave like inverter microwaves in some industrial, healthcare or manufacturing environments. Those devices may also be classified as Microwave (Inverter).
Generic Interferer	Any non-frequency hopping device that does not fall into one of the other categories described in this table is classified as a <i>Generic Interferer</i> . For example a Microwave-like device that does not operate in the known operating frequencies used by the Microwave ovens may be classified as a Generic Interferer. Similarly wide-band interfering devices may be classified as Generic Interferers.

Understanding the Spectrum Analysis Session Log

The spectrum analysis **Session Log** tab displays times the spectrum monitors and hybrid APs connected to or disconnected from the spectrum client during the current browser session. This tab also shows changes in a hybrid AP's scanning channel caused by changes to the hybrid AP's 802.11a or 802.11g radio profile or automatic channel changes by the DFS or ARM features. The latest entry in the session log is also displayed in a footer at the bottom of the Spectrum Monitors and Spectrum Dashboard window. When you close the browser and end your spectrum analysis session, the session log is cleared.

The example in [Figure 235](#) shows that a 2.4 GHz radio on hybrid AP was connected to the spectrum analysis client, its channel changed twice, then was disconnected from the spectrum client.

Figure 235: *Spectrum Analysis Session Logs*

MOBILITY CONTROLLER Spectrum > Spectrum Analysis		
Spectrum Dashboards	Spectrum Monitors	Session Log
1	01/13/2011 8:23:30	tal : 2.4GHz subscribed.
2	01/13/2011 8:28:08	Access Point 'tal' changed its channel to '11'
3	01/13/2011 8:28:24	Access Point 'tal' changed its channel to '6'
4	01/13/2011 8:30:01	tal : 2.4GHz un-subscribed.

Access Point 'tal' changed its channel to '6'

Viewing Spectrum Analysis Data

You can use the command-line interface to view spectrum analysis data from any spectrum monitor, even if that spectrum monitor is currently sending data to another spectrum monitor client's WebUI.

[Table 236](#) shows the commands that display spectrum analysis data in the CLI interface.

Table 236: *Spectrum Analysis CLI Commands*

Command	Description
show ap spectrum ap-list	This command shows spectrum data seen by an access point that has been converted to a spectrum monitor.
show ap spectrum channel-metrics	This command shows channel utilization information for a 802.11a or 802.11g radio band, as seen by a spectrum monitor
show ap spectrum channel-summary	This command displays a summary of the 802.11a or 802.11g channels seen by a spectrum monitor.
show ap spectrum client-list	This command shows details for Wi-Fi clients seen by a specified spectrum monitor.
show ap spectrum debug	Sub-commands under this command save spectrum analysis channel information to a file on the controller.
show ap spectrum device-duty-cycle	Shows the current duty cycle for devices on all channels being monitored by the spectrum monitor radio.

Command	Description
show ap spectrum device-history	This command displays spectrum analysis history for non-interfering devices.
show ap spectrum device-list	Show a device summary table and channel information for non-Wi-Fi devices currently seen by the spectrum monitor.
show ap spectrum device-log	This command shows a time log of add and delete events for non-Wi-Fi devices.
show ap spectrum device-summary	This command shows the numbers of Wi-Fi and non-Wi-Fi device types on each channel monitored by a spectrum monitor.
show ap spectrum interference-power	This command shows the interference power detected by a 802.11a or 80211g radio on a spectrum monitor.
show ap spectrum monitors	This command shows a list of APs currently configured as spectrum monitors.
show ap spectrum technical-support	Save spectrum data for later analysis by your Dell technical support representative.

Recording Spectrum Analysis Data

The spectrum analysis tool allows you to record up to 60 continuous minutes (or up to 10 Mb) of spectrum analysis data. By default, each spectrum analysis recording displays data for the Real-Time FFT, FFT Duty Cycle, Interference Power and Swept Spectrogram charts, however, you can view recorded device data for any the spectrum analysis charts supported by that spectrum monitor radio. Configurable recording settings allow you to start a recording session immediately, or schedule a recording to begin at a later date and time. Each recording can be scheduled to end after a selected amount of time has passed, or continue on until the recorded data file reaches a specified size. You can save the file to your spectrum monitor client, then play back that data at a later time.

Creating a Spectrum Analysis Record

To record spectrum analysis data for later analysis:

1. Navigate to the **Monitoring>Spectrum Analysis>Spectrum Dashboards** window.
2. Click the **Record** button at the top of the window. The **New Recording** popup window appears.
3. Click the **Record From** link, and select the spectrum monitor whose data you want to record.
4. Next, decide whether you want the recording to start immediately, or at a later scheduled time. If you want the recording to start immediately, select **When the OK button is clicked**. To schedule a different starting time for the recording, click the date and time drop-down lists to select a starting month, day, year and time.
5. The recording continues until either the specified amount of time has passed, or until the recording files reaches a selected size. Click the **Length of recording reaches** drop down list and select the amount of time the recording should last, or click the **Data file reaches** drop down list and select the maximum file size for the recording.
6. Click **OK** to save your settings. If you selected the **When the OK button is clicked** in step 5, the recording begins.

Figure 237: Recording Spectrum Analysis Data

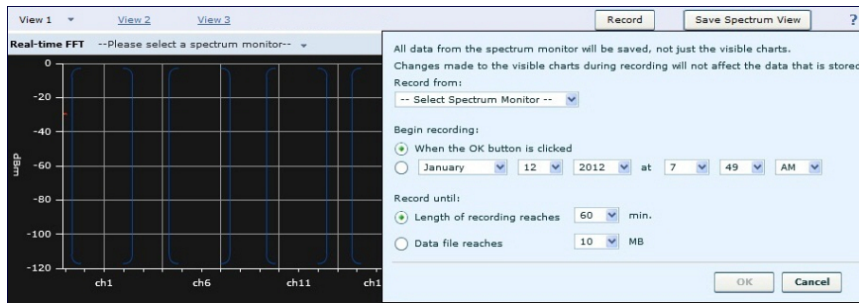

While the recording is in progress, a round, red recording icon and recording status information appears at the top of the spectrum dashboard. You can view data for other spectrum monitors and charts while the recording is in progress. If you want to stop the recording before recording period has finished, click the **Stop** button by the recording status information. When you click the **Stop** button, a popup window appears and allows you to stop and delete the current recording, stop and save the recording in its current state (before it has completed), or continue recording again.

Saving the Recording

After the recording has ended, either because the recording period has elapsed, the recording maximum file size has been reached, the **Spectrum Monitor Recording Complete** window appears and displays information for the current recording.

Figure 238: Saving Spectrum Analysis Data



To save the recording file:

1. From the **Spectrum Monitor Recording Complete** window, click **Continue**.
2. A **Save As** window appears and prompts you to select a file name for the recording and a location to save the file.
3. Click **Save**.

Playing a Spectrum Analysis Recording

There are two ways to play back a spectrum recording. You can use the playback feature in the spectrum dashboard, or view recordings using the Dell PowerConnect W-RFPlayback tool downloaded from the Dell website.

Playing a Recording in the Spectrum Dashboard

The spectrum monitor does not have to be subscribed to your spectrum analysis client in order to play back a recording in the spectrum dashboard. Note, however, that you cannot play back an existing recording in the spectrum dashboard while another recording session is currently in progress.

To play a spectrum analysis recording in the spectrum dashboard:

1. Navigate to **Monitoring>Spectrum Analysis>Spectrum Dashboards** window.
2. Click the **Recording View/Play** link at the top of the window.
3. Click **Load File For Playback**.
4. An **Open** dialog box appears and prompts you to browse to and select the file you want to open.
5. Click **Open**.
6. Click the triangular *play* icon at the top of the window to start playing back the recording.

Recorded data for the selected spectrum monitor and dashboard view appears in the spectrum analysis dashboard. You can replace any of the graphs in the playback window with a different graph type while replaying the recording. A playback progress bar at the top of the window shows what part of the recording currently appears on the dashboard. If you pause the recording, you can click and drag the red slider on this progress bar to advance to or replay any part of the current record.

Playing a Recording Using the RFPlayback Tool

The Dell PowerConnect W-RFPlayback tool can play spectrum recordings created in this and earlier versions of ArubaOS. Dell uses the Adobe AIR application to display spectrum recording information. If you have not done so already, follow the steps below to download and install the free Adobe AIR application and the Dell spectrum playback tool.

1. Download the Adobe Air application from <http://get.adobe.com/air/> and install it on the client on which you want to play spectrum recordings.
2. Next, download the spectrum playback installation file from the Dell website.
3. Open the folder containing the spectrum installation file, and double-click the spectrum.air icon to install the spectrum playback tool. You will be prompted to select the folder in which you want to install this tool.

Once you have installed the Dell PowerConnect W-RFPlayback tool, follow the steps below to load and view a spectrum recording.

1. Start the Spectrum playback application.
2. Click **Load File for Playback**. An **Open** dialog box appears and prompts you to browse to and select the file you want to open.
3. Click the triangular *play* icon at the top of the window play the recording.

The RFPlayback tool also allows you to select and display different graph types while the recording playback is in progress. A playback progress bar at the top of the window shows what part of the recording is displayed in the playback tool. If you pause the recording, you can click and drag the red slider on this progress bar to advance to or replay any part of the current record.

Figure 239: *Playing a Recording with the Spectrum Playback Tool*

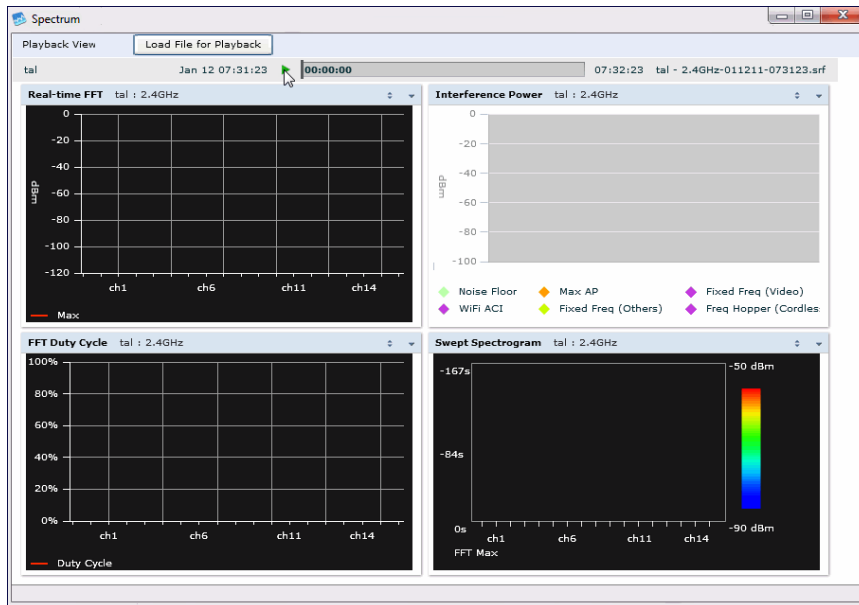

Troubleshooting Spectrum Analysis

Verifying Spectrum Monitors Support for One Client per Radio

Each spectrum monitor radio can only send information to one client at a time. If you log into a controller and the spectrum monitor dashboard does not display any data for the selected radio, another user may be logged in to the controller at that time. Note that dual-radio spectrum monitors may be accessed by two clients; one client for each radio.

Converting a Spectrum Monitor Back to an AP or Air Monitor

If you are trying to convert a spectrum monitor radio back to AP or AM mode but the radio still comes up as a spectrum monitor, access the command-line interface and see if that spectrum monitor appears in the output of the `show ap spectrum local-override` command. If the spectrum monitor does appear in the local override profile table, issue the command `ap spectrum local-override no override ap-name <apname> spectrum-band <spectrum-band>` to remove the local override for that spectrum monitor and return the radio to AP or AM mode.

Troubleshooting Browser Issues

If you access the spectrum analysis dashboard using the Safari 5.0 browser, clicking the backspace button may return you to the previous browser screen. Avoid using the backspace button when changing dashboard view names or chart options.

If you are recording spectrum analysis data or playing back a spectrum analysis recording using a Mac client, do not minimize the browser window while the recording is in progress, as that may cause the Adobe Flash player to pause.

Loading a Spectrum View

Saved spectrum view preferences may not be backwards compatible with the spectrum analysis dashboard in earlier versions of ArubaOS. If you downgrade to an earlier version of ArubaOS and your client is unable to load a saved spectrum view in the spectrum dashboard, access the CLI in enable mode and issue the command `ap spectrum`

`clear-webui-view-settings` to delete the saved spectrum views and display default view settings in the spectrum dashboard.

Troubleshooting Issues with Adobe Flash Player 10.1 or Later

Removing focus from the browser window displaying the spectrum analysis dashboard may cause Adobe Flash 10.1 or later to stop updating the spectrum charts in order to reduce CPU usage. When you restore focus to the spectrum analysis dashboard, you may see the spectrum charts update rapidly as the display catches up. Recorded data may be inaccurate if you navigate away from the spectrum window during a recording. Flash 10.0 does not have this issue.

Understanding Spectrum Analysis Syslog Messages

The spectrum analysis feature can send four different types of syslog messages: wifi add, wifi delete, non-wifi add, and non-wifi delete. All messages are in the wireless category at the syslog severity level NOTICE.

The four syslog message types appear in the following formats:

- AM: Spectrum: new wifi device found = [addr:%s] SSID = [ssid:%s] BSSID [bssid_str:%s] DEVICE ID [did:%d]
- AM: Spectrum: deleting wifi device = [addr:%s] SSID = [ssid:%s] BSSID [bssid_str:%s] DEVICE ID [did:%d]
- AM: Spectrum: new non-wifi device found = DEVICE ID [did:%u] Type [dtype:%s] Signal [sig:%u] Freq [freq:%u]KHz Bandwidth [bw:%u]KHz
- AM: Spectrum: deleting non-wifi device = DEVICE ID [did:%d] Type [dtype:%s]

Playing a Recording in the RFPlayback Tool

The Dell PowerConnect W-RFPlayback tool is periodically updated to support improvements to the ArubaOS Spectrum Analysis feature. The RFPlayback tool can play spectrum recordings created in the same version of ArubaOS or earlier releases. If the RFPlayback tool cannot load a newer recording, you may need to download a more recent version of the tool from the Dell website.

Understanding Device Ageout Times

Each 802.11a and 802.11g radio profile references a spectrum profile which defines the ageout times for each monitored device type. Best practices are to keep these settings at their default values unless asked to do so by Dell support. Changing the timers from their default values may affect classification accuracy and may result in incorrect and missed classifications.

Use the following procedure to edit a spectrum profile (under the supervision of Dell support).

1. Navigate to the **Configuration > Advanced Services > All Profiles** window.
2. Under the Profiles list, expand the **RF Management** menu.
3. To edit a spectrum profile for a spectrum monitor's 802.11a radio band, expand the **802.11a radio profile** menu.
-or-
To edit a spectrum profile for a spectrum monitor's 802.11g radio band, expand the **802.11g radio profile** menu.
4. Expand the menu for the 802.11a or 802.11g radio profile whose spectrum profile you want to change.
5. In the profile list, select the Spectrum Profile assigned to the 802.11a or 802.11g radio profile. Details for that Spectrum profile appear in the Profile Details window.
6. Configure the spectrum profile options as described in [Table 240](#)



NOTE: For additional details about non-Wi-Fi device types described in [Table 240](#), see "[Working with Non-Wi-Fi Interferers](#)" on [page 606](#).

Table 240: Spectrum Profile Parameters

Parameter	Description
Age Out: WIFI	Ageout time for Wi-Fi devices. Default: 600 seconds.
Age Out: Generic Interferer	Ageout time for generic devices. Default: 30 seconds.
Age Out: Microwave	Ageout time for microwave ovens. Default: 15 seconds.
Age Out: Microwave (Inverter type)	Ageout time for inverter microwave ovens. Default: 15 seconds.
Age Out: Video Device	Ageout time for video devices. Default: 60 seconds.
Age Out: Audio Device	Ageout time for audio devices. Default: 10 seconds.
Age Out: Cordless Phone Fixed Frequency	Ageout time for fixed frequency cordless phones. Default: 10 seconds.
Age Out: Generic Fixed Frequency	Ageout time for generic fixed-frequency devices. Default: 10 seconds.
Age Out: Bluetooth	Ageout time for Bluetooth devices. Default: 25 seconds.
Age Out: Xbox	Ageout time for Xbox consoles. Default: 25 seconds.
Age Out: Cordless Network Frequency Hopper	Ageout time for cordless network frequency hopping devices. Default: 60 seconds.
Age Out: Cordless Base Frequency Hopper	Ageout time for cordless base frequency hopping devices. Default: 240 seconds.
Age Out: Generic Frequency Hopper	Define the ageout time for Generic Frequency Hopper devices. Default: 25 seconds.

- Click **Apply** to save the changes to the existing spectrum profile, or, to create a new spectrum profile with the updated settings, click **Save As**, enter a name for the new spectrum profile, then click **Apply**.

To create edit spectrum profile via the command-line interface, access the CLI in config mode and issue the following commands:

```
rf spectrum-profile <profile>
  age-out {audio <secs>|bluetooth <secs>|cordless-base-freq-hopper <secs>|cordless-
network-freq-hopper <secs>|cordless-phone-fixed-frequency <secs>|generic-fixed-
frequency <secs>|generic-freq-hopper <secs>|generic-interferer <secs>|microwave
<secs>|microwave-inverter <secs>|video <secs>|wifi <secs>|xbox <secs>}
  clone <profile>
no
```

Chapter 33

Dashboard Monitoring

The ArubaOS dashboard monitoring functionality provides enhanced visibility into your wireless network performance and usage within a controller. This allows you to easily locate and diagnose WLAN issues in the controller.

The dashboard monitoring is available via the WebUI. To monitor and troubleshoot RF issues in the WLAN, click the **Dashboard** tab. The following pages in the **Dashboard** page allows you to view various performance and usage information:

- Performance
- Usage
- Security
- Potential Issues
- WLANs
- Access Points
- Clients
- Firewall

Additionally, you can view the context sensitive help for each field in the **Dashboard** UI by clicking the **help** link at the topmost right corner of the UI. The field for which the help has been defined appears as green. You can turn off the **help** by clicking on the **Done** button.

Monitoring Performance

This page displays the performance details of the wireless clients and APs connected to the controller.

Clients

This section displays the total number of wireless clients connected to the controller. You can view the distribution of clients in different SNR ranges, associated data rate ranges, and data transfer speed ranges using the histograms. You can click on the hyperlinked number to view the **Clients** page. Additionally, you can view the following client performance details:

- Signal to noise ratio (SNR)
- Phy type
- Client connection speed
- Effective data rate of the clients connected to the controller

To understand histogram information, see ["Using Dashboard Histograms" on page 616](#).

APs

This section displays the following performance details of the APs on the controller:

- To client or from client frame rates

- Overall goodput
- Percentage of frames dropped
- Frame rate distribution of the APs

Additionally, you can view the distribution of the APs in different noise floor ranges, channel utilization ranges, and non-Wi-Fi interference ranges using the histograms. To understand histogram information, see "[Using Dashboard Histograms](#)" on page 616.

Using Dashboard Histograms

Dashboard histograms are a visual representation of the distribution of the wireless clients, access points, and radios across different performance parameters in the controller. Histograms help you to quickly identify any performance issues in the network from the color of the distribution. For example, critical ranges of the distribution are highlighted in red and the normal ranges are highlighted in green.

You can view the number of clients or APs falling in each range of the distribution with a hyperlink. You can also perform the following tasks on the histograms to get additional information on the clients and APs in the distribution:

- **View Client or AP details:** Click the hyperlinked number to view the details of the clients or APs in a pop-up window.
- **Sort:** Click a column header of the clients or APs table to sort the complete list based on the entries on the active column. You can also use the sort icon that appears when you click on a column for sorting.
- **Filter:** Click the filter icon and select the filter criterion on any column to filter the entries.
- **Customize column view:** Select or deselect the columns to view or hide by doing a right click on the clients or AP table header.
- **Close pop-up window:** Click on the close icon to close the client or AP details pop-up window.

Monitoring Usage

This page displays the usage details of the clients and APs on the controller.

Clients

This section displays the client and WLAN utilization in the controller. You can view the trends of the following client usage details in the last 15 minutes:

- Number of wireless clients connected to the controller
- Number of active wireless clients
- Number of wireless clients that have low usage
- Number of wireless clients associated per WLAN

Additionally, you can click on the hyperlinked number to view the respective client details on the **Clients** page.

APs

This section displays the AP utilization in the controller. You can view the following AP and radio details:

- Number of APs
- Number of APs that are down
- Radios with low usage
- Overall AP usage

You can click on the hyperlinked number to view the respective AP or radio details on the **Access Points or Radios** page. Additionally, you can view the trends of the average data bytes transmitted and received by the AP per second and the usage per WLAN in the last 15 minutes.

Monitoring Security

This page allows you to monitor the detection and protection of wireless intrusions in your network.

The two top tables—Discovered APs & Clients and Events—contain data as links. When these links are selected they arrange, filter, and display the appropriate information in the lower table.



NOTE: The term *events* in this document refers to security threats, vulnerabilities, attacks (intrusion or Denial of Service) and other related events.

Monitoring Potential Issues

This page displays the total number of radios and wireless clients that may have potential issues in the network. You can right click on the total number to view the trend of the clients and radios with potential issues in the last 15 minutes. You can also view the number of clients or radios that have a specific potential issue in each radio band.

The potential issues that a client may have are:

- **Low SNR:** Clients that have signal to noise ratio of 30 dBm or lower.
- **Low speed:** Clients that have a connection speed of 36 Mbps or lower.
- **Low goodput:** Clients that have an average data rate of 24 Mbps or lower.

The potential issues that a radio may have are:

- **High noise floor:** Radios that have a noise floor of -85 dB or greater.
- **Busy channel:** Radios that have a channel utilization of 80% or greater.
- **High non-Wi-Fi interference:** Radios that have a non-Wi-Fi interference of 20% or greater.
- **Low goodput:** Radios that have an average data rate of 24 Mbps or lower.
- **High client association:** Radios that have 15 or more clients connected.

You can click on the hyperlinked number to view the details of the respective clients or radios in the bottom pane of the page. You can perform the following tasks on the details table:

- **Sort:** Click a column header of the table to sort the complete list based on the entries on the active column. You can also use the sort icon that appears when you click on a column for sorting.
- **View or hide columns:** Select or deselect the columns to view or hide by doing a right click on the table header.

Monitoring WLANs

You can view the WLAN details such as the number of associated APs, radios, and wireless clients as well as the WLAN usage in the controller. You can also view the details of the associated APs and clients as tables. You can perform the following tasks on this page:

- **Sort:** Click a column header of the WLAN table to sort the complete list based on the entries on the active column. You can also use the sort icon that appears when you click on a column for sorting.
- **Filter:** Click the filter icon and select the filter criterion on any column of the details table to filter the entries.

- **Customize column view:** Select or deselect the columns to view or hide by doing a right click on the details table header. You can also choose one of the following system defined views that have the appropriate pre-selected columns.
 - Default Columns
 - To/From Client Stats
- **View WLAN trends:** View the trends of the clients connected in the WLAN and the WLAN usage in the last 15 minutes.
- **View client summary:** Click on the hyperlinked client name on the client details table to view the **Client Summary** page. In this page, you can view the client details summary (air quality metrics and from and to clients statistics), bandwidth of the client usage, trend of the client frame loss in the last 15 minutes, and the frame rate distribution of the client.
- **View AP or radio summary:** Click on the hyperlinked AP name or the radio band on the AP details table to view the **Access Points** page. In this page you can view the summary of the AP details such as air quality metrics, from and to clients statistics, and the number of clients associated with the AP under different SNR ranges. Additionally, you can view the details of the associated clients and WLANs.

Monitoring Access Points

You can view the details of all the radios and APs associated with the controller by selecting the respective tab. You can also view the trends of the connected wireless clients and the client usage under the 2.4 Ghz and 5 Ghz radio bands in the last 15 minutes.

You can perform the following tasks on this page:

- **Sort:** Click a column header of the AP table to sort the complete list based on the entries on the active column. You can also use the sort icon that appears when you click on a column for sorting.
- **Filter:** Click the filter icon and select the filter criterion on any column of the details table to filter the entries.
- **Customize column view:** Select or deselect the columns to view or hide by doing a right click on the details table header. You can also choose one of the following system defined views that have the appropriate pre-selected columns.
 - Default Columns
 - Air Quality Metrics
 - To/From Client Stats
- **View client details:** Click on the number of clients associated with the AP to view the details of the clients on the **Clients** page.
- **View AP or radio summary:** Click on the hyperlinked AP name or the radio band on the AP details table to view the summary of the AP details such as air quality metrics, from and to clients statistics, and the number of clients associated with the AP under different SNR ranges. Additionally, you can view the details of the associated clients and WLANs.

Monitoring Clients

You can view the details of all the wireless clients on the controller. You can also view the trends of the connected clients and the client usage under the 2.4 Ghz and 5 Ghz radio bands in the last 15 minutes.

You can perform the following tasks on this page:

- **Sort:** Click a column header of the AP table to sort the complete list based on the entries on the active column. You can also use the sort icon that appears when you click on a column for sorting.
- **Filter:** Click the filter icon and select the filter criterion on any column of the details table to filter the entries.

- **Customize column view:** Select or deselect the columns to view or hide by doing a right click on the details table header. You can also choose one of the following system defined views that have the appropriate pre-selected columns.
 - Default Columns
 - Air Quality Metrics
 - To/From Client Stats
- **View client summary:** Click on the hyperlinked client name on the client details table to view the **Client Summary** page. In this page, you can view the client details summary (air quality metrics and from or to clients statistics), bandwidth of the client usage, trend of the client frame loss in the last 15 minutes, and the frame rate distribution of the client.
- **View AP details:** Click on the hyperlinked AP name to view the **Access Points** page.
- **View WLAN details:** Click on the hyperlinked SSID of the WLAN to view the **WLANs** page.

Monitoring Firewalls

The **Firewall** page on the **Dashboard** tab displays the Policy Enforcement Firewall (PEF) summary of all the sessions in the controller aggregated by users, devices, destinations, applications, WLANs, and roles.

By default, firewall visibility is disabled on the controller. To enable this feature, use the following procedures.

In the WebUI

1. Navigate to the **Dashboard > Firewall** page.
2. Click the link on the **Element View** section to enable firewall visibility. To disable, click the **Disable Firewall** link at the bottom of the **Element View** section.

In the CLI

```
(host) (config) #firewall-visibility
```

To disable this setting, include the `no` parameter.

```
no firewall-visibility
```



NOTE: The PEF visibility feature is supported in W-3000 Series, W-6000M3, and W-7200 Series Dell controllers and requires the PEFNG license.

Element View

Navigate to the **Dashboard > Firewall** page to view **Element View** section. This section displays a summary of all the sessions in the controller and includes six categories of monitoring data, or elements, that display traffic statistics aggregated by the following elements:

Table 241: *Element View*

Element	Description
User	Indicates a wireless or wired user associated to the controller. Traffic that is not generated by a user is aggregated as non-user traffic .
Devices	Specifies the client device type. For example, Windows 7, Mac OS X, iPhone, or Android.

Element	Description
Destinations	Destination hostname, or IP address if the hostname is not available. Common advertising and file sharing services on the Internet are categorized under special destinations called ad networks and file share networks respectively.
Applications	Application name, protocols, and ports. For example: <ul style="list-style-type: none"> • Web applications: YouTube, Twitter, Facebook, and more. • Stateful applications: FTP, Lync, SIP, and more. • Custom applications: Using the <code>netSERVICE</code> command, you can define custom applications if the application uses well-known port numbers (0 to 1023). • Peer-to-Peer: All peer-to-peer traffic is classified under peer to peer. If a session does not map to any of the above, the destination port is classified as application .
WLANs	The service set identifier (SSID) that uniquely identifies the WLAN. Wired connection is shown as wired .
Roles	Determines the user's network privileges based on the assigned user role.

The **Element View** section has two views: **Chart** and **Table**. Click the **Chart** or **Table** button at the top-right corner of an element to toggle between the two views. Each chart container shows the top five sessions with respect to traffic bandwidth and the rest are shown as **Others**. Click **Others** within the chart to view the rest of the sessions in the chart. Click any entry on the chart legend to view more usage details. The figure below shows the **Chart** view.

Figure 242: Chart View

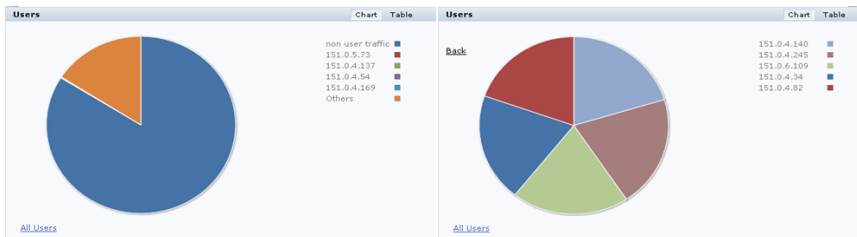

In addition to the element, the **Table** view shows the common fields displayed in the table below.

Table 243: Table View Fields

Column	Description
Bytes	Total number of bytes transmitted and received by an element.
Tx Bytes	Total number of bytes transmitted by an element.
Rx Bytes	Total number of bytes received by an element.

You can perform the following tasks in the **Table** view:

- **Sort:** Click a column header of the table to sort the list by column. You can also use the sort icon that appears when you click on a column.
- **Filter:** Click the filter icon on the first column and select the filter criterion to filter the entries.

Details View

Navigate to the **Dashboard > Firewall** page. Click the **All <element>** link to view the **Details View** page. There are four sections on this page.

Element Tab

The **Element Tab** shows the available usage detail elements. Click an element to view more usage details.

Figure 244: Element Tab

User	Destination	Application	WLAN	Device	Role
------	-------------	-------------	------	--------	------

Element Summary View

The **Element Summary View** displays a detailed view of all the six elements and their corresponding fields.

Figure 1a Element Summary View





Rows (5)				
User	Bytes	Packets	Destination	
10.16.22.89	 143.2 K	549		10
10.16.22.87	 132.3 K	598		6
10.16.22.81	 94.5 K	459		8
10.16.22.80	 87.3 K	283		5
10.16.22.79	 261	4		1

Figure 1b Element Summary View (continued)

Application	WLAN	Device	Role
12	UILab	Win 7	UILab_ACL
18	UILab	Win 7	UILab_ACL
16	UILab	Win 7	UILab_ACL
5	UILab	Win 7	UILab_ACL
1	UILab	iPhone	UILab_ACL

See the following table for more information on **Element Summary View** fields.

Table 245: Element Summary View Fields

Column	Description
User	Indicates a wireless or wired user associated to the controller. Click a User IP address to view details of the connected client.
Bytes	Total number of bytes transmitted and received by an element.
Packets	Total number of data packets transmitted and received by an element.
Device	Specifies the client device type. Click the number to view details of the device type identification.
Destination	Total number of destination hostnames or IP addresses. Click the number to view details of the destination hosts.

Column	Description
Application	Total number of application name, protocols, and ports. Click the number to view details of the application ports.
WLAN	The service set identifier (SSID) that uniquely identifies the WLAN. Click the number to view details of the WLAN SSID.
Role	Determines the user's network privileges based on the assigned user role. Click the number to view details of the role.

You can perform the following tasks in the **Element Summary View**:

- **Sort**: Click a column header of the table to sort the list by column. You can also use the sort icon that appears when you click on a column.
- **Filter**: Click the filter icon on the first column and select the filter criterion to filter the entries.

Usage Breakdown

In the **Usage Breakdown** section you can apply any of the filters that are listed under each element to customize the output. To apply a filter, click any row under each element. The selected row turns yellow. The filtered output is displayed in the **Element Summary View** and **Aggregated Sessions** sections of the page. Click the row again to deselect it and remove the filter. For example, if you click `autodiscover.arubanetworks.com` under **Destination**, and `salesforce.com` under **Application**, the **Element Summary View** and **Aggregated Sessions** sections display session information based on the selected rows. The following figure shows the selected row in each element.

Figure 246: Usage Breakdown

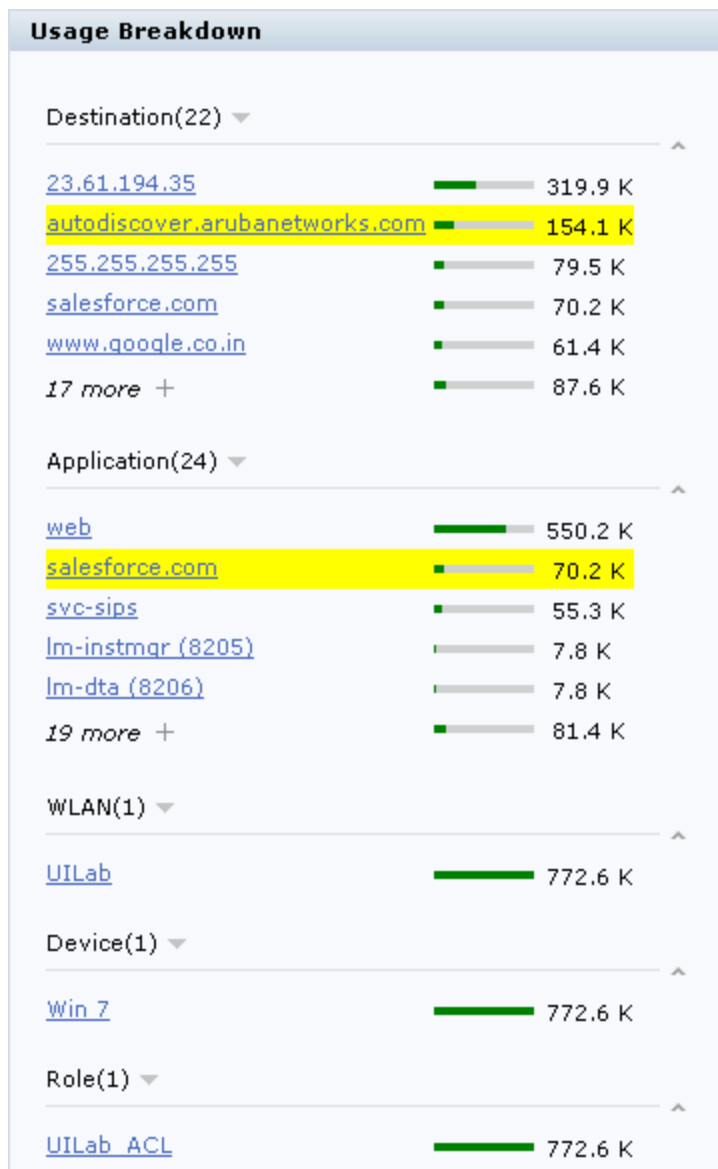

Aggregated Sessions

The Aggregated Sessions displays a list of all user and non-user sessions on the controller.

Figure 2c Aggregated Sessions

Aggregated Sessions (37)						
	Source IP	Destination Name/IP	IP Protocol	Application	Tx Bytes	Rx Bytes
→	10.16.22.89	au.download.windowsupdate.com	tcp	web	29.4 K	1.1 M
→	10.16.22.89	autodiscover.arubanetworks.com	tcp	web	67.1 K	135.5 K
→	10.16.22.83	10.16.22.28	tcp	unicall (4343)	38.2 K	148.3 K
→	10.16.22.89	sjclync02.arubanetworks.com	tcp	svc-sips	5.5 K	69.3 K
→	10.16.22.80	mail.google.com	tcp	gmail	6.2 K	2.1 K
→	10.16.22.80	apacd-01.arubanetworks.com	tcp	svc-microsoft-ds	3.9 K	1.2 K
→	10.16.22.89	umps2c2.salesforce.com	tcp	salesforce.com	3.4 K	724

Figure 2d *Aggregated Sessions (continued)*

User	Device	Role	WLAN	Destination Alias
10.16.22.89	Win 7	UILab_ACL	UILab	--
10.16.22.89	Win 7	UILab_ACL	UILab	--
10.16.22.83	Win 7	UILab_ACL	UILab	--
10.16.22.89	Win 7	UILab_ACL	UILab	--
10.16.22.80	Win 7	UILab_ACL	UILab	gmail
10.16.22.80	Win 7	UILab_ACL	UILab	--
10.16.22.89	Win 7	UILab_ACL	UILab	salesforce.com

See the following table for more information on **Aggregated Sessions** fields.

Table 247: *Aggregated Sessions Fields*

Column	Description
Source IP	Indicates the IP address of the wireless or wired user associated to the controller.
Destination Name/IP	Destination hostname, or IP address if hostname is not available.
IP Protocol	Type of IP protocol traffic. For example, TCP or UDP.
Application	Application name, protocols, and ports.
Tx Bytes	Total number of bytes transmitted in a session.
RX Bytes	Total number of bytes received in a session.
User	Indicates a wireless or wired user associated to the controller.
Device	Specifies the client device type.
Role	Determines the user's network privileges based on the assigned user role.
WLAN	The service set identifier (SSID) that uniquely identifies the WLAN.
Destination Alias	Fully Qualified Domain Name (FQDN) or the URL of the destination network or host.

You can perform the following tasks in the **Aggregated Sessions** section:

- **Sort:** Click a column header of the table to sort the list by column. You can also use the sort icon that appears when you click on a column.
- **Filter:** Click the filter icon on the first column and select the filter criterion to filter the entries.

Chapter 34

Management Access

This chapter describes management access and tasks for a user-centric network and includes the following topics:

- ["Configuring Certificate Authentication for WebUI Access" on page 625](#)
- ["Enabling Public Key Authentication for SSH Access" on page 626](#)
- ["Enabling RADIUS Server Authentication" on page 627](#)
- ["Implementing a Specific Management Password Policy" on page 632](#)
- ["Managing Certificates" on page 635](#)
- ["Configuring SNMP" on page 639](#)
- ["Configuring Logging" on page 640](#)
- ["Enabling Guest Provisioning" on page 643](#)
- ["Managing Files on the Controller" on page 657](#)
- ["Setting the System Clock" on page 660](#)

Configuring Certificate Authentication for WebUI Access

The controller supports client certificate authentication for users accessing the controller using the WebUI. (The default is for username/password authentication.) You can use client certificate authentication only, or client certificate authentication with username/password (if certificate authentication fails, the user can log in with a configured username and password).



NOTE: Each controller can support a maximum of ten management users.

To use client certificate authentication, you must do the following:

1. Obtain a client certificate and import the certificate into the controller. Obtaining and importing a client certificate is described in ["Managing Certificates" on page 635](#).
2. Configure certificate authentication for WebUI management. You can optionally also select username/password authentication.
3. Configure a user with a management role. Specify the client certificate for authentication of the user.

In the WebUI

1. Navigate to the **Configuration > Management > General** page.
2. Under WebUI Management Authentication Method, select Client Certificate. You can select Username and Password as well; in this case, the user is prompted to manually enter the username and password only if the client certificate is invalid.
3. Select the server certificate to be used for this service.
4. Click **Apply**.
5. To configure the management user, navigate to the **Configuration > Management > Administration** page.

- a. Under Management Users, click **Add**.
- b. Select Certificate Management.
- c. Select WebUI Certificate.
- d. Enter the username.
- e. Select the user role assigned to the user upon validation of the client certificate
- f. Enter the serial number for the client certificate.
- g. Select the name of the CA that issued the client certificate.
- h. Click **Apply**.

In the CLI

```
web-server
  mgmt-auth certificate
  switch-cert <certificate>
mgmt-user webui-cacert <ca> serial <number> <username> < role>
```

Enabling Public Key Authentication for SSH Access

The controller allows public key authentication of users accessing the controller using SSH. (The default is for username/password authentication.) When you import an X.509 client certificate into the controller, the certificate is converted to SSH-RSA keys. When you enable public key authentication for SSH, the controller validates the client's credentials with the imported public keys. You can specify public key authentication only, or public key authentication with username/password (if the public key authentication fails, the user can login with a configured username and password).

To use public key authentication, you must do the following:

1. Import the X.509 client certificate into the controller using the WebUI, as described in ["Importing Certificates" on page 637](#)
2. Configure SSH for client public key authentication. You can optionally also select username/password authentication.
3. Configure the username, role and client certificate.

In the WebUI

1. Navigate to the **Configuration > Management > General** page.
2. Under SSH (Secure Shell) Authentication Method, select Client Public Key. You can optionally select Username/Password to use both username/password and public key authentication for SSH access.
3. Click **Apply**.
4. To configure the user, navigate to the **Configuration > Management > Administration** page.
 - a. Under Management Users, click **Add**.
 - b. Select Certificate Management.
 - c. Select SSH Public Key.



NOTE: ArubaOS recommends that the username and role for SSH be the same as for the WebUI Certificate. You can optionally use the checkbox to copy the username and role from the Web Certificate section to the SSH Public Key section.

- d. Enter the username.
- e. Select the management role assigned to the user upon validation of the client certificate.

- f. Select the client certificate.
- g. Click **Apply**.

In the CLI

```
ssh mgmt-auth public-key [username/password]
mgmt-user ssh-pubkey client-cert <certificate> <username> <role>
```

Enabling RADIUS Server Authentication

This section include many different types of RADIUS server configuration and related procedures.

Configuring RADIUS Server Username and Password Authentication

In this example, an external RADIUS server is used to authenticate management users. Upon authentication, users are assigned the default role root.

In the WebUI

1. Navigate to the **Configuration > Security > Authentication > Servers** page.
2. Select **RADIUS Server** to display the Radius Server List.
 - a. To configure a RADIUS server, enter the name for the server (for example, rad1) and click **Add**.
 - b. Select the name to configure server parameters, such as IP address. Select the **Mode** checkbox to activate the server.
 - c. Click **Apply**.
3. Select **Server Group** to display the Server Group list.
 - a. Enter the name of the new server group (for example, corp_rad) and click **Add**.
 - b. Select the name to configure the server group.
 - c. Under Servers, click **New** to add a server to the group.
 - d. Select a server from the drop-down menu and click **Add Server**.
 - e. Click **Apply**.
4. Navigate to the **Configuration > Management > Administration** page.
 - a. Under Management Authentication Servers, select a management role (for example, root) for the Default Role.
 - b. Select (check) Mode.
 - c. For Server Group, select the server group that you just configured.
 - d. Click **Apply**.

In the CLI

```
aaa authentication-server radius rad1
  host <ipaddr>
  enable
```

```
aaa server-group corp_rad
  auth-server rad1
```

```
aaa authentication mgmt
  default-role root
  enable
  server-group corp_rad
```

Configuring RADIUS Server Authentication with VSA

In this scenario, an external RADIUS server authenticates management users and returns to the controller the Dell vendor-specific attribute (VSA) called Dell-Admin-Role that contains the name of the management role for the user. The authenticated user is placed into the management role specified by the VSA.

The controller configuration is identical to the ["Configuring RADIUS Server Username and Password Authentication" on page 627](#). The only difference is the configuration of the VSA on the RADIUS server. Ensure that the value of the VSA returned by the RADIUS server is one of the predefined management roles. Otherwise, the user will have *no* access to the controller.

Configuring RADIUS Server Authentication with Server Derivation Rule



NOTE: Dell controllers do not make use of any returned attributes from a TACACS+ server.

A RADIUS server can return to the controller a standard RADIUS attribute that contains one of the following values:

- The name of the management role for the user
- A value from which a management role can be derived

For either situation, configure a server-derivation rule for the server group.

In the following example, the RADIUS server returns the attribute Class to the controller. The value of the attribute can be either “root” or “network-operations” depending upon the user; the returned value is the role granted to the user.



NOTE: Ensure that the value of the attribute returned by the RADIUS server is one of the predefined management roles. Otherwise, the management user will not be granted access to the controller.

In the WebUI

1. Navigate to the **Configuration > Security > Authentication > Servers** page.
2. Select **RADIUS Server** to display the Radius Server List.
 - a. To configure a RADIUS server, enter the name for the server (for example, rad1) and click **Add**.
 - b. Select the name to configure server parameters, such as IP address. Select the **Mode** checkbox to activate the server.
 - c. Click **Apply**.
3. Select **Server Group** to display the Server Group list.
 - a. Enter the name of the new server group (for example, corp_rad) and click **Add**.
 - b. Select the name to configure the server group.
 - c. Under Servers, click **New** to add a server to the group.
 - d. Select a server from the drop-down menu and click **Add Server**.
 - e. Under Server Rules, click **New** to add a server rule.
 - f. For Condition, select **Class** from the scrolling list. Select **value-of** from the drop-down menu. Select **Set Role** from the drop-down menu.
 - g. Click **Add**.
 - h. Click **Apply**.
4. Navigate to the **Configuration > Management > Administration** page.

- a. Under Management Authentication Servers, select a management role (for example, read-only) for the Default Role.
- b. Select (check) Mode.
- c. For Server Group, select the server group that you just configured.
- d. Click **Apply**.

In the CLI

```

aaa authentication-server radius rad1
    host <ipaddr>
    enable

aaa server-group corp_rad
    auth-server rad1
    set role condition Class value-of

aaa authentication mgmt
    default-role read-only
    enable
    server-group corp_rad

```

In the following example, the RADIUS server returns the attribute Class to the controller; the value of this attribute can be “it”, in which case, the user is granted the root role. If the value of the Class attribute is anything else, the user is granted the default read-only role.

Configuring a set-value server-derivation rule

In the WebUI

1. Navigate to the **Configuration > Security > Authentication > Servers** page.
2. Select **RADIUS Server** to display the Radius Server List.
 - a. To configure a RADIUS server, enter the name for the server (for example, rad1) and click **Add**.
 - b. Select the name to configure server parameters, such as IP address. Select the **Mode** checkbox to activate the server.
 - c. Click **Apply**.
3. Select **Server Group** to display the Server Group list.
 - a. Enter the name of the new server group (for example, corp_rad) and click **Add**.
 - b. Select the name to configure the server group.
 - c. Under Servers, click **New** to add a server to the group.
 - d. Select a server from the drop-down menu and click **Add Server**.
 - e. Under Server Rules, click **New** to add a server rule.
 - f. For Condition, select **Class** from the scrolling list. Select **equals** from the drop-down menu. Enter **it**. Select **Set Role** from the drop-down menu. For Value, select **root** from the drop-down menu.
 - g. Click **Add**.
 - h. Click **Apply**.
4. Navigate to the **Configuration > Management > Administration** page.
 - a. Under Management Authentication Servers, select a management role (for example, read-only) for the Default Role.
 - b. Select (check) Mode.
 - c. For Server Group, select the server group that you just configured.

- d. Click **Apply**.

In the CLI

```
aaa authentication-server radius rad1
  host <ipaddr>
  enable

aaa server-group corp_rad
  auth-server rad1
  set role condition Class equals it set-value root

aaa authentication mgmt
  default-role read-only
  enable
  server-group corp_rad
```

For more information about configuring server-derivation rules, see ["Configuring Server-Derivation Rules" on page 182](#).

Disabling Authentication of Local Management User Accounts

You can disable authentication of management user accounts in local switches if the configured authentication server(s) (RADIUS or TACACS+) are not available.

You can disable authentication of management users based on the results returned by the authentication server. When configured, locally-defined management accounts (for example, admin) are not allowed to log in if the server (s) are reachable and the user entry is not found in the authentication server. In this situation, if the RADIUS or TACACS+ server is unreachable, meaning it does not receive a response during authentication, or fails to authenticate a user because of a timeout, local authentication is used and you can log in with a locally-defined management account.

In the WebUI

1. Navigate to the **Configuration > Management > Administration** page.
2. Under Management Authentication Servers, uncheck the **Local Authentication Mode** checkbox.
3. Click **Apply**.

In the CLI

```
mgmt-user localauth-disable
```

Verifying the configuration

To verify if authentication of local management user accounts is enabled or disabled, use the following command:

```
show mgmt-user local-authentication-mode
```

Resetting the Admin or Enable Password

This section describes how to reset the password for the default administrator user account (**admin**) on the controller. Use this procedure if the administrator user account password is lost or forgotten.

1. Connect a local console to the serial port on the controller.
2. From the console, log in the controller using the username **password** and the password **forgetme!**.
3. Enter enable mode by typing in **enable**, followed by the password **enable**.
4. Enter configuration mode by typing in **configure terminal**.

5. To configure the administrator user account, enter **mgmt-user admin root**. Enter a new password for this account. Retype the same password to confirm.
6. Exit from the configuration mode, enable mode, and user mode.

This procedure also resets the enable mode password to **enable**. If you have defined a management user password policy, make sure that the new password conforms to this policy. For details, see ["Implementing a Specific Management Password Policy" on page 632](#).

[Figure 248](#) is an example of how to reset the password. The commands in bold type are what you enter.

Figure 248: Resetting the Password

```
(host)
User: password
Password : forgetme!
(host) >enable
Password : enable
(host) #configure terminal
Enter Configuration commands, one per line. End with CNTL/Z

(host) (config) #mgmt-user admin root
Password : *****
Re-Type password : *****
(host) (config) #exit
(host) #exit
(host) >exit
```

After you reset the administrator user account and password, you can login to the controller and reconfigure the enable mode password. To do this, enter configuration mode and type the **enable secret** command. You are prompted to enter a new password and retype it to confirm. Save the configuration by entering **write memory**.

[Figure 249](#) details an example reconfigure the enable mode password. Again, the command you enter displays in bold type.

Figure 249: Reconfigure the enable mode password

```
User: admin
Password : *****
(host) >enable
Password : *****
(host) #configure terminal
Enter Configuration commands, one per line. End with CNTL/Z

(host) (config) #enable secret
Password : *****
Re-Type password : *****
(host) (config) #write memory
```

Bypassing the Enable Password Prompt

The `bypass enable` feature lets you bypass the enable password prompt and go directly to the privileged commands (config mode) after logging on to the controller. This is useful if you want to avoid changing the enable password due to company policy.

Use the `enable bypass` CLI command to bypass the enable prompt and go directly to the privileged commands (config mode). Use the `no enable bypass` CLI command to restore the enable password prompt.

Setting an Administrator Session Timeout

You can configure the number of seconds after which an Administrator's WebUI or CLI session times out.

In the WebUI

To define a timeout interval for a WebUI session, use the command:

```
web-server sessiontimeout <session-timeout>
```

In the above command, <session-timeout> can be any number of seconds from 30 to 3600, inclusive.

In the CLI

To define a timeout interval for a CLI session, use the command:

```
loginsession timeout <value>
```

In the above command, <val> can be any number of minutes from 5 to 60 or seconds from 1 to 3600, inclusive. You can also specify a timeout value of 0 to disable CLI session timeouts.

Implementing a Specific Management Password Policy

By default, the password for a new management user has no requirements other than a minimum length of 6 alphanumeric or special characters. However, if your company enforces a best practices password policy for management users with root access to network equipment, you may want to configure a password policy that sets requirements for management user passwords.

Defining a Management Password Policy

To define specific management password policy settings through the WebUI or the CLI, complete the following steps:

In the WebUI

1. Navigate to **Configuration > All Profiles**.
2. Expand **Other Profiles**.
3. Select **Mgmt Password Policy**.
4. Configure the settings described in [Table 250](#).

Table 250: Management Password Policy Settings

Parameter	Description
Enable Password Policy	Select this checkbox to enable the password management policy. The password policy will not be enforced until this checkbox is selected.
Minimum password length required	The minimum number of characters required for a management user password Range: 6-64 characters. Default: 6.
Minimum number of Upper Case characters	The minimum number of uppercase characters required in a management user password. Range: 0-10 characters. By default, there is no requirement for uppercase letters in a password, and the parameter has a default value of 0.
Minimum number of Lower Case characters	The minimum number of lowercase characters required in a management user password.

Parameter	Description
	Range: 0-10 characters. By default, there is no requirement for lowercase letters in a password, and the parameter has a default value of 0.
Minimum number of Digits	The minimum number of numeric digits required in a management user password. Range: 0-10 digits. By default, there is no requirement for numerical digits in a password, and the parameter has a default value of 0.
Username or Reverse of username NOT in Password	When you select this checkbox, the password cannot be the management users' current username or the username spelled backwards.
Maximum Number of failed attempts in 3 minute window to lockout user	The number of failed attempts within a 3 minute window that causes the user to be locked out for the period of time specified by the Time duration to lockout the user upon crossing the "lock-out" threshold parameter. Range: 0-10 attempts. By default, the password lockout feature is disabled, and the default value of this parameter is 0 attempts.
Maximum consecutive character repeats	The maximum number of consecutive repeating characters allowed in a management user password. Range: 0-10 characters. By default, there is no limitation on the numbers of character that can repeat within a password, and the parameter has a default value of 0 characters.

5. Click **Apply** to save your settings.

The table below describes the characters allowed in a management user password. The disallowed characters cannot be used by any management user password, even if the password policy is disabled.

Table 251: *Allowed Characters in a Management User Password*

Allowed Characters	Disallowed Characters
exclamation point: !	Parenthesis: ()
underscore: _	apostrophe: '
at symbol: @	semi-colon: ;
pound sign: #	dash: -
dollar sign: \$	equals sign: =
percent sign: %	slash: /
caret: ^	question mark: ?
ampersand: &	
star: *	
greater and less than symbols: < >	
curled braces: { }	
straight braces: []	

Allowed Characters	Disallowed Characters
colon :	
period: .	
pipe:	
plus sign: +	
tilde: ~	
comma: ,	
accent mark: `	

In the CLI

```

aaa password-policy mgmt
  enable
  no
  password-lock-out
  password-lock-out-time
  password-max-character-repeat.
  password-min-digit
  password-min-length
  password-min-lowercase-characters
  password-min-special-character
  password-min-uppercase-characters
  password-not-username

```

Management Authentication Profile Parameters

Table 252 describes configuration parameters on the Management Authentication profile page.



NOTE: In the CLI, you configure these options with the `aaa authentication mgmt` and `aaa-server-group` commands.

Table 252: Management Authentication Profile Parameters

Parameter	Description
Enable	Enables authentication for administrative users.
Default Role	Select a predefined management role to assign to authenticated administrative users:
Root	Default superuser role
guest-provisioning	Guest provisioning role
location-api-mgmt	Location API role
network-operations	Network operations role

Parameter	Description
no-access	No commands are accessible for this role
read-only	Read-only role
no access	Negates any configured parameter.
Server Group	Name of the group of servers used to authenticate administrative users. See the CLI command <code>aaa-server-group</code> , in the <i>CLI Command Reference Guide</i> for more information.

Managing Certificates

The controller is designed to provide secure services through the use of digital certificates. Certificates provide security when authenticating users and computers and eliminate the need for less secure password-based authentication.

There is a *default* server certificate installed in the controller to demonstrate the authentication of the controller for captive portal and WebUI management access. However, this certificate does not guarantee security in production networks. Dell *strongly* recommends that you replace the default certificate with a custom certificate issued for your site or domain by a trusted Certificate Authority (CA). This section describes how to generate a Certificate Signing Request (CSR) to submit to a CA and how to import the signed certificate received from the CA into the controller.

The controller supports client authentication using digital certificates for specific user-centric network services, such as AAA FastConnect, VPN (see [Virtual Private Networks on page 271](#)), and WebUI and SSH management access. Each service can employ different sets of client and server certificates.

During certificate-based authentication, the controller provides its server certificate to the client for authentication. After validating the controller's server certificate, the client presents its own certificate to the controller for authentication. To validate the client certificate, the controller checks the certificate revocation list (CRL) maintained by the CA that issued the client certificate. After validating the client's certificate, the controller can check the user name in the certificate with the configured authentication server (this action is optional and configurable).

About Digital Certificates

Clients and the servers to which they connect may hold authentication certificates that validate their identities. When a client connects to a server for the first time, or the first time since its previous certificate has expired or been revoked, the server requests that the client transmit its authentication certificate. The client's certificate is then verified against the CA which issued it. Clients can also request and verify the server's authentication certificate. For some applications, such as 802.1x authentication, clients do not need to validate the server certificate for the authentication to function.

Digital certificates are issued by a CA which can be either a commercial, third-party company or a private CA controlled by your organization. The CA is trusted to authenticate the owner of the certificate before issuing a certificate. A CA-signed certificate guarantees the identity of the certificate holder. This is done by comparing the digital signature on a client or server certificate to the signature on the certificate for the CA. When CA-signed certificates are used to authenticate clients, the controller checks the validity of client certificates using certificate revocation lists (CRLs) maintained by the CA that issued the certificate.

Digital certificates employ public key infrastructure (PKI), which requires a private-public key pair. A digital certificate is associated with a private key, known only to the certificate owner, and a public key. A certificate

encrypted with a private key is decrypted with its public key. For example, party A encrypts its certificate with its private key and sends it to party B. Party B decrypts the certificate with party A's public key.

Obtaining a Server Certificate

Best practices is to replace the default server certificate in the controller with a custom certificate issued for your site or domain by a trusted CA. To obtain a security certificate for the controller from a CA:

1. Generate a Certificate Signing Request (CSR) on the controller using either the WebUI or CLI.
2. Submit the CSR to a CA. Copy and paste the output of the CSR into an email and send it to the CA of your choice.
3. The CA returns a signed server certificate and the CA's certificate and public key.
4. Install the server certificate, as described in ["Importing Certificates" on page 637](#).



NOTE: There can be only one outstanding CSR at a time in the controller. Once you generate a CSR, you need to import the CA-signed certificate into the controller before you can generate another CSR.

In the WebUI

1. Navigate to the **Configuration > Management > Certificates > CSR** page.
2. Enter the following information:

Table 253: CSR Parameters

Parameter	Description	Range
CSR Type	Type of the CSR. You can generate a certificate signing request either with an Elliptic curve (EC) key, or with a Rivest-Shamir-Aldeman (RSA) key.	ec/rsa
Curve name	Length of the private/public key for ECDSA. This is applicable only if CSR Type is ec.	secp256r1/secp384r1
Key Length	Length of the private/public key for RSA. This is applicable only if CSR Type is rsa.	1024/2048/4096
Common Name	Typically, this is the host and domain name, as in www.yourcompany.com.	—
Country	Two-letter ISO country code for the country in which your organization is located.	
State/Province	State, province, region, or territory in which your organization is located.	
City	City in which your organization is located.	
Organization	Name of your organization.	
Unit	Optional field to distinguish a department or other unit within your organization.	
Email Address	Email address referenced in the CSR.	

3. Click **Generate New**.

4. Click **View Current** to display the generated CSR. Select and copy the CSR output between the BEGIN CERTIFICATE REQUEST and END CERTIFICATE REQUEST lines, paste it into an email and send it to the CA of your choice.

In the CLI

1. Run the following command:

```
crypto pki csr {rsa key_len <key_val> |{ec curve-name <key_val>}} common_name <common_val>  
country <country_val> state_or_province <state> city <city_val> organization  
<organization_val> unit <unit_val> email <email_val>
```
2. Display the CSR output with the following command:

```
show crypto pki csr
```
3. Copy the CSR output between the BEGIN CERTIFICATE REQUEST and END CERTIFICATE REQUEST lines, paste it into an email and send it to the CA of your choice.

Obtaining a Client Certificate

You can use the CSR generated on the controller to obtain a certificate for a client. However, since there may be a large number of clients in a network, you typically obtain client certificates from a corporate CA server. For example, in a browser window, enter `http://<ipaddr>/crtserv`, where <ipaddr> is the IP address of the CA server.

Importing Certificates

Use the WebUI or the CLI to import certificates into the controller.



NOTE: You cannot export certificates from the controller.

You can import the following types of certificates into the controller:

- Server certificate signed by a trusted CA. This includes a public and private key pair.
- CA certificate used to validate other server or client certificates. This includes only the public key for the certificate.
- Client certificate and client's public key. (The public key is used for applications such as SSH which does not support X509 certificates and requires the public key to verify an allowed certificate.)

Certificates can be in the following formats:

- X509 PEM unencrypted
- X509 PEM encrypted with a key
- DER
- PKCS7 encrypted
- PKCS12 encrypted

In the WebUI

1. Navigate to the **Configuration > Management > Certificates > Upload** page.
2. For Certificate Name, enter a user-defined name.
3. For Certificate Filename, click **Browse** to navigate to the appropriate file on your computer.
4. If the certificate is encrypted, enter the passphrase.
5. Select the Certificate Format from the drop-down menu.
6. Select the Certificate Type from the drop-down menu.
7. Click **Upload** to install the certificate in the controller.

In the CLI

Use the following command to import CSR certificates:

```
crypto pki-import {der|pem|pfx|pkcs12|pkcs7} {PublicCert|ServerCert|TrustedCA} <name>
```

The following example imports a server certificate named `cert_20` in DER format:

```
crypto pki-import der ServerCert cert_20
```

Viewing Certificate Information

In the WebUI, the Certificate Lists section of the page lists the certificates that are currently installed in the controller. Click **View** to display the contents of a certificate.

To view the contents of a certificate with the CLI, use the following commands:

Table 254: *Certificate Show Commands*

Command	Description
<pre>show crypto-local pki trustedCAs [<name>]< [attribute>]</pre>	Displays the contents of a trusted CA certificate. If a name is not specified, all CA certificates imported into the controller are displayed. If name and attribute are specified, then only the attribute in the certificate are displayed. Attributes can be CN, validity, serial-number, issuer, subject, public-key.
<pre>show crypto-local pki serverCerts [<name>] [<attribute>]</pre>	Displays the contents of a server certificate. If a name is not specified, all server certificates imported into the controller are displayed.
<pre>show crypto-local pki publiccert [<name>] [<attribute>]</pre>	Displays the contents of a public certificate. If a name is not specified, all public certificates imported into the controller are displayed.

Imported Certificate Locations

Imported certificates and keys are stored in the following locations in flash on the controller:

Table 255: *Imported Certificate Locations*

Location	Description
<code>/flash/certmgr/trustedCAs</code>	Trusted CA certificates, either for root or intermediate CAs. Best practices is to import the certificate for an intermediate CA, you also import the certificate for the signing CA.
<code>/flash/certmgr/serverCerts</code>	Server certificates. These certificates must contain both a public and private key (the public and private key must match). You can import certificates in PKCS12 and X509 PEM formats, but they are stored in X509 PEM DES encrypted format.
<code>/flash/certmgr/CSR</code>	Temporary certificate signing requests (CSRs) that have been generated on the controller and are awaiting a CA to sign them.
<code>/flash/certmgr/publiccert</code>	Public key of certificates. This allows a service on the controller to identify a certificate as an allowed certificate.

Checking CRLs

A CA maintains a CRL that contains a list of certificates that have been revoked before their expiration date. Expired client certificates are not accepted for any user-centric network service. Certificates may be revoked because certificate key has been compromised or the user specified in the certificate is no longer authorized to use the key.

When a client certificate is being authenticated for a user-centric network service, the controller checks with the appropriate CA to make sure that the certificate has not been revoked.



NOTE: The controller does not support download of CRLs.

Configuring SNMP

Dell controllers support versions 1, 2c, and 3 of Simple Network Management Protocol (SNMP) for reporting purposes only. In other words, SNMP cannot be used for setting values in a Dell system in the current ArubaOS version.



NOTE: Dell-specific management information bases (MIBs) describe the objects that can be managed using SNMP. See the *Dell PowerConnect W-Series ArubaOS MIB Reference Guide* for information about the Dell MIBs and SNMP traps.

SNMP Parameters for the Controller

You can configure the following SNMP parameters for the controller.

Table 256: *SNMP Parameters for the Controller*

Field	Description
Host Name	Host name of the controller.
System Contact	Name of the person who acts as the System Contact or administrator for the controller.
System Location	String to describe the location of the controller.
Read Community Strings	Community strings used to authenticate requests for SNMP versions before version 3. NOTE: This is needed only if using SNMP v2c and is not needed if using version 3.
Enable Trap Generation	Enables generation of SNMP traps to configured SNMP trap receivers. Refer to the list of traps in the “SNMP traps” section below for a list of traps that are generated by the controller.
Trap receivers	Host information about a trap receiver. This host needs to be running a trap receiver to receive and interpret the traps sent by the Dell controller. Configure the following for each host/trap receiver: <ul style="list-style-type: none">● IP address● SNMP version: can be 1, 2c, or 3.● Type: Trap or Inform (SNMPv2c or SNMPv3 only)● Engine ID: (SNMPv3 only)● Security string● UDP port on which the trap receiver is listening for traps. The default is the UDP port number 162. This is optional, and will use the default port number if not modified by the user.

Field	Description
If you are using SNMPv3 to obtain values from the controller, you can configure the following parameters:	
User name	A string representing the name of the user.
Authentication protocol	An indication of whether messages sent on behalf of this user can be authenticated, and if so, the type of authentication protocol used. This can take one of the two values: <ul style="list-style-type: none"> MD5: HMAC-MD5-96 Digest Authentication Protocol SHA: HMAC-SHA-96 Digest Authentication Protocol
Authentication protocol password	If messages sent on behalf of this user can be authenticated, the (private) authentication key for use with the authentication protocol. This is a string password for MD5 or SHA depending on the choice above.
Privacy protocol	An indication of whether messages sent on behalf of this user can be protected from disclosure, and if so, the type of privacy protocol which is used. This takes the value DES (CBC-DES Symmetric Encryption Protocol).
Privacy protocol password	If messages sent on behalf of this user can be encrypted/decrypted with DES, the (private) privacy key for use with the privacy protocol.

Follow the steps below to configure a controller's basic SNMP parameters.

In the WebUI

1. Navigate to the **Configuration > Management > SNMP** page.
2. If the controller will be sending SNMP traps, click **Add** in the Trap Receivers section to add a trap receiver.
3. If you are using SNMPv3 to obtain values from the controller, click **Add** in the SNMPv3 Users section to add a new SNMPv3 user.
4. Click **Apply**.

In the CLI

```
hostname name
syscontact name
syslocation string
snmp-server community string
snmp-server enable trap
snmp-server engine-id engine-id
snmp-server host ipaddr version {1|2c|3} string [udp-port number]
snmp-server trap source ipaddr
snmp-server user name [auth-prot {md5|sha} password priv-prot DES password
```



NOTE: Earlier versions of ArubaOS supported SNMP on individual APs. This feature is not supported by this version of ArubaOS.

Configuring Logging

This section outlines the steps required to configure logging on a controller. For each category or subcategory of message, you can set the logging level or severity level of the messages to be logged. [Table 257](#) summarizes these categories:

Table 257: Software Modules

Category/Subcategory	Description
Network	Network messages
all	All network messages
packet-dump	Protocol packet dump messages
mobility	Mobility messages
dhcp	DHCP messages
System	System messages
all	All system messages
configuration	Configuration messages
messages	Messages
snmp	SNMP messages
webserver	Web server messages
security	Security messages
all	All security messages
aaa	AAA messages
firewall	Firewall messages
packet-trace	Packet trace messages
mobility	Mobility messages
vpn	VPN messages
dot1x	802.1x messages
ike	IKE messages
webserver	Web server messages
Wireless	Wireless messages
all	All wireless messages
User	User messages
all	All user messages
captive-portal	Captive portal user messages
vpn	VPN messages

Category/Subcategory	Description
dot1x	802.1x messages
radius	RADIUS user messages

For each category or subcategory, you can configure a logging level. [Table 258](#) describes the logging levels in order of severity, from most to least severe.

Table 258: Logging Levels

Logging Level	Description
Emergency	Panic conditions that occur when the system becomes unusable.
Alert	Any condition requiring immediate attention and correction.
Critical	Any critical conditions such as a hard drive error.
Errors	Error conditions.
Warning	Warning messages.
Notice	Significant events of a non-critical and normal nature.
Informational	Messages of general interest to system users.
Debug	Messages containing information useful for debugging.

The default logging level for all categories is Warning. You can also configure IP address of a syslog server to which the controller can direct these logs.

In the WebUI

1. Navigate to the **Configuration > Management > Logging > Servers** page.
2. To add a logging server, click **New** in the Logging Servers section.
3. Click **Add** to add the logging server to the list of logging servers. Ensure that the syslog server is enabled and configured on this host. Click **Apply**.
4. To select the types of messages you want to log, select the **Levels** tab.
5. Select the category or subcategory to be logged.
6. To select the severity level for the category or subcategory, scroll to the bottom of the page. Select the level from the Logging Level drop-down menu. Click **Done**.
7. Click **Apply** to apply the configuration.

In the CLI

```
logging <ipaddr>
logging level <level> <category> [subcat <subcategory>]
```

Enabling Guest Provisioning

The Guest Provisioning feature lets you manage guests who need access to your company's wireless network. This section describes how to:

- Design and configure the Guest Provisioning page – Using the WebUI, the network administrator designs and configures the Guest Provisioning page that is used to create a guest account.
- Configure a guest provisioning user – The network administrator configures one or more guest provisioning users. A guest provisioning user, such as a front desk receptionist, signs in guests at your company.
- Using the Guest Provisioning page – The Guest Provisioning page is used by the guest provisioning user to create guest accounts for people who are visiting your company.

Configuring the Guest Provisioning Page

Use the Guest Provisioning Configuration page to create the Guest Provisioning page. This configuration page consists of three tabs: Guest Fields, Page Design and Email. You configure the information on all three tabs to create a Guest Provisioning page.

- Guest Fields tab—lets you select the fields that appear on the Guest Provisioning page.
- Page Design tab—lets you specify the company banner, heading, and text and background colors that appear on the Guest Provisioning page.
- Email tab—lets you specify an email to be sent to the guest or sponsor (or both). Email messages can be sent automatically at account creation time and also may be sent manually by the administrator from the Guest Provisioning page.

In the WebUI



NOTE: You can only create and design the Guest Provisioning page in the WebUI.

This section describes how to design a Guest Provisioning page using all three tabs.

Configuring the Guest Fields

1. Navigate to the **Configuration > Management > Guest Provisioning** page. The Guest Provisioning configuration page displays with the Guest Fields tab on top. This tab contains the following columns:
 - Internal Name—The unique identifier that is mapped to the label in the UI.
 - Label in UI—A customizable string that displays in both the main listing pane and details sheet on the Guest Provisioning page.
 - Display in Details—Fields with selected checkboxes appear in the Show Details popup-window.



NOTE: If the `guest_category`, `account_category`, `sponsor_category` and `optional_category` fields are not checked, their respective sections do not appear on the Guest Provisioning page.

- Display in Listing—Fields with selected checkboxes appear as columns in the management user summary page.

Figure 259: Guest Provisioning Configuration Page—Guest Fields Tab

Management > Guest Provisioning

Guest Fields | Page Design | Email

Specify the fields you wish to appear on the Guest Provisioning Page. [Help](#)

Field	Internal Name	Label in UI	Display In	
			Details	Listing
guest_category		Guest	<input checked="" type="checkbox"/>	
guest_username		Username	<input checked="" type="checkbox"/>	<input checked="" type="checkbox"/>
guest_password		Password	<input checked="" type="checkbox"/>	
guest_fullname		Full name	<input type="checkbox"/>	
guest_company		Company	<input checked="" type="checkbox"/>	<input checked="" type="checkbox"/>
guest_email		Email	<input checked="" type="checkbox"/>	<input type="checkbox"/>
guest_phone		Phone	<input checked="" type="checkbox"/>	<input type="checkbox"/>
comments		Comments	<input checked="" type="checkbox"/>	<input type="checkbox"/>
account_category		Account	<input checked="" type="checkbox"/>	
creation_date		Created	<input checked="" type="checkbox"/>	<input type="checkbox"/>
start_date		Start	<input checked="" type="checkbox"/>	<input checked="" type="checkbox"/>

2. Select the checkbox next to each field, described in [Table 260](#), that you want to appear on the Guest Provisioning page. Optionally, you can customize the label that displays in the UI.
3. Click **Preview Current Settings** to view what the Guest Provisioning page looks like while you are designing it.
4. To save changes, click **Apply**.



NOTE: Best practices is to check the **Display in Listing** field for only the most essential fields, so that the Guest Provisioning user does not have to scroll the guest listing horizontally to see all the columns.

Table 260: Guest Provisioning—Guest Field Descriptions

Guest Field	Description
guest_category	A guest is the person who needs guest access to the company's wireless network. This is the label on the Guest Provisioning page for the guest information.
guest_username	Username for the guest.
guest_password	Password for the guest. (Must contain at least 1-6 characters and at least one digit.)
guest_fullname	Full name of the guest.
guest_company	Name of the guest's company.

Guest Field	Description
guest_email	Guest's Email address.
guest_phone	Guest's phone number
comments	Optional comments about the guest's account status, meeting schedule and so on.
account_category	This is the label on the Guest Provisioning page for the account information.
creation-date	Date the account is created.
start_date	Date the guest account begins.
end_date	Date the guest account ends.
grantor	The username of the person of who created the guest account.
grantor_role	The authentication role of the grantor.
sponsor_category	A sponsor is the guest's primary contact for the visit. This is the label in the Guest Provisioning page for the sponsor information.
sponsor_username	
	Sponsor's work department
sponsor_email	Sponsor's Email address.
optional_category	This is the label in the Guest Provisioning page for the information in the optional fields that follow. NOTE: The optional_category field can be used for another person, for example a "Supervisor." You can enter username, full name, department and Email information into the optional fields. Or, you can use this category for some other purpose.
optional_field_1	optional_field_1 description
optional_field_2	optional_field_2 description
optional_field_3	optional_field_2 description
optional_field_4	optional_field_2 description

Configuring the Page Design

The Page Design tab lets you specify the company banner, heading, and text and background colors that appear on the Guest Provisioning page.

1. Navigate to the **Configuration > Management > Guest Provisioning** page and select the **Page Design** tab.

Figure 261: Guest Provisioning Configuration Page—Page Design Tab

Help'. A 'Banner:' section with a text input field and a 'Browse...' button. A 'Text:' section with a text input field containing 'Guests'. A 'Text Color:' section with a text input field containing '000000' and a color swatch, with '(RGB-6 Hex digits)' to the right. A 'Background color:' section with a text input field containing 'b0d2eb' and a color swatch, with '(RGB-6 Hex digits)' to the right."/>

Management > Guest Provisioning

Guest Fields Page Design Email

Specify the logo and colors for Guest Provisioning Page. [Help](#)

Banner:

Browse...

Text:

Text Color:

(RGB-6 Hex digits)

Background color:

(RGB-6 Hex digits)

2. Enter the filename which contains the company banner in the **Banner** field. Or, click **Browse** to search for the filename



NOTE: Best practices is to use a logo or banner image that is 600 x 100 pixels (width x height). The WebUI does not apply the size restrictions when you upload an image file, but the image is resized to 600 x 100 pixels when it displays or is printed.

3. Enter the label for the guest listing (the one you used in the Guest Fields tab) in the **Text** field.
4. Enter the hex value for the color of the text in the **Text Color** field. The text in the header of the guest listing displays in this color.
5. Enter the hex value for the color of the background in the **Background color** field. This determines the color of the header of the guest listing.
6. Click **Preview Current Settings** to preview the Guest Provisioning page while you are designing it.
7. To save changes, click **Apply**.

Configuring Email Messages

You can specify an email to be sent to the guest or sponsor (or both). Email messages can be sent automatically at account creation time or sent manually by the network administrator or guest provisioning user from the Guest Provisioning page at any time.

1. Specify the SMTP server and port that processes the guest provisioning (also known as guest access) email. You can complete this step using the WebUI or CLI commands:
 - ["Configuring the SMTP Server and Port in the WebUI" on page 646](#)
 - ["Configuring an SMTP server and port in the CLI" on page 647](#)
2. Create the email messages. Complete this step using the WebUI:
["Creating Email Messages in the WebUI" on page 647](#)

Configuring the SMTP Server and Port in the WebUI

1. Navigate to the Configuration > Management > SMTPpage.

2. Enter the IP address of the SMTP server to which the controller sends the guest provisioning email in the **IP Address of SMTP** server field.
3. Enter the number of the port through which the guest provisioning email passes in the **Port** field.
4. Click **Apply** and then **Save Configuration**.

Configuring an SMTP server and port in the CLI

The following command creates a guest-access email and sends guest user email through SMTP server IP address 1.1.1.1 on port 25.

```
(host) (config) #guest-access-email
(host) (Guest-access Email) #
(host) (Guest-access Email) #smtp-port 25
(host) (Guest-access Email) #smtp-server 1.1.1.1
```

Creating Email Messages in the WebUI

After you configured the SMTP server and port, follow these steps:

1. Navigate to the **Configuration > Management > Guest Provisioning** page and select the **Email** tab.

Figure 262: Guest Provisioning Configuration Page—Email Tab

The screenshot shows the 'Management > Guest Provisioning' page with the 'Email' tab selected. It features two columns for configuring email messages:

- Guest Message:**
 - Subject: Guest account information
 - From: guest_admin@arubanetwork.com
 - Body: A guest account has been created for your use. The **username**, password and valid dates for the account are given below.
 - Send automatically at account creation time
- Sponsor Message:**
 - Subject: Guest account information
 - From: sponsor_admin@arubanetworks.com
 - Body: You are listed as the Sponsor for the following guest account.
 - Send automatically at account creation time

2. To create a message for a guest or sponsor, customize the text in the **Subject**, **From** and **Body** fields as needed for both the Guest message and Sponsor message.
3. Optionally, select the **Send automatically at account creation time** checkbox when you want an email message to be sent to the guest and/or sponsor alerting them that a guest account has just been created.



NOTE: Regardless of whether you select this option, the person responsible for managing the Guest Provisioning page may choose to send this email message manually at any time.

Figure 263 shows a sample email message that is sent to the guest after the guest account is created.

Figure 263: Sample Guest Account Email – Sent to Sponsor

```
Sent: Monday, February 09, 2009 12:59 PM
To: John Smith
Subject: Guest account information

A guest account has been created for your use. The username, password and
valid dates for the account are given below.
=====
Username:  guest3518444
Password:  hqtehjcl936850
Guest Name:
Guest Company:  MyCompany
Guest Email:  JSmith@MyCompany.com
Guest Phone:
Sponsor Email:  DJones@AcmeCompany.com
Start Date:  Mon Feb  9 18:46:00 2009
Expiration Date:  Mon Feb  9 19:46:00 2009
```

4. To save changes, click **Apply**.

Configuring a Guest Provisioning User

The guest provisioning user has access to the Guest Provisioning Page (GPP) to create guest accounts within your company. The guest provisioning user is usually a person at the front desk who greets guests and creates guest accounts. Depending upon your needs, there are three ways to configure and authenticate a guest provisioning user:

- Username and Password authentication — Allows you to configure a user in a guest provisioning role.
- Smart Card authentication
 - Static authentication — Uses a configured certificate name and serial number to derive the user role. This authentication process uses a previously configured certificate name and serial number to derive the user role. This method does not use an external authentication server.
 - Authentication server — Uses an external authentication server to derive the management role. This is helpful if there is a large number of users who need to be deployed as guest provisioning users.

You can use the WebUI or CLI to create a Guest Provisioning user.

In the WebUI

This section describes how to configure a guest provisioning user. All three methods are described.

Username and Password Authentication Method

1. Navigate to the **Configuration > Management > Administration** page.
2. In the Management Users section, click **Add**.
3. In the Add User page select **Conventional User Accounts**.
4. In the **User Name** field, enter the name of the user who you want to configure as a guest provisioning user.
5. In the **Password** and **Confirm Password** fields, enter the user's password and reconfirm it.
6. From the **Role** drop-down menu, select **guest-provisioning**.
7. Click **Apply**.

Static Authentication Method



NOTE: Before using this method, make sure that the correct CA certificate is uploaded to the controller.

1. Navigate to the **Configuration > Management > Administration** page.
2. In the Management Users section, click **Add**.

3. In the **Add User** page, select **Certificate Management**.
4. Make sure that the **Use external authentication server to authenticate** check box is unchecked.
5. In the **Username** field, enter the name of the user who you want to configure as a guest provisioning user.
6. In the **Role** field, select **guest-provisioning** from the drop-down list.
7. Enter client certificate serial number in the **Client Certificate Serial No.** field.
8. Select the CA certificate you want to use from the **Trusted CA Certificate Name** drop-down menu.
9. Click **Apply**.

Smart Card Authentication Method

1. Navigate to the **Configuration > Management > General** page.
2. In the **WebUI Management Authentication Method** section, select **Client Certificate**.
3. Click **Apply**.
4. Navigate to the **Configuration > Management > Administration** page.
5. In the **Management Authentication Servers** section, select **guest-provisioning** from the **Default Role** drop-down menu.
6. Select the **Mode** checkbox.
7. Select the server group from the **Server Group** drop-down menu.
8. Click **Apply**.
9. In the **Management Users** section, click **Add** to display the **Configuration > Management > Add User** page.
10. Select **Certificate Management**, **WebUI Certificate** and **Use external authentication server to authenticate**.
11. Select the trusted CA certificate you want to use from the **Trusted CA Certificate Name** drop-down menu.
12. Click **Apply** and **Save Configuration**.

In the CLI

Username and Password Method

This example creates a user named Paula and assigns her the role of guest provisioning.

```
(host) (config)# mgmt-user Paula guest-provisioning
```

Static Authentication Method

This example uses the CA certificate **mycertificate** with the serial number 1234 to authenticate user Laura in the guest provisioning role.

```
(host) (config)# mgmt-user webui-cacert mycertificate serial 1234 Laura guest-provisioning
```

Smart Card Authentication Method

This example shows that using previously configured certificate (1234), authentication and authorization are automatically configured using an authentication server.

```
(host) (config) #web-server mgmt-auth username/password certificate
(host) (config) #mgmt-user webui-cacert <certificate_name>
(host) (config) #aaa authentication mgmt
(host) (config) # server-group "internal"
(host) (config) #mgmt-user webui-cacert default
(host) (config) #mgmt-user webui-cacert 1234
```

Customizing the Guest Access Pass

In the WebUI, you can customize the pop-up window that displays the guest account information. You may want to do this before the Guest Provisioning user creates guest accounts.

1. Navigate to the **Configuration > Security > Access Control > Guest Access** page.
2. Click **Browse** to insert a logo or other banner information on the window.



NOTE: Best practices is to use a logo or banner image that is 600 x 100 pixels (width x height). The WebUI does not apply the size restrictions when you upload an image file, but the image is resized to 600 x 100 pixels when it displays or is printed.

3. You can enter text for the Terms and Conditions portion of the window.
4. Click **Submit** to save your changes. Click **Preview Pass** to preview the window. (See [Figure 264](#).)

Figure 264: Customized Guest Account Information Window



Creating Guest Accounts

After the Guest Provisioning user is created, that person can log in to the controller using the preconfigured username and password. The Guest Provisioning page displays. (See [Figure 266](#).) This is a sample page as the fields may differ based on how the network administrator designed the page.



NOTE: Starting with ArubaOS 3.4 release, a guest user account that is created by a guest provisioning user can only be viewed, modified or deleted by the guest provisioning user who created the account or the network administrator. A guest user account that is created by the network administrator can only be viewed, modified or deleted by the network administrator.

Figure 265: Creating a Guest Account—Guest Provisioning Page

Guests				
<input type="checkbox"/> Show details				
New Import Delete Print Edit				
Guest	Account			
Username	Full name	Company	Start	End
00:0b:86:66:2a:f9				
Laura	Laura R.	MyCompany	Aug 19, 2010 10:57 AM	Aug 19, 2010 06:57 PM
guest-8187776	Holden C.	Catcher Inc.	Aug 19, 2010 10:58 AM	Aug 19, 2010 06:58 PM



NOTE: If you do not want multiple guest users to share the same guest account concurrently, navigate to the Captive Portal Authentication and select the “Allow only one active user session” option. If a guest user authenticates successfully but the controller detects there is already a guest session with the same guest username, the second login is rejected.

Guest Provisioning User Tasks

The Guest Provisioning user creates guest accounts by filling in information on the Guest Provisioning page. Tasks include creating, editing, manually sending email, enabling, printing, disabling and deleting guest accounts. The Guest Provisioning user can also manually send emails to either the guest or sponsor.

To create a new guest account, the Guest Provisioning user clicks **New** to display the New Guest window. (See [Figure 266](#).) After filling in information into the fields, click **Create**. The guest account now displays on the Guest Provisioning page.

If you manually configure the user name and password, note the following:

- User name entries support alphanumeric characters, however the percent sign (%) and trailing the back slash are not allowed.
- Passwords must have a minimum of six characters. You can use special characters for the password.
- Click on the **Account Start** and **End** fields to change the account start and end times. The default account start to end time setting is eight hours.

Figure 266: *Creating a Guest Account—New Guest Window*

Guest	Account	
Username	Company	Start
Laura	ABC Company	Mar 19, 2009 12:32 P
guest9015890		Mar 19, 2009 12:36 P

To see details about an existing user account, highlight an existing account and select the **Show Details** checkbox. The Show Details popup-window displays. (See [Figure 267](#).) The Guest Provisioning user can send out Email from this window to either the guest or the sponsor. When you send an email from the Details pop-up window, a pop-up message confirming that the email was successfully processed displays.

Figure 267: Creating a Guest Account—Show Details Pop-up Window

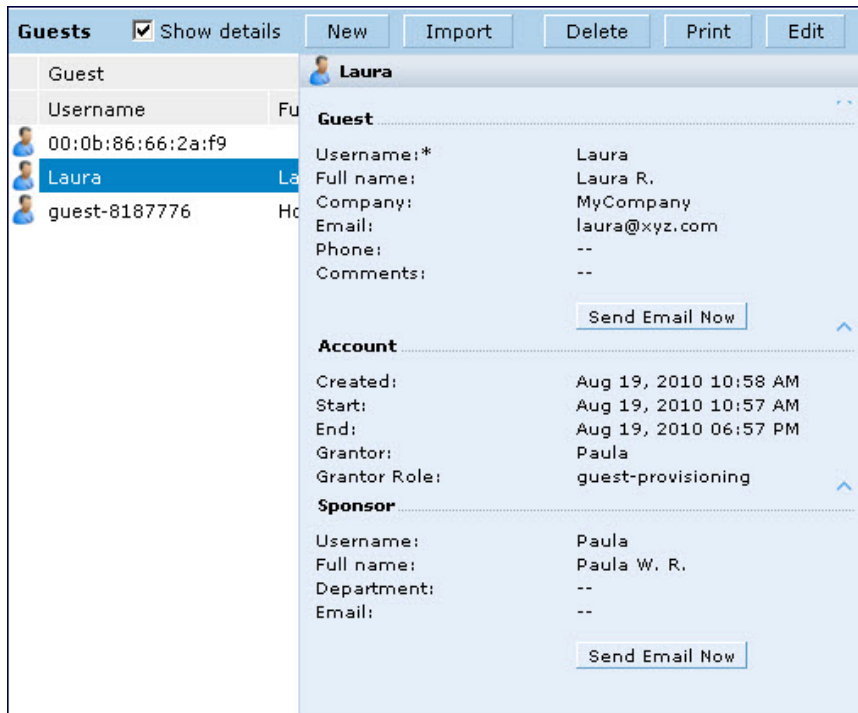

Importing Multiple Guest Entries

The Guest Provisioning user can manually create individual guest entries, as previously described, or import multiple guest entries into the database from a CSV file. This is useful and more efficient if you want to enter multiple guest entries at once. To import multiple guest entries, you need to:

1. Create a CSV file that contains the guest entries
2. Import the CSV file into the database

Creating Multiple Guest Entries in a CSV File

Create a CSV file that contains multiple guest entries. Each field in an entry needs to be separated by a comma and each entry needs to end with a carriage return. The order of the fields is:

- Guest's first name (required)
- Guest's last name (required)
- Guest's email address (optional)
- Guest's phone number (optional)
- Guest's user ID (optional)
- Guest's password (optional)
- Sponsor's first name (optional)
- Sponsor's last name (optional)
- Sponsor's email address (optional)

See [Figure 268](#) for an example of how guest entries need to be formatted in a CSV file.

Figure 269: Importing a CSV file that contains Guest Entries

Import Guest List

You can import a .csv file with a list of up to 250 guests.

Required fields:	Optional fields:
Guest First Name	Guest Email
Guest Last Name	Guest Phone Number
	Guest Userid
	Guest Password
	Sponsor First Name
	Sponsor Last Name
	Sponsor E-Mail

UsersIDs

If the file does not include the Guest UserID field, it will be auto-generated using the suffix. For example, guest0, guest1,...

Suffix for auto-generated field:

File to Import

File:

File has column headers [View sample file](#)

Account Duration

Start:

End:

3. Click **Browse** to locate for the CSV file you want to import.
4. Click **Import**. A window displays that lets you open CSV file in text format. (See [Figure 270](#).) Open the text file to see a summary of the number of users and error messages if users are not imported.

Figure 270: Displaying the Guest Entries Log File

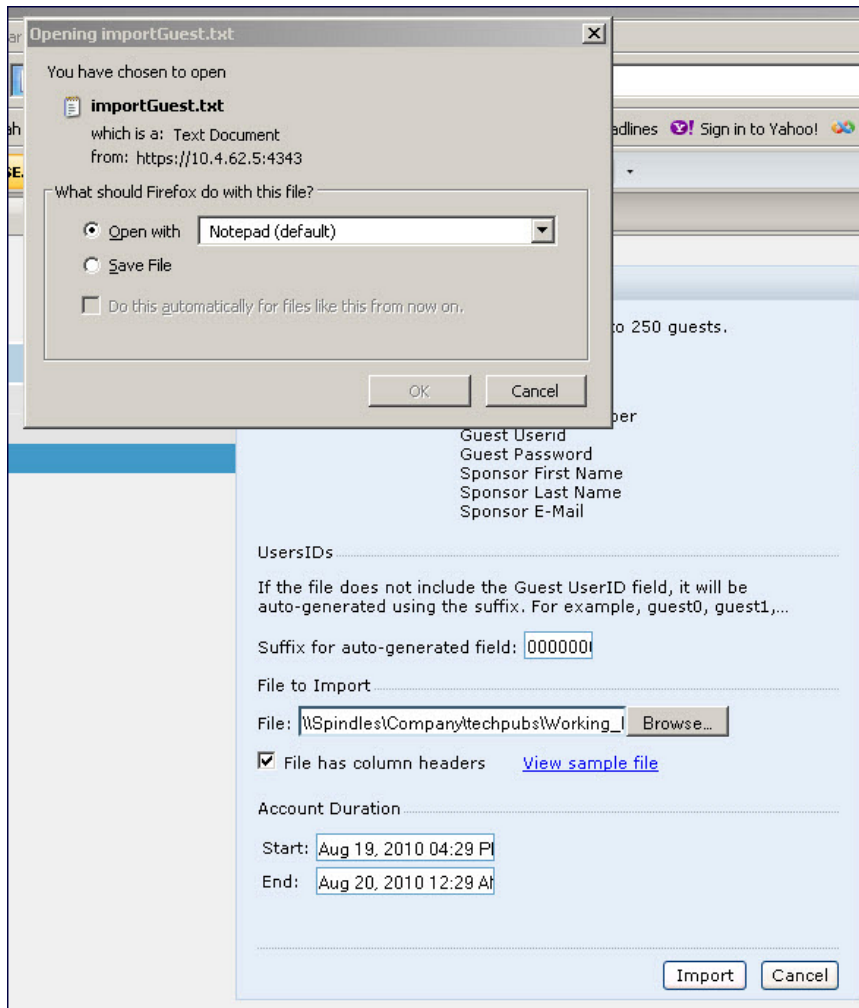

5. Click **Import**. A window displays that lets you open CSV file in text format. (See [Figure 270](#).)
6. Open the text file. (See [Figure 271](#).) Note that because no user ID is entered in the CSV file, a guest ID (username) is automatically generated based on the default value in the **Suffix for auto-generated field**. Make changes or corrections to the guest entry information in text file. A user can also change the start time and end time from this window. Save and exit the file.

Figure 271: Viewing and Editing Guest Entries in the Log File

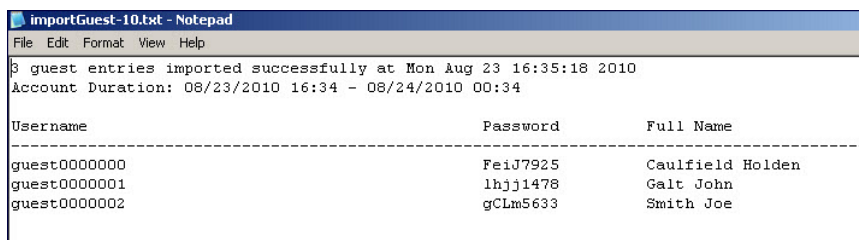

7. Click **Cancel** to close the **Import Guest List** window. Guest entries are now displayed in the Guest Provisioning page.

Figure 272: Viewing Multiple Imported Guest Entries—Guest Provisioning Page

GPP				
				Logout Username
Guests				
<input type="checkbox"/> Show details New Import Delete Print Edit				
Guest	Full name	Company	Account Start	Account End
00:0b:86:66:2a:f9				
guest0000002	Smith Joe		Aug 23, 2010 04:34 PM	Aug 24, 2010 12:34 AM
guest0000000	Caulfield Holden		Aug 23, 2010 04:34 PM	Aug 24, 2010 12:34 AM
guest0000001	Galt John		Aug 23, 2010 04:34 PM	Aug 24, 2010 12:34 AM

Printing Guest Account Information

To print guest account information:

1. Highlight the guest account you want to print and click **Print**. The **Print info for guest** window displays.
2. Click **Print password** if you want to print the guest password on the badge. Then enter or generate a new password for the guest. This modifies the existing guest password. (See [Figure 273](#).)
3. Optionally, click **Print policy text** if you want your company policy text to appear on the print out.
4. Click **Show preview** to view the information before it is printed.
5. Click **Print** to print the guest account information.

Figure 273: Printing Guest Account Information

Print info for guest Laura

Print password

Password:* Generate

Retype:*

Print policy text

[Hide preview](#)

My Company

Guest Account Information for

Username: Laura
 Password: vsougyy5035237
 Company:
 Start: Mar 19, 2009 02:19 PM
 End: Mar 19, 2009 03:19 PM

[Acceptable User Policy](#)

Print Cancel

Optional Configurations

This section describes guest provisioning options that the administrator can configure.



NOTE: These options are not configurable by the guest provisioning user.

Restricting one Captive Portal Session for each Guest

You can restrict one captive portal session for each guest. When a new captive portal request is received and passes authentication, all users are checked and compared with user names. If a user with the same name already exists and this option is enabled, the second login is denied.



NOTE: If a guest logs in from one system (and does not log out) and tries to log in again from another system, that guest has to wait for the initial session to expire.

1. Navigate to the **Configuration > Advanced Services > All s** page.
2. Select **Wireless Lan**.
3. Under Wireless Lan, select and open **Captive Portal Authentication**.
4. Add a new or select an existing
5. Select the **Allow only one active user session** check box.
6. Click **Apply**.

Using the CLI to restrict one Captive Portal session for each guest

```
(host)(config)# aaa authentication captive-portal <> single-session
```

Setting the Maximum Time for Guest Accounts

You can set the maximum expiration time (in minutes) for guest accounts. If the guest-provisioning user attempts to add a guest account that expires beyond this time period, an error message is displayed and the guest account is created with the maximum time you configured.



NOTE: If you set the maximum expiration time, it applies to all users in the internal database whether they are guests or not.

Using the WebUI to set the maximum time for guest accounts

1. Navigate to the **Configuration > Security > Authentication** page.
2. Select **Internal DB**.
3. Under Internal DB Maintenance, enter a value in Maximum Expiration.
4. Click **Apply**.

Using the CLI to set the maximum time for guest accounts

```
(host)# local-userdb maximum-expiration <minutes>
```

Managing Files on the Controller

You can transfer the following types of files between the controller and an external server or host:

- ArubaOS image file
- A specified file in the controller's flash file system, or a compressed archive file that contains the entire content of the flash file system



NOTE: You back up the entire content of the flash file system to a compressed archive file, which you can then copy from the flash system to another destination.

- Configuration file, either the active running configuration or a startup configuration
- Log files

You can use the following protocols to copy files to or from a controller:

- File Transfer Protocol (FTP): Standard TCP/IP protocol for exchanging files between computers.
- Trivial File Transfer Protocol (TFTP): Software protocol that does not require user authentication and is simpler to implement and use than FTP.

- Secure Copy (SCP): Protocol for secure transfer of files between computers that relies on the underlying Secure Shell (SSH) protocol to provide authentication and security.



NOTE: You can use SCP only for transferring image files to or from the controller, or transferring files between the flash file system on the controller and a remote host. The SCP server or remote host must support SSH version 2 protocol.

Table 274 lists the parameters that you configure to copy files to or from a controller.

Table 274: File Transfer Configuration Parameters

Server Type	Configuration
Trivial File Transfer Protocol (TFTP)	<ul style="list-style-type: none"> • IP address of the server • filename
File Transfer Protocol (FTP)	<ul style="list-style-type: none"> • IP address of the server • username and password to log into server • filename
Secure Copy (SCP) You must use the CLI to transfer files with SCP.	<ul style="list-style-type: none"> • IP address of the server or remote host • username to log into server • absolute path of filename (otherwise, SCP searches for the file relative to the user's home directory)

For example, you can copy an ArubaOS image file from an SCP server to a system partition on a controller or copy the startup configuration on a controller to a file on a TFTP server. You can also store the contents of a controller's flash file system to an archive file which you can then copy to an FTP server. You can use SCP to securely download system image files from a remote host to the controller or securely transfer a configuration file from flash to a remote host.

Transferring ArubaOS Image Files

You can download an ArubaOS image file onto a controller from a TFTP, FTP, or SCP server. In addition, the WebUI allows you to upload an ArubaOS image file from the local PC on which you are running the browser.

When you transfer an ArubaOS image file to a controller, you must specify the system partition to which the file is copied. The WebUI shows the current content of the system partitions on the controller. You have the option of rebooting the controller with the transferred image file.

In the WebUI

1. Navigate to the **Maintenance > Controller > Image Management** page.
2. Select TFTP, FTP, SCP, or Upload Local File.
3. Enter or select the appropriate values for the file transfer method.
4. Select the system partition to which the image file is copied.
5. Specify whether the controller is to be rebooted after the image file is transferred, and whether the current configuration is saved before the controller is rebooted.
6. Click **Upgrade**.

In the CLI

```
copy tftp: <tftphost> <filename> system: partition [0|1]
copy ftp: <ftphost> <user> <filename> system: partition {0|1}
copy scp: <scphost> <username> <filename> system: partition [0|1]
```

Backing Up and Restoring the Flash File System

You can store the entire content of the flash file system on a controller to a compressed archive file. You can then copy the archive file to an external server for backup purposes. If necessary, you can restore the backup file from the server to the flash file system.

Backup the Flash File System in the WebUI

1. Navigate to the **Maintenance > File > Backup Flash** page.
2. Click **Create Backup** to back up the contents of the flash system to the flashbackup.tar.gz file.
3. Click **Copy Backup** to enter the Copy Files page where you can select the destination server for the file.
4. Click **Apply**.

Backup the Flash File System in the CLI

```
backup flash
copy flash: flashbackup.tar.gz tftp: <tftphost> <destfilename>
copy flash: flashbackup.tar.gz scp: <scphost> <username> <destfilename>
```

Restore the Flash File System in the WebUI

1. Navigate to the **Maintenance > File > Copy Files** page.
 - a. For Source Selection, specify the server to which the flashbackup.tar.gz file was previously copied.
 - b. For Destination Selection, select Flash File System.
 - c. Click **Apply**.
2. Navigate to the **Maintenance > File > Restore Flash** page.
3. Click **Restore** to restore the flashbackup.tar.gz file to the flash file system.
4. Navigate to the **Maintenance > Switch > Reboot Switch** page.
5. Click **Continue** to reboot the controller.

Restore the Flash File System in the CLI

```
copy tftp: <tftphost> <srcfilename> flash: flashbackup.tar.gz
copy scp: <scphost> <username> <srcfilename> flash: flashbackup.tar.gz
restore flash
```

Copying Log Files

You can store log files into a compressed archive file which you can then copy to an external TFTP or SCP server. The WebUI allows you to copy the log files to a WinZip folder which you can display or save on your local PC.

In the WebUI

1. Navigate to the **Maintenance > File > Copy Logs** page.
2. For Destination, specify the TFTP or FTP server to which log files are copied.
3. Select **Download Logs** to download the log files into a WinZip file on your local PC,
4. Click **Apply**.

In the CLI

```
tar logs
copy flash: logs.tar tftp: <tftphost> <destfilename>
copy flash: logs.tar scp: <scphost> <username> <destfilename>
```

Copying Other Files

The flash file system contains the following configuration files:

- **startup-config**: Contains the configuration options that are used the next time the controller is rebooted. It contains all options saved by clicking the **Save Configuration** button in the WebUI or by entering the **write memory** CLI command. You can copy this file to a different file in the flash file system or to a TFTP server.
- **running-config**: Contains the current configuration, including changes which have yet to be saved. You can copy this file to a different file in the flash file system, to the startup-config file, or to a TFTP or FTP server.

You can copy a file in the flash file system or a configuration file between the controller and an external server.

In the WebUI

1. Navigate to the **Maintenance > File > Copy Files** page.
2. Select the source where the file or image exists.
3. Select the destination to where the file or image is to be copied.
4. Click **Apply**.

In the CLI

```
copy startup-config flash: <filename>
copy startup-config tftp: <tftphost> <filename>

copy running-config flash: <filename>
copy running-config ftp: <ftphost> <user> <password> <filename> [<remote-dir>]
copy running-config startup-config
copy running-config tftp: <tftphost> <filename>
```

Setting the System Clock

You can set the clock on a controller manually or by configuring the controller to use a Network Time Protocol (NTP) server to synchronize its system clock with a central time source.

Manually Setting the Clock

You can use either the WebUI or CLI to manually set the time on the controller's clock.

In the WebUI

1. Navigate to the **Configuration > Management > Clock** page.
2. Under **Controller Date/Time**, set the date and time for the clock.
3. Under **Time Zone**, enter the name of the time zone and the offset from Greenwich Mean Time (GMT).
4. To adjust the clock for daylight savings time, click **Enabled** under Summer Time. Additional fields appear that allow you to set the offset from UTC, and the start and end recurrences.
5. Click **Apply**.

In the CLI

To set the date and time, enter the following command in privileged mode:

```
clock set <year> <month> <date> <hour> <minutes> <seconds>
```

To set the time zone and daylight savings time adjustment, enter the following commands in configure mode:

```
clock timezone <WORD> <-23 - 23>

clock summer-time <zone> [recurring]
```

```
<1-4> <start day> <start month> <hh:mm>
first <start day> <start month> <hh:mm>
last <start day> <start month> <hh:mm>
<1-4> <end day> <end month> <hh:mm>
first <end day> <end month> <hh:mm>
last <end day> <end month> <hh:mm>
[<-23 - 23>]
```

Clock Synchronization

You can use NTP to synchronize the controller to a central time source. Configure the controller to set its system clock using NTP by configuring one or more NTP servers.

For each NTP server, you can optionally specify the NTP iburst mode for faster clock synchronization. The iburst mode sends up ten queries within the first minute to the NTP server. (When iburst mode is not enabled, only one query is sent within the first minute to the NTP server.) After the first minute, the iburst mode typically synchronizes the clock so that queries need to be sent at intervals of 64 seconds or more.



NOTE: The iburst mode is a configurable option and not the default behavior for the controller, as this option is considered “aggressive” by some public NTP servers. If an NTP server is unresponsive, the iburst mode continues to send frequent queries until the server responds and time synchronization starts.

In the WebUI

1. Navigate to the **Configuration > Management > Clock** page.
2. Under NTP Servers, click **Add**.
3. Enter the IP address of the NTP server.
4. Select (check) the iburst mode, if desired.
5. Click **Add**.

In the CLI

```
ntp server ipaddr [iburst]
```

Configuring NTP Authentication

The Network Time Protocol adds security to an NTP client by authenticating the server before synchronizing the local clock. NTP authentication works by using a symmetric key which is configured by the user. The secret key is shared by both the controller and an external NTP server. This helps identify secure servers from fraudulent servers.

In the WebUI

1. Navigate to the **Configuration > Management > Clock** page.
2. Under NTP Authentication, make sure **Enable** is selected. Enable is the default.
3. Under NTP Servers, enter the NTP server IP address in the **NTP Server Address** field.
4. Under **NTP Identification Keys**, enter an identification key (a number between 1 and 65535) in the **Identification Key** field. Then add a secret string in the **Md5 Secret** field. The Md5 ID key must be an ASCII string up to 31 characters.
5. Click **Add**.
6. The identification key along with its corresponding Md5 secret string display in the **NTP Identification Keys** section.
7. Under NTP Trusted Keys, enter a string in the **Trusted Key** field. This is a subset of key which are trusted. The trusted key value must be numeric characters between 1 to 65535.

8. Click **Apply**.

In the CLI

This example enables NTP authentication, add authentication secret keys into the database, and specifies a subset of keys which are trusted. It also enables the `iburst` option.

```
(host) (config) #ntp authenticate
(host) (config) #ntp authentication-key <key-id> md5 <key-secret>
(host) (config) #ntp trusted-key <key-id>
(host) (config) #ntp <server IP> iburst key <key-id>
```

Timestamps in CLI Output

The timestamp feature can include a timestamp in the output of each `show` command issued in the command-line interface, indicating the date and time the command was issued. Note that the output of `show clock` and `show log` do not include timestamps, even when this feature is enabled.

To enable this feature, access the command-line interface in config mode and issue the command `clock append`.

```
(host) (config) #clock append
```

Enabling Capacity Alerts

Use the capacity alert feature to set controller capacity thresholds which, when exceeded, will trigger alerts. The controller will send a `wlsxThresholdExceeded` SNMP trap and a syslog error message when the controller has exceeded a set percentage of the total capacity for that resource. A `wlsxThresholdCleared` SNMP trap and error message will be triggered if the resource usage drops below the threshold once again.

The following table describes the thresholds that can be configured with this feature.

Table 275: Capacity Alert Thresholds

Threshold	Description
controlpath-cpu	Set an alert threshold for controlpath CPU capacity. The <percentage> parameter is the percentage of the total controlpath CPU capacity that must be exceeded before the alert is sent. The default threshold for this parameter is 80%.
controlpath-memory	Set an alert threshold for controlpath memory consumption. The <percentage> parameter is the percentage of the total memory capacity that must be exceeded before the alert is sent. The default threshold for this parameter is 80%.
datapath-cpu	Set an alert threshold for datapath CPU capacity. The <percentage> parameter is the percentage of the total datapath CPU capacity that must be exceeded before the alert is sent. The default threshold for this parameter is 30%.
no-of-APs	The maximum number of APs that can be connected to a controller is determined by that controller's model type and installed licenses. Use this command to trigger an alert when the number of APs currently connected to the controller exceeds a specific percentage of its total AP capacity. The default threshold for this parameter is 80%.
no-of-locals	Set an alert threshold for the master controller's capacity to support remote nodes and local Dell controllers. A master controller can support a combined total of 256 remote nodes and local Dell controllers. The <percentage> parameter is the percentage of the total master controller capacity that must be exceeded before the alert is sent. The default threshold for this parameter is 80%.
total-tunnel-capacity	Set an alert threshold for the controller's tunnel capacity. The <percentage> parameter is the

Threshold	Description
	percentage of the controller's total tunnel capacity that must be exceeded before the alert is sent. The default threshold for this parameter is 80%
user-capacity	Set an alert threshold for the controller's user capacity. The <percentage> parameter is the percentage of the total resource capacity that must be exceeded before the alert is sent. The default threshold for this parameter is 80%.

In the WebUI

1. Navigate to the **Configuration > Management > Threshold** page.
2. Modify the capacity percentages for any of the thresholds described in “Capacity Alert Thresholds” on page 657.
3. Click **Apply** to save your settings.

In the CLI

4. To configure this feature, access the command-line interface in config mode and issue the following commands:

```

threshold
  controlpath-cpu <percentage>
  controlpath-memory <percentage>
  datapath-cpu <percentage>
  no-of-APs <percentage>
  no-of-locals <percentage>
  total-tunnel-capacity <percentage>
  user-capacity <percentage>

```

Examples

The following command configures a new alert threshold for controlpath memory consumption:

```
(host) (config) #threshold datapath-cpu 90
```

If this threshold is exceeded then subsequently drops below the 90% threshold, the controller would send the following two syslog error messages.

```

May 14 13:13:58 nanny[1393]: <399816> <ERRS> |nanny| Resource 'Control-Path Memory' has
gone above 90% threshold, value : 93
May 14 13:16:58 nanny[1393]: <399816> <ERRS> |nanny| Resource 'Control-Path Memory' has
come below 90% threshold, value : 87

```

This chapter explains how to expand your network by adding a local controller to a master controller configuration. Typically, this is the first expansion of a network with just one controller (which is a master controller). This chapter is a basic discussion of creating master-local controller configurations. More complicated multi-controller configurations are discussed in other chapters.

This chapter describes the following topics:

- ["Moving to a Multi-Controller Environment" on page 666](#)
- ["Configuring Local Controllers" on page 664](#)

Configuring Local Controllers

This section highlights the difference in configuration for both of these scenarios.

The steps involved in migrating from a single to a multi-controller environment are:

1. Configure the role of the local controller to local and specify the IP address of the master.
2. Configure the layer-2 / layer-3 settings on the local controller (VLANs, IP subnets, IP routes).
3. Configure as trusted ports the ports the master and local controller use to communicate with each other.
4. For those APs that need to boot off the local controller, configure the LMS IP address to point to the new local controller.
5. Reboot the APs that are already on the network, so that they now connect to the local controller.

These steps are explained below.

You configure the role of a controller by running the initial setup on an unconfigured controller, or by using the WebUI, Controller Wizard, or CLI on a previously-configured controller.

Using the Initial Setup

Initial setup can be done using the browser-based Setup Wizard or by accessing the initial setup dialog via a serial port connection. Both methods are described in the *Dell PowerConnect W-Series ArubaOS Quick Start Guide* and are referred to throughout this chapter as "initial setup."

The initial setup allows you to configure the IP address of the controller and its role, in addition to other operating parameters. You perform the initial setup the first time you connect to and log into the controller or whenever the controller is reset to its factory default configuration (after executing a **write erase, reload** sequence).

When prompted to enter the controller role in the initial setup, select or enter **local** to set the controller operational mode to be a local controller. You are then prompted for the master controller IP address. Enter the IP address of the master controller for the WLAN network. Enter the preshared key (PSK) that is used to authenticate communications between Dell controllers.



NOTE: You need to enter the same PSK on the master controller and on the local Dell controllers that are managed by the master.

Using the Web UI

For a controller that is up and operating with layer-3 connectivity, configure the following to set the controller as local:

1. Navigate to the **Configuration > Network > Controller > System Settings** page.
2. Set the Controller Role to Local.
3. Enter the IP address of the master controller. If master redundancy is enabled on the master, this address should be the VRRP address for the VLAN instance corresponding to the IP address of the controller.
4. Enter the preshared key (PSK) that is used to authenticate communications between Dell controllers.



NOTE: You need to enter the same PSK on the master controller and on the local Dell controllers that are managed by the master.

Using the CLI

For a controller that is up and operating with layer-3 connectivity, configure the following to set the controller as local:

```
masterip <ipaddr> ipsec <key>
```

Configuring Layer-2/Layer-3 Settings

Configure the VLANs, subnets, and IP address on the local controller for IP connectivity.

Verify connectivity to the master controller by pinging the master controller from the local controller.

Ensure that the master controller recognizes the new controller as its local controller. The local controller should be listed with type **local** in the **Monitoring > Network > All WLAN Controllers** page on the master. It takes about 4 – 5 minutes for the master and local Dell controllers to synchronize configurations.

Configuring Trusted Ports

On the local controller, navigate to the **Configuration > Network > Ports** page and make sure that the port on the local controller connecting to the master is trusted. On the master controller, check this for the port on the master controller that connects to the local controller.

Configuring Local Controller Settings

Many controller settings are unique to that device and therefore are not replicated from a master controller to a local controller. The following settings must be manually configured on a local controller that synchronizes with the master controller.

- Time zone and daylight savings time settings
- VPN pools for remote APs and other VPN clients.
- Controller and IP interfaces. (Note that these values may need to be set *before* synchronization with the master so the synchronization can properly complete.)
- IP routing and spanning-tree configurations
- Remote AP whitelist and local-user database values



NOTE: By default, the local Dell controllers forward the authentication requests for the RAP whitelist and the local user database to the master controller. Therefore, this data does not have to be manually replicated *unless* the default behavior has been altered. The user table is NOT synchronized, so if an AP fails over to a master from a local or vice versa, that AP will have to re-authenticate.

- DHCP pools and reservations
- NAT pools

- SNMP, NTP, and syslog settings
- Hostnames, DNS and SMTP servers
- ACLs applied to ports
- Certificates
- RADIUS client details and RADIUS source interfaces
- Stateful firewall settings
- Customized captive portal pages and images, and the captive portal redirect address.

Configuring APs

APs download their configurations from a master controller. However, an AP or AP group can tunnel client traffic to a local controller. To specify the controller to which an AP or AP group tunnels client traffic, you configure the LMS IP in the AP system profile on the master controller.

Configuration changes take effect only after you reboot the affected APs; this allows them to reassociate with the local controller. After rebooting, these APs appear to the new local controller as local APs.

Using the WebUI to configure the LMS IP

1. Navigate to the **Configuration > Wireless > AP Configuration** page.
 - If you select AP Group, click Edit for the AP group name for which you want to configure the LMS IP.
 - If you select AP Specific, select the name of the AP for which you want to configure the LMS IP.
2. Under the Profiles section, select AP to display the AP profiles.
3. Select the AP system profile you want to modify.
4. Enter the controller IP address in the LMS IP field.
5. Click **Apply**.

Using the CLI to configure the LMS IP

```
ap system-profile <profile>
  lms-ip <ipaddr>

ap-group <group>
  ap-system-profile <profile>

ap-name <name>
  ap-system-profile <profile>
```

Moving to a Multi-Controller Environment

For a single WLAN configuration, the master controller is the controller which controls the RF and security settings of the WLAN. Additional Dell controllers to the same WLAN serve as local switches to the master controller. The local controller operates independently of the master controller and depends on the master controller only for its security and RF settings. You configure the layer-2 and layer-3 settings on the local controller independent of the master controller. The local controller needs to have connectivity to the master controller at all times to ensure that any changes on the master are propagated to the local controller.

Some of the common reasons to move from a single to a multi-controller-environment include:

- Scaling to include a larger coverage area
- Setting up remote Access Points (APs)
- Network setup requires APs to be redistributed from a single controller to multiple Dell controllers

You can use a preshared key (PSK) or a certificate to create IPsec tunnels between a master and backup master Dell controllers and between master and local Dell controllers. These inter-controller IPsec tunnels carry management traffic such as mobility, configuration, and master-local information.



NOTE: An inter-controller IPsec tunnel can be used to route data between networks attached to the Dell controllers if you have installed PEFV licenses in the Dell controllers. To route traffic, configure a static route on each controller specifying the destination network and the name of the IPsec tunnel.

There is a default PSK to allow inter-controller communications, however, for security you need to configure a unique PSK for each controller pair. You can use either the WebUI or CLI to configure a 6-64 character PSK on master and local Dell controllers. To configure a unique PSK for each controller pair, you must configure the master controller with the IP address of the local and the PSK, and configure the local controller with the IP address of the master and the PSK.

You can configure a global PSK for all master-local communications, although this is not recommended for networks with more than two Dell controllers. On the master controller, use 0.0.0.0 for the IP address of the local. On the local controller, configure the IP address of the master and the PSK.

The local controller can be located behind a NAT device or over the Internet. On the local controller, when you specify the IP address of the master controller, use the public IP address for the master.

If your master and local Dell controllers use a pre-shared key for authentication, the IPsec tunnel will be created using IKEv1. If they use a factory-installed or custom certificate, they will use IKEv2 to create the IPsec tunnel. Controllers using IKEv2 and custom-installed certificates can optionally use Suite-B encryption for IPsec encryption. For details and requirements for Suite-B encryption, see ["Configuring an SSID for Suite-B Cryptography" on page 329](#).

Configuring a Preshared Key

Leaving the PSK set to the default value exposes the IPsec channel to serious risk, therefore you should always configure a unique PSK for each controller pair.

Sharing the same PSK between more than two Dell controllers increases the likelihood of compromise. If one controller is compromised, all Dell controllers are compromised. Therefore, best security practices include configuring a unique PSK for each controller pair



WARNING: Do not use the default global PSK on a master or stand-alone controller. If you have a multi-controller network then configure the local Dell controllers to match the new IPsec PSK key on the master controller.

Weak keys are susceptible to offline dictionary attacks, meaning that a hostile eavesdropper can capture a few packets during connection setup and derive the PSK, thus compromising the connection. Therefore the PSK selection process should be the same process as selecting a strong passphrase:

- the PSK should be at least ten characters in length
- the PSK should not be a dictionary word
- the PSK should combine characters from at least three of the following four groups:
 - lowercase characters
 - uppercase characters
 - numbers
 - punctuation or special characters, such as `~'@$%^&*()_+ =\|/.,[]{}`

The following sections describe how to configure a PSK using the WebUI or CLI.

Using the WebUI to configure a Local Controller PSK

1. Navigate to the **Configuration > Network > Controller > System Settings** page.
2. The procedure to configure a local PSK varies, depending upon whether it is configured using a local controller or a master controller.
 - On a local controller, enter the IPsec key in the **IPsec Key (IKE PSK)** and **Retype IPsec Key (IKE PSK)** fields.
 - On a master controller, click **New** under **Local Controller IPsec Keys**, then enter the local controller IP address and then enter and retype the IPsec key. Click **Add**.
3. Click **Apply**.

Using the WebUI to configure a Master Controller PSK

Use the procedure below to configure the IP address and preshared key for the master controller.

1. Navigate to the **Configuration > Network > Controller > System Settings** page.
2. In the **IPSEC Key (IKE PSK)** field, enter the IPsec key. Reenter this key in the **Retype IPSEC Key (IKE PSK)** field.
3. (Optional) In the **FQDN** field, enter a fully qualified domain name used in IKE.
4. (Optional) Click the **Source IP address** field and select the VLAN ID of Vlan interface to initiate IKE. The controller IP address will be used if the VLAN is not specified.
5. Click **Apply**.

Using the CLI to configure a PSK

Master Controller

On the master controller you can configure a specific IPsec PSK for a local controller and use the `localip 0.0.0.0 ipsec` command:



NOTE: You need to change the secret key to a non-default PSK key value even if you use a per-local controller PSK key configuration.

```
localip 0.0.0.0 ipsec <secret_key>
localip <ipaddr> ipsec <secret_key>
```

Local Controller

On the local controller the secret key (PSK) must match the master controller's PSK.

```
masterip <ipaddr> ipsec <secret_key> [fqdn <fqdn>] [uplink] [vlan <id>]
```

Configuring a Controller Certificate

The following sections describe how to use the command-line interface to select a factory-installed or custom certificate for secure inter-controller communication.

Using the CLI to configure a Local Controller Certificate

- Issue the following command on a master controller to configure the factory-installed certificate for secure communication between that master and a local controller.

```
local-factory-cert local-mac <lmac>
```

In this command, `<lmac>` is the MAC address of the local controller's factory-installed certificate.
- Issue the following command on a master controller to configure a custom certificate for secure communication between that master and a local controller.

```
local-custom-cert local-mac <lmac> ca-cert <ca> server-cert <cert>
```

```
suite-b <gcm-128 | gcm-256>
```

In this command, **<lmac>** is the MAC address of the local controller's custom certificate.

Using the CLI to configure the Master Controller Certificate

Issue the following command on a local controller to configure the preshared key or certificate for the master controller.

```
masterip <ipaddr>  
  ipsec <key> [interface uplink|{vlan <id>}] [fqdn <fqdn>]  
  ipsec-custom-cert master-mac1 <mac1> [master-mac2 <mac2>] ca-cert <ca> server-cert <cert>  
  [interface uplink|{vlan <id>}] [fqdn <fqdn>] [suite-b gcm-128|gcm-256]  
  ipsec-factory-cert master-mac1 <mac1> [master-mac2 <mac2>] [interface uplink|{vlan <id>}]  
  [fqdn <fqdn>]
```

Chapter 36

Advanced Security

Extreme Security (xSec) is a cryptographically secure, Layer-2 tunneling network protocol implemented over the 802.1x protocol. The xSec protocol can be used to secure Layer-2 traffic between the Dell controller and wired and wireless clients, or between Dell controllers.



NOTE: xSec is an optional ArubaOS software module. You must purchase and install the license for the xSec software module on the controller.

Topics in this chapter include:

- ["Securing Client Traffic" on page 670](#)
- ["Securing Controller-to-Controller Communication" on page 677](#)
- ["Configuring the Odyssey Client on Client Machines" on page 678](#)

xSec encrypts an original Layer-2 data frame inside a Layer-2 xSec frame, the contents of which are defined by the protocol. xSec relies on 256-bit Advanced Encryption Standard (AES) encryption.

Upon 802.1x client authentication, xSec creates a tunnel between the client and the controller. The xSec frame sent over the air or wire between the user and the controller contains user and controller information, as well as original IP and MAC addresses, in encrypted form. All user information is secured using xSec. This concept is also extended to secure management information and data between two Dell controllers on the same VLAN.

For xSec tunneling between a client and controller to work, a version of the Funk Odyssey client software that supports xSec needs to be installed on the client. It is possible to secure clients running Windows 2000 and XP operating systems using xSec and the Odyssey client software..



NOTE: xSec is an optional licensed feature for Dell controllers. xSec is automatically enabled on the controller when you install the license. For information about the currently supported release for Funk Odyssey, please contact Juniper Networks.

xSec provides the following advantages:

- Advanced security as Layer-2 frames are encrypted and tunneled.
- Ease of implementation of advanced encryption in a heterogeneous environment. xSec is designed to support multiple operating systems and a wide range of network interface cards (NICs). All encryption and decryption on the client machine is performed by the Odyssey client while the NICs are configured with NULL encryption. This ensures that even older operating systems that cannot be upgraded to support WPA or WPA2 authentication can be secured using xSec and the Odyssey client.
- Compatible with TLS, TTLS and PEAP.
- Advanced authentication extended to wired clients allowing network managers to secure wired ports.

Securing Client Traffic

You can secure wireless or wired client traffic with xSec. On the client, install the Odyssey Client software. The xSec client must complete 802.1x authentication. to connect to the network. The client indicates the use of the xSec

protocol during 802.1x exchanges with the controller. (Dell controllers support 802.1x for both wired and wireless clients.) Upon successful client authentication, an xSec tunnel is established between the controller and the client.

The authenticated client is placed into a configured VLAN, which determines the client's DHCP server, IP address, and Layer-2 connection. For wireless xSec clients, the VLAN is the user VLAN configured for the WLAN. For wired xSec clients and wireless xSec clients that connect to the controller through a non-Dell AP, the VLAN is a designated xSec VLAN. The VLAN can also be derived from configured RADIUS server-derivation rules or from Vendor-Specific Attributes (VSAs). Once an xSec tunnel is established, a DHCP server assigns the xSec client an IP address from the address pool on the VLAN to which the client is assigned. All traffic between the client and the controller is then encrypted.

The following sections describe how to configure xSec on the controller for wireless and wired clients.

Securing Wireless Clients

The following are the basic steps for configuring the controller for xSec wireless clients:

1. Configure the user VLAN to which the authenticated clients will be assigned. See [Network Configuration Parameters on page 108](#) for more information.
2. Configure the user role for the authenticated xSec clients. See [Roles and Policies on page 296](#) for information.
3. Configure the server group that will be used to authenticate clients using 802.1x. See [Authentication Servers on page 168](#) for more information.
4. Configure the AAA profile to specify the 802.1x default user role. Specify the 802.1x authentication server group.



NOTE: You can configure the 802.1x authentication profile if necessary. See [802.1X Authentication on page 192](#) for more information.

5. Configure the virtual AP profile for the WLAN. Specify the previously-configured user VLAN. Only xSec clients will be allowed to connect to the WLAN and non-xSec connections are dropped.
 - a. Specify the previously-configured AAA profile.
 - b. Configure the SSID profile with xSec as the authentication.
6. Install and set up the Odyssey Client on the wireless client.

[Figure 276](#) is an example network where a wireless xSec client is assigned to the user VLAN 20 and the user role “employee” upon successful 802.1x authentication. VLAN 1 includes the port on the controller that connects to the wired network on which the AP is installed. (APs can connect to the controller across either a Layer-2 or Layer-3 network.)

Figure 276: Wireless xSec Client Example



The following sections describe how to use the WebUI or CLI to configure the AAA profile and virtual AP profile for this example. Other chapters in this manual describe the configuration of the user role, VLAN, authentication servers and server group, and 802.1x authentication profile.

In the WebUI

1. Navigate to the **Configuration > Security > Authentication > AAA Profiles** page.
 - a. To create a new AAA profile, click **Add** in the AAA Profiles Summary.
 - b. Enter a name for the profile (for example, `xsec-wireless`), and click **Add**.
 - c. To configure the AAA profile, click on the newly-created profile name.

- d. For 802.1x Authentication Default Role, select a configured user role (for example, **employee**).
 - e. Click **Apply**.
 - f. In the AAA Profile list, select 802.1x Authentication Profile under the AAA profile you configured. Select the applicable 802.1x authentication profile (for example, **xsec-wireless-dot1x**). Click **Apply**.
 - g. In the AAA Profile list, select 802.1x Authentication Server Group under the AAA profile you configured. Select the applicable server group (for example, **xsec-svrs**). Click **Apply**.
2. Navigate to the **Configuration > Wireless > AP Configuration** page. Select either the AP Group or AP Specific tab. Click **Edit** for the applicable AP group name or AP name.
 3. Under Profiles, select Wireless LAN, then select Virtual AP.
 4. To create a new virtual AP profile, select NEW from the Add a profile drop-down menu. Enter the name for the virtual AP profile (for example, **xsec-wireless**), and click **Add**.
 - a. In the Profile Details entry for the new virtual AP profile, select the AAA profile you previously configured. A pop-up window displays the configured AAA profile parameters. Click **Apply** in the pop-up window.
 - b. From the SSID profile drop-down menu, select NEW. A pop-up window allows you to configure the SSID profile.
 - c. Enter the name for the SSID profile (for example, **xsec-wireless**).
 - d. Enter the Network Name for the SSID (for example, **xsec-ap**).
 - e. For Network Authentication, select **xSec**.
 - f. Click **Apply** in the pop-up window.
 - g. At the bottom of the Profile Details page, click **Apply**.
 5. Click on the new virtual AP name in the Profiles list or in Profile Details to display configuration parameters.
 - a. Make sure Virtual AP enable is selected.
 - b. For VLAN, enter the ID of the VLAN in which authenticated xSec clients are placed (for example, **20**).
 - c. Click **Apply**.

In the CLI

```

aaa profile xsec-wireless
  authentication-dot1x xsec-wireless-dot1x
  d>ot1x-default-role employee
  d>ot1x-server-group xsec-svrs
wlan ssid-profile xsec-wireless
  essid xsec-ap
  opmode xSec
wlan virtual-ap xsec-wireless
  vlan 20
  aaa-profile xsec-wireless
  ssid-profile xsec-wireless

```

Securing Wired Clients

The following are the basic steps for configuring the controller for xSec wired clients:

1. Configure the VLAN to which the authenticated clients will be assigned. See [Network Configuration Parameters on page 108](#) for information.
This VLAN must have an IP interface, and is a different VLAN from the port's "native" VLAN that provides connectivity to the network.
2. Configure the user role for the authenticated xSec clients. See [Roles and Policies on page 296](#) for information.
3. Configure the server group that will be used to authenticate clients using 802.1x. See [Authentication Servers on page 168](#) for more information.

4. Configure the controller port to which the wired client(s) are connected. Specify the VLAN to which the authenticated xSec clients are assigned.
For firewall rules to be enforced after client authentication, the port must be configured as untrusted.
5. Configure the AAA profile to specify the 802.1x default user role and the 802.1x authentication server group.
6. Configure the wired authentication profile to use the AAA profile.
7. Install and set up the Odyssey Client on the wireless client.

Figure 277 is an example network where a wired xSec client is assigned to the VLAN 20 and the user role “employee” upon successful 802.1x authentication. Traffic between the controller and the xSec client is encrypted.

Figure 277: Wired xSec Client Example



The VLAN to which you assign an xSec client must be a different VLAN from the VLAN that contains the controller port to which the wired xSec client or AP is connected.

The following sections describe how to use the WebUI or CLI to configure the controller port to which the wired client is connected, the AAA profile, and the wired authentication profile for this example. Other chapters in this manual describe the configuration of the user role, VLAN, authentication servers and server group, and 802.1x authentication profile.

In the WebUI

1. Navigate to the **Configuration > Networks > Ports** page to configure the port to which the wired client(s) are connected.
 - a. Click the port that you want to configure.
 - b. Make sure the Enable Port checkbox is selected.
 - c. For Enter VLAN(s), select the native VLAN on the port to ensure Layer-2 connectivity to the network. In Figure 277, this is VLAN 1.
 - d. For xSec VLAN, select the VLAN to which authenticated users are assigned from the drop-down menu. In Figure 277, this is VLAN 20.
 - e. Click **Apply**.
2. Navigate to the **Configuration > Security > Authentication > AAA Profiles** page to configure the AAA profile.
 - a. To create a new AAA profile, click **Add**.
 - b. Enter a name for the profile (for example, **xsec-wired**), and click **Add**.
 - c. To configure the AAA profile, click on the newly-created profile name.
 - d. For 802.1x Authentication Default Role, select a configured user role (for example, **employee**).
 - e. Click **Apply**.
 - f. In the AAA Profile list, select 802.1x Authentication Profile under the AAA profile you configured. Select the applicable 802.1x authentication profile (for example, **xsec-wired-dot1x**). Click **Apply**.
 - g. In the AAA Profile list, select 802.1x Authentication Server Group under the AAA profile you configured. Select the applicable server group (for example, **xsec-svrs**). Click **Apply**.
3. Navigate to the **Configuration > Advanced Services > Wired Access** page.
 - a. Under Wired Access AAA Profile, select the AAA profile you just configured.
 - b. Click **Apply**.

In the CLI

```
interface fastethernet|gigabitethernet slot/port
  switchport access vlan 1
  xsec vlan 20
aaa profile xsec-wired
  authentication-dot1x xsec-wired-dot1x
  d>ot1x-default-role employee
  d>ot1x-server-group xsec-svrs
aaa authentication wired
  profile xsec-wired
```

Securing Wireless Clients Through Non-Dell APs

If xSec clients are connecting through a non-Dell AP, you need to configure the controller port to which the AP is connected. The AP must be configured for no (opensystem) authentication.

The following are the basic steps for configuring the controller for xSec wireless clients connecting through a non-Dell AP:

1. Configure the VLAN to which the authenticated clients will be assigned. See [Network Configuration Parameters on page 108](#) for information.

This VLAN must have an IP interface, and is a different VLAN from the port's "native" VLAN that provides connectivity to the network.

2. Configure the user role for the authenticated xSec clients. See [Roles and Policies on page 296](#) for information.
3. Configure the server group that will be used to authenticate clients using 802.1x. See [Authentication Servers on page 168](#) for more information.
4. Configure the controller port that connects to the wired network on which the non-Dell AP is installed. Specify the VLAN to which the authenticated xSec clients are assigned.

The ingress and egress ports for xSec client traffic must be different physical ports on the controller.

5. Configure the AAA profile to specify the 802.1x default user role and the 802.1x authentication server group.
6. Configure the wired authentication profile to use the AAA profile.
7. Install and set up the Odyssey Client on the wireless client.

The following sections describe how to use the WebUI or CLI to configure the controller port and AAA and wired authentication profiles for wireless clients connecting with non-Dell APs. Other chapters in this manual describe the configuration of the user role, VLAN, authentication servers and server group, and 802.1x authentication profile.

In the WebUI

1. Navigate to the **Configuration > Networks > Ports** page to configure the port to which the wireless xSec client (s) are connected.
 - a. Click the port that you want to configure.
 - b. Make sure the Enable Port checkbox is selected.
 - c. For Enter VLAN(s), select the native VLAN (for example, VLAN 1) on the port to ensure Layer-2 connectivity to the network.
 - d. For xSec VLAN, select the VLAN to which authenticated users are assigned from the drop-down menu (for example, VLAN 20)
 - e. Click **Apply**.
2. Navigate to the **Configuration > Security > Authentication > AAA Profiles** page to configure the AAA profile.
 - a. To create a new AAA profile, click **Add**.
 - b. Enter a name for the profile (for example, xsec-3party), and click **Add**.

- c. To configure the AAA profile, click on the newly-created profile name.
 - d. For 802.1x Authentication Default Role, select a configured user role (for example, **employee**).
 - e. Click **Apply**.
 - f. In the AAA Profile list, select 802.1x Authentication Profile under the AAA profile you configured. Select the applicable 802.1x authentication profile (for example, **xsec-NonDell-dot1x**). Click **Apply**.
 - g. In the AAA Profile list, select 802.1x Authentication Server Group under the AAA profile you configured. Select the applicable server group (for example, **xsec-svrs**). Click **Apply**.
3. Navigate to the Configuration > Advanced Services > Wired Access page.
 - a. Under Wired Access AAA Profile, select the AAA profile you just configured.
 - b. Click **Apply**.

In the CLI

```
interface fastethernet|gigabitethernet slot/port
  switchport access vlan 1
  xsec vlan 20
aaa profile xsec-wired
  authentication-dot1x xsec-NonDell-dot1x
  d>ot1x-default-role employee
  d>ot1x-server-group xsec-svrs
aaa authentication wired
  profile xsec-wired
```

Securing Clients on an AP Wired Port

APs with multiple wired Ethernet ports include an wired port profile that can enable or disable the wired port, define an AAA profile for wired port devices, and associate the port with an Ethernet link profile that defines its speed and duplex values.

In the WebUI

The procedure to create a new Ethernet port configuration profile depends upon whether or not you want to immediately associate that profile to a specific port on an AP.

1. **To configure a new Ethernet port configuration profile without assigning it to a specific port:**
 - a. Navigate to the **Configuration > All Profiles** page.
 - b. Expand the **AP** menu and select **AP Wired Port profile**.
 - c. In the **Profile Details** window, enter a name for the new profile, then click **Add**.

-or-

To create a new Ethernet port configuration profile for a specific port on an AP or group of APs:

- a. Navigate to the **Configuration > Wireless > AP Configuration** page.
 - b. Select either the **AP Group** or **AP Specific** tab. Click the **Edit** button by name of the AP group or individual AP you want to configure.
 - c. In the Profiles list, expand the **APprofile** menu and select the **Ethernet Interface Port Configuration** profile for the Ethernet port number you want to configure.
 - d. In the **Profile Details** window, click the **Ethernet interface port configuration** drop-down list and select **New**.
2. **Configure the Ethernet Interface Port/ Wired AP Port Configuration** profile parameters described in [Table 278](#).

Table 278: Ethernet Interface Port/ Wired AP Port Configuration Parameters

Parameter	Description
Shut Down	Disable the wired AP port.
Remote AP Backup	<p>If enabled, the port of Remote-AP is up for the local connectivity and troubleshooting when the controller is not reachable and no firewall policies will be applied.</p> <p>If disabled, the port would be up for the bridge mode when controller is not reachable, and retains the previous bridge wired port configuration (if the configuration is applied and persistent). For split and tunnel modes, the ports would be shutdown when the controller is not reachable.</p>
Time to wait for authentication to succeed	Authentication timeout value, in seconds, for devices connecting the AP's wired port. The supported range is 1-65535 seconds, and the default value is 20 seconds.

3. Each Ethernet Interface Port/AP Wired Port Configuration profile is automatically associated to the wired AP profile **Default**. To assign a new wired AP profile to the AP wired port:
 - a. Click the wired AP profile directly under the Ethernet port profile you are editing.
 - b. In the **Profile Details** window, click the **Wired AP Profile** drop-down list and select a new Wired AP profile.
4. A new AP wired profile is automatically associated to the Ethernet Interface Link profile **Default**. To assign a new Ethernet Interface Link profile to the AP wired port:
 - a. Click the Ethernet Interface Link profile directly under the Ethernet port profile you are editing.
 - b. In the **Profile Details** window, click the **Ethernet Interface Link** drop-down list and select a new Ethernet Interface Link profile.
5. By default, there is no AAA profile associated with an AP wired port profile. To assign an AAA profile to the AP wired port:
 - a. Click the AAA profile directly under the Ethernet port profile you are editing.
 - b. In the **Profile Details** window, click the **AAA Profile** drop-down list and select an AAA profile.
6. Click **Apply** to save your settings.

In the CLI

To create a new Ethernet Port/Wired AP Port profile, access the command-line interface in Config mode and issue the following command.

```
ap wired-port-profile <profile>
  aaa-profile <profile>
  authentication-timeout <seconds>
  enet-link-profile <profile>
  rap-backup
  shutdown
  wired-ap-profile <profile>
```

To associate an existing Ethernet Port/Wired AP Port profile to a specific interface on an AP or group of APs, access the command-line interface in Config mode and issue the following command.

```
ap-group <group>
  enet0-port-profile <profile>
  enet1-port-profile <profile>
  enet2-port-profile <profile>
  enet3-port-profile <profile>
  enet4-port-profile <profile>
```

Securing Controller-to-Controller Communication

xSec can be used to secure data and control traffic passed between two Dell controllers. The only requirement is that both Dell controllers be members of the same VLAN. To establish a point-to-point tunnel between the two Dell controllers, you need to configure the following for the connecting ports on each controller:

- The MAC address of the xSec tunnel termination point. This would be the MAC address of the “other” controller.
- A 16-byte shared key used to authenticate the Dell controllers to each other. You must configure the same shared key on both Dell controllers.
- The VLAN IDs for the VLANs that will extend across both the Dell controllers via the xSec. [Figure 279](#) shows an example network where two Dell controllers are connected to the same VLAN, VLAN 1. On controller 1, you configure the MAC address of controller 2 for the xSec tunnel termination point. On controller 2, you configure the MAC address of controller 1 for the xSec tunnel termination point. On both Dell controllers, you configure the same 16-byte shared key and the IDs for the VLANs which are allowed to pass through the xSec tunnel.

Figure 279: Controller-to-Controller xSec Example

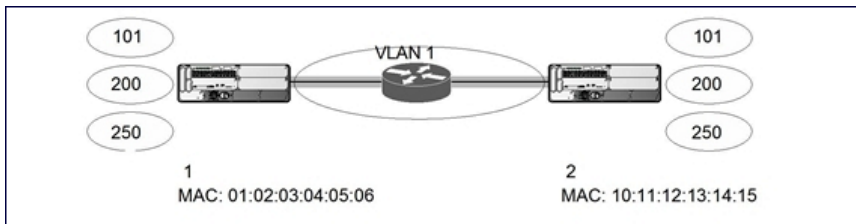

Configuring Controllers for xSec

The following sections describe how to use the WebUI or CLI to configure the port that connects to the wired network on which the other controller is installed. Other chapters in this manual describe the configuration of VLANs.

In the WebUI

1. On each controller, navigate to the **Configuration > Network > Port** page.
2. Click on the port to be configured.
3. Select the VLAN from the drop-down list.
4. Configure the xSec point-to-point settings:
 - a. Enter the MAC address of the tunnel termination point (the “other” controller’s MAC address).
 - b. Enter the key (for example, 1234567898765432) used by xSec to establish the tunnel between the Dell controllers.
 - c. Select the VLANs that would be allowed across the point-to-point connection from the Allowed VLANs drop-down menu, and click the <-- button.
5. Click **Apply**.

In the CLI

For Controller 1:

```
interface gigabitethernet|fastethernet slot/port
  vlan 1
  xsec point-to-point 10:11:12:13:14:15 1234567898765432 allowed vlan 101,200,250
```

For Controller 2:

```
interface gigabitethernet|fastethernet slot/port
```

```
vlan 1
xsec point-to-point 01:02:03:04:05:06 1234567898765432 allowed vlan 101,200,250
```

Configuring the Odyssey Client on Client Machines

You can obtain the Odyssey Client from Juniper Networks. For information on Odyssey Client versions, contact Dell Networks or Juniper Networks support.

Installing the Odyssey Client

1. Unzip and install the Odyssey client on the client laptop.
2. For wired xSec, to use the Odyssey client to control the wired port, modify the registry:
 - a. On the windows machine, click **Start** and select **Run**.
 - b. Type **regedit** in the dialog box and click **OK**.
 - c. Navigate down the tree to
HKEY_LOCAL_MACHINE\SOFTWARE\Funk Software,
Inc.\odyssey\client\configuration\options\wiredxsec.

Figure 280: The regedit Window

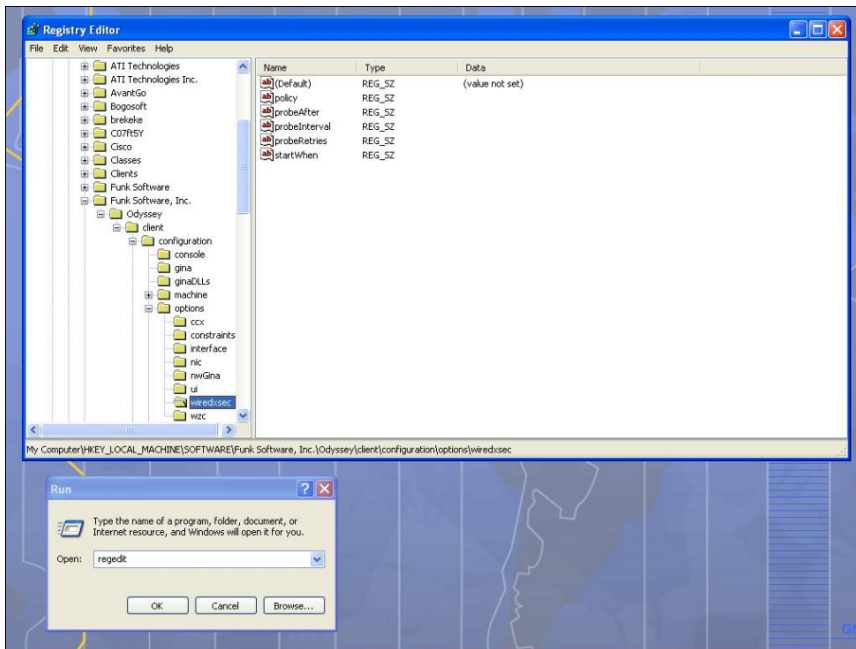

- d. Select “policy” from the registry values and right click on it. Select **Modify** to modify the contents of policy. Set the value in the resulting window to **required**.

Figure 281: Modifying a regedit Policy

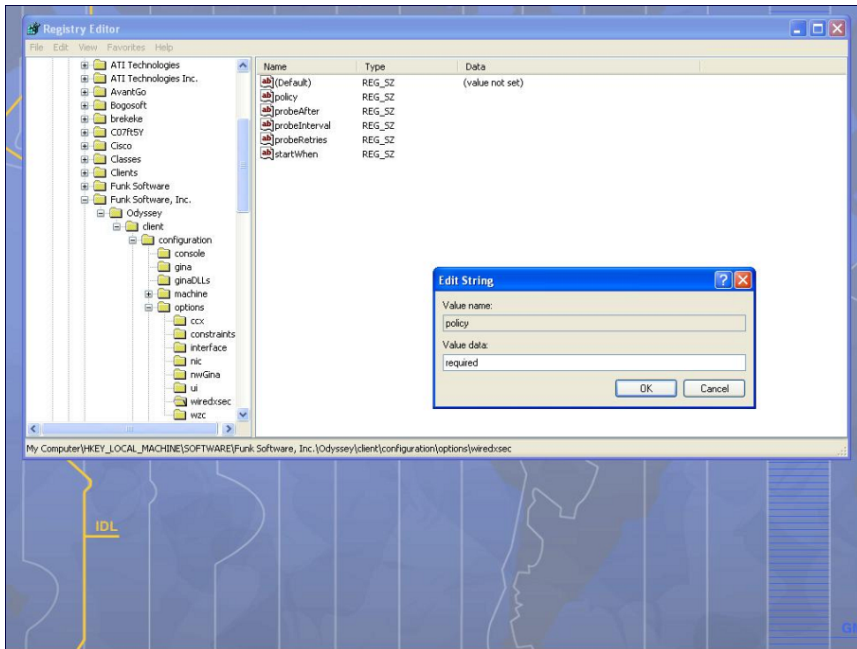

3. Open the Funk Odyssey Client. Click the **Profile** tab in the client window. This allows the user to create the user profile for 802.1x authentication.

Figure 282: The Funk Odyssey Client Profile

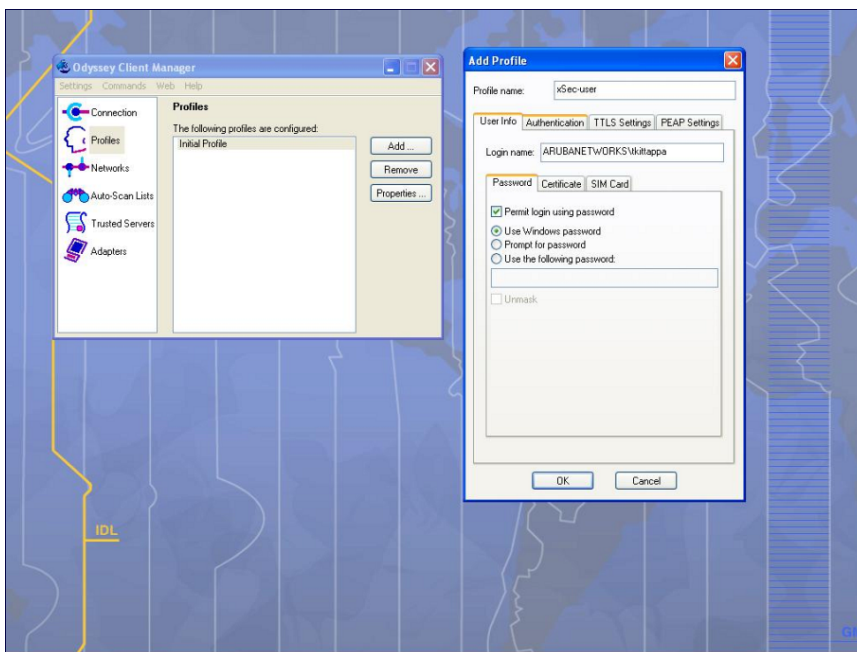

- a. In the login name dialog box, enter the login name used for 802.1x authentication. For the password, the client could use the WINDOWS password or use the configured password based on the selection made.
- b. Click the certificate tab and enter the certificate information required. This example shows the PEAP settings.

Figure 283: Certificate Information

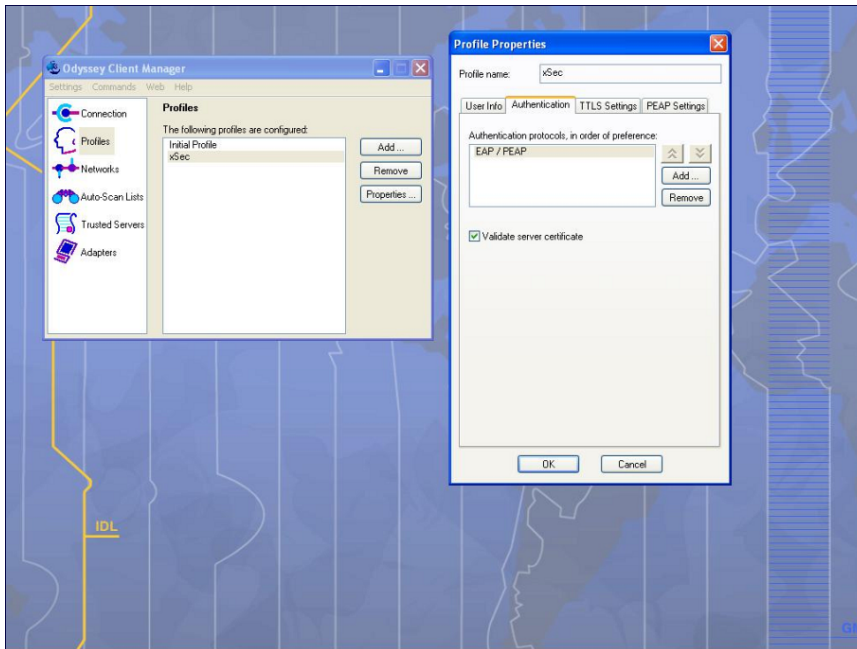

- c. Click the **Authentication** tab. In the resultant window, click the **Add** tab and select **EAP/PEAP**. Move this option to the top of the list if PEAP is the method chosen. If certification validation not required, uncheck the **Validate server certificates** setting.
 - d. Click the **PEAP Settings** tab and select the EAP protocol supported.
 - e. Click **OK**.
 - f. To modify an existing profile, select the profile and then click the **Properties** tab.
4. Select the **Network** tab to configure the network for wireless client. For wired clients, skip this step.

Figure 284: Network Profile

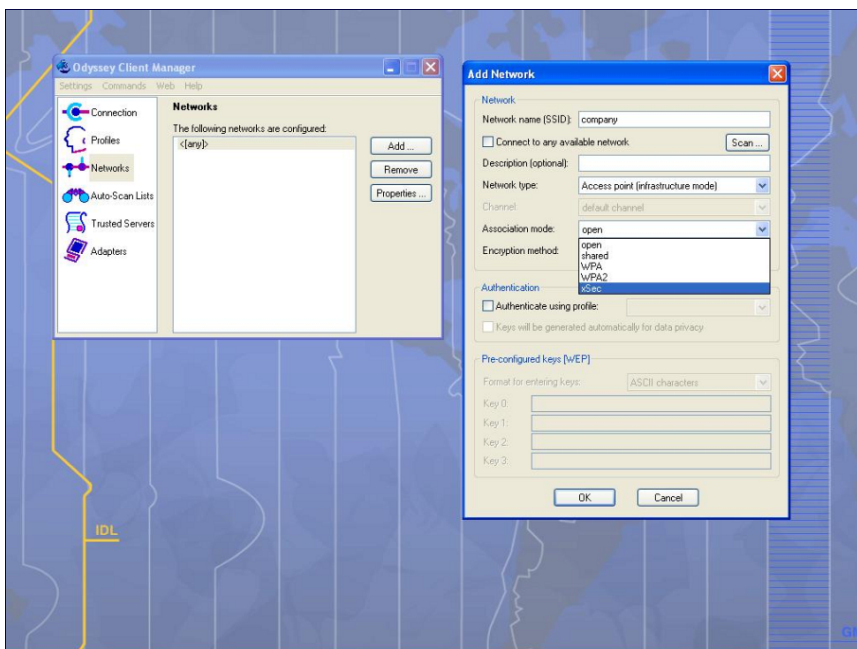

- a. Click the **Add** tab. Enter the SSID to which the client connects.

- b. Set the Network type to **Infrastructure**.
 - c. Set the Association mode to **xSec**, AES encryption is automatically selected.
 - d. Under Authentication, select the **Authenticate using profile** checkbox.
 - e. From the pull down menu, select the profile used for 802.1x authentication. This would be one of the profiles configured in step 2.
 - f. Select the keys that will be generated automatically for data privacy.
 - g. Apply the configuration changes made by clicking on the **OK** tab.
 - h. To modify an existing profile, select the profile and then click the **Properties** tab.
5. Click the **Adapters** tab if the adapter used is not seen under the list of adapters pull down menu under connections.
 - a. When using a wireless client, click the **Wireless** tab.
 - b. Select the **Wireless adapters only** radio button. From the resulting list, select the adapter required from the list and click **OK**.
 - c. For wired 802.1x clients, select the **Wired 802.1x** tab and select the **Wired adapters only** radio button. From the resulting list, select the adapter required from the list and click **OK**.
 6. Establish the connection.
 - a. Click the **Connection** tab.
 - b. From the pull down menu, select the adapter required. If the adapter in use is not visible, add the adapter as explained in Step 5.
 - c. Select the **Connect to network** checkbox and select the **Network** option from the pull down menu. To configure a new network, follow the instructions in Step 4.
 - d. This will automatically start the connection process. To reconnect to the network, click **Reconnect**.
 7. Click **Scan** to display the SSIDs seen by the NIC after a site survey.

Chapter 37

Voice and Video

This chapter outlines the steps required to configure voice and video services on the Dell controller for Voice over IP (VoIP) devices, including Session Initiation Protocol (SIP), Spectralink Voice Priority (SVP), H323, SCCP, Vocera, and Alcatel NOE phones, clients running Microsoft Office Communicator Server (OCS), and Apple devices running the Facetime application. Since video and voice applications are more vulnerable to delay and jitter, the network infrastructure must be able to prioritize video and voice traffic over data traffic.

This chapter includes the following topics:

- ["Voice and Video License Requirements" on page 682](#)
- ["Configuring Voice and Video" on page 682](#)
- ["Working with QoS for Voice and Video" on page 694](#)
- ["Understanding Extended Voice and Video Features" on page 703](#)
- ["Advanced Voice Troubleshooting" on page 720](#)

Voice and Video License Requirements

The voice and video services require PEFNG licenses on the controller. For complete details on the required licenses, see [Software Licenses on page 100](#).

Configuring Voice and Video

This section describes the steps required to set up and configure voice features on a Dell controller. To configure voice features you must do the following:

1. Set up net services
2. Configure roles
3. Configure firewall settings for voice and video ALGs
4. Configure other parameters depending on the need and environment



NOTE: Assigning voice traffic to the high priority queue is recommended when deploying voice over WLAN networks.

Setting up Net Services

You can either use the default net services and ports or you can create or modify net services.

Using Default Net Services

The following table lists the default net services and their ports:

Table 285: Default Voice Net Services and Ports

Net Service Name	Protocol	Port	ALG
svc-sccp	TCP	2000	SCCP
svc-sip-tcp	TCP	5060	SIP
svc-sip-udp			SIP
svc-sips			SIP
svc-noe	UDP	32512	NOE
svc-h323-udp	UDP	1718, 1719	H.323
svc-h323-tcp	TCP	1720	H.323
svc-vocera			VOCER-A
svc-svp		None	SVP

Creating Custom Net Services

You can use CLI to create or modify net services. In the config mode on the controller enter:

```
(host) (config)# netservice [service name] [protocol] [port] [alg]
```

To create an *svc-noe* service on UDP port 32522, enter:

```
(host) (config)# netservice svc-noe udp 32522 alg noe
```

Configuring User Roles

In the user-centric network, the user role of a wireless client determines its privileges and the type of traffic that it can send or receive in the wireless network. You can configure roles for clients that use mostly data traffic, such as laptops, and roles for clients that use mostly voice traffic, such as VoIP phones. Although there are different ways for a client to derive a user role, in most cases the clients using data traffic are assigned a role after they are authenticated through a method such as 802.1x, VPN, or captive portal. The user role for VoIP phones is derived from the OUI of their MAC addresses or the SSID to which they associate. Refer to [Roles and Policies on page 296](#) for details on how to create and configure a user role.

This section describes how to configure voice user roles with the required privileges and priorities. Dell controller provides default user roles for all voice services. You can do one of the following:

- Use default user roles
- Create or modify user roles
- Use user-derivation roles

Using the Default User Role

The controller is configured with the default voice role. This role has the following settings:

- No limit on upload or download bandwidth
- Default L2TP and PPTP pool
- Maximum sessions: 65535

The following ACLs are associated with the default voice role:

- SIP-ACL
- NOE-ACL
- SVP-ACL
- VOCERA-ACL
- SKINNY-ACL
- H323-ACL
- DHCP-ACL
- TFTP-ACL
- DNS-ACL
- ICMP-ACL

For more details on the default voice role, enter the following command in the config mode on your controller:

```
(host) (config) #show rights voice
```

Creating or Modifying Voice User Roles

You can create roles for NOE, SIP, SVP, Vocera, SCCP, and H.323 ALGs. Use the WebUI or CLI to configure user roles for any of the ALGs.

Using the WebUI to configure user roles

1. Navigate to the **Configuration > Security > Access Control** page.
2. Select the **Policies** tab. Click **Add** to create a new policy.
3. For Policy Name, enter a name here.
4. For Policy Type, select **Session**.
5. Under Rules, click **Add**.
 - a. For IP Version, select **IPv4**.
 - a. For Source, select **any**.
 - b. For Destination, select **any**.
 - c. For Service, select service, then select the correct voice or video ALG service. See [Table 286](#) and [Table 287](#) for service names for all ALGs.:

Table 286: Services for ALGs

ALG	Service Name
NOE	<ul style="list-style-type: none"> • svc-noe • sip-noe-oxo
SIP	<ul style="list-style-type: none"> • svc-sips • svc-sip-tcp • svc-sip-udp
SVP	<ul style="list-style-type: none"> • svc-svp
VOCERA	<ul style="list-style-type: none"> • svc-vocera
SCCP	<ul style="list-style-type: none"> • svc-sccp
H.323	<ul style="list-style-type: none"> • svc-h323-tcp

ALG	Service Name
	<ul style="list-style-type: none"> • svc-h323-udp
DHCP	svc-dhcp
TFTP	svc-tftp
ICMP	svc-icmp
DNS	svc-dns

Table 287: Other Mandatory Services for the ALGs

ACL	Service Name
DHCP	svc-dhcp
TFTP	svc-tftp
ICMP	svc-icmp
DNS	svc-dns

- d. For Action, select **permit**.
- e. For Queue, select **High**.
- f. Click **Add**. Repeat steps 1 to 5e to add more ALG services.
6. Click **Apply**.
7. Select the User Roles tab. Click **Add** to add a user role.
 - a. For Role Name, enter a name for the user role.
 - b. Under Firewall Policies, click **Add**.
 - c. Select the previously-configured policy name from the **Choose from Configured Policies** drop-down menu.
 - d. Click **Done**.
 - e. Under Firewall Policies, click **Add**.
 - f. Select *control* from the **Choose from Configured Policies** drop-down menu.
 - g. Click **Done**.
8. Click **Apply**.

Using the CLI to configure a user role

```
ip access-list session <policy-name>
  any any <service-name> permit queue high
  any any dhcp-acl permit queue high
  any any tftp-acl permit queue high
  any any dns-acl permit queue high
  any any icmp-acl permit queue high
```

```
user-role <role-name>
  session-acl <policy-name>
```

Replace the following strings:

- *policy-name* with a string that you want to identify the roles policy

- *role-name* with the name you want to identify the voice user role.
- *service-name* with any of the service names from [Table 285](#).

Using the User-Derivation Roles

The user role can be derived from attributes from the client's association with an AP. For VoIP phones, you can configure the devices to be placed in their user role based on the SSID or the Organizational Unit Identifier (OUI) of the client's MAC address.



NOTE: User-derivation rules are executed *before* the client is authenticated.

Using the WebUI to derive the role based on SSID

1. Navigate to the **Configuration > Security > Authentication > User Rules** page.
2. Click **Add** to add a new set of derivation rules. Enter a name for the set of rules, and click **Add**. The name appears in the User Rules Summary list.
3. In the User Rules Summary list, select the name of the rule set to configure rules.
4. Click **Add** to add a rule. For Set Type, select Role from the drop-down menu.
5. For **Rule Type**, select **ESSID**.
6. For **Condition**, select **equals**.
7. For **Value**, enter the SSID used for the phones.
8. For **Roles**, select the user role you previously created.
9. Click **Add**.
10. Click **Apply**.

Using the CLI to derive the role based on SSID

```
aaa derivation-rules user name
    set role condition essid equals ssid set-value role
```

Using the WebUI to derive the role based on MAC OUI

1. Navigate to the **Configuration > Security > Authentication > User Rules** page.
2. Click **Add** to add a new set of derivation rules. Enter a name for the set of rules, and click **Add**. The name appears in the User Rules Summary list.
3. In the User Rules Summary list, select the name of the rule set to configure rules.
4. Click **Add** to add a rule. For Set Type, select Role from the drop-down menu.
5. For **Rule Type**, select **MAC Address**.
6. For **Condition**, select **contains**.
7. For **Value**, enter the first three octets (the OUI) of the MAC address of the phones (for example, the Spectralink OUI is 00:09:7a).
8. For **Roles**, select the user role you previously created.
9. Click **Add**.
10. Click **Apply**.

Using the CLI to derive the role based on MAC OUI

```
aaa derivation-rules user name
    set role condition macaddr contains xx:xx:xx set-value role
```

Configuring Firewall Settings for Voice and Video ALGs

After configuring the user roles, you must configure the firewall settings for the voice and video Application-Level Gateways (ALGs) to pass the traffic securely through the Dell devices.

You can use the WebUI or CLI to configure the firewall settings for the ALGs.

In the WebUI

1. Navigate to the **Configuration > Advanced Services > Stateful Firewall** page.
2. Enable the firewall settings for the ALGs:
 - a. Select the **Stateful SIP Processing** check box for the SIP ALG.
 - b. Select the **Stateful H.323 Processing** check box for the H.323 ALG.
 - c. Select the **Stateful SCCP Processing** check box for the SCCP ALG.
 - d. Select the **Stateful Vocera Processing** check box for the Vocera ALG.
 - e. Select the **Stateful UA Processing** check box for the NOE ALG.

In the CLI

To enable the firewall settings for the SIP ALG:

```
(host) #configure terminal
(host) (config) #no firewall disable-stateful-sip-processing
```

To enable the firewall settings for the H.323 ALG:

```
(host) (config) #no firewall disable-stateful-h323-processing
```

To enable the firewall settings for the SCCP ALG:

```
(host) (config) #no firewall disable-stateful-sccp-processing
```

To enable the firewall settings for the Vocera ALG:

```
(host) (config) #no firewall disable-stateful-vocera-processing
```

To enable the firewall settings for the NOE ALG:

```
(host) (config) #no firewall disable-stateful-ua-processing
```

Additional Video Configurations

You can configure ArubaOS to reliably and efficiently stream video traffic over wireless LAN (WLAN). This new method allows you to stream video traffic reliably without much loss. To ensure that video data is transmitted reliably dynamic multicast optimization techniques are used.

Although the dynamic multicast optimization conversion generates more traffic, that traffic is buffered by the AP and delivered to the client when the client emerges from power-save mode.

Configuring Video over WLAN enhancements

To configure video over WLAN enhancements, do the following:

- Enable WMM on the SSID profile.
- Enable IGMP proxy or IGMP snooping.
- Configure an ACL to set a DSCP value same as the `wmm-vi-dscp` value in the SSID profile for prioritizing the multicast video traffic.
- Enable dynamic multicast optimization under VAP profile.
- Configure the dynamic multicast optimization threshold—The maximum number of high throughput stations in a multicast group. The optimization will stop if the number exceeds the threshold value.

- Enable multicast rate optimization to support higher data rate for multicast traffic in the absence of dynamic multicast optimization. Dynamic multicast optimization takes precedence over multicast rate optimization up to the configured threshold value.
- Enable video aware scan on ARM profile—This ensures that AP does not scan when a video stream is active.
- Optionally you can configure and apply WMM bandwidth management profile—The total bandwidth share should not exceed 100 percent.
- Enable multicast shaping to shape the bursty traffic from the source.

You can either use CLI or WebUI to configure the video over WLAN enhancements.

Pre-requisites

- You will need the Policy Enforcement Firewall Next Generation (PEFNG) license to enable dynamic multicast optimization.
- This feature is available only on W-7200 Series, W-6000M3, W-3000 Series, and W-600 Series controller platforms.

In the CLI

1. Enable IGMP proxy or IGMP snooping on the controller.

To enable IGMP proxy:

```
(host) (config) #interface vlan 1
(host) (config-subif) #ip igmp proxy gigabitethernet 1/3
```

To enable IGMP snooping

```
(host) (config) #interface vlan 1
(host) (config-subif) #ip igmp snooping
```

2. Enable wireless multimedia and set a DSCP value for video traffic.

```
(host) (config) #wlan ssid-profile default
(host) (ssid-profile "default") #wmm
(host) (ssid-profile "default") #wmm-vi-dscp <value>
```

Example:

```
(host) (ssid-profile "default") #wmm-vi-dscp 40
(host) (SSID Profile "default") #show wlan ssid-profile default
```

```
SSID Profile "default"
```

```
-----
```

Parameter	Value
-----	-----
SSID enable	Enabled
ESSID	building1-ap
...	
...	
...	
Wireless Multimedia (WMM)	Enabled
Wireless Multimedia U-APSD (WMM-UAPSD) Powersave	Enabled
WMM TSPEC Min Inactivity Interval	0 msec
Override DSCP mappings for WMM clients	Disabled
DSCP mapping for WMM voice AC	56
DSCP mapping for WMM video AC	40
...	
...	
...	

Setting the DSCP value, tags the content as video stream that the APs can recognize.

3. Create an ACL on the controller with the values equivalent to the DSCP mappings to prioritize the video traffic.

Example: The following ACL prioritizes the multicast traffic from the specified multicast group on the controller. You can also add this ACL to any user role or port.

```
(host) (config-sess-mcast_video_acl)#any network 224.0.0.0 255.0.0.0 any permit tos 40
queue high 802.1p 5
```

a. To add the ACL to a user role:

```
(host) (config) #user-role authenticated access-list session mcast_video_acl
```

This example uses the user role, *authenticated*.

b. To add the ACL to a port:

```
(host) (config) #interface gigabitethernet 1/3
(host) (config-if) #ip access-group mcast_video_acl session
```

4. Configure dynamic multicast optimization for video traffic on a virtual AP profile.

```
(host) (config)#wlan virtual-ap default
(host) (Virtual AP Profile "default")#dynamic-mcast-optimization
(host) #show wlan virtual-ap default
Virtual AP profile "default"
-----
Parameter                               Value
-----
Virtual AP enable                         Enabled
...
...
Blacklist Time                           3600 sec
Dynamic Multicast Optimization for Video  Enabled
Dynamic Multicast Optimization Threshold 6
...
...
```

5. Configure the dynamic multicast optimization threshold value.

```
(host) (config) #dynamic-mcast-optimization-thresh 6
(host) #show wlan virtual-ap default
Virtual AP profile "default"
-----
Parameter                               Value
-----
Virtual AP enable                         Enabled
Allowed band                             all
...
...
Blacklist Time                           3600 sec
Dynamic Multicast Optimization for Video  Enabled
Dynamic Multicast Optimization Threshold 6
Authentication Failure Blacklist Time    3600 sec
...
...
...
```

6. Configure multicast rate optimization for video traffic.

```
(host) (config) #wlan ssid-profile default
(host) (SSID Profile "default") #mcast-rate-opt
(host) (SSID Profile "default") #show wlan ssid-profile default
SSID Profile "default"
-----
Parameter                               Value
-----
SSID enable                              Enabled
ESSID                                     building1-ap
Encryption                               opensystem
```

```

DTIM Interval                1 beacon periods
802.11a Basic Rates          6 12 24
...
...
...
EDCA Parameters Station profile    N/A
EDCA Parameters AP profile         N/A
BC/MC Rate Optimization           Enabled
Strict Spectralink Voice Protocol (SVP)  Disabled
...
...
...

```

7. Configure ARM scanning for video traffic.

In the default RF ARM profile, enable the video aware scan option. This prevents APs from scanning when a video traffic is active.

```

(host) (config) #rf arm-profile default
(host) (Adaptive Radio Management (ARM) profile "default") #video-aware-scan
(host) (Adaptive Radio Management (ARM) profile "default") #end
(host) #show rf arm-profile default

```

```

Adaptive Radio Management (ARM) profile "default"
-----

```

Parameter	Value
Assignment	single-band
Allowed bands for 40MHz channels	a-only
Client Aware	Enabled
...	
...	
...	
Scanning	Enabled
Scan Time	110 msec
VoIP Aware Scan	Disabled
Power Save Aware Scan	Enabled
Video Aware Scan	Enabled
...	
...	
...	
Load aware Scan Threshold	1250000 Bps
Mode Aware Arm	Disabled

8. Configure and apply a bandwidth management profile.

```

(host) (config)# wlan wmm-traffic-management-profile default

```



NOTE: Ensure that you configure the WMM traffic management profile to the virtual AP profile if you have configured the virtual AP traffic management profile.

a. Enable a bandwidth shaping policy so that the allocated bandwidth share is appropriately used.

```

(host) (WMM Traffic management profile "default") # enable-shaping

```

b. Set a bandwidth percentage for the following categories:

```

(host) (WMM Traffic management profile "default") # background 10
(host) (WMM Traffic management profile "default") # best-effort 20
(host) (WMM Traffic management profile "default") # video 50
(host) (WMM Traffic management profile "default") # voice 20
(host) (WMM Traffic management profile "default") # show wlan wmm-traffic-management-profile default

```

```
WMM Traffic management profile "default"
```

```
-----  
Parameter          Value  
-----  
Enable Shaping Policy true  
Voice Share         20 %  
Video Share         50 %  
Best-effort Share   20 %  
Background Share    10 %
```

After you configure the WMM bandwidth management profile, apply it to the virtual AP profile.

```
(config) #wlan virtual-ap default  
(Virtual AP profile "default") #wmm-traffic-management-profile default
```

9. Enable multicast shaping on the firewall.

```
(host) (config) #firewall shape-mcast  
(host) (config) #show firewall
```

```
Global firewall policies  
-----
```

Policy	Action	Rate	Slot/Port
-----	-----	----	-----
Enforce TCP handshake before allowing data	Disabled		
Prohibit RST replay attack	Disabled		
...			
...			
Multicast automatic shaping	Enabled		
Clear Sessions on Role Update	Disabled		
Session mirror IPSEC	Disabled		

In the WebUI

1. Enable IGMP proxy or IGMP snooping on the controller.

To enable IGMP proxy:

- Navigate to the **Configuration > Network > IP** page. Under the **IGMP** settings, select the **Enable IGMP** checkbox.
- Select the **Proxy** checkbox and select the appropriate value from the **Interface** drop down menu.
- Click the **Apply** button to apply the settings and save the configurations.

Figure 288: Enable IGMP Proxy

IGMP	
Enable IGMP	<input checked="" type="checkbox"/>
Snooping	<input type="checkbox"/>
Proxy	<input checked="" type="checkbox"/> Interface: Gigabitethernet 1/0 ▾

To enable IGMP snooping:

- Navigate to the **Configuration > Network > IP** page. Under the **IGMP** settings, select the **Enable IGMP** checkbox.
- Select the **Snooping** checkbox.
- Click the **Apply** button to apply the settings and save the configurations.

Figure 289: Enable IGMP Snooping

IGMP	
Enable IGMP	<input checked="" type="checkbox"/>
Snooping	<input checked="" type="checkbox"/>
Proxy	<input type="checkbox"/> Interface GigabitEthernet 1/0

2. Enable wireless multimedia and set a DSCP value for video traffic.
 - a. Navigate to the **Configuration > Advanced Services > All Profiles** page.
 - b. Under the **Profiles** column, expand **Wireless LAN > SSID Profile** and select the profile name.
This example uses the *default* profile.
 - c. Click the **Advanced** tab and select the **Wireless Multimedia (WMM)** checkbox.
 - d. Enter the DSCP value (integer number) in the **DSCP mapping for WMM video AC** field and click the **Apply** button.

Figure 290: Enable Wireless Multimedia and Set DSCP Value

Max Transmit Attempts	8	RTS Threshold	2333	bytes
Short Preamble	<input checked="" type="checkbox"/>	Max Associations	64	
Wireless Multimedia (WMM)	<input checked="" type="checkbox"/>	Wireless Multimedia U-APSD (WMM-UAPSD) Powersave	<input checked="" type="checkbox"/>	
WMM TSPEC Min Inactivity Interval	0	Override DSCP mappings for WMM clients	<input type="checkbox"/>	msec
DSCP mapping for WMM voice AC	56	DSCP mapping for WMM video AC	40	
DSCP mapping for WMM best-effort AC	24	DSCP mapping for WMM background AC	8	
Hide SSID	<input type="checkbox"/>	Deny_Broadcast Probes	<input type="checkbox"/>	
Local Probe Request Threshold (dB)	0	Disable Probe Retry	<input checked="" type="checkbox"/>	

3. Create an ACL on the controller with the values equivalent to the DSCP mappings to prioritize the video traffic.
 - a. Navigate to the **Configuration > Security > Access Control** page and click the **Policies** tab.
 - b. Click the **Add** button to create a new policy.
 - c. Enter the appropriate values under **Rules** to match the DSCP mapping values.

Figure 291: Set ACL to Prioritize Video Traffic

Source	Destination	Service	Action	Log	Mirror	Queue	Time Range	Pause ARM Scanning	BlackList	TOS	802.1p Priority	Action
any	mcast_subnet	any	permit			High		Yes		40	5	Delete ▲ ▼
any	any	any	permit			Low						Delete ▲ ▼

Add

You can also add this ACL to any user role or port.

To apply the ACL to a user role:

- a. Navigate to the **Configuration > Security > Access Control** page and click the **User Roles** tab.
- b. Edit the user role and click the **Add** button under Firewall Policies.
- c. Select the ACL from the **Choose From Configured Policies** drop down and click the **Done** button.
- d. Click the **Apply** button to save the configurations.

Figure 292: Apply ACL to User Role

Name	Firewall Policies
authenticate4d	Not Configured
authenticated	mcast_video_acl/,allowall/,v6-allowall/
authenticated_conf	authenticated_http_https_proxy_acl/,allowall/,v6-allowall/
default-vpn-role	allowall/,v6-allowall/
guest	http-acl/,https-acl/,dhcp-acl/,icmp-acl/,dns-acl/,v6-http-acl/,v6-https-acl/,v6-dhcp-acl/,v6-icmp-acl/,v6-dns-acl/
guest-logon	logon-control/,captiveportal/

To apply the ACL to a port:

- a. Navigate to the **Configuration > Network > Port** page and select the upstream port.
- b. Under the **VLAN Firewall Policy** drop down, select the ACL.
- c. Click the **Apply** button to save the configurations.

Figure 293: Apply ACL to Port

VLAN ID	1
Trusted	<input checked="" type="checkbox"/>
VLAN Firewall Policy	mcast_video

4. Configure dynamic multicast optimization for video traffic on a virtual AP profile.

Under the **Profiles** column, expand **Wireless LAN > Virtual AP Profile** and select the profile name. This example uses the *default* profile. In the **Profile Details** section, select the **Dynamic Multicast Optimization (DMO)** option and enter the threshold value.

Figure 294: Enabling Dynamic Multicast Optimization for Video and Set Threshold

Virtual AP profile > default		Show Reference	Save As	Reset
Virtual AP enable	<input checked="" type="checkbox"/>	Allowed band	all	
VLAN	<-- --NONE--	Forward mode	decrypt-tunnel	
Deny time range	--NONE--	Mobile IP	<input checked="" type="checkbox"/>	
HA Discovery on-association	<input type="checkbox"/>	DoS Prevention	<input type="checkbox"/>	
Station Blacklisting	<input checked="" type="checkbox"/>	Blacklist Time	3600	sec
Dynamic Multicast Optimization (DMO)	<input checked="" type="checkbox"/>	Dynamic Multicast Optimization (DMO) Threshold	6	
Authentication Failure Blacklist Time	3600	Multi Association	<input type="checkbox"/>	
Strict Compliance	<input type="checkbox"/>	VLAN Mobility	<input type="checkbox"/>	
Remote-AP Operation	standard	Drop Broadcast and Multicast	<input type="checkbox"/>	
Convert Broadcast ARP requests to unicast	<input type="checkbox"/>	Band Steering	<input type="checkbox"/>	

5. Configure multicast rate optimization for the video traffic.
 - a. Navigate to the **Configuration > Advanced Services > All Profiles** page.
 - b. Under the **Profiles** column, expand **Wireless LAN > SSID Profile** and select the profile name.
 - c. Click the **Advanced** tab and select the **BC/MC Rate Optimization** checkbox.
 - d. Click the **Apply** button to save the configurations.

Figure 295: Enable Multicast Rate Optimization

Maximum Transmit Failures	0	BC/MC Rate Optimization	<input checked="" type="checkbox"/>
Strict Spectralink Voice Protocol (SVP)	<input type="checkbox"/>	802.11g Beacon Rate	default
802.11a Beacon Rate	default		

6. Configure ARM scanning for video traffic.

Under the **Profiles** column, expand **RF Management > Adaptive Radio Management (ARM) Profile** and select the profile name. This example uses the *default* profile. Select the **Video Aware Scan** option and click the **Apply** button.

Figure 296: Enabling Video Aware Scan

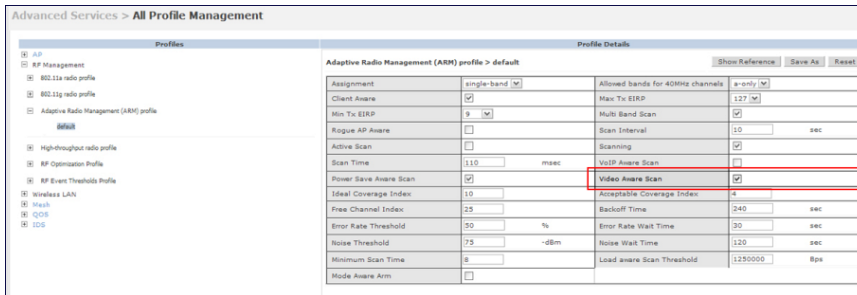

7. Configure and apply bandwidth management profile

Under the **Profiles** column, expand **Virtual AP > [profile-name] > WMM Traffic Management Profile**. In the **Profile Details** section, select the profile name from the drop down list box. Select the **Enable Shaping Policy** option and enter the bandwidth share values. Click the **Apply** button to save the settings.

This step is optional.



NOTE: Ensure that you configure the WMM traffic management profile to the virtual AP profile if you have configured the virtual AP traffic management profile.

Figure 297: Configuring bandwidth management

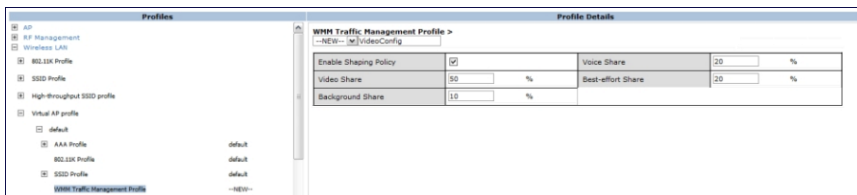

After you configure the WMM bandwidth management profile, apply it to the virtual AP profile.

8. Enable multicast shaping on the firewall.

- a. Navigate to the **Configuration > Advanced Services > Stateful Firewall** page.
- b. Click the **Global Setting** tab and select the **Multicast automatic shaping** checkbox.
- c. Click the **Apply** button to save the configurations.

Figure 298: Enable Firewall Multicast Shaping

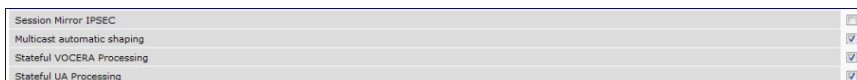

Working with QoS for Voice and Video

QoS settings for voice and video applications are configured when you configure firewall roles and policies.

Understanding VoIP Call Admission Control Profile

VoIP call admission control prevents any single AP from becoming congested with voice calls. You configure call admission control options in the VoIP Call Admission Control profile which you apply to an AP group or a specific AP.

You can use the WebUI or CLI to configure a VoIP Call Admission Control profile.

In the WebUI

1. Navigate to the **Configuration > AP Configuration** page. Select either AP Group or AP Specific.
 - If you select AP Group, click Edit for the AP group name for which you want to configure VoIP CAC.
 - If you select AP Specific, select the name of the AP for which you want to configure VoIP CAC.
2. In the Profiles list, expand the **QoS** menu, then select the **VoIP Call Admission Control** profile.
3. In the **Profile Details** window pane, click the VoIP Call Admission Control profile drop-down list and select the profile you want to edit.
-or-
To create a new profile, click the **VoIP Call Admission Control** profile drop-down list and select **New**. Enter a new profile name in the field to the right of the drop-down list. You cannot use spaces in VoIP profile names.
4. Configure your desired VoIP Call Admission Control profile settings. [Table 299](#) describes the parameters you can configure in this profile.

Table 299: VoIP Call Admission Control Configuration Parameters

Parameter	Description
VoIP Call Admission Control	Select the Voip Call Admission Control checkbox to enable Wi-Fi VoIP Call Admission Control features.
VoIP Bandwidth based CAC	Select the VoIP Bandwidth based CAC checkbox to enable call admission controls based upon bandwidth. If this option is not selected, call admission controls are based on call counts.
VoIP Call Capacity	The maximum number of simultaneous calls that the AP radio can handle. The default value is 10. You can use the bandwidth calculator in the WebUI to calculate the call capacity. To access the bandwidth calculator, navigate to Configuration > Management > Bandwidth Calculator .
VoIP Bandwidth Capacity (kbps)	Enter a rate from 1 to 600000 (inclusive) to specify the maximum bandwidth rate that a radio can handle, in kbps. The default value is 2000 kbps.
VoIP Call Handoff Reservation	Specify the percentage of call capacity reserved for mobile VoIP clients on an active call. The default value is 20%.
VoIP Send SIP 100 Trying	The SIP invite call setup message is time-sensitive, as the originator retries the call as quickly as possible if it does not proceed. You can direct the controller to immediately reply to the call originator with a "SIP 100 - trying" message to indicate that the call is proceeding and to avoid a possible timeout. This is useful in conditions where the SIP invite may be redirected through a number of servers before reaching the controller. Select the VoIP Send SIP 100 Trying checkbox to send <i>SIP 100-trying</i> messages to a call originator to indicate that the call is proceeding. This is a useful option when the SIP invite is directed through many servers before reaching the controller.
VoIP Disconnect Extra Call	In the VoIP Call Admission Control (CAC) profile, you can limit the number of active voice calls allowed on a radio. This feature is disabled by default. When the

Parameter	Description
	disconnect extra call feature is enabled, the system monitors the number of active voice calls, and if the defined threshold is reached, any new calls are disconnected. The AP denies association requests from a device that is on call. To enable this feature, select the VoIP Disconnect Extra Call checkbox. You also need to enable call admission control in this profile.
VOIP TSPEC Enforcement	A WMM client can send a Traffic Specification (TSPEC) signaling request to the AP before sending traffic of a specific AC type, such as voice. You can configure the controller so that the TSPEC signaling request from a client is ignored if the underlying voice call is not active; this feature is disabled by default. If you enable this feature, you can also configure the time duration within which the station should start the voice call after sending the TSPEC request (the default is one second). Select the VoIP TSPEC Enforcement checkbox to validate TSPEC requests for CAC.
VOIP TSPEC Enforcement Period	Select the maximum time, in seconds, for the station to start the call after the TSPEC request.
VoIP Drop SIP Invite and send status code (client)	Click the VoIP Drop SIP Invite and send status code (client) drop-down list and select one of the following status codes to be sent back to the client: <ul style="list-style-type: none"> ● 480: Temporary Unavailable ● 486: Busy Here ● 503: Service Unavailable ● none: Don't send SIP status code
VoIP Drop SIP Invite and send status code (server)	Click the VoIP Drop SIP Invite and send status code (client) drop-down list and select one of the following status codes to be sent back to the server: <ul style="list-style-type: none"> ● 480: Temporary Unavailable ● 486: Busy Here ● 503: Service Unavailable ● none: Don't send SIP status code

5. Click **Apply** to save your settings.

In the CLI

```
wlan voip-cac-profile <profile>
  bandwidth-cac
  bandwidth-capacity <bandwidth-capacity>
  call-admission-control
  call-capacity
  call-handoff-reservation <percent>
  disconnect-extra-call
  send-sip-100-trying
  send-sip-status-code client|server <code>
  wmm-tspec-enforcement
  wmm-tspec-enforcement-period <seconds>
```

Understanding Wi-Fi Multimedia

Wi-Fi Multimedia (WMM), is a Wi-Fi Alliance specification based on the IEEE 802.11e wireless Quality of Service (QoS) standard. WMM works with 802.11a, b, g, and n physical layer standards.

WMM supports four access categories (ACs): voice, video, best effort, and background. [Table 300](#) shows the mapping of the WMM access categories to 802.1p priority values. The 802.1p priority value is contained in a two-byte QoS control field in the WMM data frame.

Table 300: WMM Access Category to 802.1p Priority Mapping

Priority	802.1p Priority	WMM Access Category
	1	Background
	2	
	0	Best effort
	3	
	4	Video
	5	
	6	Voice
Highest	7	

In non-WMM, or hybrid environments where some clients are not WMM-capable, Dell uses voice and best effort to prioritize traffic from these clients.

Unscheduled Automatic Power Save Delivery (U-APSD) is a component of the IEEE 802.11e standard that extends the battery life on voice over WLAN devices. When enabled, clients trigger the delivery of buffered data from the AP by sending a data frame.

For the environments in which the wireless clients support WMM, you can enable both WMM and U-APSD in the SSID profile.

Enabling WMM

You can use the WebUI or CLI to enable WMM for wireless clients.

In the WebUI

1. Navigate to the **Configuration > Wireless > AP Configuration** page.
2. Select either the AP Group or AP Specific tab. Click **Edit** for the AP group or AP name.
3. In the Profiles list, select **Wireless LAN**. Select **Virtual AP**, then select the applicable virtual AP profile. Select the SSID profile.
4. In the **Profile Details**, select the **Advanced** tab.
5. Select the **Wireless Multimedia (WMM)** option. Or, select the **Wireless Multimedia U-APSD (WMM-UAPSD) Powersave** option if you want to enable WMM in power save mode.
6. Click **Apply**.

In the CLI

```
wlan ssid-profile <profile> wmm  
wlan ssid-profile <profile> wmm-uapsd
```

Configuring WMM AC Mapping

The IEEE 802.11e standard defines the mapping between WMM ACs and Differentiated Services Codepoint (DSCP) tags. The WMM AC mapping commands allow you to customize the mapping between WMM ACs and DSCP tags to prioritize various traffic types. You apply and configure WMM AC mappings to a WMM-enabled SSID profile.



Ensure that WMM is enabled for legacy APs for the mapping to take effect. For 802.11n APs, ensure that either WMM or high throughput is enabled.

DSCP classifies packets based on network policies and rules, not priority. The configured DSCP value defines per hop behaviors (PHBs). The PHB is a 6-bit value added to the 8-bit Differentiated Services (DS) field of the IP packet header. The PHB defines the policy and service applied to a packet when traversing the network. You configure these services in accordance with your network policies. Table 301 shows the default WMM AC to DSCP decimal mappings and the recommended WMM AC to DSCP mappings.

Table 301: WMM Access Category to DSCP Mappings

DSCP Decimal Value	WMM Access Category
8	Background
16	
0	Best effort
24	
32	Video
40	
48	Voice
56	

By customizing WMM AC mappings, both the controller and AP maintain a customized WMM AC mapping table for each configured SSID profile. All packets received are matched against the entries in the mapping table and prioritized accordingly. The mapping table contains information for upstream (client to AP) and downstream (AP to client) traffic.

NOTE: In earlier releases, the default mappings exist for all SSIDs. After you customize a WMM AC mapping and apply it to the SSID, the controller overwrites the default mapping values and uses the configured values. If a controller is upgraded to 6.2 from an older version, the default as well as the user configured WMM-DSCP mappings in the existing SSID profiles are retained. There are no default mappings for a newly created SSID profile and for a factory default controller running 6.2 image.



When planning your mappings, make sure that any immediate switch or router does not have conflicting 802.1p or DSCP configurations/mappings. If this occurs, your traffic may not be prioritized correctly.

To view the mapping settings, use the following command:

```
show wlan ssid-profile <profile>
```

Using the WebUI to map between WMM AC and DSCP

1. Navigate to the **Configuration > Wireless > AP Configuration** page.
2. Select either the AP Group or AP Specific tab. Click **Edit** for the AP group or AP name.
3. In the Profiles list, select **Wireless LAN**. Select **Virtual AP**, then select the applicable virtual AP profile. Select the SSID profile.
4. In the Profile Details, select the Advanced tab.
5. Scroll down to the Wireless Multimedia (WMM) option. Select (check) this option.
6. Modify the DSCP mapping settings, as needed:

- DSCP mapping for WMM voice AC—DSCP used to map voice traffic
- DSCP mapping for WMM video AC—DSCP used to map video traffic
- DSCP mapping for WMM best-effort AC—DSCP used to map best-effort traffic
- DSCP mapping for WMM background AC—DSCP used to map background traffic

7. Click **Apply**.

The following enhancements have been made to the WMM-DSCP mapping functionality:

- When a controller is upgraded to 6.2 version from an older version, the default as well as the user configured WMM-DSCP mappings in the existing SSID profiles are retained.
- Default mappings are not there for a newly created SSID profile and for a factory default controller running 6.2 image.
- If the mapping has no value, the original DSCP for upstream traffic is retained.
- The maximum number of values that can be configured for WMM-DSCP is 8.
- For the upstream traffic, if the mapping exists and incoming DSCP value matches one of the mapped values then the DSCP value is retained
- For the upstream traffic, if the mapping exists and incoming DSCP value does not match any of the mapped values then the DSCP value is overwritten with the first value in the WMM- DSCP list
- For Wireless to Wireless Traffic: If the AC of the incoming packet has no mapping and the incoming DSCP value is mapped to a different AC, then the DSCP value is retained and WMM priority is changed to the corresponding AC where incoming DSCP is mapped.

Using the CLI to map between WMM AC and DSCP

```
wlan ssid-profile <profile>
  wmm-be-dscp <best-effort>
  wmm-bk-dscp <background>
  wmm-vi-dscp <video>
  wmm-vo-dscp <voice>
```

Configuring DSCP Priorities

You can configure DSCP priorities for WMM packets in the following ways:

- Configure the DSCP mappings in the SSID profile
- Set a ToS value in the ACL
- Set the ToS value as well as the 802.1p priority in the ACL

Setting a ToS value in the ACL overrides the default DSCP mappings configured in the SSID profile. Configuring a DSCP priority in both the L2 and L3 header prioritizes the WMM packets with the higher value.

For example, we can have different ToS values set for different voice traffic in a network. To prioritize all of them in the voice queue, we can set the 802.1p priority to voice.

Consider a deployment where Cisco Softphone, Lync, and Scopia are configured with the following DSCP :

- Cisco Softphone - DSCP 46
- Lync - DSCP 44
- Scopia - DSCP 42

In the absence of doing anything, all of the DSCP above would map into the Video queue. To map all the traffic into Voice queue you can do the following ACL configuration:

```
wlan ssid-profile VOICE
  wmm-vo-dscp 46
ip access-list session VOICE
```

```
any destination [LYNC_SERVER] [LYNC_PORTS] permit tos 44 dot1p-priority 6
any destination [SCOPIA_SERVER] [SCOPIA_PORTS] permit tos 42 dot1p-priority 6
```



NOTE: You must know the ports on which each traffic is sent so that the correct traffic is identified.

Configuring Dynamic WMM Queue Management

Traditional wireless networks provide all clients with equal bandwidth access. However, delays or reductions in throughput can adversely affect voice and video applications, resulting in disrupted VoIP conversations or dropped frames in a streamed video. Thus, data streams that require strict latency and throughput need to be assigned higher traffic priority than other traffic types.

The Wi-Fi Alliance defined the Wi-Fi Multimedia (WMM) standard in response to industry requirements for Quality of Service (QoS) support for multimedia applications for wireless networks. This is defined as per the IEEE 802.11e standards.

WMM requires:

- The access point is Wi-Fi Certified and has WMM enabled
- The client device is Wi-Fi Certified
- The application supports WMM

Enhanced Distributed Channel Access

WMM provides media access prioritization through Enhanced Distributed Channel Access (EDCA). EDCA defines four access categories (ACs) to prioritize traffic: voice, video, best effort, and background. These ACs correspond to 802.1p priority tags, as shown in [Table 302](#).

Table 302: WMM Access Categories and 802.1p Tags

WMM Access Category	Description	802.1p Tag
Voice	Highest priority	7, 6
Video	Prioritize video traffic above other data traffic	5, 4
Best Effort	Traffic from legacy devices or traffic from applications or devices that do not support QoS	0, 3
Background	Low priority traffic (file downloads, print jobs)	2, 1

While the WMM ACs designate specific types of traffic, you can determine the priority of the ACs. For example, you can choose to give video traffic the highest priority. With WMM, applications assign data packets to an AC. In the client, the data packets are then added to one of the transmit queues for voice, video, best effort, or background.

WMM is an extension to the Carrier Sense Multiple Access with Collision Avoidance (CSMA/CA) protocol's Distributed Coordination Function (DCF). The collision resolution algorithm responsible for traffic prioritization depends on the following configurable parameters for each AC:

- arbitrary inter-frame space number (AIFSN)
- minimum and maximum contention window (CW) size

For each AC, the backoff time is the sum of the AIFSN and a random value between 0 and the CW value. The AC with the lowest backoff time is granted the opportunity to transmit (TXOP). Frames with the highest-priority AC are more likely to get TXOP as they tend to have the lowest backoff times (a result of having smaller AIFSN and CW parameter values). The value of the CW varies through time as the CW doubles after each collision up to the

maximum CW. The CW is reset to the minimum value after successful transmission. In addition, you can configure the TXOP duration for each AC.

On the controller, you configure the AC priorities in the WLAN EDCA parameters profile. There are two sets of EDCA profiles you can configure:

- AP parameters affect traffic from the AP to the client.
- STA parameters affect traffic from the client to the AP.

Using the WebUI to configure EDCA parameters

Use the following procedure to define an Enhanced Distributed Channel Access (EDCA) profile for APs or for clients (stations).

1. Navigate to the **Configuration > AP Configuration** page. Select either the **AP Group** tab or **AP Specific** tab.
 - If you selected **AP Group**, click **Edit** for the AP group name for which you want to configure EDCA parameters.
 - If you selected **AP Specific**, select the name of the AP for which you want to configure EDCA parameters.
2. Under **Profiles**, expand the **Wireless LAN** menu, then select **Virtual AP**. In the Virtual AP list, select the appropriate virtual AP.
3. Expand the **SSID** profile. Select the **EDCA Parameters Station** or **EDCA Parameters AP** profile.
4. Configure your desired EDCA Profile Parameters. [Table 303](#) describes the parameters you can configure in this profile.

Table 303: EDCA Parameters Station and EDCA Parameters AP Profile Settings

Parameter	Description
Best Effort	Set the following parameters to define the best effort queue. <ul style="list-style-type: none"> • aifsn: Arbitrary inter-frame space number. Possible values are 1-15. • ecw-max: The exponential (n) value of the maximum contention window size, as expressed by 2^n-1. A value of 4 computes to $2^4-1 = 15$. Possible values are 1-15. • ecw-min: The exponential (n) value of the minimum contention window size, as expressed by 2^n-1. A value of 4 computes to $2^4-1 = 15$. Possible values are 0-15. • txop: Transmission opportunity, in units of 32 microseconds. Divide the desired transmission duration by 32 to determine the value to configure. For example, for a transmission duration of 3008 microseconds, enter 94 (3008/32). Possible values are 0-2047. • acm: This parameter specifies mandatory admission control. With a value of 1, the client reserves the access category through traffic specification (TSPEC) signaling. A value of 0 disables this option.
Background	Set the following parameters to define the background queue. <ul style="list-style-type: none"> • aifsn: Arbitrary inter-frame space number. Possible values are 1-15. • ecw-max: The exponential (n) value of the maximum contention window size, as expressed by 2^n-1. A value of 4 computes to $2^4-1 = 15$. Possible values are 1-15. • ecw-min: The exponential (n) value of the minimum contention window size, as expressed by 2^n-1. A value of 4 computes to $2^4-1 = 15$. Possible values are 0-15. • txop: Transmission opportunity, in units of 32 microseconds. Divide the desired transmission duration by 32 to determine the value to configure. For example, for a transmission duration of 3008 microseconds, enter 94 (3008/32). Possible values are 0-2047. • acm: This parameter specifies mandatory admission control. With a value of 1, the client reserves the access category through traffic specification (TSPEC) signaling. A value of 0 disables this option.
Video	Set the following parameters to define the background queue. <ul style="list-style-type: none"> • aifsn: Arbitrary inter-frame space number. Possible values are 1-15.

Parameter	Description
	<ul style="list-style-type: none"> ● ecw-max: The exponential (n) value of the maximum contention window size, as expressed by 2^n-1. A value of 4 computes to $2^4-1 = 15$. Possible values are 1-15. ● ecw-min: The exponential (n) value of the minimum contention window size, as expressed by 2^n-1. A value of 4 computes to $2^4-1 = 15$. Possible values are 0-15. ● txop: Transmission opportunity, in units of 32 microseconds. Divide the desired transmission duration by 32 to determine the value to configure. For example, for a transmission duration of 3008 microseconds, enter 94 (3008/32). Possible values are 0-2047. ● acm: This parameter specifies mandatory admission control. With a value of 1, the client reserves the access category through traffic specification (TSPEC) signaling. A value of 0 disables this option.
Voice	<p>Set the following parameters to define the background queue.</p> <ul style="list-style-type: none"> ● aifsn: Arbitrary inter-frame space number. Possible values are 1-15. ● ecw-max: The exponential (n) value of the maximum contention window size, as expressed by 2^n-1. A value of 4 computes to $2^4-1 = 15$. Possible values are 1-15. ● ecw-min: The exponential (n) value of the minimum contention window size, as expressed by 2^n-1. A value of 4 computes to $2^4-1 = 15$. Possible values are 0-15. ● txop: Transmission opportunity, in units of 32 microseconds. Divide the desired transmission duration by 32 to determine the value to configure. For example, for a transmission duration of 3008 microseconds, enter 94 (3008/32). Possible values are 0-2047. ● acm: This parameter specifies mandatory admission control. With a value of 1, the client reserves the access category through traffic specification (TSPEC) signaling. A value of 0 disables this option.

5. Click **Apply**.

Using the CLI to configure EDCA parameters

```
wlan edca-parameters-profile {ap|station} <profile>
{background | best-effort | video | voice}
[acm][aifsn <number>] [ecw-max <exponent> [ecw-min <exponent>] [txop <number>]
```

To associate the EDCA profile instance to a SSID profile:

```
wlan ssid-profile <profile>
edca-parameters-profile {ap|sta} <profile>
```

Enabling WMM Queue Content Enforcement

WMM queue content enforcement is a firewall setting that you can enable to ensure that the voice priority is used for voice traffic. When this feature is enabled, if traffic to or from the user is inconsistent with the associated QoS policy for voice, the traffic is reclassified to best effort and data path counters incremented. If TSPEC admission were used to reserve bandwidth, then TSPEC signaling is used to inform the client that the reservation is terminated.

You can use the WebUI or CLI to enable WMM queue content enforcement.

In the WebUI

1. Navigate to the **Configuration > Advanced Services > Stateful Firewall** page.
2. Select **Enforce WMM Voice Priority Matches Flow Content**.
3. Click **Apply**.

In the CLI

```
firewall wmm-voip-content-enforcement
```

Understanding Extended Voice and Video Features

This section describes the other voice and video-related functionalities that are available on the controller.

Understanding QoS for Microsoft Office OCS and Apple Facetime

Voice and video devices use a signaling protocol to establish, control, and terminate voice and video calls. These control or signaling sessions are usually permitted using pre-defined ACLs. If, however, the control signaling packets are encrypted, the controller cannot determine which dynamic ports are used for voice or video traffic. In these cases, the controller has to use an ACL with the **classify-media** option enabled to identify the voice or video flow based on a deep packet inspection and analysis of the actual traffic.

Microsoft OCS

Microsoft Office Communications Server (OCS) uses Session Initiation Protocol (SIP) over TLS to establish, control, and terminate voice and video calls. The following example creates an ACL named **ocs** for Microsoft OCS traffic that identifies port 5061 as the reserved SIP-TLS port.

```
(host) (config) #ip access-list session ocs
(host) (config-sess-ocs)#any any tcp 5061 permit position 1 queue high classify-media
(host) (config-sess-ocs)#any any udp 1-65535 permit position 2 queue low
```

Apple Facetime

When an Apple device starts a Facetime video call, it initiates a TCP session to the Apple Facetime server over port 5223, then sends SIP signaling messages over a non-default port. When media traffic starts flowing, audio and video data are sent through that same port using RTP. (The audio and video packets are interleaved in the air, though individual the sessions can be uniquely identified using their payload type and sequence numbers.) The RTP header and payload also get encapsulated under the TURN ChannelData Messages. The Facetime call is terminated with a SIP BYE message that can be sent by either party.

[Table 304](#) lists the ports used by Apple Facetime. Facetime users need to be assigned a role where traffic is allowed on these ports

Table 304: Ports used by the Apple Facetime Application

Port	Packet Type
53	TCP/UDP
443	TCP
3478-3497	UDP
5223	TCP
16384-16387	UDP
16393-16402	UDP

The example below shows how to configure an ACL to identify and monitor Apple Facetime traffic.

```
(host) (config) #ip access-list session facetime
(host) (config-sess-facetime)#any any tcp 80 permit position 1 queue low
(host) (config-sess-facetime)#any any tcp 443 permit position 2 queue low
(host) (config-sess-facetime)#any network 17.0.0.0 255.0.0.0 tcp 5223 permit position 3 queue
low classify-media
(host) (config-sess-facetime)#any any UDP 80 permit position 4 queue low
```

```
(host) (config-sess-facetime)#any network 17.0.0.0 255.0.0.0 UDP 16384-16387 permit position 5 queue low
```

Enabling WPA Fast Handover

In the 802.1x Authentication profile, the WPA fast handover feature allows certain WPA clients to use a pre-authorized PMK, significantly reducing handover interruption. Check with the manufacturer of your handset to see if this feature is supported. This feature is disabled by default.



NOTE: This feature supports WPA clients, while opportunistic key caching (also configured in the 802.1x Authentication profile) supports WPA2 clients.

In the WebUI

1. Navigate to the **Configuration > AP Configuration** page. Select either AP Group or AP Specific.
 - If you select AP Group, click **Edit** for the AP group name for which you want to enable WPA fast handover.
 - If you select AP Specific, select the name of the AP for which you want to enable WPA fast handover.
2. Under **Profiles**, select **Wireless LAN**, then select Virtual AP. In the Virtual AP list, select the appropriate virtual AP instance.
3. Select AAA profile. Select the 802.1x Authentication Profile to display in the Profile Details section.
4. Scroll down to select the WPA-Fast-Handover check box.
5. Click **Apply**.

In the CLI

```
aaa authentication dot1x <profile>  
    wpa-fast-handover
```

For deployments where there are expected to be considerable delays between the controller and APs (for example, in a remote location where an AP is not in range of another Dell AP) you can increase the value for the bootstrap threshold in the AP System profile to minimize the chance of the AP rebooting due to temporary loss of connectivity with the Dell controller.

Enabling Mobile IP Home Agent Assignment

When you enable IP mobility in a mobility domain, the proxy mobile IP module determines the home agent for a roaming client. An option related to voice clients that you can enable allows on-hook phones to be assigned a new home agent to load balance voice client home agents across Dell controllers in the mobility domain. See [IP Mobility on page 492](#) for more information about mobility.

Scanning for VoIP-Aware ARM

ARM scanning on an AP during a call affects the voice quality. You can pause the ARM scanning on the AP when a call is active by turning on the VoIP-Aware ARM Scanning support to avoid voice quality issues.

You can use the WebUI or CLI to enable VoIP-aware ARM scanning in the ARM profile.

In the WebUI

1. Navigate to the **Configuration > AP Configuration** page. Select either the **AP Group** or **AP Specific** tab.
 - If you selected the **AP Group** tab, click the **Edit** button by the name of the AP group with the ARM profile you want to configure.
 - If you selected the **AP Specific** tab, click the **Edit** button by the name of the AP with the ARM profile you want to configure.
2. In the **Profiles** list, Expand the **RF Management** section.

3. Select **Adaptive Radio Management (ARM) Profile**.
4. Select a profile instance from the drop-down menu to edit that profile.
5. Select (check) the **VoIP Aware Scan** option.
6. Click **Apply**.

For additional information on configuring an Adaptive Radio Management profile, see ["Configuring ARM Profiles" on page 348](#).

In the CLI

```
rf arm-profile <profile-name>
  voip-aware-scan
```

Disabling Voice-Aware 802.1x



NOTE: The Voice-Aware 802.1x support is deprecated for ArubaOS 5.0 and later releases.

Although reauthentication and rekey timers are configurable on a per-SSID basis, an 802.1x transaction during a call can affect voice quality. If a client is on a call, 802.1x reauthentication and rekey are disabled by default until the call is completed. You disable or re-enable the “voice aware” feature in the 802.1x authentication profile.

In the WebUI

1. Navigate to the **Configuration > AP Configuration** page. Select either **AP Group** or **AP Specific**.
 - If you select **AP Group**, click **Edit** for the AP group name for which you want to disable voice awareness for 802.1x.
 - If you select **AP Specific**, select the name of the AP for which you want to disable voice awareness for 802.1x.
2. Under **Profiles**, select **Wireless LAN**, then select **Virtual AP**. In the **Virtual AP** list, select the appropriate virtual AP instance.
3. Select **AAA profile**. Select the 802.1x Authentication Profile to display in the **Profile Details** section.
4. Scroll down and deselect the **Disable rekey and reauthentication for clients on call** check box.
5. Click **Apply**.

In the CLI

```
aaa authentication dot1x <profile>
  no voice-aware
```

Configuring SIP Authentication Tracking

The controller supports the stateful tracking of session initiation protocol (SIP) authentication between a SIP client and a SIP registry server. Upon successful registration, a user role is assigned to the SIP client. You specify a configured user role for the SIP client in the AAA profile.

In the WebUI

1. Navigate to the **Configuration > AP Configuration** page. Select either **AP Group** or **AP Specific**.
 - If you select **AP Group**, click **Edit** for the AP group name for which you want to configure the SIP client user role.
 - If you select **AP Specific**, select the name of the AP for which you want to configure the SIP client user role.
2. Under **Profiles**, select **Wireless LAN**, then select **Virtual AP**. In the **Virtual AP** list, select the appropriate virtual AP instance.

3. Select the AAA profile. Enter the configured user role for SIP authentication role.
4. Click **Apply**.

In the CLI

```
aaa profile <profile>
  sip-authentication-role <role>
```

Use the `show voice client-status` command to view the state of the client registration.

Enabling Real Time Call Quality Analysis

Real Time Call Quality Analysis (RTCQA) enables the controller to compute the call quality parameters such as jitter, delay, packet loss, and call quality score (R-value) directly from the RTP media stream. Additionally, the controller saves the periodic samples of the quality parameters for detailed analysis of the results. You can monitor up to 30 active calls that are initiated after enabling RTCQA. You can avail the full benefits of Real Time Call Quality Analysis by setting the AP in the decrypt tunnel mode.

NOTE: Real Time Call Quality Analysis for the voice calls is supported in the following cases:

- when the signaling messages are not encrypted
- when the RTP streams are not encrypted
- when the voice client does not roam from one controller to another controller

You can use the WebUI or CLI to enable Real Time Call Quality Analysis and view the call quality reports based on the analysis.

In the Web UI

1. Navigate to the **Configuration > Advanced services > All Profiles** page.
2. Expand **Other Profiles** under the **Profiles** section and click **Configure Real-Time Analysis**.
3. Enable Real Time call quality analysis for the voice calls by selecting the **Real-Time Analysis of voice calls** check box.

Figure 305: Enable Real Time Analysis

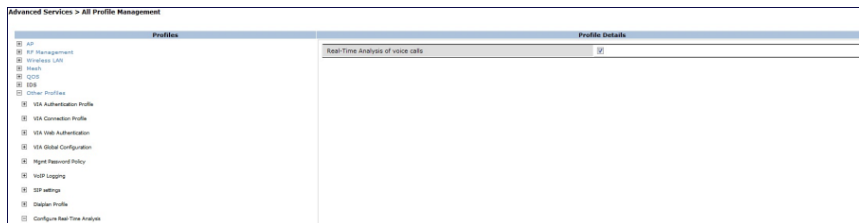

4. Click the **Apply** button to apply the settings and save the configurations.

Viewing Real Time Call Quality Reports

1. To view the average Real Time analysis reports, navigate to the **Monitoring > Voice > Real-Time Quality Analysis** page.
2. To view the detailed Real Time analysis report of a specific client, select the client and click the **View Details** button.

In the CLI

To configure Real Time analysis on voice calls:

```
(host) (config) #voice real-time-config
(host) (Configure Real-Time Analysis) #config-enable
```

To view the average Real Time analysis reports for the voice clients:

```
(host) #show voice real-time-analysis
```

Real-Time Analysis Call Quality Reports

```
-----
Client (IP)      Client (MAC)      Client (Name)  ALG   Jitter (U) (msec)  Pkt-loss (U) (%)  Delay (U)
(usc)  rvalue (U)  Jitter (D) (msec)  Pkt-loss (D) (%)  Delay (D) (usc)  rvalue (D)
-----
10.15.20.52  00:00:f0:05:c9:dc  7811          h323  0.000              0.000             0.000
      NA          0.000              0.000             0.000             NA
10.15.20.63  00:00:f0:05:c9:e3  7812          h323  0.000              0.000             0.000
      NA          0.000              0.000             0.000             NA
Num Records:2
```

To view the detailed Real Time analysis report for a specific client:

```
(host) #show voice real-time-analysis sta 00:1f:6c:7a:d5:30
```

Real-Time Analysis detail report

```
-----
Time           Jitter (U) (msec)  Pkt-loss (U) (%)  Delay (U) (usc)  rvalue (U)  Jitter (D) (msec)
Pkt-loss (D) (%)  Delay (D) (usc)  rvalue (D)
-----
Aug 17 11:55:18  71.000            0.000             0.000           93.360      0.000
0.000            0.000            NA
Aug 17 11:55:13  76.000            0.000             0.000           93.360      0.000
0.000            0.000            NA
Aug 17 11:55:08  69.000            0.000             0.000           93.360      0.000
0.000            0.000            NA
Aug 17 11:55:03  71.000            0.000             0.000           93.360      0.000
0.000            0.000            NA
```

Enabling SIP Session Timer

SIP session timer is implemented in the SIP ALG as per RFC 4028.

SIP session timer defines a keep alive mechanism for the SIP sessions using the periodic session refresh requests from the user agents. The interval for the session refresh requests is determined through a negotiation mechanism. If a session refresh request is not received within the negotiated interval, the session is assumed to be terminated.

For more information on the SIP session timer support, See *section 8.0, Proxy Behaviour* in the RFC 4028.



NOTE: This release of ArubaOS does not support the configurable Min-SE parameter for SIP ALG. Therefore, the ALG will not generate the 422 responses for the session refresh requests.

You can use the WebUI or CLI to enable the SIP session timer and set the session-expiry timer value using the WebUI and CLI.



NOTE: SIP Session Timer can be configured only for SIP over UDP.

In the WebUI

1. Navigate to the **Configuration > Advanced services > All Profiles** page.
2. Expand **Other profiles** under the **Profiles** section and click **SIP Settings**.

3. Enable the session timer by selecting the **Session Timer** check box under the **Profile Details** section.
4. Specify a timeout value in seconds in the **Session Expiry** field. The range is 240 - 1200 seconds. The default value is 300 seconds.

Figure 306: Enabling SIP Session Timer

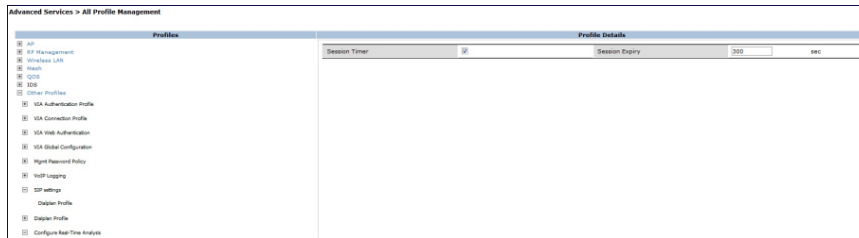

5. Click the **Apply** button to apply the settings and save the configurations.

In the CLI

To configure the session timer and the timeout value:

```
(host) #configure terminal
(host) (config) #voice sip
(host) (SIP settings) #session-timer
(host) (SIP settings) #session-expiry 400
```

To view the SIP settings on the controller:

```
(host) #show voice sip
```

SIP settings

Parameter	Value
Session Timer	Enabled
Session Expiry	400 sec
Dialplan Profile	N/A

Enabling Voice and Video Traffic Awareness for Encrypted Signaling Protocols

The Voice and Video Traffic Awareness for Encrypted Signaling Protocols support enables deep inspection of the traffic established over a secure layer to identify the voice or video sessions. Thus, the controller provides QoS for the voice or video sessions established even over the secure layers such as TLS or IP Sec. For example, the Microsoft Office Communicator uses SIP over TLS for call signaling. You can provide QoS for the voice and video calls through Microsoft Office Communicator by enabling the **Classify Media** option in the SIPS service policy.

You can use the WebUI or CLI for enabling the **Classify Media** option for the encrypted signaling protocols. In our example, we will configure this support for Microsoft Office Communicator.

In the WebUI

1. Navigate to the **Configuration > Security > Access control** page.
2. Click the **Policies** tab.

Figure 307: Firewall Policies Tab

Name	Type	Rule Count	Policy Usage	Action
validuser	session	2		Edit Delete
sys-control	session	10		Edit Delete
sys-ap-ad	session	10		Edit Delete
stateful-datx	session	2		Edit Delete
ap-uplink-ad	session	3		Edit Delete
allow-diskservices	session	4		Edit Delete
control	session	10		Edit Delete
v6-icmp-ad	session	0		Edit Delete
test-techpubs	session	0		Edit Delete
vocera-ad	session	1		Edit Delete

3. Click the Add button to create a new policy.
4. Enter a name for the policy in the Policy Name field and choose Session in the Policy Type drop down menu.
5. Select IPv4 in the IP Version drop down menu and click the Add button.
6. In the Service column, choose service and Select svc-sips (tcp-5061) from the Service drop-down menu.
7. Select the Classify Media check box.



NOTE: There will be a performance impact, if you choose any in the Service column and enable the Classify Media flag for the deep traffic inspection.

Figure 308: Enabling Classify Media

8. Click Apply to apply the settings and save the configurations.

In the CLI

```
(host) (config) #ip access-list session ocs
(host) (config-sess-ocs)#any any tcp 5061 permit classify-media
```

Enabling Wi-Fi Edge Detection and Handover for Voice Clients

Voice clients in an infrastructure can be switched to an alternate carrier or connection when they leave their active Wi-Fi coverage or roam to an area with poor Wi-Fi coverage. The controller uses the best Wi-Fi signal strength (dbm value) reported by the voice clients (received from all APs) to determine if the voice clients are within or leaving their active Wi-Fi connection. If the signal strength is weak, the controller will trigger the handover process to switch the voice client to an alternate carrier or connection. This process ensures QoS for voice calls.



NOTE: ● The handover process is available for voice clients supporting the 802.11K standard and with the ability to transmit and receive beacon reports.

- The voice clients should have dual mode capabilities to ensure that they can switch to an alternate network in case of a loss in Wi-Fi coverage.

The handover process can be configured using the `wlan handover-trigger-profile` command. Use the `handover-threshold` parameter to specify the threshold value (dbm) and enable the `handover-trigger` parameter. If the best

signal strength reported by a voice client is equal to or less than the threshold value, the handover process is initiated.

In the WebUI

1. Navigate to the **Configuration > Advanced Services > All Profiles** page.
2. Expand **Wireless Lan** under the **Profiles** section.
3. Expand 802.11 K profile under Wireless Lan
4. Select the default profile.
5. Select **Advertise 802.1k Capability**.
6. In the profiles list, note which Handover Trigger Feature Settings profile is associated with the selected 80211k profile.
7. Expand **Handover Trigger** under **Wireless Lan**.
8. Select the handover trigger profile associated with the default 802.11k profile.
9. Select the **Enable Handover Trigger feature** checkbox
10. Specify the handover threshold value in the **Threshold signal strength value at which handover Trigger should be sent to the client** field. The handover threshold value should be within the range 20 to 70 dbm. The default threshold value is -60 dbm.
11. Click the **Apply** button to save the configuration.

In the CLI

The following command enables the dot11k profile and sets the handover threshold at -60dbm.

```
(host) (config) #wlan handover-profile default
(host) (802.11K Profile "default") #dot11k-enable
(host) (802.11K Profile "default") #handover-trigger-profile default
(host) (802.11K Profile "default") #exit
(host) (config) #wlan handover-trigger-profile default
(host) (Handover Trigger Profile) #handover-trigger
(host) (Handover Trigger Profile) #handover-threshold 60
```



NOTE: The handover threshold value is a negative dbm value. In the CLI, enter the value without the negative (-) sign.

Working with Dial Plan for SIP Calls

A PSTN call from a SIP device usually requires the user to prefix 9 or 0 before the destination number. You can configure dial plans (prefix codes) on the controller that are required by the local EPABX system to provide outgoing PSTN call facility from a SIP device. After the dial plan is configured, a user can make SIP calls by dialing the destination number without any prefixes.



NOTE: Dial plan can be configured only for SIP over UDP.

Understanding Dial Plan Format

The format of a SIP dial plan is <sequence> <pattern> <action>.

- sequence—is a number between 100 and 65535. The sequence number positions the dial plan in the list of dial plans configured in the controller.

- **pattern**—is the digit pattern or the number of digits that will be dialed by the user. You can specify digit pattern using 'X', 'Z', 'N', '[]', and '.'.
 - X is a wild card that represents any character from 0 to 9.
 - Z is a wild card that represents any character from 1 to 9.
 - N is a wild card that represents any character from 2 to 9.
 - . (period) is a wild card that represents any-length digit strings.
- **action**—is the prefix code that is automatically prefixed to the dialed number. This is specified as <prefix-code>%e. Examples of prefix codes are:
 - 9%e: The number 9 is prefixed to the dialed number.
 - 91%e: The number 91 is prefixed to the dialed number.

Table 309: Examples of Dial Plans

Dialplan Pattern	Action	Description
XXXX	%e	When the user dials a four digit number, no action is taken and the call is allowed.
XXXXXXX	9%e	When the user dials a seven digit number, a nine (9) is prefixed to that number and the call is executed. Example, if the user dials 2274500, the call is executed by adding 9 to the number, 92274500.
XXXXXXXXXX	91%e	This dial plan prefixes 91 to the dialed number. Example, call to 4082274500 will be executed as 914082274500.
+XXXXXXXXXX	9%e	This dial plan replaces '+' with 9 and executes the call. Example, call to +14082274500 is executed as 914082274500.
+	9011%e	This dial plan removes '+' and prefixes 9011 for an international call. Example, call to +886212345678 is executed as 9011886212345678.

Configuring Dial Plans

You can configure a maximum of two dial plan profiles and maximum of 20 dial plans per profile. The dial plan must be associated to a SIP ALG configuration.

To configure a dial plan for SIP devices:

1. Create a voice dial plan
2. Associate the dial plan with SIP ALG

In the WebUI

1. In the WebUI, navigate to **Configuration > Advanced Services > All Profiles > Controller > Dialplan Profile**. Enter a name for the dial plan profile and click the **Add** button.

Figure 310: Dialplan Profile

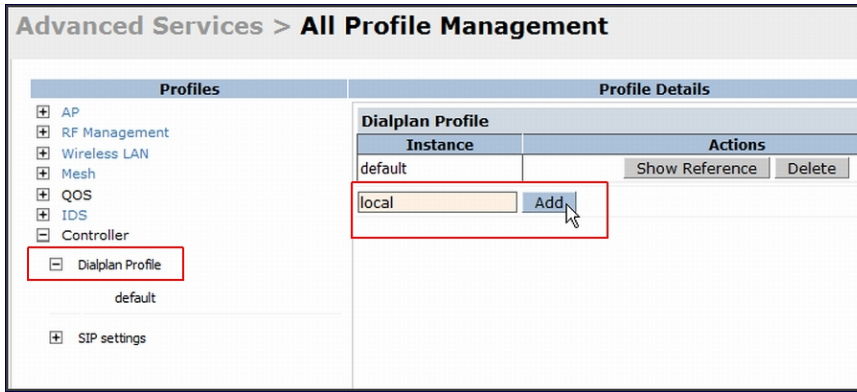

2. Under *Profiles*, expand **Controller** and select the newly created dial plan profile. Enter the following dial plan details and click the **Add** button.
 - Sequence number: The dial plan position in the list of dial plans.
 - Pattern: The number that the user will dial.
 - Action: Prefix to be added by the **controller** before forwarding the call to the EPABX.

Figure 311: Dialplan Details

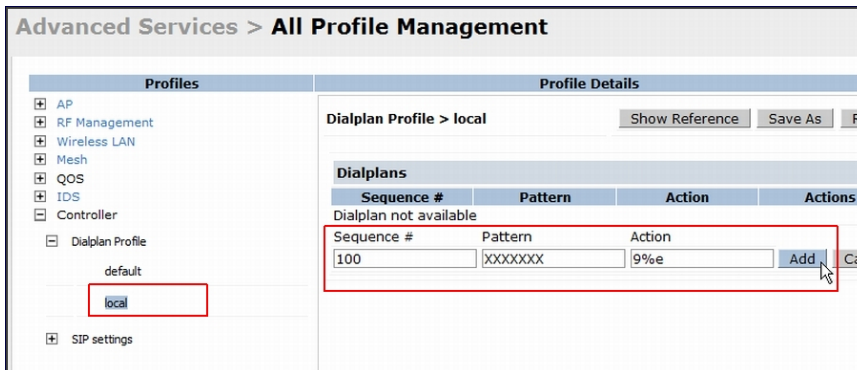

3. Click the **Apply** button to save the configuration.
4. Under *Profile*, navigate to **Controller > SIP settings** and select **Dialplan Profile**. In the *Profile Details* section, select the *Dialplan Profile* from the drop down list and click the **Apply** button.

Figure 312: Select Dialplan Profile

The Dialplan Profile displays the dial plan details:

Figure 313: View Dialplan Details

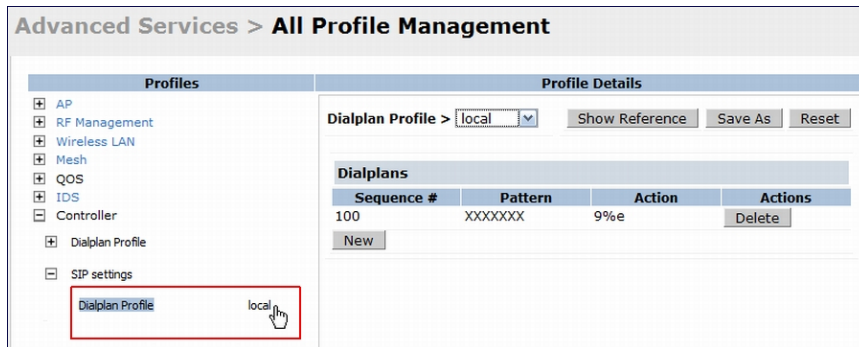

In the CLI

To create a voice dial plan profile:

```
(host) (config) #voice dialplan-profile local
(host) (Dialplan Profile "local") #dialplan 100 XXXXXXXX 9%e
(host) (Dialplan Profile "local") #!
```

To associate the dial plan with SIP ALG:

```
(host) (config) #voice sip
(host) (SIP settings) #dialplan-profile local
(host) (SIP settings) #!
```

To view the SIP dial plan profile:

```
(host) (config) #show voice sip
```

```
SIP settings
-----
Parameter      Value
-----      -
Dialplan Profile local
```

To view the dial plan details:

```
(host) (config) #show voice dialplan-profile local
```

```
Dialplan Profile "local"
-----
Parameter  Value
-----  -
dialplan   100 XXXXXXXX 9%e
```

Enabling Enhanced 911 Support

ArubaOS provides seamless support for emergency calls in the Dell network by interoperating with RedSky emergency call server. The controller uses SNMP to interoperate with RedSky call handling system.



NOTE: This release of ArubaOS supports only RedSky emergency call server.

You must configure the Red Sky server as an SNMP host and enable SNMP traps to activate the E911 feature on the controller. For more information on configuring the RedSky server as SNMP host, see ["Configuring SNMP" on page 639](#).

The E911 support has the following basic functions:

- Location tracking
- Call handling
- Caller identification and callback capability

For information on call-handling, caller identification and callback capability, see the RedSky documentation.

The controller tracks the location of the voice clients and notifies the emergency call server using SNMP traps. The controller notifies the location of a voice client to the emergency server:

- When it identifies a voice client
- When a voice client roams from one access point to another access point in the same controller
- When a voice client roams from one access point to another access point in a different controller
- When a voice client registers with a PBX system

The notification process ensures that the emergency call server is notified whenever a voice client is identified or the location of the client is updated. If a voice client roams outside of a WLAN coverage, the controller does not send any notifications to the emergency call handling system. This may happen when there is a sudden loss of WLAN coverage due to extreme conditions such as, fire accidents. In such cases, the last associated access point will be the location of the voice client.



NOTE: The controller tracks the location only for voice clients. To track the location of a remote voice client, the administrator must configure the location of the remote access point in the controller or emergency call server.

The emergency call server queries the controller using the SNMP 'get' request to get the location of a specific emergency caller. In response to the location query, the controller sends the following parameters to the emergency server:

- Client IP Address
- Client Mac Address
- AP Name
- AP Wired MAC
- AP Location
- AP Mode
- Controller IP Address

The controller also supports location queries for the clients that are not identified as voice clients on the controller.

Working with Voice over Remote Access Point

Voice traffic support is enhanced on split tunnel mode over a remote access point. The voice traffic management for remote and local users are done on the controller. However, the sessions are created differently for both users. For remote users, the sessions are created on the remote access point and for local users, the sessions are created on the controller. This enhancement provides the following support for the voice traffic in the split tunnel over remote access point:

- Voice traffic QoS is consistent for both local and remote users
- All voice ALGs work reliably in split tunnel mode when the PBX traffic is destined to flow through the corporate network.
- Provides voice statistics and counters for remote voice clients in the split tunnel mode

The `flag` parameter in the `show voice client-status` command is updated to indicate remote users.

```
(host) #show voice client-status
Voice Client(s) Status
```

```

-----
AP Name  BSSID          ESSID Client (MAC)      Client (IP)  Client Name  Server (IP)
Registration State  Call Status  ALG  Flags
-----  -
-----  -
moscato 00:0b:11:5c:d6:80 home          00:00:5c:04:b3:10 10.20.1.100
10.13.8.1  REGISTERED      Idle          h323  R
Num Clients:1
Flags:    R - Remote user

```

Client

Understanding Battery Boost

Battery boost is an optional feature that can be enabled for any SSIDs that support voice traffic. This feature converts all broadcast and multicast traffic to unicast before delivery to the client. Enabling battery boost on an SSID allows you to set the DTIM interval from 10 - 100 (the previous allowed values were 1 or 2), equating to 1,000 - 10,000 milliseconds. This longer interval keeps associated wireless clients from activating their radios for multicast indication and delivery, leaving them in power-save mode longer, and thus lengthening battery life. The DTIM configuration is performed on the WLAN, so no configuration is necessary on the client.

An associated parameter available on some clients is the Listening Interval (LI). This defines the interval (in number of beacons) after which the client must wake to read the Traffic Indication Map (TIM). The TIM indicates whether there is buffered unicast traffic for each sleeping client. With battery boost enabled, the DTIM is increased but multicast traffic is buffered and delivered as unicast. Increasing the LI can further increase battery life, but can also decrease client responsiveness.



NOTE: Do not enable battery boost if your network includes Polycom SpectraLink devices that use the Push-to-Talk feature.

You can use the WebUI or CLI to enable the battery boost feature and set the DTIM interval in the SSID profile.

In the WebUI

1. Navigate to the **Configuration > AP Configuration** page. Select either the **AP Group** tab or **AP Specific** tab.
 - If you selected **AP Group**, click **Edit** by the AP group name for which you want to enable battery boost.
 - If you selected **AP Specific**, select the name of the AP for which you want to enable battery boost.
2. Under Profiles, expand **Wireless LAN**, then select **Virtual AP**. In the Virtual AP list, select the appropriate virtual AP instance.
3. In the Profile Details section, select the SSID profile you want to configure.
4. Click the **Advanced** tab.
5. Scroll down the Advanced options and select the **Battery Boost** check box.
6. Scroll up to change the **DTIM Interval** to a longer interval time.
7. Click **Apply**.

In the CLI

```

wlan ssid-profile <profile>
  battery-boost
  dtim-period <milliseconds>

```

Enabling LLDP

Link Layer Discovery Protocol (LLDP), is a Layer-2 protocol that allows network devices to advertise their identity and capabilities on a LAN. Wired interfaces on Dell APs support LLDP by periodically transmitting LLDP Protocol

Data Units (PDUs) comprised of selected type-length-value (TLV) elements. For a complete list of supported, see [Table 315](#) and [Table 317](#).

LLDP-MED (media endpoint devices) is an extension to LLDP that supports interoperability between VoIP and video streaming devices and other networking clients. LLDP-MED network policy discovery lets end-points and network devices advertise the VLAN, priority levels, and DSCP values used by a voice or video application.

In the WebUI

Use the procedure below to configure the LLDP and LLDP-MED profiles and select the TLVs to be sent by the AP.

- Navigate to the **Configuration > AP Configuration** page. Select either the **AP Group** tab or **AP Specific** tab.
 - If you selected **AP Group**, click **Edit** by the AP group name for which you want to enable LLDP.
 - If you selected **AP Specific**, select the name of the AP for which you want to enable LLDP.
- In the **Profiles** window, expand **AP**, then expand the **Ethernet interface port configuration** profile for the port for which you want to configure LLDP.
- Select the **AP LLDP Profile**.

Figure 314: AP LLDP Profile Details

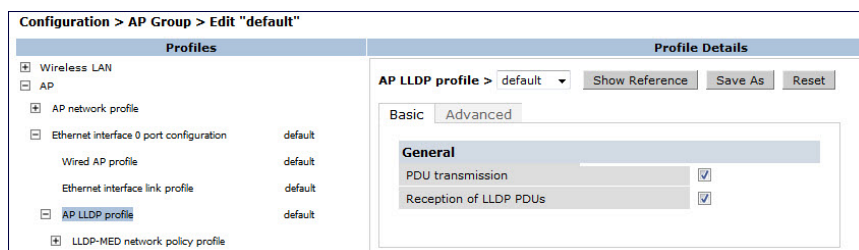

- The AP LLDP profile is divided into two tabs, **Basic** and **Advanced**. The **Basic** tab displays only those configuration settings that often need to be adjusted to suit a specific network. The **Advanced** tab shows all configuration settings, including settings that do not need frequent adjustment or should be kept at their default values. If you change a setting on one tab then click and display the other tab without saving your configuration, that setting will revert to its previous value. Both basic and advanced settings are described in [Table 162](#).
- Configure the LLDP profile parameters as desired then click

Table 315: LLDP Profile Configuration Parameters

Parameter	Description
Basic Settings	
PDU Transmission	Select this checkbox to enable LLDP PDU Transmission. PDU Transmission is enabled by default.
Reception of LLDP PDUs	Select this checkbox to enable LLDP PDU Reception. PDU Reception is enabled by default.
Advanced Settings	
Transmit Interval (seconds)	The interval between LLDP TLV transmission seconds. The supported range is 1-3600, seconds and the default value is 30 seconds.
Transmit hold multiplier	The Transmit hold multiplier is a value that is multiplied by the transmit interval to determine the number of seconds to cache learned LLDP information before that

Parameter	Description
	<p>information is cleared.</p> <p>If the Transmit hold multiplier value is set at its default value of 4, and the Transmit interval is at its default value of 30 seconds, then learned LLDP information will be cached for 4 x 30 seconds, or 120 seconds.</p>
Optional TLVs	<p>Click the checkboxes in this section to select the optional TLVs the AP interface sends in LLDP PDUs. The AP will send all optional TLVs by default.</p> <ul style="list-style-type: none"> ● port-description: Transmit a TLV that gives a description of the AP's wired port in an alphanumeric format. ● system-description: Transmit a TLV that describes the AP's model number and software version. ● system-name: Transmit a TLV that sends the AP name or wired MAC address. ● capabilities: Transmit the system capabilities TLV to indicate which capabilities are supported by the AP. ● management-address: Transmit a TLV that indicates the AP's management IP address, in either IPv4 or IPV6 format.
802.1 TLVs	<p>Click the checkboxes in this section to select the 802.1 TLVs the AP interface sends in LLDP PDUs. The AP will send all 802.1 TLVs by default.</p> <ul style="list-style-type: none"> ● port-vlan: Transmit the LLDP 802.1 port VLAN TLV. If the native VLAN is configured on the port, the port-vlan TLV will send that value, otherwise it will send a value of "0". ● vlan-name: Transmit the LLDP 802.1 VLAN name TLV. The AP sends a value of "Unknown" for VLAN 0, or "VLAN <number>" for all non-zero VLAN numbers.
802.3 TLVs	<p>Click the checkboxes in this section to select the 802.3 TLVs the AP interface sends in LLDP PDUs. The AP will send all 802.3 TLVs by default.</p> <ul style="list-style-type: none"> ● mac: Transmit the 802.3 MAC/PHY Configuration/Status TLV to indicate the AP interface's duplex and bit rate capacity and current duplex and bit rate settings. ● link-aggregation: Transmit the 802.3 link aggregation TLV to indicate that link aggregation is not supported. ● mfs: Transmit the 802.3 Maximum Frame Size (MFS) TLV to show the AP's maximum frame size capability. ● power: Transmit the 802.3 Power Via media dependent interface (MDI) TLV to show the power support capabilities of the AP interface. <p>This parameter is supported by the W-AP130 Series only.</p>
LLDP-MED TLVs	<p>Once you have associated an LLDP-MED Network policy profile with this LLDP profile, you can click the checkboxes in this section to select the LLDP-MED TLVs the AP interface sends in LLDP PDUs. The AP does not send any LLDP-MED TLVs by default.</p> <ul style="list-style-type: none"> ● capabilities: Transmit the LLDP-MED capabilities TLV. The AP will automatically send this TLV if it sends any other LLDP-MED TLVs. ● inventory: Transmit the LLDP-MED inventory TLV. ● network-policy: Transmit the LLDP-MED network-policy TLV. <p>NOTE: The TLVs in this section cannot be enabled unless you have associated an LLDP-MED Network policy profile</p>

6. **Apply** to save your settings.
7. To associate an LLDP-MED network policy profile with the LLDP profile and select the LLDP-MED TLVs to be sent by the AP interface, click the **LLDP-MED network policy profile** that appears below the AP LLDP profile in the profile list.

Figure 316: AP LLDP Profile Details

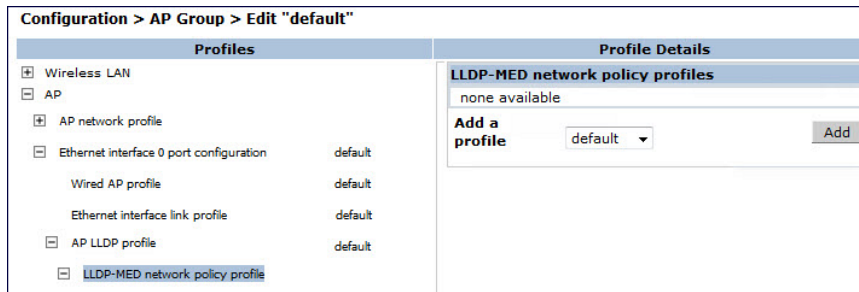

8. If the LLDP profile does not currently reference an LLDP-MED profile, you must associate an LLDP-MED profile with the LLDP profile before you can configure any LLDP-MED settings. Click the **Add a profile** drop-down list in the **Profile Details** window.
 - To associate an existing LLDP-MED network policy, click an LLDP-MED policy name then click **Add**.
 - To create a new LLDP-MED policy, click **NEW**, enter a name for the LLDP-MED network policy, then click **Add**.
9. Click **Apply** to save your settings.
10. Next, expand the LLDP-MED network policy profile in the profiles list, and select the profile you want to configure.
11. The LLDP-MED network policy profile is divided into two tabs, **Basic** and **Advanced**. The **Basic** tab displays only those configuration settings that often need to be adjusted to suit a specific network. The **Advanced** tab shows all configuration settings, including settings that do not need frequent adjustment or should be kept at their default values. If you change a setting on one tab then click and display the other tab without saving your configuration, that setting will revert to its previous value. Both basic and advanced settings are described in [Table 317](#).
12. Configure the LLDP-MED profile parameters as desired then click

Table 317: LLDP-MED Profile Configuration Parameters

Parameter	Description
Basic Settings	
LLDP-MED application type	<p>Click the LLDP-MED application type drop-down list and select the application type managed by this profile.</p> <ul style="list-style-type: none"> • guest-voice: Select this application type if the AP services a separate voice network for guest users and visitors. • guest-voice-signaling: Select this application type if the AP is part of a network that requires a different policy for guest voice signaling than for guest voice media. Do not use this application type if both the same network policies apply to both guest voice and guest voice signaling traffic. • softphone-voice: Select this application type if the AP supports voice services using softphone software applications on devices such as PCs or laptops. • streaming-video: Select this application type if the AP supports broadcast or multicast video or other streaming video services that require specific network policy treatment. This application type is not recommended for video applications that rely on TCP with buffering. • video-conferencing: Select this application type if the AP supports video conferencing equipment that provides real-time, interactive video/audio services. • video-signaling: Select this application type if the AP is part of a network that requires a different policy for video signaling than for the video media. Do not use

Parameter	Description
	<p>this application type if both the same network policies apply to both video and video signaling traffic.</p> <ul style="list-style-type: none"> ● voice: Select this application type if the AP services IP telephones and other appliances that support interactive voice services. This is the default application type. ● voice-signaling: Select this application type if the AP is part of a network that requires a different policy for voice signaling than for the voice media. Do not use this application type if both the same network policies apply to both voice and voice signaling traffic.
LLDP-MED application VLAN	Specify a VLAN by VLAN ID (0-4094) or VLAN name.
LLDP-MED application VLAN tagging	<p>Click this checkbox if the LLDP-MED policy applies to a to a VLAN that is tagged with a VLAN ID or untagged. The default value is untagged.</p> <p>NOTE: When an LLDP-MED network policy is defined for use with an untagged VLAN, then the L2 priority field is ignored and only the DSCP value is used.</p>
Advanced Settings	
LLDP-MED application Layer-2 priority	Specify a 802.1p priority level for the specified application type, by entering a value from 0-7, where 0 is the lowest priority level and 7 is the highest priority.
LLDP-MED application Differentiated Services Code Point	Select a Differentiated Services Code Point (DSCP) priority value for the specified application type by specifying a value from 0-63, where 0 is the lowest priority level and 63 is the highest priority.

13. Apply to save your settings.

In the CLI

```

ap lldp profile <profile>
  clone <profile>
  dot1-tlvs port-vlan|vlan-name
  dot3-tlvs link-aggregation|mac|mfs|power
  lldp-med-network-policy-profile <profile>
  lldp-med-tlvs capabilities|inventory|network-policy
  no ...
  optional-tlvs capabilities|management-address|port-description|system-description|system-
  name
  receive
  transmit
  transmit-hold <transmit-hold>
  transmit-interval <transmit-interval>
ap lldp med-network-policy-profile <profile>
  application-type guest-voice|guest-voice-signaling|softphone-voice|streaming-video|video-
  conferencing|video-signaling|voice|voice-signaling
  clone <profile>
  dscp <dscp>
  l2-priority <l2-priority>
  no ...
  tagged
  vlan <vlan>

```

The following commands create a LLDP MED network policy profile for streaming video applications and marks streaming video as high-priority traffic.

```

(host) (config) ap lldp med-network-policy-profile vid-stream
(host) (AP LLDP-MED Network Policy Profile "vid-stream") dscp 48
(host) (AP LLDP-MED Network Policy Profile "vid-stream") l2-priority 6

```

```
(host) (AP LLDP-MED Network Policy Profile "vid-stream") tagged
(host) (AP LLDP-MED Network Policy Profile "vid-stream") vlan 10
(host) (AP LLDP-MED Network Policy Profile "vid-stream")!
```

Next, the LLDP MED network policy profile is assigned to an LLDP profile, and the LLDP profile is associated with an AP wired-port profile.

```
(host) (config) ap lldp profile video1
(host) (AP LLDP Profile "video1")lldp-med-network-policy-profile vid-stream
(host) (AP LLDP Profile "video1")!
(host) (config)ap wired-port-profile corp2
(host) (AP wired port profile "corp2")lldp-profile video1
```

Advanced Voice Troubleshooting

ArubaOS enables you to debug voice issues more efficiently and quickly by providing detailed information about the voice calls, voice client status, and Call Detail Records (CDR). You can obtain the advanced troubleshooting information such as time of failure of the call, status of the client during the call failure, signal strength of the call, AP handoff information, and signaling message issues.

The following options allow you to easily troubleshoot voice call issues:

- View troubleshooting information on voice client status
- View troubleshooting information on voice call CDRs
- Debug voice logs
- View voice traces
- View voice configuration details

Viewing Troubleshooting Details on Voice Client Status

ArubaOS enables you to view the status of the voice clients. Additionally, it allows you to view more details such as AP handoff information and AP station report of an active call based on the client's IP address, or the MAC address.

The AP handoff information includes the AP events such as association request, re-association request, and de-authentication request with timestamps. The AP station report includes the AP MAC address, association time, average RSSI value, and retries count.

You can use the WebUI or CLI to view up to 60 entries of AP events and 30 entries of AP station reports for a voice client.

In the WebUI

1. Navigate to the **Monitoring > Voice > Voice Clients** page and select the voice client.
2. Click the **HandOff Information** button to view the AP station report and AP handoff information of the selected voice client.

In the CLI

To view the details of a voice client based on its IP address:

```
(host) #show voice client-status ip 10.15.20.63
```

```
Voice Client(s) Status
```

```
-----
Client (IP)   Client (MAC)      Client Name  ALG   Server (IP)   Registration State  Call
Status  BSSID           ESSID        AP Name  Flags
-----  -
---  ---            ---          ---     ---           ---                ---
```



```

10.15.20.63 00:00:f0:05:c9:e3 7812 h323 10.3.113.239 REGISTERED In-Call
00:0b:86:b7:83:91 st-voice-raj RAP2-Lab R
Num Clients:1
Flags: V - Visitor, W - Wired, R - Remote

```

AP Events

```

-----
Timestamp      BSS Id          Category  Event
-----
Aug 13 09:22:57 00:0b:86:b7:83:91 Call      Call Start
Aug 13 11:29:34 00:0b:86:b7:83:91 Call      Call End
Aug 13 11:29:41 00:0b:86:b7:83:91 Call      Call Start
Aug 13 11:30:29 00:0b:86:b7:83:91 Call      Call End
Aug 13 11:30:39 00:0b:86:b7:83:91 Call      Call Start

```

AP Station Reports

```

-----
Timestamp      BSS Id          RSSI Tx      Tx-Drop Tx-Data Tx-Data-Retry Tx-Data-
Bytes Tx-Data-Time Rx      Rx-Retry
-----
Aug 13 12:35:05 00:0b:86:b7:83:91 61 253845 6904 253469 59805 22945603
0 55171662 0

```

Current Active Calls

```

-----
Session Information      Peer Party Dir Status Dur(sec) Orig time
R-value Codec Band Setup Time(sec) Re-Assoc
-----
10.15.20.56:3034 - 10.15.20.63:3140 - IC CONNECTED 3925 Aug 13 11:30:39
NA NA NA NA 0

```

To view the details of a voice client based on its MAC address:

```
(host) #show voice client-status sta 00:00:f0:05:c9:dc
```

Voice Client(s) Status

```

-----
Client(IP) Client(MAC) Client Name ALG Server(IP) Registration State Call
Status BSSID ESSID AP Name Flags
-----
10.15.20.56 00:00:f0:05:c9:dc 7811 sh323 10.3.113.239 REGISTERED In-Call
00:1a:1e:a8:2d:80 legap W-AP65-2

```

Num Clients:1

Flags: V - Visitor, W - Wired, R - Remote

AP Events

```

-----
Timestamp      BSS Id          Category  Event
-----
Aug 13 09:22:54 00:1a:1e:a8:2d:80 Call      Call Start
Aug 13 09:22:58 00:1a:1e:a8:2d:80 Call      Call End
Aug 13 09:26:22 00:1a:1e:a8:2d:80 Call      Call Start
Aug 13 11:29:33 00:1a:1e:a8:2d:80 Call      Call End
Aug 13 11:29:39 00:1a:1e:a8:2d:80 Call      Call Start
Aug 13 11:30:29 00:1a:1e:a8:2d:80 Call      Call End
Aug 13 11:30:36 00:1a:1e:a8:2d:80 Call      Call Start

```

AP Station Reports

```
-----
Timestamp          BSS Id          RSSI Tx      Tx-Drop Tx-Data Tx-Data-Retry Tx-Data-
Bytes Tx-Data-Time Rx      Rx-Retry
-----
Aug 13 12:38:03 00:1a:1e:a8:2d:80 44 795216 44158 794838 147824 78010395
0 58366710 0
```

Current Active Calls

```
-----
Session Information
R-value Codec Band Setup Time(sec) Peer Party Dir Status Dur(sec) Orig time
-----
10.15.20.63:3140 - 10.15.20.56:3034 - OG CONNECTED 4079 Aug 13 11:30:36
93 NA GREEN NA 0
```

Viewing Troubleshooting Details on Voice Call CDRs

ArubaOS allows you to view the voice CDRs for the completed calls. Additionally, it enables you to view more details such as AP handoff information and AP station reports for a specific terminated call based on the CDR Id.

The AP handoff information includes the AP events such as association request, re-association request, and de-authentication request with timestamps. The AP station report includes the AP MAC address, association time, average RSSI value, and retries count.



NOTE: ArubaOS pushes the generated CDRs to the syslog server to retain the older CDR data for a later analysis. The CDR data pushed to the syslog server do not contain the details of the AP stats and AP events.

You can use the WebUI or CLI to view the troubleshooting information on a voice call based on the CDR Id.

In the WebUI

1. Navigate to the **Monitoring > Voice > Call Detail Report** page.

This page displays the CDRs of the completed calls.

2. Click the **CDR Id** of a call to view the AP station reports, and the AP handoff information of the call.

In the CLI

To view the details of a completed call based on the CDR Id:

```
(host) #show voice call-cdrs cid 4
```

```
Voice Client(s) CDRs (Detail)
-----
```

```
CDR Id Client IP Client Name ALG Dir Called/Calling Party Status Dur(sec) Orig
time R-value Reason Codec Band Setup Time(sec) Re-Assoc Initial-BSSID
Initial-ESSID Initial-AP Name
-----
4 10.15.20.62 3011 sccp IC 3042 SUCC 34 Aug 14
06:48:44 77 G711 YELLOW 0 1 00:1a:1e:a8:2d:80 legap
W-AP65-2
```

AP Events

Timestamp	BSS Id	Category	Event
Aug 14 06:48:53	00:1a:1e:a8:2d:80	AP Management	Assoc Req
Aug 14 06:48:53	00:1a:1e:a8:2d:80	AP Management	Assoc Resp

AP Station Reports

Timestamp	BSS Id	RSSI	Tx	Tx-Drop	Tx-Data	Tx-Data-Retry	Tx-Data-
Bytes	Tx-Data-Time	Rx	Rx-Retry				
Aug 14 06:49:08	00:1a:1e:a8:2d:80	27	20466	6154	20460	2522	2310190
0	26245 0						

Enabling Voice Logs

ArubaOS allows you to debug voice logs. Additionally, it allows you to debug the voice logs for a specific voice client based on the client's MAC address.

You can use the WebUI or CLI to set the voice logging level to debugging.

In the WebUI

1. Navigate to the **Configuration > Management > Logging** page.
2. Click the **Levels** tab.
3. Select the **voice** check box under the **User Logs** category.
4. Select **Debugging** from the **Log Level** drop down menu and click the **Done** button.

Figure 318: Enable Voice Logging

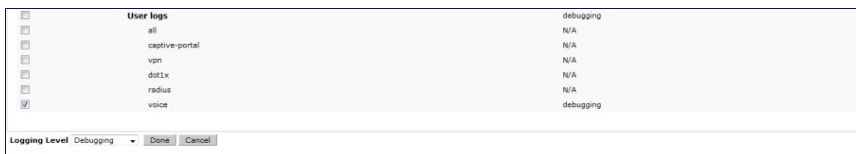

5. Click the **Apply** button to apply the settings and save the configurations.

Enabling Logging for a Specific Client

1. Navigate to the **Configuration > Advanced Services > All Profiles** page.
2. Expand **Other Profiles** under the **Profiles** section and click **VoIP Logging**.
3. Enter the MAC address of the voice client in the **Client's MAC address for logging** field.

Figure 319: Enable Logging for a Voice Client

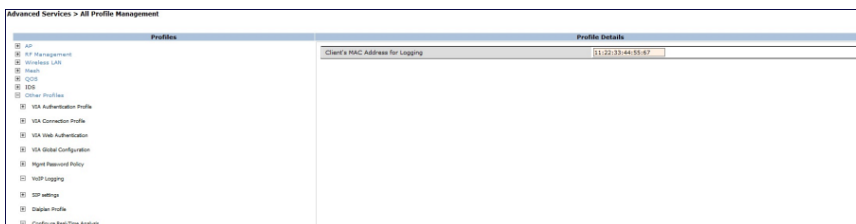

4. Click the **Apply** button to apply the settings and save the configurations.



NOTE: To enable logging on a specific voice client, you must enable voice logs.

In the CLI

To set the voice logging level to debugging:

```
(host) #configure terminal
(config) #logging level debugging user subcat voice
```

To debug voice logs for a specific client:

```
(config) #voice logging
(VoIP Logging) #client-mac 11:22:33:44:55:67
```

To view the client's MAC address for logging:

```
(host) #show voice logging
```

```
VoIP Logging
-----
Parameter                               Value
-----
Client's MAC Address for Logging 11:22:33:44:55:67
```

Viewing Voice Traces

ArubaOS enables you to view the voice signaling message traces. You can view up to 8000 entries of trace messages. The trace message displays the ALG, client name, client's IP, event time, and the message direction. Additionally, it displays the BSSID information to help troubleshooting roaming issues.

You can use the WebUI or CLI to view the trace messages.

In the WebUI

1. Navigate to the **Monitoring > Voice > Voice Clients** page and select the voice client.
2. Click the **Troubleshooting** button to view the voice traces.

In the CLI

To view the voice signaling message traces:

```
(host)#show voice trace sip count 5
```

```
SIP Voice Client(s) Message Trace
-----
ALG  Client Name  Client (MAC)      Client (IP)  Event Time  Direction  Msg
---  -
      BSSID
      -----
SIP  6202          00:03:2a:02:75:cc  10.15.20.123  Aug 14 13:14:32  Server-To-Client  200_OK
      00:0b:86:b7:83:91
SIP  6202          00:03:2a:02:75:cc  10.15.20.123  Aug 14 13:14:32  Client-To-Server
REGISTER 00:0b:86:b7:83:91
SIP  6202          00:03:2a:02:75:cc  10.15.20.123  Aug 14 13:14:31  Server-To-Client  200_OK
      00:0b:86:b7:83:91
SIP  6202          00:03:2a:02:75:cc  10.15.20.123  Aug 14 13:14:31  Client-To-Server
REGISTER 00:0b:86:b7:83:91
SIP  6202          00:03:2a:02:75:cc  10.15.20.123  Aug 14 13:14:29  Server-To-Client  4XX_
REQUEST_FAILURE 00:0b:86:b7:83:91
Num of Rows:5
```

Viewing Voice Configurations

ArubaOS allows you to view the details of the voice related configurations on your controller such as firewall policies, AP group profiles, SSID profiles, virtual AP group profiles, VoIP Call Admission Control profiles, 802.11k profiles, and SIP settings. Additionally, you can view the status of RTCP analysis, and SIP mid-call request timeout.



NOTE: This release of ArubaOS does not support viewing the voice configuration details using the WebUI.

In the CLI

To view the voice configuration details on your controller:

```
(host) #show voice configurations
```

Voice firewall policies

```
-----  
Policy                Action  
-----  
Stateful SIP Processing  Enabled  
Broadcast-filter ARP     Disabled
```

SSID Profiles

```
-----  
Profile Name          WMM      WMM-UAPSD  TSPEC Min Inactivity(msec)  ... EDCA STA prof  
EDCA AP prof  Strict SVP  
-----  
-----  
default          Enabled  Enabled    100000          ... default  
default          Disabled  
qa-ma-vocera     Enabled  Enabled     0                default  
default          Disabled
```

AP Group Profiles

```
-----  
Profile Name  VoIP CAC Profile  
-----  
default      default  
local        default
```

Virtual AP Group Profiles

```
-----  
Profile Name          802.11K Profile  HA Discovery on-assoc.  Drop Broadcast/Multicast  
Broadcast ARP to Unicast  
-----  
-----  
abcd                  default          Disabled                Disabled  
Disabled
```

VoIP Call Admission Control Profiles

```
-----  
Profile Name  VoIP CAC  
-----  
default      Disabled
```

802.11K Profiles

```
-----  
Profile Name  Advertise 802.11K Capability  
-----  
default      Disabled
```

SIP settings

Parameter	Value
-----	-----
Session Timer	Disabled
Session Expiry	300 sec
Dialplan Profile	N/A

Voice rtcp-inactivity:disable

Voice sip-midcall-req-timeout:disable

Chapter 38

Instant AP VPN Support

Dell PowerConnect W-Series ArubaOS 6.2 is the companion controller release for the Dell Instant release. This release provides an ability to terminate VPN and GRE tunnels from Instant AP and provide corporate connectivity to the branch Instant AP network. For details on all the features described in the following sections, see the *Dell PowerConnect W-Series Instant Access Point User Guide*.

VPN features are ideal for:

- enterprises with many branches that do not have a dedicated VPN connection to the Head Quarter.
- branch offices that require multiple APs.
- individuals working from home, connecting to the VPN.

This new architecture and form factor seamlessly adds the survivability feature of Instant APs with the VPN connectivity of RAPs — providing corporate connectivity to branches.

This documentation for this feature includes the following topics:

- ["Overview" on page 727](#)
- ["VPN Configuration" on page 728](#)
- ["Viewing Branch Status" on page 729](#)

Overview

This section provides a brief summary of the new features included in Dell PowerConnect W-Series ArubaOS 6.2 to support VPN termination from Instant AP.

Termination of Instant AP VPN tunnels

Instant AP (IAP) has the ability to terminate VPN tunnels on controllers. The IAP cluster creates a tunnel from the Virtual Controller to a Dell mobility controller in your corporate office. The controller acts a VPN end-point and does not provide the IAP with any configuration. For more information on how to create a VPN tunnel from Virtual Controller to a Dell mobility controller, see the *Dell PowerConnect W-Series Instant Access Point User Guide*.

Termination of IAP GRE tunnels

IAPs have the ability to terminate GRE tunnels on controllers. The IAP cluster creates a tunnel from the Virtual Controller to a Dell mobility controller in your corporate office. The controller acts a GRE end-point and does not provide the Instant AP with any configuration. For more information on how to create a GRE tunnel from Virtual Controller to a Dell mobility controller, see the *Dell PowerConnect W-Series Instant Access Point User Guide*.

L2/L3 network mode support

The Virtual Controller (VC) on an Instant AP enables different DHCP pools (various deployment models) in addition to allocating IP subnets to each branch. The following modes of DHCP server are supported:

- **L2 Switching Mode:** In this mode, Instant supports distributed L2 and centralized L2 switching modes of connection to corporate. When an Instant AP registers with the controller and has a L2 mode DHCP pool configured, the controller automatically adds the GRE or VPN tunnel associated to this IAP into the VLAN multicast table. This allows the clients connecting to this L2 mode VLAN to be part of the same L2 domain on controller.
- **L3 Routing Mode:** In this mode, Instant supports L3 routing mode of connection to corporate. The VC assigns an IP addresses from the configured subnet and forwards traffic to both corporate and non-corporate destinations. Instant AP takes care of routing on the subnet and also adds a route on the controller after the VPN tunnel is set up during the registration of the subnet. When the Instant AP registers with a L3 mode DHCP pool, the controller automatically adds a route to this DHCP subnet enabling routing of traffic from the corporate to clients on this VLAN in the branch.

VPN Configuration

The following VPN configuration steps on the controller, enable IAPs to terminate their VPN connection on the controller:

Whitelist DB Configuration

Controller Whitelist DB

You can use the following CLI command to configure the whitelist DB if the controller is acting as the whitelist entry:

```
(host) #local-userdb-ap add mac-address 00:11:22:33:44:55 ap-group test
```

The **ap-group** parameter is not used for any configuration, but needs to be configured. The parameter can be any valid string. If an external whitelist is being used, the MAC address of the AP needs to be saved in the Radius server as a lower case entry without any delimiter.

External Whitelist DB

The external whitelist functionality enables you to configure the RADIUS server to use an external whitelist for authentication of MAC addresses of RAPs.

If you are using Windows 2003 server, perform the following steps to configure external whitelist on it. There are equivalent steps available for Windows Server 2008 and other RADIUS servers.

1. Add the MAC addresses for all the RAPs in the Active Directory of the Radius server:
 - a. Open the **Active Directory and Computers** window, add a new user and specify the MAC address (without the colon delimiter) of the RAP for the user name and password.
 - b. Right-click the user that you have just created and click **Properties**.
 - c. In the **Dial-in** tab, select **Allow access** in the **Remote Access Permission** section and click **OK**.
 - d. Repeat Step a through Step b for all RAPs.
2. Define the remote access policy in the Internet Authentication Service:
 - a. In the **Internet Authentication Service** window, select **Remote Access Policies**.
 - b. Launch the wizard to configure a new remote access policy.
 - c. Define filters and select **grant remote access permission** in the **Permissions** window.
 - d. Right-click the policy that you have just created and select **Properties**.
 - e. In the **Settings** tab, select the policy condition, and **Edit Profile...**
 - f. In the **Advanced** tab, select **Vendor Specific**, and click **Add** to add new vendor specific attributes.
 - g. Add new vendor specific attributes and click **OK**.

- h. In the **IP** tab, provide the IP address of the RAP and click **OK**.

VPN Local Pool Configuration

The VPN local pool is used to assign an IP Address to the IAP after successful XAUTH VPN.

```
(host) # ip local pool "rapngpool" <startip> <endip>
```

VPN Profile Configuration

The VPN profile configuration defines the server used to authenticate the IAP (internal or an external server) and the role for IAP user. This role is used to define src-nat rule to Radius server to get Dynamic Radius proxy working.

```
(host) (config) #ip access-list session iaprole
(host) (config-sess-iaprole)#any host <radius-server-ip> any src-nat
(host) (config-sess-iaprole)#any any any permit
(host) (config-sess-iaprole)#!
(host) (config) #user-role iaprole
(host) (config-role) #session-acl iaprole
(host) (config-role) #!
(host) (config) #aaa authentication vpn default-iap
(host) (VPN Authentication Profile "default-iap") #server-group default
(host) (VPN Authentication Profile "default-iap") #default-role iaprole
```

For more information on VPN profile configuration, see the *Dell PowerConnect W-Series Instant Access Point Guide*.

Radius proxy for VPN connected IAPs

The Radius proxy for VPN connected IAPs functionality defines the server used to authenticate the IAP (internal or an external server) and the role for IAP user. This role is used to define src-nat rule to Radius server to get Dynamic Radius proxy working.

```
(host) (config) #ip access-list session iaprole
(host) (config-sess-iaprole)#any host <radius-server-ip> any src-nat
(host) (config-sess-iaprole)#any any any permit
(host) (config-sess-iaprole)#!
(host) (config) #user-role iaprole
(host) (config-role) #session-acl iaprole
(host) (config-role) #!
(host) (config) #aaa authentication vpn default-iap
(host) (VPN Authentication Profile "default-iap") #server-group default
(host) (VPN Authentication Profile "default-iap") #default-role iaprole
```

For more information on configuration of RADIUS proxy for VPN connected IAPs, see the *Dell PowerConnect W-Series Instant Access Point User Guide*.

Viewing Branch Status

To view the details of the branch information connected to the controller, issue the **show iap table** command.

Example

This example shows the details of the branches connected to the controller:

```
(host) (config) #show iap table
```

Branch Key	Index	Status	Inner IP	MAC Address
d8f6095a01f89b7aea4340c080c3e3c8bd062758461c32c92-d	8	DOWN	0.0.0.0	d8:c7:c8:c0:01:6-c

4619fa8b014ff058d99e9fe63286c19851e61466627d05496-8	16	DOWN	0.0.0.0	00:1a:1e:08:21:e-1
0e26e65a01732247f98b5d463f1fb56c0200d0944fab521e5-7	3	DOWN	0.0.0.0	d8:c7:c8:c0:01:6-c
cc0b838d014df7db3eb453ef4f513204df4d74bb4063e4658-7	7	DOWN	0.0.0.0	d8:c7:c8:c0:b8:d-0
6bccde5901997e534d14b10580371792ef4c13ca868c92915-0	15	DOWN	0.0.0.0	d8:c7:c8:c0:01:6-c
764f6038018f2c2765292911e55fedc0c98f86cf79331d890-5	6	UP	10.15.207.20-6	00:24:6c:c9:27:c-f
c2b46b530119844dcbdb55ddb94ff308d1f08ec7cb4eda113-c	0	DOWN	0.0.0.0	d8:c7:c8:c0:b8:d-6
9deb828c0106f4562b50c8141cfa28ad5c1a3f89b3e171efc-c	14	DOWN	0.0.0.0	00:1a:1e:08:23:f-4
be5ffcf801eedd92a76b978ceee53f4e2284c8e8f3dbd8445-7	5	DOWN	0.0.0.0	00:24:6c:c9:27:c-f
b5d279460166c39a5fb9462a65559eb91266b9ac9f8e2356a-0	13	DOWN	0.0.0.0	d8:c7:c8:c0:01:6-c
0f7057990174cde7901a0c8779baeb7393b26d974a45eb860-2	10	DOWN	0.0.0.0	00:24:6c:c0:41:f-2
a1e23c1201cfb76a50fb3328e58c9825e716a259dd71874c6-7	4	UP	10.15.207.20-7	00:24:6c:c9:18:6-4
47f930fc019317069d04fd1c2ffdf6a49a6e51c148c2164ed-0	9	DOWN	0.0.0.0	d8:c7:c8:c0:01:6-c
0c478ce101df81e3c0a46fe4f3ab6eca9bb012151dea99a82-f	1	DOWN	0.0.0.0	d8:c7:c8:c0:01:6-c
747c20ac0155736c3b11bd972c967ebdf7c9883e69ec2a01f-b	2	DOWN	0.0.0.0	d8:c7:c8:c0:b8:d-0
0e40138601b34eb33fb57d94208848b0f8e37bba0a6a0d43c-a	12	DOWN	0.0.0.0	00:24:6c:c9:18:6-4
de293919019196d7c8ac8f04a50fbd5b96c2af3d3576aa1dc-2	11	DOWN	0.0.0.0	d8:c7:c8:c0:b8:d-8
208c416e01e1cfaf0fdc11190349ad43334879f39ba9e1918-8	17	DOWN	0.0.0.0	d8:c7:c8:c0:01:6-c

The output of this command includes the following parameters:

Table 320: IAP Table Parameters

Parameter	Description
Branch Key	Key for the branch, which is unique to each branch.
Index	Index assigned to the branch.
Status	Current status of the branch (UP/DOWN).
Inner IP	Internal VPN IP of the branch.
MAC Address	MAC address of the Virtual Controller of the branch.

Chapter 39

W-600 Series Controllers

The W-600 Series Controller is designed for compact, cost-effective "all-in-one" networking solutions. The 600 Series includes a firewall, wireless LAN controller, Ethernet switch with PoE+, IP router, site-to-site VPN edge device, file server, and print server.

The W-600 Series is an enterprise-class, wireless LAN controller that connects, controls, and integrates wireless APs and Air Monitors (AMs) into a wired LAN system. [Table 321](#) list some of the hardware features by the numbers.

Table 321: 600 Series Controller by the Numbers

Controller	USB Ports	Maximum External APs	Remote APs
W-620	1	8	8
W-650	4	16	16

Topics in this chapter include:

- ["Understanding W-600 Series Best Practices and Exceptions" on page 731](#)
- ["Connecting with a USB Cellular Modems" on page 732](#)
- ["Configuring a Supported USB Modem" on page 735](#)
- ["Configuring a New USB Modem" on page 736](#)
- ["Setting Up NAS \(Network-Attached Storage\) Devices" on page 739](#)
- ["Connecting to a Print Server" on page 742](#)
- ["W-600 Series Sample Topology and Configuration" on page 743](#)
- ["W-600 Series Sample Topology and Configuration" on page 743](#)

Understanding W-600 Series Best Practices and Exceptions

- Only FAT16, FAT32, ext2 and ext3 partitions are supported.
- For shared folders in an ext2/ext3 partition, the owner of the folder must be "nobody". Otherwise clients will not be able to access the shared folder.
- Unsupported partitions may exist on the NAS device; only supported partitions are mounted.
- User authentication for file access is not supported. The same permissions are applicable to all users.
- Sharing disks that contain errors may cause unpredictable behavior. Scan the disk for errors before mounting the disks to a W-600 Series.
- Un-mount all partitions before disconnecting the disk from the controller.
- Detection of devices connected to an external USB hub may be unpredictable.
- A USB hard disk connected to the controller via an USB ExpressCard adapter is not supported.

Connecting with a USB Cellular Modems

USB Cellular Modems are supported via a USB port. ArubaOS supports several EVDO (Evolution Data Optimized, up to 3.1 Mbps, CDMA) and 3G HSPA (High-Speed Packet Access, 3G data service) modems. The 3G HSPA is provided by AT&T in the United States and numerous other 3G providers worldwide.

How it Works

Plug the USB Cellular Modem into the USB port of the W-600 Series controller. The USB Cellular Modem is automatically detected and negotiates a PPP IP address. If the modem fails to obtain a PPP IP address within 45 seconds, the controller ignores the modem's presence, and boots as if the modem is not present.

Switching Modes

Many of the newer modems contain multiple USB devices; creating a very elegant plug-n-play solution. When your USB Cellular Modem is first powered on, a storage device is registered. This storage device contains the software driver/executable necessary to install and operate the modem.

Once the software installation is complete, the modem must *mode-switch* from a storage device to a registered modem device. Mode-switching varies by manufacturer. For example, The Novatel modem mode-switches via a SCSI eject command; the Huawei modem mode-switches via a SCSI rezero command, while the Sierra modem mode-switches via a specific USB command. Once the mode-switching is complete, the modem automatically registers itself.

The controller can dial (via the modem) your Service Provider to initiate a PPP session. During the boot sequence, the controller issues your device's mode-switching command, every few seconds, until the PPP link connects.

Finding USB Modem Commands

To support the USB cellular modems on the W-600 Series cellular specific commands are available at the command line (see [Figure 322](#) and [Figure 323](#)). For detailed information on these commands, refer to the Command Line Reference Guide.

Figure 322: Cellular Profile Commands

```
(host) (config) # cellular profile profile_name
(host) (config-cellular profile_name) # ?
dialer          Dialer group settings
driver          Cellular modem driver
import          Import USB device parameters
modeswitch      USB device modeswitch settings
no              Delete Command
priority        Override default priority
serial          USB device serial
tty             Modem TTY port
user            User name authentication
```

[Figure 323](#) list the Uplink commands.

Figure 323: Uplink Commands

```
(host) (config) # uplink ?
cellular        Cellular uplink configuration
disable         Disable uplink manager
enable          Enable uplink manager
wired           Wired uplink configuration
```

You can view connected USB cellular devices via the **Controller > Universal Serial Bus > USB Devices** in the Web UI (see [Figure 324](#)). Navigating to this page is the equivalent of executing the `show usb` command at the command prompt.

Figure 324: Connected Cellular Devices

Address	Product	Vendor	ProdID	Serial	Type	Profile	Stat
3	Flash Voyager	1b1c	0ab1	a3c60203be7320	Storage		

Uplink Manager

Access the Uplink Manager feature from the WebUI Configuration tab. Navigate to this feature via **Uplink > Uplink Manager** ([Figure 325](#)).

Figure 325: WebUI Uplink Manager

Id	Uplink Type	Properties	Priority	State	Status
1	Wired	vlan 1	200	Connected	* Active *

You can enable/disable the uplink to overwrite cellular and wired uplink priority. The corresponding commands are:

```
(host) (config)# uplink [enable | disable]
(host) (config)# uplink [cellular | wired] priority [x]
```

Cellular Profile

The Cellular Profile tab allows you to add/modify/delete one or more cellular profiles. The WebUI screen for Cellular Profile is divided into the Cellular Profile Table (the top portion) and the Modify Cellular Profile (the bottom portion). When a cellular profile is selected for modification (see [Figure 326](#)) the bottom modify portion is revealed. All changes are entered into the buffer until the Apply button is executed.

Figure 326: Cellular Profile from the WebUI

The screenshot shows the 'Cellular Profile' configuration page in the WebUI. The left sidebar contains navigation options like 'Wizards', 'Network', 'Uplink', 'Security', 'Wireless', and 'Management'. The main content area is titled 'Network > Uplink > Cellular Profile' and includes a 'Uplink Manager' tab. Below the tabs is a 'Cellular Profile Table' with columns for Name, Vend, Prod, Serial, Dialer, Tty, Driver, Priority, Modeswitch, and Actions. The table lists several profiles, including Novatel_U720, Novatel_U727, Kyocera_KPC680, Sierra_Compass_597, Pantech_UM175, Sierra_USBCConn_881, USBCConn_Mercury_CB85, and Globetrotter_Icon322. Below the table is a 'Modify Cellular Profile' form with fields for Cellular Profile Name, USB Vendor ID, USB Product ID, USB Serial No., Dialer Group Setting, Cellular Modem Driver, Modeswitch Parameter, User Name Authentication, and Password Authentication. The 'Commands' section at the bottom shows 'View Commands'.

Dialer Group

Use the Dialer Group command to configure EVDO devices that require specific input for the initial string (init-string) and dial string. When adding or modifying an existing dialer group (see [Figure 327](#)), the WebUI executes the following commands:

```
(host) (config-cellular profile_name)# dialer group <name> init-string <string>
(host) (config-cellular profile_name)# dialer group <name> dial-string <string>
```

Figure 327: Configuring Dialer Group

The screenshot shows the 'Dialer Group' configuration page in the WebUI. The left sidebar is the same as in Figure 326. The main content area is titled 'Network > Uplink > Dialer Group' and includes a 'Uplink Manager' tab. Below the tabs is a 'Dialer Group Table' with columns for Name, Init String, Dial String, and Actions. The table lists two dialer groups: evdo_us and gsm_us. Below the table is a 'Modify Dialer Group' form with fields for Name, Init String, and Dial String. The 'Commands' section at the bottom shows 'View Commands'.

Configuring a Supported USB Modem

If your USB Modem is a validated modem, then no configuration is needed. Just follow the “plug and play” steps below.

1. Insert the USB Modem into an open USB port.
2. Verify that the modem is detected (**show usb** command)

Figure 328: Display supported USB modems

```
(host) #show usb
Address Product          Vendor ProdID  Serial          Type  Profile
State
-----
3      Novatel Wireless CDMA 1410   4100   091087843891000 Cellular Novatel_U727
Device ready
```

If your modem is not recognized (such as “type is unknown”, “no matching profile”, or “device not ready”), use the **show usb verbose** command to verify your modem is listed.

Figure 329: show usb verbose example (partial)

```
((host) #show usb verbose
...
T: Bus=01 Lev=02 Prnt=02 Port=00 Cnt=01 Dev#= 3 Spd=12 MxCh= 0
D: Ver= 1.10 Cls=00(>ifc ) Sub=00 Prot=00 MxPS=64 #Cfgs= 1
P: Vendor=1410 ProdID=4100 Rev= 0.00
S: Manufacturer=Novatel Wireless Inc.
S: Product=Novatel Wireless CDMA
S: SerialNumber=091087843891000
C:* #Ifs= 5 Cfg#= 1 Atr=a0 MxPwr=500mA
```

3. Verify the modem is registered with the Uplink Manager.

Figure 330: show uplink

```
(host) #show uplink
Id Uplink Type Properties Priority State Status
-----
1 Wired vlan 1 200 Connected * Active *
2 Cellular Novatel_U727 100 Standby Ready
```

Cellular uplinks have a lower priority than wired links by default. You can change the default by changing the profile-specific priority or by changing the default cell priority.

Figure 331: uplink cellular priority

```
(host) (config) #uplink cellular priority 201
(host) (config) #
```

4. Check the modem dialing status. The connection may take up to a 45 seconds to establish. To see the connection progress, execute the **show uplink connectionuplink id** command.
5. Verify the connection is established and IP addressed is programmed.
 - Once the cellular link state is *Connected*, you can find the PPP dynamic entries by executing the command **show uplink connection id**
 - The IP address can be found using the command **show ip interface brief**
 - The Gateway can be found using the command **show ip route**

- The DNS entries can be found using the command `show ip domain-name`

Configuring a New USB Modem

Cellular modems must be activated before they can “talk” on the cellular network. Typically, the activation is done by the carrier. Some carriers use a proprietary PC client. In all cases, make sure that your modem works on your PC before using it on the W-600 Series.



NOTE: Verify your modem is activated and works with your Microsoft Windows or Apple Mac computers.

Each time a USB device is inserted, Linux assigns it a new USB address. This is true even if the same device is re-inserted. Modem ports are organized under their individual addresses. For example, `ttyUSB0` at address 3 is separate than `ttyUSB0` at address 7. The address is displayed when you execute the commands, `show usb` and `show usb verbose` (the `Dev#` field).

Configuring the Profile and Modem Driver

1. Insert the USB Modem into an open USB port.
2. Verify that the modem is detected (the `show usb` command. (see [Figure 339](#).)
3. If your modem is not recognized (such as “type is unknown”, “no matching profile”, or “device not ready”), use the `show usb verbose` (see [Figure 333](#)) command to verify your modem is listed.
4. Create a cellular profile and import the identifiers. The Dialer, TTY, and Driver fields are the new profile defaults.

Figure 332: *cellular profile new_card command*

```
(host) (config) #cellular profile new_card
(host) (config-cellular new_card)# import 10
(host) (config-cellular new_card)# show cellular profile

Cellular Profile Table
-----
Name          Vend  Prod  Serial          Dialer  Tty    Driver  Priority
Modeswitch
-----
```

5. Configure the modem driver.

The default “option” driver is a catch-all for cellular modems. Nearly all cards use this driver and support for new modems are added here. Once option driver is configured to work with this device, it recognizes the modem and expose its ports. The following example has four serial TTY ports (`option` driver) and one flash device (`usb-storage` driver).

Figure 333: *Driver options*

```
host) #show usb verbose
...
P: Vendor=1410 ProdID=4100 Rev= 0.00
S: Manufacturer=Novatel Wireless Inc.
S: Product=Novatel Wireless CDMA
S: SerialNumber=091087843891000
C:* #Ifs= 5 Cfg#= 1 Atr=a0 MxPwr=500mA
I: If#= 0 Alt= 0 #EPs= 3 Cls=ff(vend.) Sub=ff Prot=ff Driver=option
I: If#= 1 Alt= 0 #EPs= 2 Cls=ff(vend.) Sub=ff Prot=ff Driver=option
I: If#= 2 Alt= 0 #EPs= 2 Cls=ff(vend.) Sub=ff Prot=ff Driver=option
```

If you get entries similar to the example below:

Figure 334: *Driver=(none)*

```
(host) #show usb verbose
...
I: If#= 0 Alt= 0 #EPs= 3 Cls=ff(vend.) Sub=ff Prot=ff Driver=(none)
I: If#= 1 Alt= 0 #EPs= 2 Cls=ff(vend.) Sub=ff Prot=ff Driver=(none)
```

This means the driver does not work with these ports. Try the other drivers and see if they pick up the device. Airprime is the reliable *catch-all* driver, Sierra is for certain Sierra cards, and cdc-acm is a legacy abstract control modem driver. Your goal is to assign a driver for the unclaimed (none) interfaces (If#).

If no option driver appears or only storage interfaces appear, then the modem must be switched to data mode (see "[Switching Modes](#)" on page 732).

Configuring the TTY Port

1. View the exposed TTY ports by executing the `show usb ports 13` command.

Figure 335: *show usb ports 13 command*

```
(host) (config-cellular new_card)# show usb ports 13
ttyUSB0
ttyUSB1
ttyUSB2
ttyUSB3
```

In the example above, the command reveals four exposed TTY ports. One is the modem port, while the other ports are for GPS, real-time statistics, or diagnostics. If the command does not reveal any ports or if only storage devices (such as 'sr0') appear, then the device must be switched to data mode before proceeding. See "[Switching Modes](#)" on page 732 for instruction.

2. Send a test AT command to determine the correct modem port.

Figure 336: *show usb test command*

```
(host) (support)#show usb test 16 ttyUSB0
AT
OK
TTY port responded to modem AT commands
```

In the example above, the TTY port responds with an 'OK'. This indicates that ttyUSB0 is a valid modem port.

There may be more than one modem port; you can continue to send AT commands to determine which ports are modem ports. If the port is not a valid modem port, a time out error is generated as shown in the example below

Figure 337: *Time out error example.*

```
(host) (support)#show usb test 16 ttyUSB1
Error: Timed out while waiting for modem to respond to AT commands
(host) (support)#
```

In the example below, the TTY port does not exist, or is busy with a previous PPP session.

Figure 338: Port I/O error

```
(host) (support)#show usb test 16 ttyUSB4
Error: Port I/O error. TTY port usb/16/ttyUSB4 inaccessible
(host) (support)#
```

Once you find one (or more) modem TTY port, configure it in the cellular profile and test the port.

Testing the TTY Port

After your TTY port is correctly configured, the port is in the 'Device Ready' state.

Figure 339: Device Ready State

```
(host) (config-cellular new_modem)# show usb
USB Device Table
-----
Address  Product                Vendor  ProdID  Serial                Type      Profile  State
-----  -
18       Novatel Wireless CDMA  1410   4100   091087843891000     Cellular  new_modem  Deviceready
(host) (config-cellular new_modem)#
```

The 'Device Ready' state indicates the port has passed the diagnostic test and is ready.

You can also run extended diagnostics to display more information about the modem.



NOTE: Not all modems support the extended AT command set. If the modem hangs after sending an extended AT command; removing the device and then re-inserting it usually fixes the problem

The AT+CSQ command queries the modem's current signal strength. The first number represents the signal ranging from 1 (poor) to 33 (excellent). In the example below, the strength is in the excellent range (31).

Figure 340: usb test extended.

```
(host) #show usb test 18 ttyUSB0 extended
OK
ATIO
Manufacturer: NOVATEL WIRELESS INCORPORATED
Model: U727 SPRINT
Revision: m6800B-RAPTOR65_S-114 [Dec 07 2007 18:00:00]
ESN: 0x5B860A05
+GCAP: +CIS707-A, CIS-856-A, +MS, +ES, +DS
OK
AT+CSQ
31, 99
```

Selecting the Dialer Profile

The phone number, user name, and password (if any) are set in the dialer setting. In the United States, AT&T and T-Mobile use the 'gsm_us' profile, while Sprint and Verizon use the 'evdo_us' profile. User names and passwords are not typically used by U.S. carriers, but they may be required by International carriers.

Choose the dialer group that matches your carrier. If one doesn't exist, create a new dialer group with information from your carrier ([Figure 341](#))

Figure 341: *show dialer group example*

```
(host)# show dialer group
Dialer Group Table
-----
Name          Init String          Dial String
-----
evdo_us       ATQ0V1E0             ATDT#777
gsm_us        AT+CGDCONT=1,"IP","ISP.CINGULAR" ATD*99#
```

The ATD, in the Dial String column in [Figure 341](#), specifies the number to dial, and is typically the same among respective CDMA/GSM carriers. The information under the Init String column typically just resets the modem to the factory default state, but may contain carrier specific options. You can often find these settings in online forums or from your ISP.

Linux Support

The Internet is a great place to research Linux support for your modem. Chances are someone already got it working on their system and their configuration can be leveraged. The following sites provide useful information:

- <http://www.evdoforums.com/>
- <http://ubuntuforums.org>
- <http://www.linux.com/forums>
- <http://kenkinder.com/>

Setting Up NAS (Network-Attached Storage) Devices

The W-600 Series controller allows you to connect a pre-formatted NAS device that can be made available to all connected clients. The W-600 Series supports NAS devices with partitions in filesystem formats:

- ext2
- ext3
- FAT16
- FAT32

The W-600 Series supports a maximum of four devices. To ensure higher reliability, only connect one USB powered device. The other three devices should use an external power source.

NAS Device Setup

Setting up a NAS device involves the following step:

- Connecting the physical device to the USB port in the controller
- Mounting the device on the controller
- Creating a share—To use the mounted NAS device, you must create a share on the NAS device.
- Associating the share with a filesystem path

Power on the NAS device after you connect the NAS device to the W-600 Series controller's USB port. Verify that the usb disk is detected (show usb command).

```
(host) #show usb
```

```
USB Device Table
```

```
-----
```

Address	Product	Vendor	ProdID	Serial	Type	Profile	State
5	OneTouch	0d49	7350	2HAS49ZZ	Storage		
3		0424	2502		Hub		
4	HP LaserJet P3005	03f0	7317	CNH1D00105	Printer		

Configuring in the CLI

1. Login as admin and switch to config mode.
2. Enter the command below to enable NAS service:
(host) (config) #**service network-storage**
3. Enter the **show usb-storage** command to view a list of mounted and unmounted devices:
4. Enter the **show usb-storage partitions** command to view disk partitions:
5. Enter the command below to create a share:
(host) (config)# network-storage share <sharename>
6. Associating the share to a filesystem path—To access the share, you must create a filesystem path to the share. enter:
(host) (config-network-storage share)# share usb: disk <disk name> <filesystem path> mode
Where,
disk name is the name of the disk. You can also specify the disk alias instead of the disk name.
filesystem path is the path to access the share. This path contains the partition name and the shared folder name.
mode is the permission settings. You can either specify read-only or read-write modes.
Example: share usb: disk WD250GB WdImages/desktop mode Read-Write
7. Display the status of a connected NAS device, enter the command:
(host) (config)# show network-storage status

Users can now access the connected storage device from the filesystem path.

For example: \\<controller-ip><sharename><directory> \

Managing NAS Devices

The following commands are available for managing a NAS devices after they are mounted and configured in the controller. For more details on these command, see the *Dell PowerConnect W-Series ArubaOS 6.2 Command Line Interface Reference Guide*.

- Creating an alias for a disk
usb-storage disk WD-2500BEV_External-WD-WXE508ET3777 alias WD250GB
- View list of shares in a disk
show network-storage shares
Displays the disk name, partition name, folder and share name, share path, permission settings and status.
- View list of files opened by clients
show network-storage files opened
Displays the client machine IP address, path to opened file in controller, permission settings and time-stamp details.
- View list of connected users
show network-storage users

- Displays the list of users by IP address, connected share name and connection time.
- View list of directories in a disk

```
show dir usb: disk <disk-name> <filesystem-path>
```

 Displays the list of directories in the specified disk and the filesystem path.
- View mounted and unmounted storage device status

```
show usb-storage
```

 Displays device name, device alias (if any), number of partitions in the device, size and mounted partition status of all disks connected to the controller.
- View mounted storage device status (see

```
show usb-storage mounted
```
- View unmounted storage device status

```
show usb-storage unmounted
```

 Displays if the partitions in the connected disks are unmounted.
- View details of both mounted and unmounted disk partitions

```
show usb-storage partitions
```
- View details of unmounted disk partitions

```
show usb-storage unmounted partitions
```
- View details of mounted disk partitions

```
show usb-storage mounted partitions
```

Mounting and Unmounting Devices

Users who don't have access to the CLI can unmount/mount all the disks using the media eject button. This multi-function button means that pressing and holding the button for shorter or longer periods of time will result in entirely different functions. [Table 342](#) list the functions and related status LED for the multi-function eject button.

Table 342: Multi-function Media Eject Button

Initial State	LED State	Action	Status LED	Function	LED Action Completed
NAS Media Operational	Green-solid	Press and hold media eject button for 1 to 5 seconds only	Amber-flashing	Un-mount all NAS media	Amber-solid
NAS Media Unmounted	Amber-solid	Press and hold media eject button for 1 to 5 seconds only	Amber-flashing	Mount all attached NAS devices, and return to fully functional operation	Green-solid
Operational	Green-solid	Press and hold media eject button for more than 5 seconds only	Red-flashing	Controller goes into Standby	Red-solid
Operating with NAS Media unmounted	Amber-solid	Press and hold media eject button for more than 5 seconds only	Red-flashing	Controller goes into Standby	Red-solid
Standby	Red-solid	Press media eject button	Amber-flashing	Controller wake-up	Green-solid

Connecting to a Print Server

The W-600 Series Controller allows you to connect a printer so that it is available to all connected clients.

Printer Setup Using the CLI

Connect the printer to the controller's USB port and power on the printer. Then you can configure the printer using the CLI.

1. Login to the W-600 Series controller as an admin and switch to config mode.
2. Enable the printer service by entering the command:

```
(host) (config) # service print-server
```
3. To view a list of printers mounted on the controller, type:

```
(host) # show network-printer status
```
4. You can create a printer alias name so that it is identified easily in the network. To create an alias, switch to *config mode* and enter the command:

```
(host) # usb-printer <printer-name> alias <new-printer-name>
```
5. Defining client association
 - a. Maximum clients—You can define the maximum number of clients that can use the printer. Enter the command:

```
(host) (config) # network-printer max-clients <2-20>
```

Currently, the W-600 Series supports a maximum of 20 concurrent clients.

Maximum number of clients per host—To define the maximum number of concurrent clients for a single host, enter the command:

```
(host) (config) # network-printer max-clients-per-host <1-20>
```

The W-600 Series supports a maximum of 20 concurrent clients.
6. Defining printer job storage—To view the maximum number of jobs that can be saved in the memory, type:

```
(host) (config) # network-printer max-jobs <1-50>
```

The 600 Series controller will support a storage of 50 jobs.

You can now access the printer from their clients.

For example: `\\<controller-ip>\<printername>`

Additional Commands for Managing Printers

The following commands are available for managing a printer after they are configured in the controller.

- View printer configuration

```
show network-printer config
```

Displays configuration parameter and its assigned value.
- View list of jobs in printer memory

```
show network-printer job <printer-name>
```
- Delete print jobs

```
network-printer delete <printer-name> job <job-id>
```
- View printer status. The command below displays the printer name, alias, status and status comment.

```
show network-printer status
```

W-600 Series Sample Topology and Configuration

Uses two W-650 Dell controllers to illustrate this example topology. Where a W-650 is used, a W-620 could be used just as effectively.

Remote Branch 1—W-650 Controller

```
masterip 192.168.68.217 ipsec ***** uplink
controller-ip vlan 30
vlan 16
vlan 30
vlan 31
vlan 32
interface gigabitethernet 1/0
    description "GE1/0"
    trusted
    switchport access vlan 16
!
interface gigabitethernet 1/1
    description "GE1/1"
    trusted
    switchport access vlan 30
!
interface gigabitethernet 1/2
    description "GE1/2"
    trusted
    switchport access vlan 31
!
interface gigabitethernet 1/3
    description "GE1/3"
    trusted
    switchport access vlan 32
!
interface vlan 16
    ip address 192.168.16.251 255.255.255.0
!
interface vlan 30
    ip address 192.168.30.1 255.255.255.0
!
interface vlan 31
    ip address 192.168.31.1 255.255.255.0
!
interface vlan 32
    ip address 192.168.32.1 255.255.255.0
!
uplink wired priority 202
uplink cellular priority 201
uplink wired vlan 16
interface tunnel 2003
    description "Tunnel Interface"
    ip address 2.0.0.3 255.0.0.0
    tunnel source 192.168.30.1
    tunnel destination 192.168.68.217
    trusted
    ip ospf area 10.10.10.10
!
ip default-gateway 192.168.16.254
ip route 192.168.0.0 255.255.0.0 null 0
!
router ospf
```

```
router ospf router-id 192.168.30.1
router ospf area 10.10.10.10 stub
router ospf redistribute vlan 30-32
```

Remote Branch 2—W-650 Controller

```
masterip 192.168.68.217 ipsec ***** uplink
controller-ip vlan 50
!
vlan 20
vlan 50
vlan 51
vlan 52
!
interface gigabitethernet 1/0
    description "GE1/0"
    trusted
    switchport access vlan 20
!
interface gigabitethernet 1/1
    description "GE1/1"
    trusted
    switchport access vlan 50
!
interface gigabitethernet 1/2
    description "GE1/2"
    trusted
    switchport access vlan 51
!
interface gigabitethernet 1/3
    description "GE1/3"
    trusted
    switchport access vlan 52
!
interface vlan 20
    ip address 192.168.20.1 255.255.255.0
!
interface vlan 50
    ip address 192.168.50.1 255.255.255.0
!
interface vlan 51
    ip address 192.168.51.1 255.255.255.0
!
interface vlan 52
    ip address 192.168.52.1 255.255.255.0
!
uplink wired priority 206
uplink cellular priority 205
uplink wired vlan 20
interface tunnel 2005
    description "Tunnel Interface"
    ip address 2.0.0.5 255.0.0.0
    tunnel source 192.168.50.1
    tunnel destination 192.168.68.217
    trusted
    ip ospf area 10.10.10.10
!
ip default-gateway 192.168.20.254
ip route 192.168.0.0 255.255.0.0 null 0
!
router ospf
```



```
router ospf router-id 192.168.50.1
router ospf area 10.10.10.10 stub
router ospf redistribute vlan 50-52
```

W-3200 Central Office Controller—Active

```
localip 0.0.0.0 ipsec db947e8dlb383813a4070ab0799fa6246b80fc5cfcc3268f
controller-ip vlan 225
vlan 68
vlan 100
vlan 225
!
interface gigabitethernet 1/0
    description "GE1/0"
    trusted
    switchport access vlan 225
!
interface gigabitethernet 1/1
    description "GE1/1"
    trusted
    switchport access vlan 100
!
interface gigabitethernet 1/2
    description "GE1/2"
    trusted
    switchport access vlan 68
!
interface vlan 68
    ip address 192.168.68.220 255.255.255.0
!
interface vlan 100
    ip address 192.168.100.1 255.255.255.0
!
interface vlan 225
    ip address 192.168.225.2 255.255.255.0
!
interface tunnel 2003
    description "Tunnel Interface"
    ip address 2.1.0.3 255.0.0.0
    tunnel source 192.168.225.2
    tunnel destination 192.168.30.1
    trusted
    ip ospf area 10.10.10.10
!
interface tunnel 2005
    description "Tunnel Interface"
    ip address 2.1.0.5 255.0.0.0
    tunnel source 192.168.225.2
    tunnel destination 192.168.50.1
    trusted
    ip ospf area 10.10.10.10
!
master-redundancy
    master-rrrp 2
    peer-ip-address 192.168.68.221 ipsec password123
!
rrrp 1
    priority 120
    authentication password123
    ip address 192.168.68.217
```

```

vlan 68
preempt
tracking vlan 68 sub 40
tracking vlan 100 sub 40
tracking vlan 225 sub 40
no shutdown
!
vrrp 2
priority 120
ip address 192.168.225.9
vlan 225
preempt
tracking vlan 68 sub 40
tracking vlan 100 sub 40
tracking vlan 225 sub 40
no shutdown
!
ip default-gateway 192.168.68.1
ip route 192.168.0.0 255.255.0.0 null 0
!
router ospf
router ospf router-id 192.168.225.1
router ospf area 10.10.10.10 stub
router ospf redistribute vlan 100,225
!

```

W-3200 Central Office Controller—Backup

```

localip 0.0.0.0 ipsec db947e8d1b383813a4070ab0799fa6246b80fc5cfcc3268f
controller-ip vlan 225
!
interface gigabitethernet 1/0
description "GE1/0"
trusted
switchport access vlan 225
!
interface gigabitethernet 1/1
description "GE1/1"
trusted
switchport access vlan 100
!
interface gigabitethernet 1/2
description "GE1/2"
trusted
switchport access vlan 68
!
interface vlan 68
ip address 192.168.68.221 255.255.255.224
!
interface vlan 100
ip address 192.168.100.5 255.255.255.0
!
interface vlan 225
ip address 192.168.225.1 255.255.255.0
!
interface tunnel 2003
description "Tunnel Interface"
ip address 2.1.0.3 255.0.0.0
tunnel source 192.168.225.1
tunnel destination 192.168.30.1

```

```

        trusted
        ip ospf area 10.10.10.10
!
interface tunnel 2005
    description "Tunnel Interface"
    ip address 2.1.0.5 255.0.0.0
    tunnel source 192.168.225.1
    tunnel destination 192.168.50.1
    trusted
    ip ospf area 10.10.10.10
!
master-redundancy
    master-vrrp 2
    peer-ip-address 192.168.68.220 ipsec password123
!
vrrp 1
    priority 99
    authentication password123
    ip address 192.168.68.217
    vlan 68
    tracking vlan 68 sub 40
    tracking vlan 100 sub 40
    tracking vlan 225 sub 40
    no shutdown
!
vrrp 2
    priority 99
    ip address 192.168.225.9
    vlan 225
    tracking vlan 68 sub 40
    tracking vlan 100 sub 40
    tracking vlan 225 sub 40
    no shutdown
!
ip default-gateway 192.168.68.1
ip route 192.168.0.0 255.255.0.0 null 0
!
router ospf
router ospf router-id 192.168.225.1
router ospf area 10.10.10.10 stub
router ospf redistribute vlan 100,225

```

Chapter 40

External Services Interface

The Dell External Services Interface (ESI) provides an open interface that is used to integrate security solutions that solve interior network problems such as viruses, worms, spyware, and corporate compliance. ESI allows selective redirection of traffic to external service appliances such as anti-virus gateways, content filters, and intrusion detection systems. When “interesting” traffic is detected by these external devices, it can be dropped, logged, modified, or transformed according to the rules of the device. ESI also permits configuration of different server groups—with each group potentially performing a different action on the traffic.

You can configure ESI to do one or more of the following for each group:

- Redirect specified types of traffic to the server
- Perform health checks on each of the servers in the group
- Perform per-session load balancing between the servers in each group
- Provide an interface for the server to return information about the client that can place the client in special roles such as “quarantine”

ESI also provides the ESI syslog parser, which is a mechanism for interpreting syslog messages from third-party appliances such as anti-virus gateways, content filters, and intrusion detection systems. The ESI syslog parser is a generic syslog parser that accepts syslog messages from external devices, processes them according to user-defined rules, and then takes configurable actions on system users.

Topics in this chapter include:

- ["Sample ESI Topology" on page 748](#)
- ["Understanding the ESI Syslog Parser" on page 750](#)
- ["Configuring ESI " on page 752](#)
- ["Sample Route-mode ESI Topology" on page 760](#)
- ["Sample NAT-mode ESI Topology" on page 766](#)
- ["Understanding Basic Regular Expression \(BRE\) Syntax" on page 771](#)



NOTE: The ESI feature requires the Policy Enforcement Firewall Next Generation (PEFNG) license installed on the controller.

Sample ESI Topology

In the example shown in this section, ESI is used to provide an interface to the AntiVirusFirewall (AVF) server device for providing virus inspection services. An AVF server device is one of many different types of services supported in the ESI.

Figure 343: ESI-Fortinet Topology

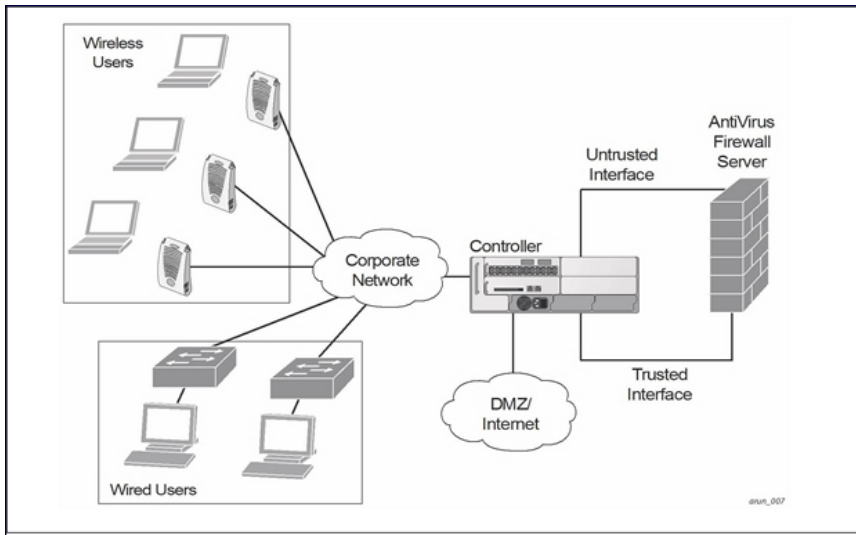

In the ESI-Fortinet topology, the clients connect to access points (both wireless and wired). The wired access points tunnel all traffic back to the over the existing network.", the clients connect to access points (both wireless and wired). The wired access points tunnel all traffic back to the over the existing network.", the clients connect to access points (both wireless and wired). The wired access points tunnel all traffic back to the controller over the existing network.

The controller receives the traffic and redirects relevant traffic (including but not limited to all HTTP/HTTPS and email protocols such as SMTP and POP3) to the AVF server device to provide services such as anti-virus scanning, email scanning, web content inspection, etc. This traffic is redirected on the “untrusted” interface between the controller and the AVF server device. The controller also redirects the traffic intended for the clients coming from either the Internet or the internal network. This traffic is redirected on the “trusted” interface between the controller and the AVF server device. The controller forwards all other traffic (for which the AVF server does not perform any of the required operations such as AV scanning). An example of such traffic would be database traffic running from a client to an internal server.

The controller can also be configured to redirect traffic only from clients in a particular role such as “guest” or “non-remediated client” to the AVF server device. This might be done to reduce the load on the AVF server device if there is a different mechanism such as the Dell-Sygate integrated solution to enforce client policies on the clients that are under the control of the IT department. These policies can be used to ensure that an anti-virus agent runs on the clients and the client can get access to the network only if this agent reports a “healthy” status for the client. Refer to the paper (available from Sygate) on Sygate integrated solutions for more details on this solution.

The controller is also capable of load balancing between multiple external server appliances. This provides more scalability as well as redundancy by using multiple external server appliances. Also, the controller can be configured to have multiple groups of external server devices and different kinds of traffic can be redirected to different groups of devices with load balancing occurring within each group (see [Figure 344](#) for an example).

Figure 344: Load Balancing Groups

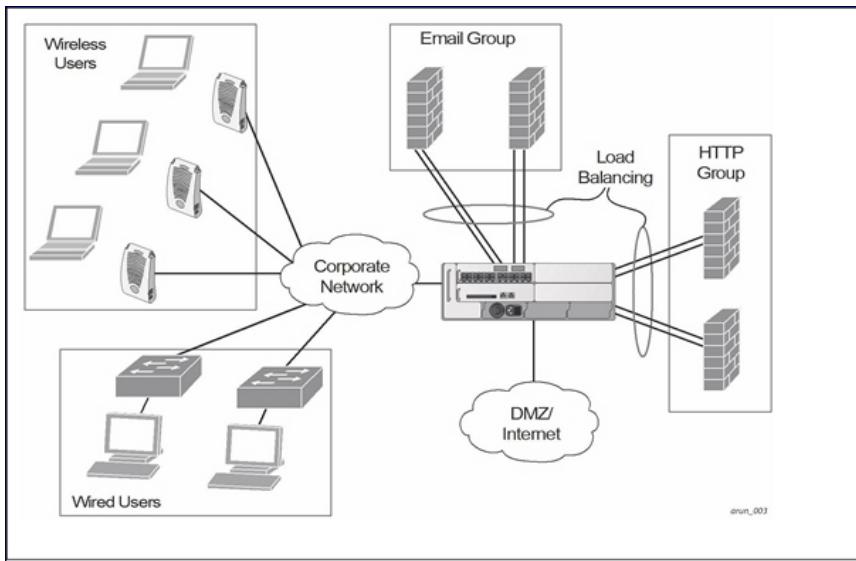

Understanding the ESI Syslog Parser

The ESI syslog parser adds a UNIX-style regular expression engine for parsing relevant fields in messages from third-party appliances such as anti-virus gateways, content filters, and intrusion detection systems.

The user creates a list of rules that identify the type of message, the username to which this message pertains, and the action to be taken when there is a match on the condition.

ESI Parser Domains

The ESI servers are configured into ESI parser domains (see [Figure 345](#)) to which the rules will be applied. This condition ensures that only messages coming from configured ESI parser domains are accepted, and reduces the number of rules that must be examined before a match is detected ("[Syslog Parser Rules](#)" on page 751). messages. When a syslog message is received, it is checked against the list of defined ESI servers. If a server match is found, the message is then tested against the list of predefined rules.

Figure 345: ESI Parser Domains

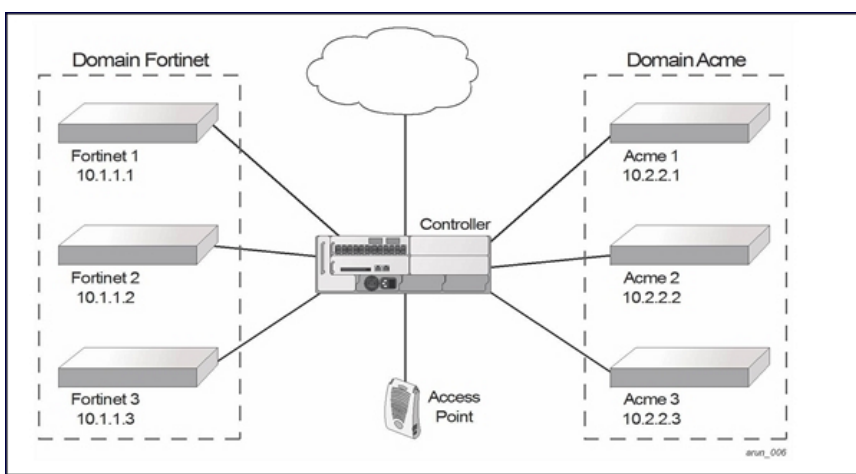

The ESI syslog parser begins with a list of configured IP interfaces which listen for ESI messages. When a syslog message is received, it is checked against the list of defined ESI servers. If a server match is found, the message is then tested against the list of predefined rules.

Within the rule-checking process, the incoming message is checked against the list of rules to search first for a condition match (see ["Syslog Parser Rules" on page 751](#)). If a condition match is made, and the user name can be extracted from the syslog message, the resulting user action is processed by first attempting to look up the user in the local user table. If the user is found, the appropriate action is taken on the user. The default behavior is to look for users only on the local controller. If the user is not found, the event is meaningless and is ignored. This is the typical situation when a single controller is connected to a dedicated ESI server.

Peer Controllers

As an alternative, consider a topology where multiple Dell controllers share one or more ESI servers.

Figure 346: ESI Peer Controllers

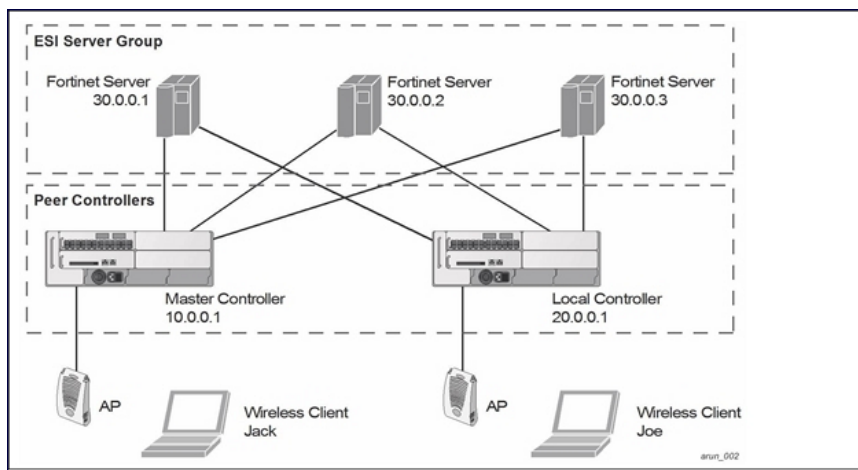

In this scenario, several Dell controllers (master and local) are defined in the same syslog parser domain to act as *peers*. From the standpoint of the ESI servers, because there is no accurate way of determining from which controller a given user came. Thus, the event is flooded out to all Dell controllers defined as peers within this ESI parser domain. The corresponding controller holding the user entry acts on the event, while other Dell controllers ignore the event.

Syslog Parser Rules

The user creates an ESI rule by using characters and special operators to specify a pattern (regular expression) that uniquely identifies a certain amount of text within a syslog message. (Regular expression syntax is described in ["Understanding Basic Regular Expression \(BRE\) Syntax" on page 771](#).) This “condition” defines the type of message and the ESI domain to which this message pertains. The rule contains three major fields:

- Condition: The pattern that uniquely identifies the syslog message type.
- User: The username identifier. It can be in the form of a name, MAC address, or IP address.
- Action: The action to take when a rule match occurs.

Once a condition match has been made, no further rule-matching will be made. For the rule that matched, only one action can be defined.

After a condition match has been made, the message is parsed for the user information. This is done by specifying the target region with the regular expression (REGEX) `regex()` block syntax. This syntax generates two blocks: The

first block is the matched expression; the second block contains the value inside the parentheses. For username matching, the focus is on the second block, as it contains the username.

Condition Pattern Matching

The following description uses the Fortigate virus syslog message format as an example to describe condition pattern matching. The Fortigate virus syslog message takes the form:

```
Sep 26 18:30:02 log_id=0100030101 type=virus subtype=infected src=1.2.3.4
```

This message example contains the Fortigate virus log ID number 0100030101 (“log_id=0100030101”), which can be used as the condition—the pattern that uniquely identifies this syslog message.

The parser expression that matches this condition is “log_id=0100030101”. This is a narrow match on the specific log ID number shown in the message, or “log_id=[0-9]{10}[]”, which is a regular expression that matches any Fortigate log entry with a ten-digit log ID followed by a space.

User Pattern Matching

To extract the user identifier in the example Fortigate virus message shown above (“src=1.2.3.4”), use the following expression, “src=(.*)[]” to parse the user information contained between the parentheses. The () block specifies where the username will be extracted. Only the first block will be processed.

More examples:

Given a message wherein the username is a MAC address:

```
Sep 26 18:30:02 log_id=0100030101 type=virus subtype=infected mac 00:aa:bb:cc:dd:00
```

The expression “mac[](.{17})” will match “mac 00:aa:bb:cc:dd:00” in the example message.

Given a message wherein the username is a user name:

```
Sep 26 18:30:02 log_id=0100030101 type=virus subtype=infected user<johndoe>
```

The expression “user<(.*)>” will match “user<johndoe>” in the example message.

Configuring ESI

You can use the following interfaces to configure and manage ESI and ESI syslog parser behavior:

- The Web user interface (WebUI), which is accessible through a standard Web browser from a remote management console or workstation.
- The command line interface (CLI), which is accessible from a local console device connected to the serial port on the controller or through a Telnet or Secure Shell (SSH) connection from a remote management console or workstation.

NOTE: By default, you can access the CLI only from the serial port or from an SSH session. To use the CLI in a Telnet session, you must explicitly enable Telnet on the controller. The general configuration descriptions in the following sections include both the WebUI pages and the CLI configuration commands. The configuration overview section is followed by several examples that show specific configuration procedures.

In general, there are three ESI configuration “phases” on the controller as a part of the solution:

- The first phase configures the ESI *ping health-check method*, *servers*, and *server groups*. The term *server* here refers to external server devices, for example, an AVF.



- The second phase configures the redirection policies instructing the controller how to redirect the different types of traffic to different server groups.
- The final phase configures the ESI syslog parser domains and the rules that interpret and act on syslog message contents.



NOTE: The procedures shown in the following sections are general descriptions. Your application might be broader or narrower than this example, but the same general operations apply.

Configuring Health-Check Method, Groups, and Servers

To configure the ESI health-check method, servers, and server groups, navigate to the **Configuration > Advanced Services > External Services** view on the WebUI.

In the WebUI

To configure a health check profile:

1. Navigate to the **Configuration > Advanced Services > External Services** page on the WebUI.
2. Click **Add** in the **Health Check Configuration** section.
(To change an existing profile, click **Edit**.)
3. Provide the following details:
 - a. Enter a **Profile Name**.
 - b. **Frequency (secs)**—Indicates how often the controller checks to see if the server is up and running. Default: 5 seconds.
 - c. **Timeout (secs)**—Indicates the number of seconds the controller waits for a response to its health check query before marking the health check as failed. Default: 2 seconds.
 - d. **Retry count**—Is the number of failed health checks after which the controller marks the server as being down. Default: 2.
4. Click **Done** when you are finished.
5. Click **Apply** to apply the configuration changes.

In the CLI

Use these CLI commands to configure a health-check method:

```
esi ping profile_name
      frequency seconds
      retry-count count
      timeout seconds
```

For example:

```
esi ping default
      frequency 5
      retry-count 2
```

Defining the ESI Server

The following sections describe how to configure an ESI server using the WebUI and CLI.

In the WebUI

To configure an ESI server:

1. Navigate to the **Configuration > Advanced Services > External Services** page on the WebUI.
2. Click **Add** in the **External Servers** section.

3. Provide the following details:
 - a. **Server Name.**
 - b. **Server Group.** Use the drop-down list to assign this server to a group from the existing configured groups.
 - c. **Server Mode.** Use the drop-down list to choose the mode (bridge, nat, or route) your topology requires. Refer to the description above to understand the differences between these modes.

For **routed** mode, enter the **Trusted IP Address** (the IP address of the trusted interface on the external server device) and the **Untrusted IP Address** (the IP address of the untrusted interface on the external server device). (You can also choose to enable a health check on either or both of these interfaces.)

For **bridged** mode, enter the **Trusted Port** number (the port connected to the trusted side of the ESI server) and the **Untrusted Port** number (the port connected to the untrusted side of the ESI server).

For **NAT** mode, enter the **Trusted IP Address** (the trusted interface on the external server) and the **NAT Destination Port** number (the port a packet is redirected to rather than the original destination port in the packet). You can also choose to enable a health check on the trusted IP address interface.
4. Click **Done** when you are finished.
5. Click **Apply** to apply the configuration changes..

In the CLI

Use these CLI commands to configure an ESI server and identify its associated attributes:

```
esi server server_identity
  dport destination_tcp/udp_port
  mode {bridge | nat | route}
  trusted-ip-addr ip-addr [health-check]
  trusted-port slot/port
  untrusted-ip-addr ip-addr [health-check]
  untrusted-port slot/port
```

For example:

```
esi server forti_1
  mode route
  trusted-ip-addr 10.168.172.3
  untrusted-ip-addr 10.168.171.3
```

Defining the ESI Server Group

The following sections describe how to configure an ESI server group using the WebUI and CLI.

In the WebUI

To configure an ESI server group on the controller:

1. Navigate to the **Configuration > Advanced Services > External Services** page.
2. Click **Add** in the **Server Groups** section.

(To change an existing group, click **Edit**.)
3. Provide the following details:
 - a. Enter a **Group Name**.
 - b. In the drop-down list, select a health check profile.
4. Click **Done** when you are finished.
5. Click **Apply** to apply the configuration changes.

In the CLI

Use these CLI commands to configure an ESI server group, identify its associated ping health-check method, and associate a server with this group:

```
esi group name
  ping profile_name
  server server_identity
```

For example:

```
esi group fortinet
  ping default
  server forti_1
```

Redirection Policies and User Role

The following sections describe how to configure the redirection policies and user role using the WebUI and CLI.

In the WebUI

To configure user roles to redirect the required traffic to the server(s), navigate to the **Configuration > Access Control > User Roles** view.

1. To add a new role, click **Add**.

To change an existing role, click **Edit** for the firewall policy to be changed. The WebUI displays the **User Roles** tab on top.

2. **Role Name.** Enter the name for the role.

3. To add a policy for the new role, click **Add** in the Firewall Policies section. The WebUI expands the **Firewall Policies** section.

Choose from existing configured policies, create a new policy based on existing policies, or create a new policy.

- a. If you elect to create a new policy, click on the radio button for **Create New Policy** and then click **Create**. The WebUI displays the **Policies** tab.

- b. In the Policies tab:

Policy Name. Provide the policy name and select the IPv4 Session policy type from the drop-down list. The WebUI expands the **Policies** tab.

- c. In the drop-down lists, choose parameters such as source, destination, service in the same way as other firewall policy rules. For certain choices, the WebUI expands and adds drop-down lists.

- d. In the Action drop-down menu, select the **redirect to ESI group** option.

- e. In the Action drop-down menu, select the appropriate ESI group.

- f. Select the traffic direction. **Forward** refers to the direction of traffic from the (untrusted) client or user to the (trusted) server (such as the HTTP server or email server).

- g. To add this rule to the policy, click **Add**.

- h. Repeat the steps to configure additional rules.

- i. Click **Done** to return to the **User Roles** tab. The WebUI returns to the **User Roles** tab.

4. Click **Apply** to apply the configuration changes.

5. Refer to [Roles and Policies on page 296](#), for directions on how to apply a policy to a user role.

In the CLI

Use these commands to define the redirection filter for sending traffic to the ESI server and apply the firewall policy to a user role.

```
ip access-list session policy
```

```

any any any redirect esi-group group direction both blacklist
//For any incoming traffic, going to any destination,
//redirect the traffic to servers in the specified ESI group.
any any any permit
//For everything else, allow the traffic to flow normally.

user-role role
  access-list {eth | mac | session}
  bandwidth-contract name
  captive-portal name
  dialer name
  pool {l2tp | pptp}
  reauthentication-interval minutes
  session-acl name
  vlan vlan_id

```

For example:

```

ip access-list session fortinet
  any any svc-http redirect esi-group fortinet direction both blacklist
  any any any permit

user-role guest
  access-list session fortinet

```

ESI Syslog Parser Domains and Rules

To configure the ESI syslog parser, navigate to the **Configuration > Advanced Services > External Services** view on the WebUI. The following sections describe how to manage syslog parser domains using the WebUI and CLI.

Managing Syslog Parser Domains in the WebUI

Click on the **Syslog Parser Domains** tab to display the Syslog Parser Domains view.

This view lists all the domains by domain name and server IP address, and includes a list of peer Dell controllers (when peer Dell controllers have been configured—as described in ["Understanding the ESI Syslog Parser" on page 750](#)).

Adding a new syslog parser domain

To add a new syslog parser domain:

1. Click **Add** in the **Syslog Parser Domains** section. The system displays the add domain view.
2. In the **Domain Name** text box, type the name of the domain to be added.
3. In the **Server IP Address** text box, type a valid IP address.



NOTE: You must ensure that you type a valid IP address, because the IP address you type is not automatically validated against the list of external servers that has been configured.

4. Click **Add**.
5. Click **Apply**.

Deleting an existing syslog parser domain

To delete an existing parser domain:

1. Identify the target parser domain in the list shown in the **Domain** section of the **Syslog Parser Domains** view.
2. Click **Delete** on the same row in the **Actions** column.

Editing an existing syslog parser domain

To change an existing syslog parser domain:

1. Identify the target parser domain in the list shown in the **Syslog Parser Domains** view .(see "[Managing Syslog Parser Domains in the WebUI](#)" on page 756)
2. Click **Edit** on the same row in the **Actions** column.The system displays the edit domain view.



NOTE: You cannot modify the domain name when editing a parser domain.

3. To delete a server from the selected domain, highlight the server IP address and click **Delete**, then click **Apply** to commit the change.
4. To add a server or a peer controller to the selected domain, type the server IP address into the text box next to the **Add** button, click **Add**, then click **Apply** to commit the change, or click **Cancel** to discard the changes you made and exit the parser domain editing process.

When you make a change in the domain, you can click the **View Commands** link in the lower right corner of the window to see the CLI command that corresponds to the edit action you performed.

Managing Syslog Parser Domains in the CLI

Use these CLI commands to manage syslog parser domains.

Adding a new syslog parser domain

```
esi parser domain name
  peer peer-ip
  server ipaddr
```

Showing ESI syslog parser domain information

```
show esi parser domains
```

Deleting an existing syslog parser domain

```
no esi parser domain name
```

Editing an existing syslog parser domain

```
esi parser domain name
  no
  peer peer-ip
  server ipaddr
```

For example:

```
esi parser domain forti_domain
  server 30.0.0.1
  server 30.0.0.2
  server 30.0.0.3
  peer 20.0.0.1
```

Managing Syslog Parser Rules

The following sections describe how to manage syslog parser rules using the WebUI and CLI.

In the WebUI

Click on the **Syslog Parser Rules** tab to display the Syslog Parser Rules view. This view displays a table of rules with the following columns:

- Name— rule name
- Ena—where “y” indicates the rule is enabled and “n” indicates the rule is disabled (not enabled)
- Condition—Match condition (a regular expression)
- Match—Match type (IP address, MAC address, or user)
- User—Match pattern (a regular expression)
- Set—Set type (blacklist or role)
- Value—Set value (role name)
- Domain—Parser domain to which this rule is to be applied
- Actions—The actions that can be performed on each rule.

Adding a new parser rule

To add a new syslog parser rule:

1. Click **Add** in the **Syslog Parser Rules** view. The system displays the new rule view.
1. In the **Rule Name** text box, type the name of the rule you want to add.
2. Click the **Enable** checkbox to enable the rule.
3. In the **Condition Pattern** text box, type the regular expression to be used as the condition pattern.
For example, “log_id=[0–9]{10}[]” to search for and match a 10-digit string preceded by “log_id=” and followed by one space.
4. In the drop-down **Match** list, use the drop-down menu to select the match type (ipaddr, mac, or user).
5. In the **Match Pattern** text box, type the regular expression to be used as the match pattern.
For example, if you selected “mac” as the match type, type the regular expression to be used as the match pattern. You could use “mac[](.{17})” to search for and match a 17-character MAC address preceded by the word “mac” plus one space.
6. In the drop-down **Set** list, select the set type (blacklist or role).
When you select **role** as the Set type, the system displays a second drop-down list. Click the list to display the possible choices and select the appropriate role value. Validation on the entered value will be based on the Set selection.
7. In the drop-down **Parser Group** list, select one of the configured parser domain names.

Deleting a syslog parser rule

To delete an existing syslog parser rule:

1. Identify the target parser rule in the list shown in the **Syslog Parser Rules** view.
2. Click **Delete** on the same row in the **Actions** column.

Editing an existing syslog parser rule

To change an existing syslog parser rule:

1. Identify the target parser rule in the list shown in the **Syslog Parser Rules** view.
2. Click **Edit** on the same row in the **Actions** column. The system displays the attributes for the selected rule



NOTE: You cannot modify the rule name when editing a parser rule.

3. Change the other rule attributes as required:
 - a. Click the **Enable** checkbox to enable the rule.
 - b. In the **Condition Pattern** text box, type the regular expression to be used as the condition pattern.
 - c. In the drop-down **Match** list, select the match type (ipaddr, mac, or user).
 - d. In the **Match Pattern** text box, type the regular expression to be used as the match pattern.
 - e. In the drop-down **Set** list, select the set type (blacklist or role).
 - f. When you select **role** as the Set type, the system displays a second drop-down list. Click the list to display the possible choices and select the appropriate role value. Validation on the entered value will be based on the Set selection.
 - g. In the drop-down **Parser Group** list, select one of the configured parser domain names.



NOTE: At this point, you can test the rule you just edited by using the Test section of the edit rule view. You can also test rules outside the add or edit processes by using the rule test in the Syslog Parser Test view (accessed from the External Services page by clicking the Syslog Parser Test tab, described in ["Testing a Parser Rule" on page 759](#)).

4. Click **Apply** to apply the configuration changes.

Testing a Parser Rule

You can test or validate enabled Syslog Parser rules against a sample syslog message, or against a syslog message file containing multiple syslog messages. Access the parser rules test from the **External Services** page by clicking the **Syslog Parser Test** tab, which displays the Syslog Parser Rule Test view.

To test against a sample syslog message:

- a. In the drop-down **Test Type** list, select **Syslog message** as the test source type.
- b. In the Message text box, type the syslog message text.
- c. Click **Test** to start the test.

The test results are displayed in a box in the area below the Test button. The test results contain information about the matching rule and match pattern.

- To test against a syslog message file:
 - a. In the drop-down **Test Type** list, select **Syslog file** as the test type.
 - b. In the Filename text box, type the syslog file name.
 - c. Click **Test** to start the test.

The test results are displayed in a box in the area below the Test button. The test results contain information about the matching rule and match pattern.

In the CLI

Use these CLI commands to manage syslog parser rules.

Adding a new parser rule

```
esi parser rule rule-name
  condition expression
  domain name
  enable
  match {ipaddr expression | mac expression | user expression}
  position position
  set {blacklist | role role}
```

For example:

```
esi parser rule forti_virus
```

```
condition "log_id=[0-9]{10}[ ]"  
match "src=(.*)[ ]"  
set blacklist  
enable
```

Showing ESI syslog parser rule information:

```
show esi parser rules
```

Deleting a syslog parser rule:

```
no esi parser rule rule-name
```

Editing an existing syslog parser rule

```
esi parser rule rule-name  
  condition expression  
  domain name  
  enable  
  match {ipaddr expression | mac expression | user expression}  
  no  
  position position  
  set {blacklist | role role}
```

Testing a parser rule

```
esi parser rule rule-name  
  test {file filename | msg message}
```

Monitoring Syslog Parser Statistics

The following sections describe how to monitor syslog parser statistics using the WebUI and CLI.

In the WebUI

You can monitor syslog parser statistics in the External Servers monitoring page, accessed by selecting **Monitoring > Switch > External Services Interface > Syslog Parser Statistics**.

The Syslog Parser Statistics view displays statistics such as the number of matches and number of users per rule, as well as the number of respective actions fired by the syslog parser.



NOTE: The Syslog Parser Statistics view also displays the last refresh time stamp and includes a **Refresh Now** button, to allow the statistics information to be refreshed manually. There is no automatic refresh on this page.

In the CLI

```
show esi parser stats
```

Sample Route-mode ESI Topology

This section introduces the configuration for a sample route-mode topology using the controller and Fortinet Anti-Virus gateways. In route mode, the trusted and untrusted interfaces between the controller and the Fortinet gateways are on different subnets. The following figure shows an example route-mode topology.



NOTE: ESI with Fortinet Anti-Virus gateways is supported only in route mode.

Figure 347: Example Route-Mode Topology

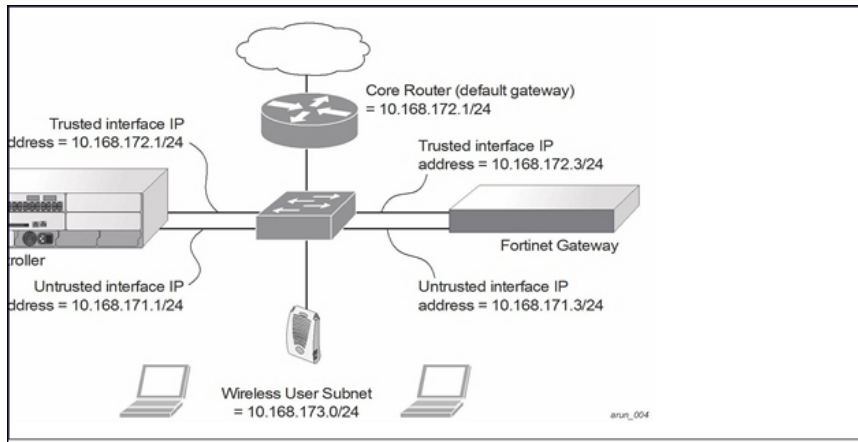

In the topology shown, the following configurations are entered on the controller and Fortinet gateway:

ESI server configuration on controller

- Trusted IP address = 10.168.172.3 (syslog source)
- Untrusted IP address = 10.168.171.3
- Mode = route

IP routing configuration on Fortinet gateway

- Default gateway (core router) = 10.168.172.1
- Static route for wireless user subnet (10.168.173.0/24) through the controller (10.168.171.2)

Configuring the Example Routed ESI Topology

This section describes how to implement the example routed ESI topology shown in . The description includes the relevant configuration—both the WebUI and the CLI configuration processes are described—required on the controller to integrate with a AVF server appliance.

The ESI configuration process will redirect all HTTP user traffic to the Fortinet server for examination, and any infected user will be blacklisted. The configuration process consists of these general tasks:

- Defining the ESI server.
- Defining the default ping health check method.
- Defining the ESI group.
- Defining the HTTP redirect filter for sending HTTP traffic to the ESI server.
- Applying the firewall policy to the guest role.
- Defining ESI parser domains and rules.

There are three configuration “phases” on the controller as a part of the solution.

- The first phase configures the ESI *ping health-check method*, *servers*, and *server groups*. The term *server* here refers to external AVF server devices.
- In the second phase of the configuration task, the user roles are configured with the redirection policies (session ACL definition) instructing the controller to redirect the different types of traffic to different server groups.
- In the final phase, the ESI parser domains and rules are configured.



NOTE: The procedures shown in the following sections are based on the requirements in the example routed ESI topology. Your application might be broader or narrower than this example, but the same general operations apply.

Health-Check Method, Groups, and Servers

To configure the ESI health-check method, servers, and server groups, navigate to the **Configuration > Advanced Services > External Services** view on the WebUI.

Defining the Ping Health-Check Method

In the WebUI

To configure a health check profile:

1. Navigate to the **Configuration > Advanced Services > External Services** page on the WebUI.
2. Click **Add** in the **Health Check Configuration** section.
To change an existing profile, click **Edit**.
3. Provide the following details:
 - a. Enter the name **default for the Profile Name**.
 - b. **Frequency (secs)**—Enter 5.)
 - c. **Timeout (secs)**—Indicates the number of seconds the controller waits for a response to its health check query before marking the health check as failed. Default: 2 seconds. (In this example, enter 3.)
 - d. **Retry count**—Is the number of failed health checks after which the controller marks the server as being down. Default: 2. (In this example, enter 3.)
4. Click **Done** when you are finished.
5. Click **Apply**.

In the CLI

Use these CLI commands to configure a health-check method:

```
esi ping profile_name
    frequency seconds
    retry-count count
    timeout seconds
```

For example:

```
esi ping default
    frequency 5
    retry-count 3
    timeout 3
```

Defining the ESI Server

The following sections describe how to configure an ESI server using the WebUI and CLI.

In the WebUI

To configure an ESI server:

1. Navigate to the **Configuration > Advanced Services > External Services** page on the WebUI.
2. Click **Add** in the **External Servers** section.
3. Provide the following details:
 - a. **Server Name**. (This example uses the name **forti_1**.)

- b. **Server Group.** Use the drop-down list to assign this server to a group from the existing configured groups. (This example uses **fortinet**.)
 - c. **Server Mode.** Use the drop-down list to choose the mode (bridge, nat, or route) your topology requires. Refer to the description above to understand the differences between the modes. (This example uses **route** mode.)
 - d. **Trusted IP Address.** Enter 10.168.172.3.)
 - e. **Untrusted IP Address.** Enter 10.168.171.3.)
4. Click **Done** when you are finished.
 5. Click **Apply** to apply the configuration changes.

In the CLI

Use these CLI commands to configure an ESI server and identify its associated attributes:

```
esi server server_identity
  dport destination_tcp/udp_port
  mode {bridge | nat | route}
  trusted-ip-addr ip-addr [health-check]
  trusted-port slot/port
  untrusted-ip-addr ip-addr [health-check]
  untrusted-port slot/port
```

For example:

```
esi server forti_1
  mode route
  trusted-ip-addr 10.168.172.3
  untrusted-ip-addr 10.168.171.3
```

Defining the ESI Server Group

The following sections describe how to configure an ESI server group using the WebUI and CLI.

In the WebUI

To configure an ESI server group on the controller:

1. Navigate to the **Configuration > Advanced Services > External Services** page.
2. Click **Add** in the **Server Groups** section.
3. Provide the following details:
 - a. Enter a **Group Name**. Enter **fortinet**.)
 - b. In the drop-down list, select **default** as the health check profile.
4. Click **Done** when you are finished.
5. Click **Apply** to apply the configuration changes.

In the CLI

Use these CLI commands to configure an ESI server group, identify its associated ping health-check method, and associate a server with this group:

```
esi group name
  ping profile_name
  server server_identity
```

For example:

```
esi group fortinet
  ping default
  server forti_1
```

Redirection Policies and User Role

The following sections describe how to configure the redirection policies and user role using the WebUI and CLI.

In the WebUI

To configure user roles to redirect the required traffic to the server(s), navigate to the **Configuration > Access Control > User Roles** view (see 1).

1. To add a new role, click **Add**. The WebUI displays the **Add Role** view.
Role Name. Enter “guest” as the name for the role.
2. To add a policy for the new role, click **Add** in the Firewall Policies section. The WebUI expands the **Firewall Policies** section.

Choose from existing configured policies, create a new policy based on existing policies, or create a new policy.

- a. If you elect to create a new policy, click on the radio button for **Create New Policy** and then click **Create**. The WebUI displays the **Policies** tab.

- b. In the Policies tab:

Policy Name. Enter the policy name **fortinet** and the **IPv4 Session** policy type.) Click **Add** to proceed. The WebUI expands the **Policies** tab.

In the drop-down lists, choose parameters such as source, destination, service in the same way as other firewall policy rules. This example uses **any** source, **any** destination, service type **svc-http (tcp 80)**. For certain choices, the WebUI expands and adds drop-down lists.

- c. In the Action drop-down menu, select the **redirect to ESI group** option.

Select **fortinet** as the appropriate ESI group.

The three steps above translate to “for any incoming HTTP traffic, going to any destination, redirect the traffic to servers in the ESI group named fortinet.”)

Select **both** as the traffic direction. **Forward** refers to the direction of traffic from the untrusted client or user to the trusted server, such as the HTTP server or email server.

To add this rule to the policy, click **Add**.

- d. Repeat the steps to configure additional rules. This example adds a rule that specifies **any, any, any, permit**.
 - e. Click **Done** to return to the **User Roles** tab.
3. Click **Apply** to apply the configuration changes.
 4. Refer to [Roles and Policies on page 296](#), for directions on how to apply a policy to a user role.

In the CLI

Use these commands to define the redirection filter for sending traffic to the ESI server and apply the firewall policy to a user role in the route-mode ESI topology example.

```
ip access-list session policy
  any any any redirect esi-group group direction both blacklist
  //For any incoming traffic, going to any destination,
  //redirect the traffic to servers in the specified ESI group.
  any any any permit
  //For everything else, allow the traffic to flow normally.

user-role role
  access-list {eth | mac | session}
  bandwidth-contract name
  captive-portal name
  dialer name
  pool {l2tp | pptp}
  reauthentication-interval minutes
```

```
session-acl name
vlan vlan_id
```

For example:

```
ip access-list session fortinet
  any any svc-http redirect esi-group fortinet direction both blacklist
  any any any permit
user-role guest
access-list session fortinet
```

Syslog Parser Domain and Rules

The following sections describe how to configure the syslog parser domain and rules for the route-mode example using the WebUI and CLI.

Add a New Syslog Parser Domain in the WebUI

To add a new syslog parser domain for the routed example:

1. Click **Add** in the **Syslog Parser Domains** tab (**Advanced Services > External Services > Syslog Parser Domain**).
The system displays the new domain view.
2. In the **Domain Name** text box, type the name of the domain to be added.
3. In the **Server (IP Address)** text box, type a valid IP address.



NOTE: You must ensure that you type a valid IP address, because the IP address you type is not automatically validated against the list of external servers that has been configured.

4. Click **<< Add**.
5. Click **Apply**.

Adding a New Parser Rule in the WebUI

To add a new syslog parser rule for the route-mode example:

1. Click **Add** in the **Syslog Parser Rules** tab (**Advanced Services > External Services > Syslog Parser Rule**).
The system displays the new rule view.
2. In the **Rule Name** text box, type the name of the rule to be added (in this example, “forti_virus”).
3. Click the **Enable** checkbox to enable the rule.
4. In the **Condition Pattern** text box, type the regular expression to be used as the condition pattern. (In this example, the expression “log_id=[0-9]{10}[]” searches for and matches a 10-digit string preceded by “log_id=” and followed by one space.)
5. In the drop-down **Match** list, use the drop-down menu to select the match type (in this example, ipaddr).
6. In the **Match Pattern** text box, type the regular expression to be used as the match pattern (in this example, “src=(.*)[]”).
7. In the drop-down **Set** list, select the set type (in this example, blacklist).
8. In the drop-down **Parser Group** list, select one of the configured parser domain names (in this example, “forti_domain”).
9. Click **Apply**.

In the CLI

Use these CLI commands to define a syslog parser domain and the rule to be applied in the route-mode example shown in [Figure 347](#)

```
esi parser domain name
```

```
peer peer-ip
server ipaddr
```

```
esi parser rule rule-name
  condition expression
  domain name
  enable
  match {ipaddr expression | mac expression | user expression }
  position position
  set {blacklist | role role}
```

For example:

```
esi parser domain forti_domain
server 10.168.172.3
```

```
esi parser rule forti_virus
  condition "log_id=[0-9]{10}[ ]"
  match ipaddr "src=(.*)[ ]"
  set blacklist
  enable
```

Sample NAT-mode ESI Topology

This section describes the configuration for a sample NAT-mode topology using the controller and three external captive-portal servers. NAT mode uses a trusted interface for each external captive-portal server and a different destination port to redirect a packet to a port other than the original destination port in the packet. An example topology is shown below in [Figure 349](#).

Figure 348: Example NAT-Mode Topology

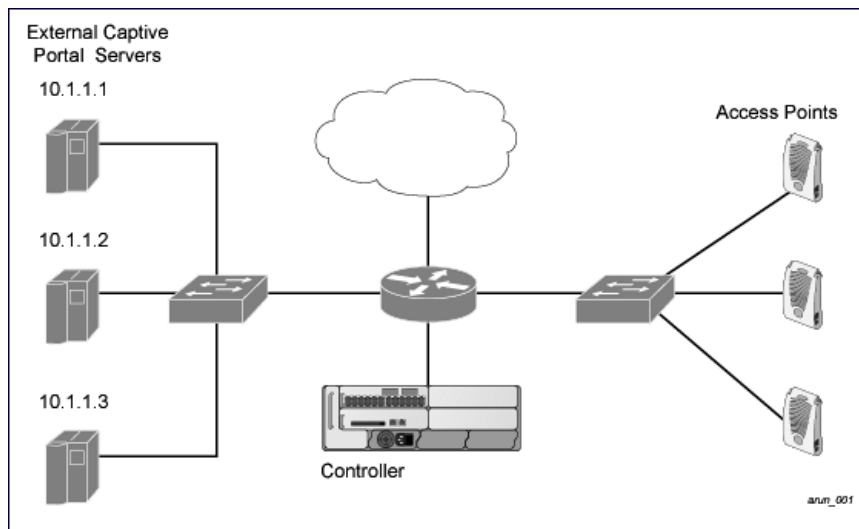
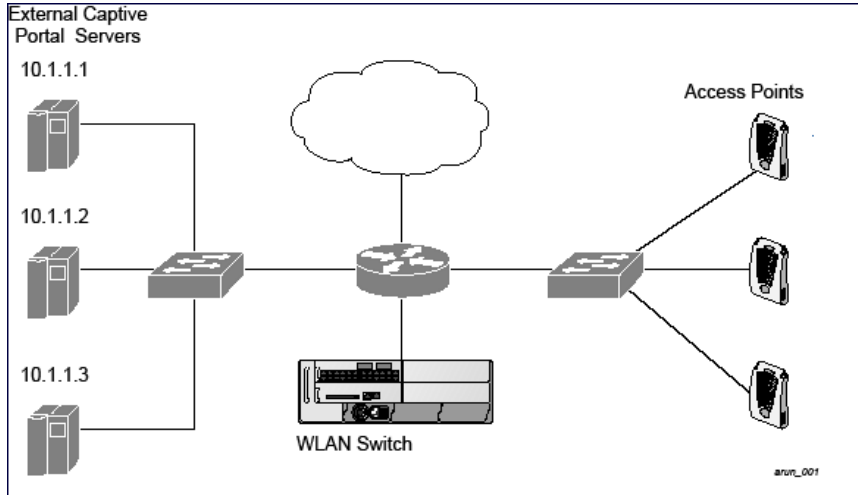

Figure 349:



In this example, all HTTP traffic received by the controller is redirected to the external captive portal server group and load-balanced across the captive portal servers. All wireless client traffic with destination port 80 is redirected to the captive portal server group, with the new destination port 8080.



NOTE: The external servers do not necessarily have to be on the subnet as the controller. The policy that redirects traffic to the external servers for load balancing is routed to the external servers if they are on a different subnet.

In the topology shown, the following configurations are entered on the controller and external captive-portal servers:

ESI server configuration on the controller

- External captive-portal server 1:
 - Name = external_cp1
 - Mode = NAT
 - Trusted IP address = 10.1.1.1
 - Alternate destination port = 8080
- External captive-portal server 2:
 - Name = external_cp2
 - Mode = NAT
 - Trusted IP address = 10.1.1.2
- External captive-portal server 3:
 - Name = external_cp3
 - Mode = NAT
 - Trusted IP address = 10.1.1.3
- Health-check ping:
 - Name = externalcp_ping
 - Frequency = 30 seconds
 - Retry-count = 2 attempts
 - Timeout = 2 seconds (2 seconds is the default)

- ESI group = external_cps
- Session access control list (ACL)
 - Name = cp_redirect_acl
 - Session policy = user any svc-http redirect esi-group external_cps direction both

Configuring the Example NAT-mode ESI Topology

This section describes how to implement the example NAT-mode ESI topology shown in using both the WebUI, then the CLI.

The configuration process consists of these general tasks:

- Configuring captive portal (see the “Configuring Captive Portal” chapter).
- Configuring the health-check ping method.
- Configuring the ESI servers.
- Configuring the ESI group.
- Defining the redirect filter for sending traffic to the ESI server.

Configuring the NAT-mode ESI Example in the WebUI

Navigate to the **Configuration > Advanced Services > External Services** view on the WebUI (see).

In the WebUI

1. Click **Add** in the **Health-Check Configuration** section **External Services** view on the WebUI.
2. Provide the following details:
 - a. **Profile Name**. This example uses **externalcp_ping**.
 - b. **Frequency** seconds. This example uses **30**.
 - c. **Retry Count**. This example uses **3**.



NOTE: If you do not specify a value for a parameter, the WebUI assumes the default value. In this example, the desired timeout value is two seconds; therefore, not specifying the timeout causes the WebUI to use the default value of two seconds.

3. Click **Done** when you are finished.



NOTE: To apply the configuration (changes), you must click **Apply** in the **External Services** view on the WebUI. In this example, you can wait until you finish configuring the servers and groups, or you can apply after each configuration portion.

Configuring the ESI Group in the WebUI

1. Click **Add** in the **Server Groups** section **External Services** view on the WebUI.
2. Provide the following details:
 - a. **Group Name**. This example uses **external_cps**.
 - b. **Health-Check Profile**. Select the health-check ping from the drop-down list. This example uses **externalcp_ping**.
3. Click **Done** when you are finished.



NOTE: To apply the configuration (changes), you must click **Apply** in the **External Services** view on the WebUI. In this example, you can wait until you finish configuring the servers and groups, or you can apply after each configuration portion.

Configure the ESI Servers in the WebUI

1. Click **Add** in the **External Servers** section.
2. Provide the following details:
 - a. **Server Name**.
 - b. **Server Group**. Use the drop-down list to assign this server to a group from the existing configured groups.
 - c. **Server Mode**. Use the drop-down list to choose NAT mode.)
 - d. **Trusted IP Address**. For nat mode, enter the IP address of the trusted interface on the external captive portal server.
 - e. **NAT Destination Port**. Enter the port number (to redirect a packet to a port other than the original destination port in the packet).
3. Click **Done** when you are finished.
4. Repeat Step 1 through Step 3 for the remaining external captive portal servers.
5. Click **Apply** to apply the configuration changes.

Configuring the Redirection Filter in the WebUI

To redirect the required traffic to the server(s) using the WebUI, navigate to the **Configuration > Access Control > User Roles** view on the WebUI (see 1).

1. Click the **Policies** tab.
2. Click **Add** in the **Policies** section of the **Policies** view on the WebUI.
3. Provide the following details:
 - a. **Policy Name**. (This example uses `cp_redirect_acl`.)
 - b. **Policy Type**. Select **IPv4 Session** from the drop-down list.
4. Click **Add** in the **Rules** section of the **Policies** view.
 - a. **Source**. Select **user** from the drop-down list.
 - b. **Destination**. Accept **any**.
 - c. **Service**. Select **service** from the drop-down list; select **svc-http (tcp 80)** from the secondary drop-down list.
 - d. **Action**. Select **redirect to ESI group** from the drop-down list; select **external_cps** from the secondary drop-down list; click **<--** to add that group.
 - e. Click **Add**.
5. Click **Done** when you are finished.
6. Click **Apply** to apply the configuration changes.

Configuring the Example NAT-mode Topology in the CLI

The CLI configuration process consists of these general tasks:

- Configuring captive portal (see [Captive Portal Authentication on page 233](#)).
- Configuring the health-check ping method.
- Configuring the ESI servers.
- Configuring the ESI group.
- Defining the redirect filter for sending traffic to the ESI server.

Configuring a Health-Check Ping

The health-check ping will be associated with an ESI group, along with servers, so that controller will send ICMP echo requests to each server in the group and mark the server down if the controller does not hear from the server. The health-check parameters used in this example are:

- Frequency—30 seconds. (The default is 5 seconds.)
- Retry-count—3. (The default is 2.)
- Timeout—2 seconds. (The default is 2 seconds.)

Use these CLI commands to configure a health-check ping method:

```
esi ping profile_name
  frequency seconds
  retry-count count
  timeout seconds
```

Configuring ESI Servers

Here are the ESI server CLI configuration tasks:

- Configure server mode to be NAT.
- Configure the trusted IP address (the server IP address to which packets should be redirected).
- To redirect to a different port than the original destination port in the packet, configure an alternate destination port.

Use these CLI commands to configure an ESI server and identify its associated attributes:

```
esi server server_identity
  dport destination_tcp/udp_port
  mode {bridge | nat | route}
  trusted-ip-addr ip-addr [health-check]
```

Configure an ESI Group, Add the Health-Check Ping and ESI Servers

Use these CLI commands to configure an ESI server group, identify its associated ping health-check method, and associate a server with this group:

```
esi group name
  ping profile_name
  server server_identity
```

Using the ESI Group in a Session Access Control List

Use these CLI commands to define the redirection filter for sending traffic to the ESI server.

```
ip access-list session_policy
  user any svc-http redirect esi-group group direction both
```

CLI Configuration Example 1

```
esi ping externalcp_ping
  frequency 30
  retry-count 3

esi server external_cp1
  dport 8080
  mode nat
  trusted-ip-addr 10.1.1.1

esi server external_cp2
  dport 8080
  mode nat
```

```

trusted-ip-addr 10.1.1.2

esi server external_cp3
  dport 8080
  mode nat
  trusted-ip-addr 10.1.1.3

esi group external_cps
  ping externalcp_ping
  server external_cp1
  server external_cp2
  server external_cp3

ip access-list session cp_redirect_acl
  user any svc-http redirect esi-group external_cps direction both

```

CLI Configuration Example 2

```

esi server https-proxy1
  dport 44300
  mode nat
  trusted-ip-addr 1.2.3.4

esi server https-proxy2
  dport 44300
  mode nat
  trusted-ip-addr 1.2.3.5

esi group https-proxies
  ping default
  server https-proxy1
  server https-proxy2

ip access-list session https-proxy
  user any svc-https redirect esi-group https-proxies direction both
  any any permit

```

Understanding Basic Regular Expression (BRE) Syntax

The ESI syslog parser supports regular expressions created using the Basic Regular Expression (BRE) syntax described in this section. BRE syntax consists of instructions—character-matching operators (described in [Table 350](#)), repetition operators (described in [Table 351](#)), or expression anchors (described in [Table 352](#))—used to defined the search or match target.

This section contains the following topics:

- “Character-Matching Operators” on page 512
- “Regular Expression Repetition Operators” on page 513
- “Regular Expression Anchors” on page 513
- “References” on page 514

Character-Matching Operators

Character-matching operators define what the search will match.

Table 350: *Character-matching operators in regular expressions*

Operator	Description	Sample	Result
.	Match any one character.	grep .ord sample.txt	Matches <i>ford, lord, 2ord</i> , etc. in the file sample.txt.
[]	Match any one character listed between the brackets	grep [cng]ord sample.txt	Matches only <i>cord, nord</i> , and <i>gord</i>
[^]	Match any one character not listed between the brackets	grep [^cn]ord sample.txt	Matches <i>lord, 2ord</i> , etc., but not <i>cord</i> or <i>nord</i>
		grep [a-zA-Z]ord sample.txt	Matches <i>aord, bord, Aord, Bord</i> , etc.
		grep [^0-9]ord sample.txt	Matches <i>Aord, aord</i> , etc., but not <i>2ord</i> , etc.

Regular Expression Repetition Operators

Repetition operators are *quantifiers* that describe how many times to search for a specified string. Use them in conjunction with the character-matching operators in [Table 351](#) to search for multiple characters.

Table 351: *Regular expression repetition operators*

Operator	Description	Sample	Result
?	Match any character one time if it exists	egrep "?erd" sample text	Matches <i>berd, herd</i> , etc., <i>erd</i>
*	Match declared element multiple times if it exists	egrep "n.*rd" sample.txt	Matches <i>nerd, nrd, neard</i> , etc.
+	Match declared element one or more times	egrep "[n]+erd" sample.txt	Matches <i>nerd, nnerd</i> , etc., but not <i>erd</i>
{n}	Match declared element exactly <i>n</i> times	egrep "[a-z]{2}erd" sample.txt	Matches <i>cherd, blerd</i> , etc., but not <i>nerd, erd, buzzerd</i> , etc.
{n,}	Match declared element at least <i>n</i> times	egrep ":{2,}erd" sample.txt	Matches <i>cherd</i> and <i>buzzerd</i> , but not <i>nerd</i>
{n,N}	Match declared element at least <i>n</i> times, but not more than <i>N</i> times	egrep "n[e]{1,2}rd" sample.txt	Matches <i>nerd</i> and <i>neerd</i>

Regular Expression Anchors

Anchors describe where to match the pattern, and are a handy tool for searching for common string combinations. Some of the anchor examples use the vi line editor command `:s`, which stands for *substitute*. That command uses the syntax: `s/pattern_to_match/pattern_to_substitute`.

Table 352: Regular expression anchors

Operator	Description	Sample	Result
<code>^</code>	Match at the beginning of a line	<code>s/^/blah /</code>	Inserts "blah" at the beginning of the line
<code>\$</code>	Match at the end of a line	<code>s\$/ blah/</code>	Inserts " blah" at the end of the line
<code>\<</code>	Match at the beginning of a word	<code>s/\</blah/</code>	Inserts "blah" at the beginning of the word
		<code>egrep "\<blah" sample.txt</code>	Matches <i>blahfield</i> , etc.
<code>\></code>	Match at the end of a word	<code>s/\>/blah/</code>	Inserts "blah" at the end of the word
		<code>egrep "\>blah" sample.txt</code>	Matches <i>soupblah</i> , etc.
<code>\b</code>	Match at the beginning or end of a word	<code>egrep "\bblah" sample.txt</code>	Matches <i>blahcake</i> and <i>countblah</i>
<code>\B</code>	Match in the middle of a word	<code>egrep "\Bblah" sample.txt</code>	Matches <i>sublahper</i> , etc.

References

This implementation is based, in part, on the following resources:

- Lonvick, C., "The BSD syslog Protocol", RFC 3164, August 2001
- Regular expression (regex) reference: http://en.wikipedia.org/wiki/Regular_expression
- Regex syntax summary: <http://www.greenend.org.uk/rjk/2002/06/regexp.html>
- Basic regular expression (BRE) syntax: <http://builder.com.com/5100-6372-1050915.html>

Chapter 41

External User Management

This chapter introduces the ArubaOS XML API interface and briefly discusses how you can use the simple API calls to perform external user management tasks. A sample code listing at the end of the chapter to help you get started with using the XML API.

Topics in this chapter include:

- ["Overview" on page 774](#)
- ["Working with the ArubaOS XML API Works" on page 774](#)
- ["Creating an XML Request" on page 775](#)
- ["XML Response" on page 776](#)
- ["Sample Code" on page 784](#)

Overview

ArubaOS allows you to set up customized external captive portal user management using its native XML API interface. The XML API interface allows you to create and execute user management operations on behalf of the clients or users. You can use the XML API interface to add, delete, authenticate, or query a user or a client.

Before you Begin

- Enable the External Services Interface software module. This is available in the PEFNG license.
- Ensure that you have connectivity between your captive portal server and the Dell controllers via HTTP or HTTPS.

Working with the ArubaOS XML API Works

The typical interaction between your external server and the controller happens over HTTPS post commands. A typical communication process using the XML API interface happens as follows:

1. An API command is issued from your server in XML format to the controller. The XML message or request can be composed using a language of your choice using the format described in the ["Creating an XML Request" on page 775](#). Sample code in *C* gives a simple example. See the ["Sample Code" on page 784](#).
2. The controller processes the XML request and sends the response to the authentication server in the XML format. The XML request is sent using HTTPS post. The common format of the HTTPS post is `https://<controller-ip>/auth/command.xml`. See ["Creating an XML Request" on page 775](#) for more information.
3. You can use the response and take appropriate action that suit your requirements. The response from the controller is returned using predefined formats. See the ["XML Response" on page 776](#) for more information.

Creating an XML Request

You can create XML requests to add, delete, authenticate, blacklist, or query a user. This section provides XML request formats that you can use for each authentication tasks:

Adding a User

This XML requests uses the `user_add` command to create a new user entry in the Dell controllers user table. If the user entry is already present in the user table, the command will modify the entry with the values defined in the XML request.

```
xml=<aruba command="user_add">
  <ipaddr>IP-address_of_the_user</ipaddr>
  <macaddr>MAC-address_of_the_user</macaddr>
  <name>User_Name</name>
  <role>Role_Name</role>
  <session_timeout>Session_timeout</session_timeout>
  <key>Shared_Key</key>
  <authentication>MD5|SHA-1|cleartext</authentication>
  <version>1.0</version>
</aruba>
```

The following options are mandatory when you execute the `user_add` command:

- IP Address
- Version

Deleting a User

This XML requests uses the `user_delete` command to delete an existing user from the Dell controllers user table. If the user entry contains multiple attributes these must be specified in the XML request

```
xml=<aruba command="user_delete">
  <ipaddr>IP-address_of_the_user</ipaddr>
  <macaddr>MAC-address_of_the_user</macaddr>
  <name>User_Name</name>
  <key>Shared_Key</key>
  <authentication>MD5|SHA-1|cleartext</authentication>
  <version>1.0</version>
</aruba>
```

The following options are mandatory when you execute the `user_add` command:

- IP Address
- Version

Authenticating a User

This XML requests uses the `user_authenticate` command to authenticate and derive a new for the user.

```
xml=<aruba command="user_authenticate">
  <ipaddr>IP-address_of_the_user</ipaddr>
  <macaddr>MAC-address_of_the_user</macaddr>
  <name>User_Name</name>
  <password>Password_for_the_user</password>
  <key>Shared_Key</key>
  <authentication>MD5|SHA-1|cleartext</authentication>
  <version>1.0</version>
</aruba>
```

The following options are mandatory when you execute the `user_authenticate` command:

- IP Address
- Version
- Name
- Password

Blacklisting a User

This XML requests uses the `user_blacklist` command to blacklist a user from connecting to your network.

```
xml=<aruba command="user_blacklist">
  <ipaddr>IP-address_of_the_user</ipaddr>
  <macaddr>MAC-address_of_the_user</macaddr>
  <name>User_Name</name>
  <key>Shared_Key</key>
  <authentication>MD5|SHA-1|cleartext</authentication>
  <version>1.0</version>
</aruba>
```

The following options are mandatory when you execute the `user_blacklist` command:

- IP Address
- Version

Querying for User Status

This XML requests uses the `user_query` command to get the status and details of a user connected to your network.

```
xml=<aruba command="user_query">
  <ipaddr>IP-address_of_the_user</ipaddr>
  <macaddr>MAC-address_of_the_user</macaddr>
  <name>User_Name</name>
  <key>Shared_Key</key>
  <authentication>MD5|SHA-1|cleartext</authentication>
  <version>1.0</version>
</aruba>
```

The following options are mandatory when you execute the `user_blacklist` command:

- IP Address
- Version

XML Response

For every successful XML request the controller will return the processed information as an XML response. There are two types of responses: Default response and Query response.

Default Response Format

The format of a default XML response from the controller is:

```
<aruba>
  <result>Error | Ok</result>
  <code>response_code</code>
  <reason>response_message</reason>
```

</aruba>

In which,

- Result specifies if the XML result was successful or failure. If the request was successful, the result tag will contain the **ok** string. If the request was a failure, the result tag will contain the **Error** string.
- Code is an integer number that represents the error in the request. This tag is populated only if there is an error in the request.
- Reason is message that contain descriptive information about error.

Response Codes

The following response codes are returned if the XML request return an the Error string.

Table 353: XML Response Codes

Code	Reason message	Description
1	unknown user The user specified in the XML request does not exist or is incorrect.	Returned by the user_authenticate, user_delete, user_blacklist, and user_query commands.
2	unknown role The specified role in the XML request does not exist in the controller.	Returned by the user_add command.
3	unknown external agent	Returned by all commands.
4	authentication failed The username and the key does not match.	Returned by commands that contain the shared_key in XML request.
5	invalid command The XML request contains a command not supported by ArubaOS XML API interface.	—
6	invalid message authentication method The authentication method specified in the XML request is not supported by the ArubaOS XML API interface.	Returned by commands that contain the authentication method in the XML request.
7	invalid message digest	Returned by commands that contain the shared_key in the XML request.
8	missing message authentication The authentication method is not specified in the XML request.	Returned by all commands that require the authentication method in the XML request.
9	missing or invalid version number The XML request does not contain the version number or the version number is incorrect.	Returned by all commands.
10	internal error	
11	client not authorized The shared key in the XML request does not match or the XML API server is not defined in the appropriate AAA profile.	Returned by all commands that require shared key to be specified in the XML request.
12	Cant use VLAN IP	—

Code	Reason message	Description
13	Invalid IP The XML request contains invalid IP address of the user or client.	Returned by all commands that required IP address to be specified in the XML request.
14	Cant use Switch IP The XML request contains the Dell controllers IP address instead of the client IP address.	Returned by all commands that required IP address to be specified in the XML request.
15	missing MAC address The XML request does not contain the MAC address of the user or client.	Returned by all commands that required MAC address to be specified in the XML request.

Query Command Response Format

The response of the XML request with the `user_query` command contains detailed information about the status of the user or client. The format of the response of a query command is:

```
<aruba>
  <result>Result</result>
  <code>Code</code>
  <reason>Reason</reason>
  <role>Role</role>
  <type>Type</type>
  <auth_status>Auth_status</auth_status>
  <auth_server>Auth_server</auth_server>
  <auth_method>Auth_method</auth_method>
  <location>Location</location>
  <age>Age</age>
  <ssid>Essid</ssid>
  <bssid>Bssid</bssid>
  <phy_type>Phy_type</phytype>
  <vlan>Vlan</vlan>
</aruba>
```

In which, the result, code and reason values are similar to the default response. The following responses, however, are returned only in the result code returns the **OK** string.

Table 354: Query Response Code

Response Code	Description
Role	Displays the current role of the authenticated user
Type	Displays is the user or client is wired or wireless .
Auth_status	Displays the authentication status of the user or client. Available values are: authenticated or unauthenticated .
Auth_server	Displays the name of the authentication server used for authenticating the user. This information is available only if the user is authenticated by the controller.
Auth_method	Displays the authentication mechanism used to authenticate the user. This information is available only if the user is authenticated by the controller.
Location	Displays the current location of the user / clients. For wireless clients, the location is displayed in the

Response Code	Description
	B.F.L format. For wired clients, the location is displayed in the slot/port format.
Age	Displays the age of user in the controller. The age is displayed in DD:HH:MM format (Day:Hours:Minutes).
ESSID	Displays the ESSID to which the user is associated.
BSSID	Displays the BSSID of the AP to which the user is associated.
Phy Type	Displays the physical connection type. One of a, b, or g.
Vlan	Displays the VLAN ID of the user.

Using the XML API Server

To use the XML API:

1. Configure an external XML API server
2. Associate the XML API server to an appropriate AAA profile
3. Configure a user role to direct un-authenticated users to the external captive portal server
4. Configure Captive Portal profile and associate that to an initial role (example logon)
5. Create an XML request with the appropriate API call
6. Process XML response appropriately



NOTE: The default logon role of a client or user must have captive-portal enabled.

Configuring the XML API Server

Configure an external XML API server in your AAA infrastructure. In this example, **10.11.12.13** is your server. The XML API interface on the controller will receive requests from this server.

- Define the XML API server and specify the key for verifying requests from your server

```
(host) (config) #aaa xml-api server 10.11.12.13
(host) (XML API Server "10.11.12.13") #key $abcd$1234$
```

- Verify the XML API server configuration

```
(host) (config) #show aaa xml-api server
XML API Server List
```

```
-----
Name           References  Profile Status
----           -
10.11.12.13  1
is incremented for each usage.
```

```
Total:1
```

Associating the XML API Server to a AAA profile

After you define the XML API server profile associate it to the appropriate AAA profile. If the XML API server is not correctly configured in the appropriate profile, the controller will respond with the `client not authorized` error message. You can add XML API server references to the following AAA profile depending on your requirement:

- For wireless users—Associate the XML API server to the AAA profile of the virtual AP profile.

```
(host) (config) #aaa profile wirelesusers
(host) (AAA Profile "wirelesusers") #xml-api-server 10.11.12.13
(host) (XML API Server "10.11.12.13") #key Dell123
(host) (config) #show aaa profile wirelesusers
```

AAA Profile "wirelesusers"

```
-----
Parameter                               Value
-----
Initial role                             logon
MAC Authentication Profile                N/A
MAC Authentication Default Role          guest
MAC Authentication Server Group          default
802.1X Authentication Profile            N/A
802.1X Authentication Default Role       guest
802.1X Authentication Server Group      N/A
RADIUS Accounting Server Group           N/A
XML API server                           10.11.12.13
RFC 3576 server                          N/A
User derivation rules                    N/A
Wired to Wireless Roaming                Enabled
SIP authentication role                  N/A
```

```
(host) (config) #wlan virtual-ap wireless-vap
(host) (Virtual AP profile "wireless-vap") #aaa-profile wirelesusers
(host) (config) #show wlan virtual-ap wireless-vap
```

Virtual AP profile "wireless-vap"

```
-----
Parameter                               Value
-----
Virtual AP enable                        Enabled
Allowed band                             all
AAA Profile                              wirelesusers
802.11K Profile                          default
SSID Profile                             default
VLAN                                       N/A
Forward mode                             tunnel
Deny time range                         N/A
Mobile IP                                 Enabled
HA Discovery on-association               Disabled
DoS Prevention                           Disabled
Station Blacklisting                     Enabled
Blacklist Time                           3600 sec
Dynamic Multicast Optimization (DMO)     Disabled
Dynamic Multicast Optimization (DMO) Threshold 6
Authentication Failure Blacklist Time    3600 sec
Multi Association                         Disabled
Strict Compliance                        Disabled
VLAN Mobility                             Disabled
Remote-AP Operation                      standard
Drop Broadcast and Multicast              Disabled
Convert Broadcast ARP requests to unicast Disabled
Band Steering                             Disabled
WMM Traffic Management Profile            N/A
```

- For wired users—Associate the XML API server to the AAA profile of the appropriate wired profile.

```
(host) (config) #aaa profile wiredusers
```

```
(host) (AAA Profile "wiredusers") #xml-api-server 10.11.12.13
(host) (AAA Profile "wiredusers") #!
(host) (config) #aaa authentication wired
(host) (Wired Authentication Profile) #profile wiredusers
(host) (Wired Authentication Profile) #show aaa authentication wired
```

Wired Authentication Profile

```
-----
Parameter      Value
-----
AAA Profile    wiredusers
```

- Unknown wired users—Associate the XML API server to the default-xml-api AAA profile.



NOTE: The default-xml-api AAA profile is used only to add or authenticate new users.

The following example illustrates using the default-xml-api AAA profile.

```
(host) (config) #aaa profile default-xml-api
(host) (AAA Profile "default-xml-api") #xml-api-server 10.11.12.13
(host) (config) #show aaa profile default-xml-api
AAA Profile "default-xml-api" (Predefined (changed))
```

```
-----
Parameter                                             Value
-----
Initial role                                          logon
MAC Authentication Profile                            N/A
MAC Authentication Default Role                       guest
MAC Authentication Server Group                      default
802.1X Authentication Profile                         N/A
802.1X Authentication Default Role                   guest
802.1X Authentication Server Group                  N/A
RADIUS Accounting Server Group                       N/A
XML API server                                       10.11.12.13
RFC 3576 server                                      N/A
User derivation rules                                N/A
Wired to Wireless Roaming                           Enabled
SIP authentication role                              N/A
```

Your controller is now ready to receive API calls from your XML API server.

Set up Captive Portal profile

Set up a Captive Portal profile with a login page that will redirect users to the external Captive Portal server.

```
(host) (config-role) #aaa authentication captive-portal captive-portal-auth
(host) (Captive Portal Authentication Profile "captive-portal-auth") #default-role
authenticated
(host) (Captive Portal Authentication Profile "captive-portal-auth") #login-page
https://10.11.12.13/cgi-bin/login.pl
(host) (Captive Portal Authentication Profile "captive-portal-auth") #switch-in-redirection-
url
```

Associating the Captive Portal Profile to an Initial Role

```
(host) (Captive Portal Authentication Profile "captive-portal-auth") #user-role logon

(host) (config-role) #captive-portal captive-portal-auth
(host) (config-role) #session-acl captiveportal
```

You can either create a new ACL or append specific rules to an existing ACLs. To create session ACL for the logon role do the following:

```
(host) (config-role) #netdestination xCP #an alias for the external Captive Portal server
(host) (config-dest) #host 10.11.12.13 #IP address of the external Captive Portal server
(host) (config-dest) #ip access-list session captiveportal #append or add rules to session ACL
(host) (config-sess-captiveportal)#user alias xCP svc-https permit
(host) (config-sess-captiveportal)#user alias xCP svc-http permit
```

Creating an XML API Request

You can now create an XML request with an appropriate authentication command and send it to the controller via HTTPS post. The format of the URL to send the XML request is:

`https://<controller-ip/auth/command.xml`

- `controller-ip` is the IP address of the controller that will receive the authentication request
- `command.xml` is the XML request that contains the details of authentication.

The format of the XML API request is:

```
xml=<aruba command="<authentication_command">
  <options>Value</options>
  ...
  <options>Value</options>
</aruba>
```

You can specify any of the following commands in the XML request:

Table 355: XML API Authentication Command

Authentication Command	Description
<code>user_add</code>	This command adds the user to the Dell controllers user table.
<code>user_delete</code>	This command deletes the user from the controller
<code>user_authenticate</code>	This command will authentication the user based on the authentication rules defined in the Dell controllers configuration.
<code>user_blacklist</code>	This command will block a user from connection to your network.
<code>user_query</code>	This command will display the current status of the user connected to your network.

The authentication command requires certain mandatory options to successfully execute the authentication tasks. The list of all available options are:

Table 356: Authentication Command Options

Options	Description	Range / Defaults
<code>ipaddr</code>	IP address of the user in A.B.C.D format.	—
<code>macaddr</code>	MAC address of the user aa:bb:cc:dd:ee:ff format.	Enter MAC address with colon.
<code>user</code>	Name of the user.	64 character string

Options	Description	Range / Defaults
role	Role name assigned after authenticating.	64 character string
password	The password of the user used for authentication.	—
session_timeout	Session time-out in seconds. User will be disconnected after this time.	—
authentication	Authentication method used to authenticate the message and the sender. You can use any of MD5, SHA-1 or clear text methods of authentication. This option is ignored if shared secret is not configured. It is, however, mandatory if it is configured.	—
key	This is the encoded SHA1/MD5 hash of shared secret or plaintext shared secret. This option is ignored if shared secret is not configured on the switch. The actual MD5/SHA-1 hash is 16/20 bytes and consists of binary data. It must be encoded as an ASCII based HEX string before sending. It must be present when the controller is configured with an xml-api key for the server. Encoded hash length is 32/40 bytes for MD5/SHA-1.	
version	The version of the XML API interface available in the controller. This field is mandatory in all requests.	Current version 1.0

Monitoring External Captive Portal Usage Statistics

To check the external captive portal authentication statistics use the `show aaa xml-api statistics` command. This command displays the number of times an authentication command was executed per client. The command also displays the number of times an authentication event occurred and the number of new authentication events that occurred since the last status check.

```
(host) # show aaa xml-api statistics
ECP Statistics
-----
Statistics                               10.10.10.249
-----
user_authenticate                         1 (0)
user_add                                  1 (0)
user_delete                               1 (0)
user_blacklist                            2 (0)
unknown user                              2 (0)
unknown role                              0 (0)
unknown external agent                    0 (0)
authentication failed                     0 (0)
invalid command                           0 (0)
invalid message authentication method      0 (0)
invalid message digest                    0 (0)

Packets received from unknown clients : 0 (0)
Packets received with unknown request : 0 (0)
Requests Received/Success/Failed        : 5/3/2 (0/0/0)
```

Sample Code

This section lists a sample code that will help you get started in using the ArubaOS XML API interface. These codes have been tested in a controlled environment. We recommend that you test this code in a non-production environment before using it for actual user management tasks.

Using XML API in C Language

The example script is written in the C language. The example script (`auth.c`) sends an authentication request from your authentication server to the controller.



NOTE: This is an example code and is provided for illustration purposes. If you plan to use this code in your environment, ensure that the code meets your IT guidelines. Also create an error free executable to successfully execute the script.

Figure 357: Authentication Script Listing

```
##### auth.c listing
##### Authentication Script Example -- Start --
#include <stdio.h>
#include <sys/types.h>
#include <sys/socket.h>
#include <netinet/in.h>
#include <getopt.h>

char *command, *ipaddr, *macaddr;
char *name, *password, *role;
char *tout, *secret;
char *auth, *key, enchashbuf[41];
unsigned char hashbuf[20];
char *version;

char post[4096], cmdbuf[512], encbuf[1024];

#define DEBUG
#ifdef DEBUG
#define debug(x...)      fprintf(stderr, x)
#else
#define debug(x...)
#endif

extern int cgi_escape_url(char *t, int tl, char *s, int sl, int b_newline);
static void encode_message_digest (unsigned char *md, int mdlen, char *output);

static void usage (void)
{
    fprintf(stderr, "Usage: ecp [options] <switch> <command> [<secret>]\n");

    fprintf(stderr, " \n");
    fprintf(stderr, " <switch>      Switch IP address.\n");
    fprintf(stderr, " <command>     One of add, del, or authenticate.\n");
    fprintf(stderr, " <secret>      Shared secret.\n");
    fprintf(stderr, " \n");

    fprintf(stderr, " -i ipaddr     User IP address in A.B.C.D format.\n");
    fprintf(stderr, " -m macaddr    User MAC address in aa:bb:cc:dd:ee:ff format.\n");
    fprintf(stderr, " -n name       User name.\n");
    fprintf(stderr, " -p passwd     User password.\n");
    fprintf(stderr, " -r role       User role.\n");
    fprintf(stderr, " -t timeout    User session timeout.\n");
    fprintf(stderr, " -v version    API version number. Default is 1.0\n");
}
```



```

    fprintf(stderr, " -a method      one of md5, sha-1 or cleartext.\n");

    exit(1);
}

main(int argc, char **argv)
{
    char c, *p;
    int fd, len, postlen;
    struct sockaddr_in sa;

    while ((c = getopt(argc, argv, "a:i:m:n:p:r:t:v:")) != EOF) switch(c) {
        case 'i':      /* ipaddr */
            ipaddr = optarg;
            break;
        case 'm':      /* macaddr */
            macaddr = optarg;
            break;
        case 'n':      /* name */
            name = optarg;
            break;
        case 'p':      /* password */
            password = optarg;
            break;
        case 'r':      /* role */
            role = optarg;
            break;
        case 't':      /* session timeout */
            tout = optarg;
            break;
        case 'v':      /* version */
            version = optarg;
            break;
        case 'a':      /* authentication */
            auth = optarg;
            if (!strcasecmp(auth, "sha-1") &&
                !strcasecmp(auth, "md5"))
                usage();
            break;
        default:
            usage();
            break;
    }
    argc -= (optind - 1);
    argv += (optind - 1);

    if ((argc < 3)) {
        usage();
    }
    if (version == NULL)
        version = "1.0";

    debug("server=%s, command=%s, version=%s, secret=%s\n",
          argv[1], argv[2], version, argv[3]?argv[3]:"<>");

    if (argv[3]) secret = argv[3];

    p = cmdbuf;
    sprintf(p, "xml=<aruba command='%s'>", argv[2]);
    p += strlen(p);
    if (ipaddr) {

```

```

        sprintf(p, "<ipaddr>%s</ipaddr>", ipaddr);
        p += strlen(p);
    }
    if (macaddr) {
        sprintf(p, "<macaddr>%s</macaddr>", macaddr);
        p += strlen(p);
    }
    if (name) {
        sprintf(p, "<name>%s</name>", name);
        p += strlen(p);
    }
    if (password) {
        sprintf(p, "<password>%s</password>", password);
        p += strlen(p);
    }
    if (role) {
        sprintf(p, "<role>%s</role>", role);
        p += strlen(p);
    }
    if (tout) {
        sprintf(p, "<session timeout>%s</session timeout>", tout);
        p += strlen(p);
    }
    if (secret) {
        if (auth == NULL) {
            key = secret;
            auth = "cleartext";
#ifdef OPENSAL_NO_SHA1
        } else if (!strcasecmp(auth, "sha-1")) {
            key = enchashbuf;
            SHA1(secret, strlen(secret), hashbuf);
            encode_message_digest(hashbuf, 20, enchashbuf);
#endif
        } else if (!strcasecmp(auth, "md5")) {
            key = enchashbuf;
            md5_calc(hashbuf, secret, strlen(secret));
            encode_message_digest(hashbuf, 16, enchashbuf);
        }
        debug("Message authentication is %s (%s)\n", auth, key);
        sprintf(p, "<authentication>%s</authentication><key>%s</key>",
            auth, key);
        p += strlen(p);
    }
    debug("\n");
    sprintf(p, "<version>%s</version>", version);
    sprintf(p, "</authresponse>");
    cgi_escape_url(encbuf, sizeof(encbuf), cmdbuf, strlen(cmdbuf), 0);

    postlen = sprintf(post,
        "POST /auth/command.xml HTTP/1.0\r\n"
        "User-Agent: ecp\r\n"
        "Host: %s\r\n"
        "Pragma: no-cache\r\n"
        "Content-Length: %d\r\n"
        /* "Content-Type: application/x-www-form-urlencoded\r\n" */
        "Content-Type: application/xml\r\n"
        "\r\n"
        "%s",
        argv[1], strlen(encbuf), encbuf);

    inet_aton(argv[1], &sa.sin_addr);

```

```

sa.sin_family = AF_INET;
sa.sin_port = htons(80);
fd = socket(AF_INET, SOCK_STREAM, 0);
if (fd < 0) {
    perror("socket");
    exit(1);
}
if (connect(fd, (struct sockaddr *) &sa, sizeof(sa)) < 0) {
    perror("connect");
    exit(1);
}

if (write(fd, post, postlen) != postlen) {
    perror("write");
    exit(1);
}

while ((len = read(fd, post, sizeof(post))) > 0)
    write(1, post, len);
close(fd);
exit(0);
}

static void encode_message_digest (unsigned char *md, int mdlen, char *output)
{
    int i;

    for (i=0; i<mdlen; i++) {
        sprintf(output, "%02x", md[i]);
        output += 2;
    }
}

}

##### Authentication Script Example -- END --

```

Understanding Request and Response

The controller processes the authentication task and sends a response to the authentication server in the XML format to the authentication server. The XML response contains the status of the request and a code in case of an error. The example script is listed in [Figure 357](#).

Request format: <script_name> [options] <controller-ip> <command> <secret_key>

Understanding XML API Request Parameters

The [Table 358](#) list all parameter that you can use in a request.

Table 358: XML API Request Parameters and Descriptions

Parameter	Description
script_name	The name of the script executable.
Options	<ul style="list-style-type: none"> • -i <ip_addr>—Specify the client's IP address. • -m <mac_addr>—Specify the client's MAC address. • -n <name>—Specify the client's user name. • -p <passwd>—Specify the client password.

Parameter	Description
	<ul style="list-style-type: none"> -r role—Specify the current user role of the client. -t timeout—User session timeout. -v version—API version number. Default is 1.0 -a method—Specify the encryption method to send the secret key. You can specify MD5 or SHA-1 or cleartext as the encryption method. By default, cleartext method is used to send the key. -s sessid—Active session Id
controller-ip	The IP address of the controller that will receive the authentication requests.
command	<p>The authentication command sent to the controller. You can send one of the following commands per request:</p> <ul style="list-style-type: none"> add: Adds the client to your network. delete: Deletes the client from your network query: Fetches information about the client blacklist: Blacklists or block the client from connecting to your network authenticate: Authenticates the client and assigns the default authenticated role.
secret_key	The password used to validate the authentication request from your authentication server. See "Configuring the XML API Server" on page 779 for more information.

Understanding XMI API Response

The response message from the controller is sent in an XML format. The default format of the response is:

```
[Message header]
Displays the request parameters and other standard header details.
..
...
..

<response>
  <status>Status Message</status>
  <code>Code in case of an error</code>
</response>
```

Adding a Client

This command will add a client on your network.

Figure 359: Adding a client—request and response

```
john@linux:/home/john/tools/xml-api# ./auth -i 10.10.10.249 -m 00:19:d2:01:0b:aa -r logon
10.11.12.13 add $abcd$1234$
```

The commands sends the following information in the authentication request to the controller:

- Client IP address: **10.10.10.249**
- Client MAC address: **00:19:d2:01:0b:aa**
- Authentication server IP address: **10.11.12.13**
- Authentication command: **add**
- Key to validate authentication request: **\$abcd\$1234\$**
- Verification key is sent in cleartext format

Response from the controller

```
server=10.11.12.13, command=add, version=1.0, secret=$abcd$1234$ sessid=
Message authentication is cleartext ($abcd$1234$)
```

```
HTTP/1.1 200 OK
Date: Tue, 03 Aug 2010 23:32:16 GMT
Server:
Connection: close
Content-Type: text/xml
```

```
<authresponse>
  <status>Ok</status>
  <code>0</code>
</authresponse>
```

View the updated details of the client on the controller

```
(host) #show user-table

Users
-----
   IP           MAC           Name      Role      Age(d:h:m)  Auth      .....
-----
10.10.10.249  00:19:d2:01:0b:aa  logon     logon     00:00:00    ----    ... [truncated]
-----
User Entries: 1/1
```

Deleting a Client

This command will delete a client from your network. Deleting a client—request and response

```
john@linux:/home/john/tools/xml-api# ./auth -i 10.10.10.248 10.11.12.13 delete $abcd$1234$
```

This command sends the following information in the request to the controller:

- Client IP address: **10.10.10.248**
- Authentication server IP address: **10.11.12.13**
- Authentication command: **delete**
- Key to validate authentication request: **\$abcd\$1234\$**
- Key is sent in cleartext format

Response from the controller

```
server=10.11.12.13, command=delete, version=1.0, secret=$abcd$1234$ sessid=
Message authentication is cleartext ($abcd$1234$)
```

```
HTTP/1.1 200 OK
Date: Tue, 03 Aug 2010 23:30:32 GMT
Server:
Content-Length: 56
Connection: close
Content-Type: text/xml
```

```
<authresponse>
  <status>Ok</status>
  <code>0</code>
</authresponse>
```

Authenticating a Client

This command will authenticate and change the role of a client. To illustrate the authentication command request process this section displays status of the client before and after the authentication command request.

Status of the client before authentication

The following `show user` command shows the role of the client is `logon` before the authentication request is processed by the controller.

```
(host) #show user

Users
-----
   IP           MAC           Name      Role      Age (d:h:m)  Auth      ....
-----
10.10.10.248   00:19:d2:01:0b:84   -----   logon     00:00:00     ----   ... [truncated]
User Entries: 1/1
```

The following command shows the captive portal status of the `logon` role of the client.

```
(host) (config-role) #show rights logon | include "Captive Portal profile"
Captive Portal profile = default
```

Sending the authentication command

Use the `authenticate` keyword in the script to send the authentication command request.

Figure 360: Authenticating the client—request and response

```
john@linux:/home/john/tools/xml-api# ./auth -i 10.10.10.248 -n john -p password 10.11.23.24
authenticate $abcd$1234$
```

This command sends the following information in the request to the controller:

- Client IP address: **10.10.10.248**
- Client username: **john**
- Client password: **password**
- Authentication server IP address: **10.11.12.13**
- Authentication command: **authenticate**
- Key to validate authentication request: **\$abcd\$1234\$**
- Key is sent in cleartext format

Response from the controller

```
server=10.11.12.13, command=authenticate, version=1.0, secret=$abcd$1234$ sessid=
Message authentication is cleartext ($abcd$1234$)
```

```
HTTP/1.1 200 OK
Date: Tue, 03 Aug 2010 23:23:42 GMT
Server:
Connection: close
Content-Type: text/xml
```

```
<authresponse>
  <status>Ok</status>
  <code>0</code>
</authresponse>
```

Status of the client after authentication

The following `show user` command shows the role of the client is change to `guest` after the authentication request is processed by the controller.

```
(host) (config) #show user
Users
-----
      IP             MAC             Name  Role    Age (d:h:m)  Auth  ....
-----
10.10.10.248  00:19:d2:01:0b:84  John  guest  00:00:04    Web  ....
User Entries: 1/1
```

Querying for Client Details

This command will fetch all details about a client connected in your network. Querying Client Information—request and response

```
john@linux:/home/john/tools/xml-api# ./auth -i 10.10.10.249 10.11.12.13 query $abcd$1234$
```

This command sends the following information in the request to the controller:

- Client IP address: **10.10.10.249**
- Client username: **john**
- Client password: **password**
- Authentication server IP address: **10.11.12.13**
- Authentication command: **query**
- Key to validate authentication request: **\$abcd\$1234\$**
- Key is sent in cleartext format

Response from the controller

```
server=10.11.12.13, command=query, version=1.0, secret=$abcd$1234$ sessid=
Message authentication is cleartext ($abcd$1234$)
```

```
HTTP/1.1 200 OK
Date: Tue, 03 Aug 2010 23:34:30 GMT
Server:
Connection: close
Content-Type: text/xml
```

```
<authresponse>
  <status>Ok</status>
  <code>0</code>
  <macaddr>00:19:d2:01:0b:aa</macaddr>
  <name>john</name>
  <role>logon</role>
  <type>Wireless</type>
  <vlan>1</vlan>
  <location>N/A</location>
  <age>00:00:02</age>
  <auth_status>Unauthenticated</auth_status>
  <ssid></ssid>
  <bssid>00:00:00:00:00:00</bssid>
  <phy_type>b</phy_type>
  <mobility_state>Wireless</mobility_state>
  <in_packets>0</in_packets>
  <in_octets>0</in_octets>
  <out_packets>0</out_packets>
  <out_octets>0</out_octets>
</authresponse>
```

The output of the `show user` command displays the client information.

```

Users
-----
   IP             MAC             Name      Role      Age(d:h:m)  Auth      ....
-----
10.10.10.249  00:19:d2:01:0b:aa  John     logon     00:00:01    -----  ... [truncated]
                                     -----  ....

User Entries: 1/1

```

Blacklisting a Client

This command will blacklist a client and restrict it from connecting to your network. The `show user-table` lists the client connected on your network before processing the request to blacklist the client.

```

Users
-----
   IP             MAC             Name      Role      Age(d:h:m)  ....
-----
10.10.10.248  00:19:d2:01:0b:84  John     guest     00:00:00    -----  ... [truncated] ...
                                     -----  ....

User Entries: 1/1

```

Figure 361: Blacklisting a Client—request and response

```
john@linux:/home/john/tools/xml-api# ./auth -i 10.10.10.248 10.11.12.13 blacklist $abcd$1234$
```

This command sends the following information in the request to the controller:

- Client IP address: **10.10.10.248**
- Authentication server IP address: **10.11.12.13**
- Authentication command: **blacklist**
- Key to validate authentication request: **\$abcd\$1234\$**
- Key is sent in cleartext format

Response from the controller

```
server=10.11.12.13, command=blacklist, version=1.0, secret=$abcd$1234$ sessid=
Message authentication is cleartext ($abcd$1234$)
```

```
HTTP/1.1 200 OK
Date: Tue, 03 Aug 2010 23:29:11 GMT
Server:
Content-Length: 56
Connection: close
Content-Type: text/xml
```

```
<authresponse>
  <status>Ok</status>
  <code>0</code>
</authresponse>
```

The `show user-table` command does not list the blacklisted client. You can use the `show ap blacklist-clients` command on your controller to view the list of blacklisted clients

```

(host) (config) #show ap blacklist-clients

Blacklisted Clients
-----
STA           reason      block-time(sec)  remaining time(sec)
---           -
00:19:d2:01:0b:84  user-defined  5                3595

```

RF Plan is a wireless deployment modeling tool that helps you design an efficient Wireless Local Area Network (WLAN) that optimizes coverage and performance, without complicated WLAN network setup. RF Plan provides the following critical functionality:

- Defines WLAN coverage.
- Defines WLAN environment security coverage.
- Assesses equipment requirements.
- Optimizes radio resources.

RF Plan provides a view of each floor, allowing you to specify how you want to provide wireless coverage for each area. RF Plan also generates coverage maps with AP and AM placement.



NOTE: Use this feature with deployments of less than 150 APs in a master/local domain, or for deployments where a standalone controller is using 50% of its AP capacity *or* a maximum of 150 APs, whichever is lower. Larger deployments should use the Dell PowerConnect W-AirWave VisualRF tool for AP location tracking.

Unlike other static site survey tools that require administrators to have intricate knowledge of building materials and other potential radio frequency (RF) hazards, RF Plan calibrates coverage in real-time through a sophisticated RF calibration algorithm. This real-time calibration lets you characterize the indoor propagation of RF signals to determine the best channel and transmission power settings for each AP. You can program the calibration to occur automatically or you can manually launch the calibration at any time to quickly adapt to changes in your wireless environment.

Topics in this chapter include:

- ["Supported Planning" on page 793](#)
- ["Planning a WLAN According to Your Specifications" on page 448](#)
- ["Launching the RF Plan" on page 796](#)
- ["Using the FQLN Mapper in the AP Provision Page" on page 817](#)
- ["RF Plan Example" on page 818](#)

Supported Planning

All the features included in the WebUI RF Plan tool will aid you in the planning 802.11n standard compliant deployments.

This WebUI RF Plan supports planning of the following types of deployments:

- **802.11n Deployments**—The RF Plan now supports planning of network environments that use the Dell's AP-12x series of indoor access points, which are 802.11n compliant. RF Plan supports the planning of these APs in the following capacity: 802.11a/n, 802.11b/g/n, or 802.11a/b/g/n.

- **802.11n Hotspot Deployment within an Existing Environment**—This type of environment requires that AP/AM locations be fixed at the building level, see ["Fix All Suggested AP/AMs" on page 813](#). If you set and fix the location of APs prior to planning for the 802.11n APs, the APs will not move when you initialize/optimize the 802.11n AP locations.
- **802.11n Hotspot Deployment and New Environment**—The RF Plan allows you to plan for a new deployment that uses an 802.11n hotspot and 802.11a and/or 802.11 b/g support outside of the hotspot.
To plan for this type of deployment, start by planning your 802.11n hotspot. When you initialize and optimize the APs planned for the hotspot, the 802.11n APs are placed within the hotspot area. However, the same AP type will also be placed outside of the hotspot area with 802.11n support disabled.
RF Plan will deploy APs outside of the hotspot area based on the 802.11a and/or 802.11b/g rates defined by the system. For the system to define 802.11a and/or 802.11b/g rates, the system looks at the defined 802.11n rate and the distance covered by the defined rate; it then selects corresponding 802.11a and/or 802.11b/g rates based on the distance covered.

Planning Deployment

Dell recommends the following when planning and deploying a mesh solution:

Pre-Deployment Considerations

- Stage the APs before deployment. Identify the location of the APs, configure them for mesh, provision them and verify connectivity before physically deploying the mesh APs in a live network.
- Ensure the controller has Layer-2/3 network connectivity to the network segment where you plan to install the mesh portal.
- Keep the AP packaging materials and reuse them to send the APs to the installation location.
- Verify the layout of the physical location to determine the appropriate configuration and placement of the APs. Use this information to avoid problems that would necessitate a physical recovery.
- Label the AP before sending it to the physical location for installation.

Outdoor-Specific Deployment Considerations

- Provision the AP with the latitude and longitude coordinates of the installation location. This allows you to more easily identify the AP for inventory and troubleshooting purposes.
- Identify a “radio line of sight” between the antennas for optimum performance. The radio line of sight involves the area along a link through which the bulk of the radio signal power travels.
- Identify the minimum antenna height required to ensure a reliable mesh link.
- Scan your proposed site to avoid radio interference caused by other radio transmissions using the same or an adjacent frequency.
- Consider extreme weather conditions known to affect your location, including: temperature, wind velocity, lightning, rain, snow, and ice.
- Allow for seasonal variations, such as growth of foliage.

For more detailed outdoor deployment information, refer to the *Installation Guide* that came with your outdoor AP.

Configuration Considerations

- On dual-radio APs, you can configure only one of the radio for mesh. If you want a dual-radio AP to carry mesh backhaul traffic and client services traffic on separate radios, Dell recommends using 802.11a radios for mesh-backhaul traffic and 802.11g radios for traditional WLAN access.

- If you configure more than one mesh node in the same VLAN, prevent network loops by enabling STP on the Layer-2 switch used to connect the mesh nodes.
- Mesh nodes learn a maximum of 1024 source MAC addresses; this cannot be changed.
- Place all APs for a specific mesh cluster in the same AP group.
- Create and keep separate mesh cluster profiles for specific mesh clusters. Do not overwrite or delete the cluster profiles.
- Enable bridging on mesh point Ethernet ports when deploying LAN bridging solutions.
- APs configured as mesh points support secure jack operation on enet0. APs with multiple Ethernet ports configured as mesh *portals* support secure jack operation on enet1. If an AP with multiple Ethernet ports is configured as a mesh *point*, it supports secure jack operation on enet1 and enet0.
- Mesh networks forward tagged/untagged VLAN traffic, but do not tag traffic. The allowed VLANs are controlled by the wired ap profile.
- Mesh APs provisioned on different Dell controllers can interoperate if those APs are configured with the same country code, cluster name and cluster key. Note, however, that the mesh recovery profile created on one controller is not able to recover settings for mesh APs provisioned on another controller unless the recovery profile is on a master controller and the other mesh nodes were provisioned by a local controller connected to that master.

Post-Deployment Considerations

- Do not connect mesh point Ethernet ports in such a way that causes a network loop.
- Have a trained professional install the AP. After installation, check to ensure the AP receives power and boots up, enabling RSSI outputs.



NOTE: Although the AP is up and operational, it is not connected to the network.

- Align the AP antenna for optimal RSSI.
- Do not delete or modify mesh cluster profiles once you use them to provision mesh nodes. You can recover the mesh point if the original cluster profile is still available. Dell recommends creating a new mesh cluster profile if needed.
- If you create a new mesh cluster profile for an existing deployment, you must re-provision the AP for the new profile to take effect. If you re-provision mesh nodes that are already operating, re-provision the most distant (highest hop count) mesh points first followed by the mesh portals. If you re-provision the mesh portal first, the mesh points may be unable to form a mesh link. Note that re-provisioning the AP causes it to automatically reboot, which may cause a disruption of service to the network.

Dual-Port AP Considerations

The W-AP130 Series and W-AP120 Series models have The AP-12x model has two 10/100 Mbps Ethernet ports (enet0 and enet1, respectively). When using these APs in a mesh environment, note the following Ethernet port requirements:

- If configured as a mesh portal:
 - Connect enet0 to the controller to obtain an IP address. The wired AP profile controls enet1.
 - Only enet1 supports secure jack operation.
- If configured as a mesh point, enet0 and enet1 can be configured using separate wired-port-profiles. However, the wired-ap-profile for enet0 is also applied to enet1.

Launching the RF Plan

This section describes how to launch the RF Plan and enter information in RF Plan windows.

To launch RF Plan from the WebUI, click the **Plan** tab in the WebUI menu bar. When you launch the RF Plan, the browser window displays the Campus List page.

Campus List Page

The Campus List is the first page you see when you start RF Plan. This list contains a default campus and any campus you have defined using the RF Plan software.

Figure 362: *Plan>Campus List Window*

Monitoring	Configuration	Diagnostics	Maintenance	Plan	Events	Reports
Plan > Campus List						
Search Results						
<input type="checkbox"/>	Name ▲	Buildings	Modified Time ▼			
<input type="checkbox"/>	Branch Campus	1	19:52:48 9/28/2010			
<input type="checkbox"/>	Main Campus	2	19:52:48 9/28/2010			
<input type="checkbox"/>	Remote Office	1	19:52:48 9/28/2010			
1 1-3 of 3 10 ▼						
<input type="button" value="New Campus"/> <input type="button" value="Browse Campus..."/> <input type="button" value="Rename Campus"/> <input type="button" value="Delete Campuses"/> <input type="button" value="Export"/>						

You may add, edit, and delete campuses using this page. You may also import and export campus information. [Table 363](#) details the buttons on the Campus page.

Table 363: *Definition of Campus List Buttons*

Buttons	Description
New Campus	Use this button to create a new campus.
Browse Campus	Use this button to edit existing campuses from the campus list. To edit a campus, select the checkbox next to the campus name, then click Browse Campus . When you edit a campus, you can access other RF Plan pages.
Rename Campus	Use this button to rename an existing campus in the list. To rename a campus, select the checkbox next to the campus name, then click Rename Campus . A dialog box appears into which you enter the new name of the campus. Click OK to accept the new name, or click Cancel to exit this action.
Delete Campuses	Use this button to delete existing campuses in the list. To delete a campus, select the checkbox next to the building ID, then click Delete Campuses . You can only delete empty campuses. If you attempt to delete a campus that contains one or more buildings, an error message appears.
Export	Use this button to export a database file with all the specifications and background images of one or more selected campuses in the list. See "Exporting and Importing Files" on page 813.
Import	Use this button to import database files that define campuses into the RF Plan list. See "Exporting and Importing Files" on page 813.

Buttons	Description
AP FQLN Mapper	The AP name is a fully-qualified location name (FQLN) in the format <i>APname.floor.building.campus</i> (the <i>APname</i> portion of the FQLN must be unique). The FQLN is not case sensitive and supports a maximum of 249 characters, including spaces. You can use any combination of characters except a new line, carriage return, and non-printable control characters. You can manually set the FQLN for the AP by clicking the AP FQLN Mapper button. Setting the FQLN will reboot the APs. See " FQLN Mapper " on page 816

Building List Pane

Edit a campus from the building list pane.

Figure 364: *Plan>Building List Pane*

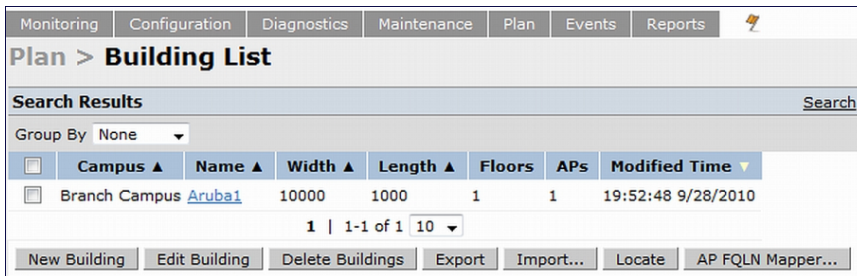

You can add, edit, and delete buildings using this page. You may also import and export building information. The buttons on this page are defined in [Table 365](#).

Table 365: *Building List Buttons*

Buttons	Description
New Building	Use this button to create a new building. When you add or edit a building, you can access other RF Plan pages.
Edit Building	Use this button to edit existing buildings in the building list. To edit a building, select the checkbox next to the building ID, then click Edit Building . When you add or edit a building, you can access other RF Plan pages.
Delete Buildings	Use this button to delete existing buildings in the building list. To delete a building, select the checkbox next to the building ID, then click Delete Building .
Export	Use this button to export a database file with all the specifications and background images of one or more selected buildings in the building list. See " Exporting and Importing Files " on page 813.
Import	Use this button to import database files that define buildings into the RF Plan building list. See " Exporting and Importing Files " on page 813.
Locate	Use this button to locate Wi-Fi devices in a building. See " Locate " on page 815.
AP FQLN Mapper	The AP name is a fully-qualified location name (FQLN) in the format <i>APname.floor.building.campus</i> (the <i>APname</i> portion of the FQLN must be unique). The FQLN is not case sensitive and supports a maximum of 249 characters, including spaces. You can use any combination of characters except a new line, carriage return, and non-printable control characters. You can manually set the FQLN for the AP by clicking the AP FQLN Mapper button. Setting the FQLN will reboot the APs. See " FQLN Mapper " on page 816.

Building Specifications Overview

The Building Specification Overview window displays the default values for a building that you are adding or the current values for a building that you are modifying.

Figure 366: *Plan>New Building>Overview Window*

The screenshot shows the 'AP Modeling Parameters' configuration window. The left sidebar has a tree view with 'Building Specification' selected. The main area is titled 'Plan > New Building 1 > AP Modeling Parameters'. It features an 'Edit' section with the following fields:

- Radio Type: 802.11a|b|g
- AP Type: 125
- Radio Mode: Coverage (selected), Capacity, Custom
- Overlap Factor: 150% Medium
- Total Users: 10
- Users / AP: 10
- 802.11b|g Desired Rate: 11 Mbps
- 802.11a Desired Rate: 54 Mbps
- 2.4 GHz 802.11n (HT) Support:
- 5 GHz 802.11n (HT) Support:
- 2.4 GHz 802.11n Desired Rate: 130 Mbps
- 5 GHz 802.11n Desired Rate: 130 Mbps
- 2.4 GHz 40 MHz Channel Spacing:
- 5 GHz 40 MHz Channel Spacing:

Summary statistics at the bottom:

- Number of required APs: 8
- Number of APs to support total users: 2
- Number of APs to meet desired rate: 8

An 'Apply' button is located at the bottom right.

The Overview page includes the following:

- Building Dimensions: Your building's name and dimensions
- Access Point Modeling Parameters
- Air Monitor Modeling Parameters
- **Building Dimension** button (in the upper right-hand portion of the page). Click on this button to edit the building dimensions settings.

When you create or edit information for a building, there are several ways you can navigate through RF Plan windows:

- The navigation pane on the left side of the browser window displays RF Plan pages in the order in which they should be accessed when you are creating a new building. If you are editing a building, simply click on the page you want to display or modify.
- A button for the next page appears in the upper right-hand portion of the page. You can click on this button to display the next page. For example, the **Building Dimension** button appears in the Building Specifications Overview page.
- Clicking **Apply** on editable pages sequences you to the next page. For example, when you click **Apply** in the Building Dimensions page, the AP Modeling Parameters page displays.

Building Dimension Page

The Building Dimension page allows you to specify the name and identification for the building and its dimensions. [Table 368](#) defines the parameters to insert in this window.

Figure 367: *Plan>New Building>Specification Window*

The screenshot shows the 'Specification' configuration window. The left sidebar has a tree view with 'Building Specification' selected. The main area is titled 'Plan > New Building 1 > Specification'. It features an 'Edit' section with the following fields:

- Campus Name: default
- Building Name: New Building 1
- Width: 200
- Length: 100
- Inter Floor Height: 30 Unit: feet
- Floors: 1

Buttons: 'Apply' and 'Save' (with a dropdown arrow).

[Table 368](#) contains the information for you to enter in the Specification window.

Table 368: New Building Specifications Parameters

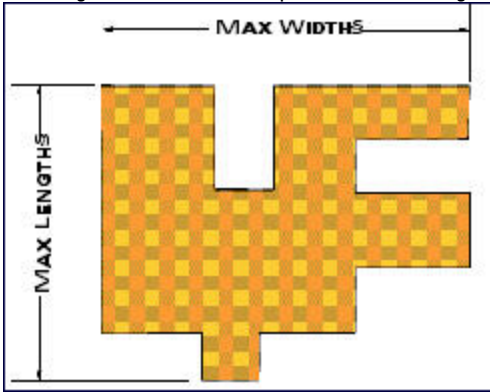
Parameter	Description
Campus Name	Select a campus for this building from the drop-down menu.
Building Name	The Building Name is an alphanumeric string up to 64 characters in length.
Width and Length	<p>Enter the rectangular exterior dimensions of the building. The valid range for this field is any integer from 1 to a value corresponding to 1x10,000. If your building has an irregular shape, the width and length should represent the maximum width and length of the overall footprint of the building as seen from above. For example:</p>  <p>When width and length are specified, RF Plan creates a rectangular area in the Planning feature pages that represent the overall area covered by the building. You need to import an appropriate background image (see "Floor Editor Dialog Box" on page 806.) to aid you in defining areas that do not require coverage or areas in which you do not wish to deploy APs and AMs (see "Area Editor Dialog Box" on page 807).</p>
Inter-Floor Height	<p>This is the distance between floor surfaces in the building. The valid range for this field is any integer from 1 to a value corresponding to 1x10,000. RF Plan uses the inter-floor height to allow APs on one floor to service users on adjacent floors. If you do not want RF Plan to factor adjacent floors, select a high inter-floor height value (for example, 300).</p> <p>NOTE: This is <i>not</i> the distance from floor to ceiling. Some buildings have a large space between the interior ceilings and the floor above.</p>
Floors	<p>Enter the number of floors in your building here. The valid range for this field is any integer from 1 to 255. A building can have a maximum of 255 floors. You can also configure negative floor IDs. Negative floor IDs let you allocate floors as sub floors, ground floors, basements or other underground floors, or floors where you do not need to deploy APs.</p> <p>You specify a negative integer when modifying an existing floor; you do not configure negative floor settings when adding a building or adding a floor. For more information, see "Level" on page 806.</p>
Unit	Specify the unit of measurement for the dimensions you specified on the page. The choices are feet and meters.

AP Modeling Parameters Page

The AP Modeling Parameters page allows you to specify the information necessary for RF Plan to determine the appropriate placement of your APs. These settings are on a per-building basis. If you have a mix of APs, choose the most common one to define the building parameters.

Figure 369: Plan>New Building>AP Modeling Parameters Window

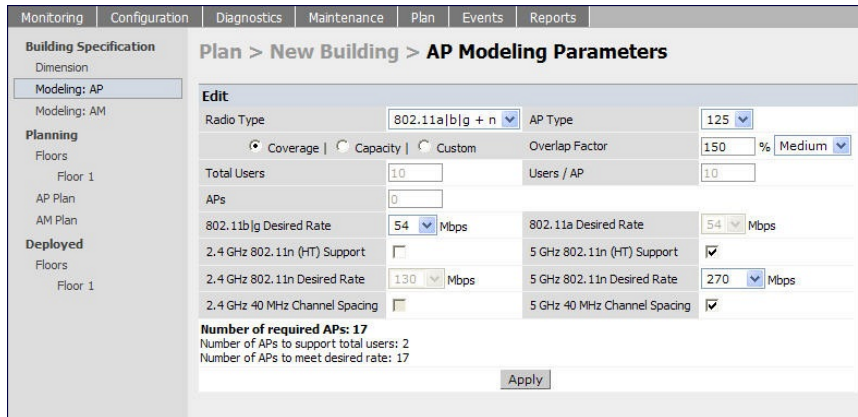

This window allows you to select or control the parameters as defined in [Table 370](#).

Table 370: AP Modeling Parameters

Parameter	Description
Radio Type	Use this drop-down menu to specify the radio type. See "Radio Type" on page 800
AP Type	Dell Alcatel AP device. Use the drop-down menu to select the device type. The supported APs listed in the drop-down menu are dependent on the selected radio type.
Design Model	Use the Coverage, Capacity, and Custom radio buttons to specify a design model to use in the placement of APs. See "Design Model" on page 801
Overlap Factor	Use this field and drop-down to specify an overlap factor. See "Overlap Factor" on page 801 .
Users	Use this field to specify the number of users on your WLAN. See "Users/AP" on page 802 .
Radio Properties (Desired Rates and HT Support Options)	Use this drop-down to define 802.11a, 802.11b/g, and 802.11n settings for the 5 GHz and 2.4 GHz frequency bands, including high-throughput, data rates, and 40 Mhz channel spacing. See "Radio Properties (Desired Rates and HT Support Options)" on page 802 .
APs	Use this field to enter the fixed number of APs to be used in this building's network (Custom model only).

Radio Type

Use the drop-down radio type menu to specify radio type of your AP. The available types are defined in [Table 371](#).

Table 371: Radio Type Definitions

Parameter	Description
801.11a/b/g	Simultaneous use of 802.11b/g and 802.11a.
802.11b/g	2.4 GHz, Direct Spread Spectrum (DSSS) multiplexing with data rates up to 11 Mbps, combined with Orthogonal Frequency Division Multiplexing/Complementary Code Keying (OFDM/CCK) with data rates up to 54 Mbps.

Parameter	Description
802.11a	5 GHz Orthogonal Frequency Division Multiplexing (OFDM) with data rates up to 54 Mbps.
802.11a/b/g + n	Mixed-mode radio type which allows for simultaneous use of 802.11b/g and 802.11n traffic on the 2.4 GHz frequency band, and 802.11a and 802.11n traffic on the 5 GHz frequency band.
802.11b/g + n	Mixed-mode radio type that allows for simultaneous use of 802.11b/g and 802.11n traffic on the 2.4 GHz frequency band.
802.11a + n	Mixed-mode radio type that allows for simultaneous use of 802.11a and 802.11n traffic on the 5 GHz frequency band.

Design Model

Three radio buttons, defined in [Table 372](#), allow you to control the kind of model used to determine the number and type of APs.

Table 372: *Design Model Radio Buttons*

Radio Button	Description
Coverage	Use this option to let RF Plan automatically determine the number of APs based on desired data rates and the configuration of your building. The higher the data rate, the smaller the coverage area, and the more APs that are required. Coverage is the most common type of installation.
Capacity	Use this option to let RF Plan determine the number of APs based on the total number of users, ratio of users to APs, and desired data rates. Capacity-based coverage is useful for high capacity conference or training rooms, where the APs could have a high volume of users.
Custom	Use this option to specify a fixed number of APs. Custom coverage is useful for deployments with a known number of APs or if you have a fixed project budget.

Overlap Factor

The Overlap Factor is the amount of signal area overlap when the APs are operating. Overlap is important if an AP fails as it allows the network to self-heal with adjacent APs powering up to assume some of the load from the failed device. Although there may be no holes in coverage in this scenario, there is likely to be a loss of throughput. Increasing the overlap allows for higher throughputs when an AP has failed and allows for future capacity as the number of users increases.

You can select a pre-determined value from the drop-down overlap menu or specify a value in the text box to the left of the drop-down. The following table describes the available options.

Table 373: *Overlap Factor Values*

Overlap Factor	Description
100% Low	Use this option for buildings that contain open spaces such as warehouses.

Overlap Factor	Description
150% Medium	Use this option for most typical office environments with cubicles and sheetrock walls that have higher WLAN user density than warehouses.
200% High	Use this option for dense deployments such as buildings with poor RF coverage characteristics including buildings with thick brick or concrete walls, lots of metal, or excess RF noise (for example, data centers).
Custom	Use this option to enter a custom rate. For most office spaces, 120% works well. When specifying the custom rate, the valid range is 1% to 1000%.

Users/AP



NOTE: The Users text boxes are active only when the Capacity model is selected.

Enter the number of users you expect to have on your WLAN in the Users text box. Enter the number of users per AP you expect in the Users/AP text box.

The numbers entered in these two text boxes must be non-zero integers between 1-255 inclusive.

Radio Properties (Desired Rates and HT Support Options)

Define 802.11a, 802.11b/g, and 802.11n settings for the 5 GHz and 2.4 GHz frequency bands, including high-throughput, data rates, and 40 Mhz channel spacing.

Table 374: *Radio Properties*

Radio Property	Description
802.11a Desired Rate	The desired 802.11a rate defines the estimated transmit rate within the WLAN coverage area. The higher the speed, the smaller the coverage area, and the more APs required. The valid values are: 54, 48, 36, 24, 18, 12, 9, 6. This option is only available when 802.11n (HT) support is disabled (unchecked or grayed out). When an 802.11n radio type, such as 802.11a + n or 802.11a/b/g + n, is selected and 802.11n (HT) support is enabled (checked) on the 5 GHz band, the system will automatically define the 802.11a rate. The system looks at the defined 802.11n rate and the distance covered by the defined rate; the system then selects a corresponding 802.11a rate based on the distance covered.
5 GHz 802.11 (HT) Support	High-throughput is available when utilizing the IEEE 802.11n standard and can be enabled on the 5 GHz frequency band when either the 802.11a + n or 802.11a/b/g + n mixed-mode radio type is selected. The 802.11n (high-throughput) draft standard supports MIMO (Multiple Input, Multiple Output) and the option of 40 MHz mode of operation. However, high-throughput can be utilized on a 20 MHz channel or on a 40 MHz channel (bonded channel pair).
5 GHz 802.11n Desired Rate	The desired 802.11n rate defines the estimated transmit rate within the WLAN coverage area. The higher the speed, the smaller the coverage area, and the more APs required. This option is only available when 802.11n (HT) support is enabled (checked). The valid values when using 20 MHz channel spacing: 6.5, 13.0, 19.5, 26.0, 39.0, 52.0, 58.5, 65.0, 78.0, 104.0, 117.0, 130.0. The valid values when using 40 MHz channel spacing: 13.5, 27.0, 40.5, 54.0, 81.0, 108.0, 121.15, 135.0, 162.0, 216.0, 243.0, 270.0.
5 GHz Use 40 MHz Channel	Use 40 MHz Channel Spacing —40 MHz operation, which supports higher data rates by

Radio Property	Description
Spacing	utilizing two 20 MHz channels as a bonded pair, requires that high-throughput be enabled (checked). 40 MHz mode is most often utilized on the 5 GHz frequency band due to a greater number of available channels. This option is only available when 802.11n (HT) support is enabled (checked).
802.11b/g Desired Rate	The desired 802.11b/g rate defines the estimated transmit rate within the WLAN coverage area. The higher the speed, the smaller the coverage area, and the more APs required. The valid values are: 54, 48, 36, 24, 18, 12, 9, 6, 11, 5.5, 2, 1. This option is only available when 802.11n (HT) support is disabled (unchecked or grayed out). When an 802.11n radio type, such as 802.11g + n or 802.11a/b/g + n, is selected and 802.11n (HT) support is enabled (checked) on the 2.4 GHz band, the system will automatically define the 802.11b/g rate. The system looks at the defined 802.11n rate and the distance covered by the defined rate; the system then selects a corresponding 802.11b/g rate based on the distance covered.
2.4 GHz 802.11 (HT) Support	High-throughput is available when utilizing the IEEE 802.11n standard and can be enabled on the 2.4 GHz frequency band when either the 802.11g + n or 802.11a/b/g + n mixed-mode radio type is selected. The 802.11n (high-throughput) draft standard supports MIMO (Multiple Input, Multiple Output) and the option of 40 MHz mode of operation. However, high-throughput can be utilized on a 20 MHz channel or on a 40 MHz channel (bonded channel pair).
2.4 GHz 802.11n Desired Rate	The desired 802.11n rate defines the estimated transmit rate within the WLAN coverage area. The higher the speed, the smaller the coverage area, and the more APs required. This option is only available when 802.11n (HT) support is enabled (checked). The valid values when using 20 MHz channel spacing: 6.5, 13.0, 19.5, 26.0, 39.0, 52.0, 58.5, 65.0, 78.0, 104.0, 117.0, 130.0. The valid values when using 40 MHz channel spacing: 13.5, 27.0, 40.5, 54.0, 81.0, 108.0, 121.15, 135.0, 162.0, 216.0, 243.0, 270.0.
2.4 GHz Use 40 MHz Channel Spacing	40 MHz operation, which supports higher data rates by utilizing two 20 MHz channels as a bonded pair, requires that high-throughput be enabled (checked). Due to a limited number of channels on the 2.4 GHz frequency band, 40 MHz mode is most often utilized on the 5 GHz frequency band where a greater number of channels are available. This option is only available when 802.11n (HT) support is enabled (checked).

AM Modeling Page

The AM Modeling page allows you to specify the information necessary for RF Plan to determine the appropriate placement of your AMs.



NOTE: AM coverage rates refer to the rate at which an AM captures packets. RF Plan uses that information to determine the placement of AMs.

Figure 375: AM Modeling Page

The screenshot shows the 'AM Modeling Parameters' configuration page. The breadcrumb trail is 'Plan > New Building 1 > AM Modeling Parameters'. The page has a left sidebar with navigation options: Building Specification (Dimension, Modeling: AP, Modeling: AM), Planning (Floors, Floor 1, AP Plan, AM Plan), and Deployed (Floors, Floor 1). The main content area is titled 'Edit' and contains the following settings:

- Radio Type: Coverage (selected) or Custom
- 802.11b/g Monitor Rate: 5.5 Mbps
- 802.11a Monitor Rate: 36 Mbps
- AMs: 0
- Number of required AMs: 3

Buttons for 'Save', 'Planning >', and 'Apply' are visible.

Controls on this page allow you to select the following functions, which are described in more detail in this section:

Table 376: *AM Modeling Radio Buttons*

Radio Button	Description
Design Model	Use these radio buttons to specify a design model to use in the placement of AMs. See " Design Models " on page 804.
Monitor Rates	Use this drop-down menu to specify the desired monitor rate for the AMs. See " Monitor Rates " on page 804.
AMs	Use this field to manually specify the number of AMs to deploy (Custom Model only).

Design Models

Two radio buttons on the page allow you to specify the model used to determine the number and type of APs.

Table 377: *Design Model Radio Buttons*

Radio Button	Description
Coverage	Use this option to let RF Plan automatically determine the number of AMs based on desired monitor rates and the configuration of the building. Desired rate is selectable from 1 to 54 Mbps in the Coverage model.
Custom	Use this option to specify a fixed number of AMs. When the AM Plan portion of RF Plan is executed, RF Plan distributes the AMs evenly.

 NOTE: The monitor rates you select for the AMs should be less than the data rates you selected for the APs. If you set the rate for the AMs at a value equal to that specified for the corresponding PHY type AP, RF Plan allocates one AM per AP. If you specify a monitor rate greater than the data rate, RF Plan allocates more than one AM per AP.

Monitor Rates

Use the drop down menus to select the desired monitor rates for the 2.4 GHz (802.11b/g) and 5 GHz (802.11a) frequency bands. The available monitor rates that display in drop-down lists will vary: these rates are dependent on the radio type selected on AP modeling page and they will also be adjusted to accommodate for 20 MHz vs. 40 MHz channel spacing when 802.11n (HT) support is enabled.

 NOTE: This option is available only when the coverage design model is selected.

Planning Floors Page

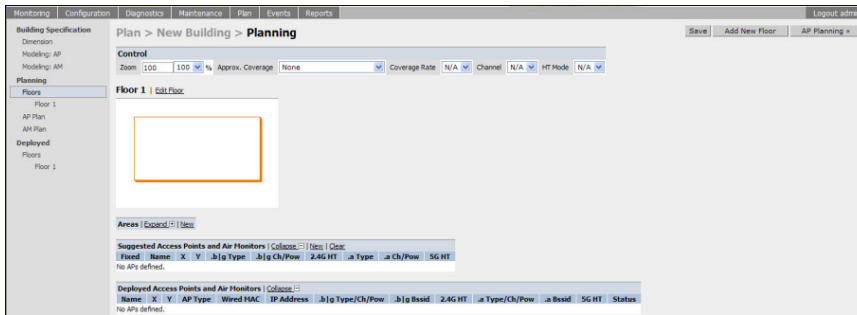

The Planning Floors page enables you to see the footprint of your floors.

Figure 378: Planning Floors Page



You can select or adjust the features as described in [Table 379](#):

Table 379: Floor Planning Features

Feature	Description
Zoom	Use this drop-down menu or type a zoom factor in the text field to increase or decrease the size of the displayed floor area. See "Zoom" on page 805.
Approximate Coverage Map (select radio type)	Use this drop-down to select a particular radio type for which to show estimated coverage. See "Approximate Coverage Map" on page 806.
Edit Floor	Click on this link to launch the Floor Editor dialog box. See "Floor Editor Dialog Box" on page 806.
New in Areas section	Click on this link to launch the Area Editor dialog box. See "Area Editor Dialog Box" on page 807.
New in Suggested Access Points and Air Monitors section	Click on this link to launch the Suggested Access Point Editor dialog box. See "Access Point Editor Dialog Box" on page 809.
Status in Deployed Access Points and Air Monitors section	The Status column displays the status of each AP for the floor you are viewing within a live network. Up: AP is up (live). The corresponding AP icon on the floor map will display a live AP icon.  Down: AP is down. The corresponding AP icon on the floor map will display with a red "X" over the AP icon symbolizing that the AP is down. 

Zoom

The Zoom control sets the viewing size of the floor image. It is adjustable in finite views from 10% to 1000%. You may select a value from the drop-down zoom menu or specify a value in the text box to the left of the drop-down. When you specify a value, RF Plan adjusts the values in the drop-down to display a set of values both above and below the value you typed in the text box.

Approximate Coverage Map

Select a radio type from the Coverage drop-down menu to view the approximate coverage area for each of the APs that RF Plan has deployed in AP Plan or AM Plan. Adjusting the coverage values help you to understand how the AP coverage works in your building.



NOTE: You will not see coverage areas displayed here until you have executed either an AP Plan or an AM Plan.

Figure 380: Coverage Map Example



Floor Editor Dialog Box

The Floor Editor dialog box allows you to modify the floor level, specify the background image, and name the floor. The Floor Editor is accessible from the Floors Page by clicking on the **Edit Floor** link.

Figure 381: Floor Editor Dialog Box

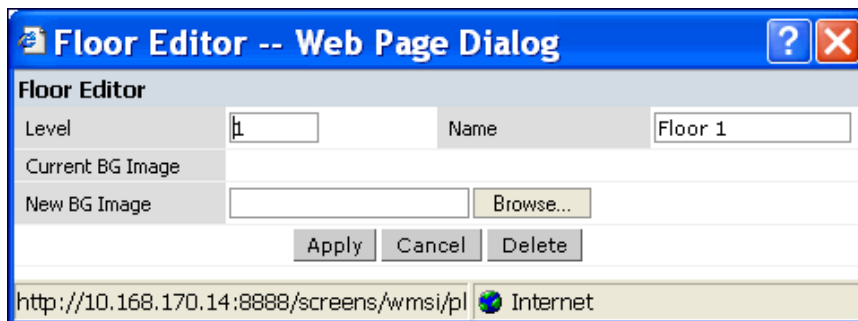

Level

When modifying an existing floor, you can configure it with a negative integer to specify a basement or some other underground floor that you do not need or want to deploy APs.

To configure a negative floor, specify a negative integer in the Level field. The valid range is -100 to 255; however, a building can have a maximum of 255 floors.

Naming

You may name the floor anything you choose as long as the name is an alphanumeric string with a maximum length of 64 characters. The name you specify appears to the right of the Floor Number displayed above the background image in the Planning view.

Background Images

You can import a background image (floor plan image) into RF Plan for each floor. A background image is extremely helpful when specifying areas where coverage is not desired or areas where an AP/AM is not to be physically deployed.

Use the guidelines in this section when importing background images. By becoming familiar with these guidelines, you can ensure that your graphic file is edited properly for pre- and post-deployment planning.

- Edit the image—Use an appropriate graphics editor to edit the file as needed.
- Scale the image—If the image is not scaled, proportional triangulation and heat map displays can be incorrect when the plan is deployed.
- Calculate image dimensions—Calculate the image pixels per feet (or meters) against a known dimension. Use that value to calculate the width and length of the image.
- Leave a border around the image—When creating the image, leave a boarder around the image to help triangulate Wi-Fi devices outside of the building.
- Multiple floors—If your building has multiple floors, make sure there is a common anchor point for all floors; for example an elevator shaft, a staircase, and so on.
- Larger dimensions—Use larger dimensions only for scaling to more accurately calculate the full dimensions. For best results, final floor images 2048 X 2048 and smaller perform best.

Select a background image using the Browse button on the Floor Editor dialog box.

- File Type and Size

Background images must be JPEG format and may not exceed 2048 X 2048 pixels in size. Attempting to import a file with a larger pixel footprint than that specified here results in the image not scaling to fit the image area in the floor display area.

Because background images for your floors are embedded in the XML file that defines your building, you should strongly consider minimizing the file size of the JPEGs that you use for your backgrounds. You can minimize the file size by selecting the maximum compression (lowest quality) in most graphics programs.

 NOTE: The ArubaOS WebUI displays floor plans using Adobe Flash Player, which does not support progressive JPEG images. If you have a progressive JPEG image you want to use as background image, open the image in an image editing program and re-save the image with standard/baseline compression.

- Image Scaling

Images are scaled (stretched) to fit the display area. The display area aspect ratio is determined by the building dimensions specified on the Dimension page.

Area Editor Dialog Box

The Area Editor dialog box allows you to specify areas on your building floors where you either do not care about coverage, or where you do not want to place an AP or AM.

Open the Area Editor dialog box by clicking **New** in the Areas section.

You specify these areas by placing them on top of the background image using the Area Editor.

Figure 382: Area Editor Dialog Box

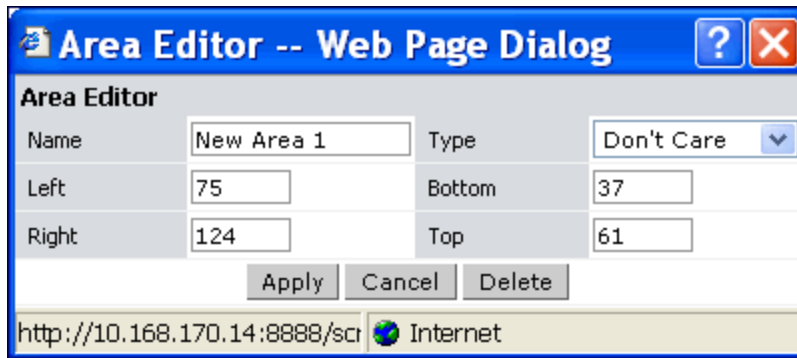

Naming

Logical name of area, as an alphanumeric string consisting of 1 to 64 characters. Dell recommends that you provide a meaningful name to the area to ensure that it is readily identifiable.

Location and Dimensions

Specify absolute coordinates for the lower left corner and upper right corner of the box that represents the area being defined.

- Begin the measurement with the lower left corner of the rectangular display area that represents your building's footprint.
- The coordinates of the upper right-hand corner of the display area are the absolute values of the dimensions you provided for the building.

Location settings are zero-based. Values range from 0 to (height -1 and width -1). For example, coordinates of the upper right corner for a building that measures 200 ft. wide x 400 ft. in length, would be 199 and 399.



NOTE: The unit of measurement displayed as either feet or meters is based on your building settings. See "[Building Dimension Page](#)" on page 798 for details about configuring building parameters.

You may also use the drag and drop feature of the Area Editor to drag your area to where you want it and resize it by dragging one or more of the handles displayed in the corners of the area.

Area Types

Figure 383: Area Types

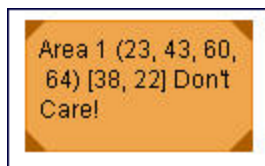

Select one of the area types from the drop-down menu: Don't Care, Don't Deploy, or 802.11n Zone.

- **Don't Care:** Coverage is not required in the area specified in this dialog box. This specification typically applies to areas where coverage cannot be guaranteed.
This setting results in the display of an orange rectangle at the associated area in the floor diagram.
- **Don't Deploy:** No APs are to be positioned in the area specified in this dialog box.
This setting results in display of a yellow rectangle at the associated area in the floor diagram.

- **802.11n Zone:** 802.11n compliant APs are required to be positioned in the area specified in this dialog box only.

This setting results in display of a green rectangle at the associated area in the floor diagram.

You cannot right-click within an existing area to add another area inside of it. For instance, if a Don't Care or Don't Deploy Area needs to overlap with an 802.11n Zone, you must create each of the areas outside of one another and then move them to the correct position of overlap. You can click and drag the areas to the appropriate positions of overlap, or you can right-click on the area to modify its location.

Access Point Editor Dialog Box

The Access Point Editor allows you to manually create or modify a suggested AP.

To create an AP, open the Access Point Editor dialog box by clicking **New** in the Suggested Access Points and Air Monitors section.

To modify an existing AP, place the cursor over the AP and click it to display the Suggested Access Point Editor dialog box.

Figure 384: Access Point Editor

Name		AP 11	Floor Name		Floor 1
Fixed	No	Radio	802.11a b g		
X	100	Y	50		
802.11b g Type	Access Point	802.11b g Channel	1	802.11b g Power Level	14.0 dBm
2.4 GHz 802.11n (HT) Support	<input type="checkbox"/>	Use 2.4 GHz 40 MHz Channel	<input type="checkbox"/>		
802.11a Type	Access Point	802.11a Channel	36	802.11a Power Level	14.0 dBm
5 GHz 802.11n (HT) Support	<input type="checkbox"/>	Use 5 GHz 40 MHz Channel Pair	<input type="checkbox"/>		
Memo	<input type="text"/>				
<input type="button" value="Apply"/> <input type="button" value="Cancel"/> <input type="button" value="Delete"/>					

Naming

RF Plan automatically names APs using the default convention *ap number*, where *number* starts at 1 and increments by one for each new AP. When you manually create an AP, the new AP is assigned the next number and is added to the bottom of the suggested AP list.

You may name an AP anything you wish. The name must consist of alphanumeric characters and be 64 characters or less in length.

Fixed

Fixed APs do not move when RF Plan executes the positioning algorithm.



NOTE: You might typically set a fixed AP when you have a specific room, such as a conference room, in which you want saturated coverage. You might also want to consider using a fixed AP when you have an area that has an unusually high user density.

Choose Yes or No from the drop-down menu. Choosing Yes locks the position of the AP as it is shown in the coordinate boxes of the Access Editor. Choosing No allows RF Plan to move the AP as necessary to achieve best performance.

Radio Types

The Radio drop-down menu allows you to specify what frequency band the AP uses. You can choose from one of the following:

- 802.11a/b/g (2.4 GHz and 5 GHz frequency bands)
- 802.11a (5 GHz frequency band)
- 802.11 b/g (2.4 GHz frequency band)

NOTE: 802.11n (HT) support features are available on the 2.4 or 5 GHz frequency band. The availability of these options on these frequency bands is dependent on the radio (frequency band) chosen and whether or not these feature were enabled on the AP modeling page at the building level.

X and Y Coordinates

The physical location of the AP is specified by X-Y coordinates that begin at the lower left corner of the display area. The numbers you specify in the X and Y text boxes are whole units. The Y-coordinate increases as a point moves up the display and the X-coordinate increases as they move from left to right across the display.

Figure 385: *Physical Location of AP*

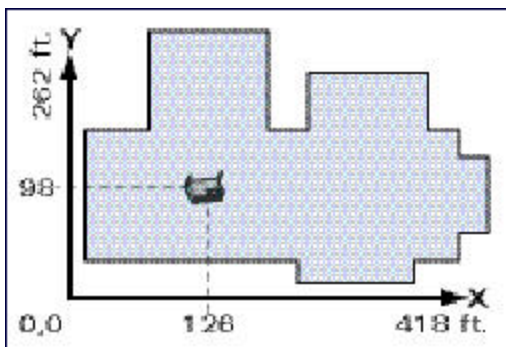

802.11 Types

The 802.11 b/g and 802.11a Type drop-down menus allow you to choose the mode of operation for the AP. You may choose to set the mode of operation to Access Point or Air Monitor.

802.11 Channels

The 802.11a and 802.11b/g channel drop-down menus allow you to select from the available channels.

NOTE: The available channels vary depending on the regulatory domain (country) in which the device is being operated.

802.11 Power Levels

The power level drop-down menus allow you to specify the transmission power of the AP. Choices are OFF, 0, 1, 2, 3, and 4. A setting of 4 applies the maximum Effective Isotropic Radiated Power (EIRP) allowed in the regulatory domain (country) in which you are operating the AP.

802.11n Features

- **802.11n (HT) Support (2.4 or 5 GHz):** Specify if 802.11n high-throughput support should be enabled on this AP.

In order to enable high-throughput on a new AP being added to the plan at the floor level, 802.11n (HT) support must first be enabled at the building level within the AP modeling parameters. If not, this option will be grayed out. See ["AP Modeling Parameters Page" on page 799](#) for details about AP modeling parameters.

- **Use 40 MHz Channel (2.4 or 5 GHz):** Specify if 802.11n high-throughput support should utilize a 40 MHz channel (bonded channel pair).

In order to select a valid 40 MHz channel for a new AP being added at the floor level, use of 40 MHz channel spacing must first be enabled at the building level within the AP modeling parameters. If not, this option will be grayed out. See ["AP Modeling Parameters Page" on page 799](#) for details about AP modeling parameters.

If high-throughput is enabled and use of a 40 MHz channel pair is not enabled, a 20 Mhz channel will be utilized.

Memo

The Memo text field allows you to enter notes regarding the AP. You can enter a maximum of 256 alphanumeric characters in the Memo field.

AP Plan Page

The AP Plan page uses the information entered in the modeling pages to locate APs in the building(s) you described. All of the options on the Floors page can also be viewed and configured on the AP Plan page. The AP Plan page also includes some additional options, such as initializing, optimizing, and fixing AP/AM locations.

Figure 386: AP Planning

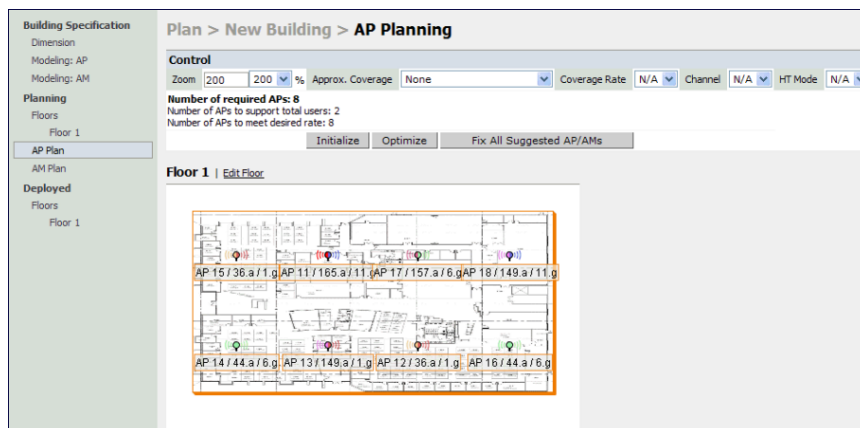

Initialize

Initialize the Algorithm by clicking the **Initialize** button. This makes an initial placement of the APs and prepares RF Plan for the task of determining the optimum location for each of the APs. As soon as you click **Initialize** you see the AP symbols appear on the floor plan.

Colored circles around the AP symbols on the floor plan indicate the approximate coverage of the individual AP and the color of the circle represents the channel on which the AP is operating. The circles appear when you select an *approximate coverage* value on one of the Floors pages. You may also click an AP icon and drag it to manually reposition it.

Optimize

Click **Optimize** to launch the optimizing algorithm. The AP symbols move on the page as RF Plan finds the optimum location for each.

The process may take several minutes. You may watch the progress on the status bar of your browser. The algorithm stops when the movement is less than a threshold value calculated based on the number of APs. The threshold value may be seen in the status bar at the bottom of the browser window.

Viewing the Results

The results of optimizing algorithm may be viewed two ways: graphically and in a table of suggested APs. You may obtain information about a specific AP by placing the cursor over its symbol. An information box appears that contains information regarding location, radio type, high-throughput support, channel(s), and power.

Figure 387: Results

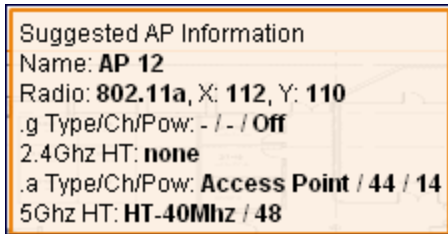

The Suggested Access Points and Air Monitors table lists the coordinates, power, location, power setting, high-throughput support, and channel(s) for each of the APs that are shown in the floor plan.

Figure 388: Suggested APs and Air Monitors Table

Suggested Access Points and Air Monitors Collapse <input type="checkbox"/> New Clear										
Fixed	Name	X	Y	.b g Type	.b g Ch/Pow	2.4G HT	.a Type	.a Ch/Pow	5G HT	
No	AP 11	151	76	-	- / -	-	Access Point 36 / 14		40Mhz/40	
No	AP 12	77	125	-	- / -	-	Access Point 44 / 14		40Mhz/48	
No	AP 13	225	26	-	- / -	-	Access Point 44 / 14		40Mhz/48	
No	AP 14	75	25	-	- / -	-	Access Point 157 / 14		40Mhz/161	
No	AP 15	227	126	-	- / -	-	Access Point 157 / 14		40Mhz/161	
No	AP 16	51	75	-	- / -	-	Access Point 149 / 14		40Mhz/153	
No	AP 17	251	77	-	- / -	-	Access Point 149 / 14		40Mhz/153	

Fix All Suggested AP/AMs

Fix existing AP/AM locations at the building level. If AP/AM locations are fixed, AP/AMs will not move from their fixed locations during initialization or optimization. Clicking on this button will fix the locations of existing APs and AMs. You only need to click this button on either the AP or AM Plan page.

AM Plan Page

The AM Plan page uses the information entered in the modeling pages to locate AMs in the building(s) you described and calculate the optimum placement for the AMs. All of the options on the Floors page can also be viewed and configured on the AM Plan page. The AM Plan page also includes some additional options, such as initializing, optimizing, and fixing AP/AM locations.

Initialize

Initialize the Algorithm by clicking **Initialize**. This makes an initial placement of the AMs and prepares RF Plan for the task of determining the optimum location for each of the AMs. When you click **Initialize**, the AM symbols appear on the floor plan.

Optimize

Click **Optimize** to launch the optimizing algorithm. The AM symbols move on the page as RF Plan finds the optimum location for each.

The process may take several minutes. You may watch the progress on the status bar of your browser. The algorithm stops when the movement is less than a threshold value calculated based on the number of AMs. The threshold value may be seen in the status bar at the bottom of the browser window.

Viewing the Results

Viewing the results of the AM Plan feature is similar to that for the AP Plan feature.

The results of optimizing algorithm may be viewed two ways: graphically and in a table of suggested AMs. You may obtain information about a specific AM by placing the cursor over its symbol. An information box appears that contains information about the exact location, PHY type, high-throughput-support, channel, power, and so on.

Figure 389: Results

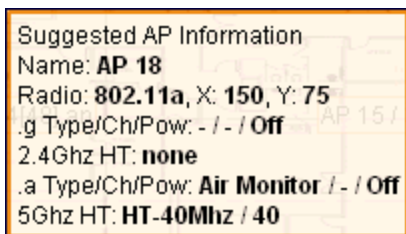

The Suggested Access Points and Air Monitors table lists the coordinates, power, location, power setting, and channel for each of the AMs that are shown in the floor plan.

Figure 390: Suggested APs and Air Monitors Table

Fixed	Name	X	Y	.b g Type	.b g Ch/Pow	2.4G HT	.a Type	.a Ch/Pow	5G HT
No	AP 18	150	75	-	- / -	-	Air Monitor	- / -	-

Fix All Suggested AP/AMs

Fix existing AP/AM locations at the building level. If AP/AM locations are fixed, AP/AMs will not move from their fixed locations during initialization or optimization. Clicking on this button will fix the locations of existing APs and AMs. You only need to click this button on either the AP or AM Plan page.

Exporting and Importing Files

Both the Campus List page and the Building List page have **Export** and **Import** buttons, which allow you to export and import files that define the parameters of your campus and buildings. You can export a file so that it may be imported into and used to automatically configure a controller. On a controller, you can import a file that has been exported from another controller or from the standalone version of RF Plan that runs as a Windows application.



NOTE: The WebUI version of RF Plan only supports JPEG file formats for background images.

The files that you export and import are XML files and, depending on how many buildings are in your campus, floors are in your buildings, and how many background images you have for your floors, the XML files may be quite large. (See "[Background Images](#)" on page 807.)



NOTE: In order for the WebUI RF Plan tool to import and read a standalone plan that incorporates 802.11n standard APs and was originally created in the Java-based standalone RF Plan tool, the plan must be exported out from the standalone tool using the Controller WebUI Format (version 3.0).

Export Campus

To export a file that defines the parameters of one or more campuses, including all of its associated buildings, select the campus(es) to be exported in the Campus List page and then click **Export**.

After you click the Export button, you are prompted to include the background images.

Figure 391: *Export Campus Confirmation Dialog Box*

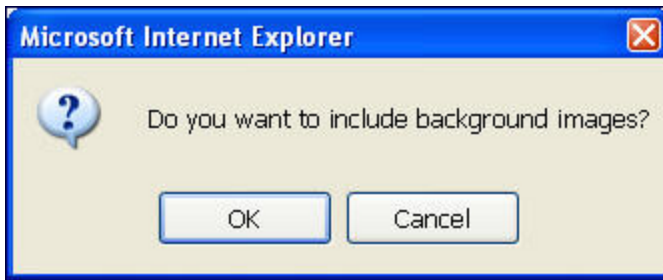

When exporting a campus file, Dell recommends that you click **OK** to export the background images. If you click **Cancel**, the exported file does not include the background images. The **File Download** window appears.

From the File Download window, click **Save** to save the file. The **Save As** dialog box appears. From here, navigate to the location where you want to save the file and enter the name for the exported file. When naming your exported file, be sure to give the file the **.XML** file extension, for example, *My_Campus.XML*.

Exported campus files include detailed information about the campus and the selected building(s).

Import Campus

You can import only XML files exported from another controller or from the standalone version of RF Plan that runs as a Windows application.



NOTE: Importing any other file, including XML files from other applications, may result in unpredictable results.

To import a file that defines the building parameters of one or more campuses, click the **Import** button in the Campus List page. The Import Buildings page appears, as described in "[Import Buildings Page](#)" on page 815.

Export Buildings Page

To export a file that defines the parameters of one or more buildings, select the building(s) to be exported in the Building List page and then click **Export**.

After you click the Export button, you are prompted to include the background images.

Figure 392: *Export Buildings Confirmation Dialog Box*

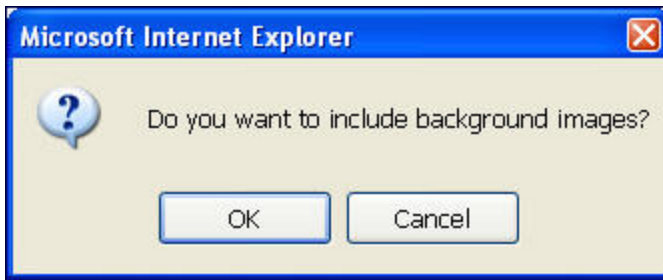

When exporting a building file, Dell recommends that you click **OK** to export the background images. If you click **Cancel**, the exported file does not include the background images. The **File Download** window appears.

From the File Download window, click **Save** to save the file. The **Save As** dialog box appears. From here, navigate to the location where you want to save the file and enter the name for the exported file. When naming your exported file, be sure to give the file the **.XML** file extension, for example, *My_Building.XML*.

Exported building files include the name of the campus to which the building belongs; however, detailed campus parameters are not included.

Import Buildings Page

You can import only XML files exported from another controller or from the standalone version of RF Plan that runs as a Windows application.



NOTE: Importing any other file, including XML files from other applications, may result in unpredictable results.

To import a file that defines the parameters of one or more buildings, click the **Import** button in the Building List page.

Figure 393: *Buildings List Page*



In the Import Buildings page, click **Browse** to select the file to be imported, then click the **Import** button.

Locate

The **Locate** button on the Building List page allows you to search for APs, AMs, monitored clients, etc. on a building by building basis. To use this feature, select the building in which you want to search, and click **Locate**.

The Target Devices table displays information on each of these devices. To add a device, click **Add Device**. To delete a device, click **Remove Device**. To select a device, click **Choose Devices**.

FQLN Mapper

Both the Campus List page and the Building List page have the **AP FQLN Mapper** button, which allows you to create a fully-qualified location name (FQLN) for the specified AP/AM in the format *APname.Floor.Building.Campus*.

The FQLN is not case sensitive and supports a maximum of 249 characters, including spaces. You can use any combination of characters except a new line, carriage return, and non-printable control characters.

You can use the FQLN mapper for multiple purposes, including:

- Searching for deployed APs/AMs
- Configuring the AP name in the form APname.Floor.Building.Campus
- Modifying the location of APs

To use this feature, select one or more campuses from the Campus List page, or one or more buildings from the Building List page, and click **AP FQLN Mapper**.

The AP FQLN Mapper page appears. From here, you can search for deployed APs by entering one or more parameters in the Search fields, view the results in the Search Results table, configure the FQLN, and modify the location of an AP.

To search for deployed APs, enter information in the Search fields and click **Search**.

Figure 394: AP FQLN Mapper

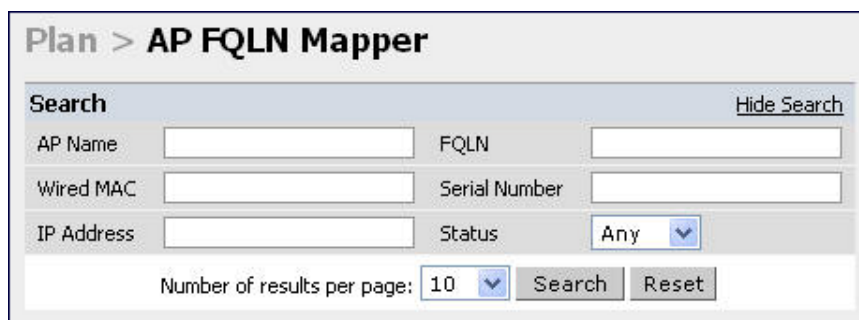

You can perform a search based on one or more of the following AP properties:

Table 395: AP Property Search

Property	Description
AP Name	Logical name of the AP or AM. You can enter a portion of the name to widen the search.
Wired MAC	MAC address of the AP or AM. You can enter a portion of the MAC address to widen the search.
IP Address	IP address of the AP or AM. You can enter a portion of the IP address to widen the search.
FQLN	Fully-qualified location name of the AP, in the form APname.floor.building.campus. You can enter a portion of the FQLN to widen the search.
Serial Number	Serial number of the AP. You can enter a portion of the serial number to widen the search.
Status	Current state of the AP, including Up/Down/Any.

Use the drop-down list to the right of the Number of results per page to specify the number of APs to display in the search results.

After entering the search criteria, you can either click **Reset** to clear the entries or click **Search** to search for APs. If you click **Search**, the results are displayed in the Search Result table:

Figure 396: Search Results Page

AP Name	Wired MAC	Serial #	AP Type	IP Address	FQLN	Status	Last Update Time
1.1.1	00:0b:86:c0:cf:d8	A90006272	65	3.3.3.10		down	13:21:40 10/25/2006

Campus: Main Campus Building: building 1 Floor: Floor 1 Set FQLN

You can view the information in ascending or descending order. By default, the display is in ascending order, based on the AP name (the white arrow indicates the row that is being used to sort the information). Left-click on a column head to view the information in ascending or descending order (you may need to click multiple times to get the desired display).

In addition to displaying AP names, wired MAC addresses, serial numbers, IP addresses, FQLNs, and AP status, the Search Result table displays the AP type and when it was last updating.

From here you can modify the attributes that create the FQLN for the selected AP, using the following drop-down lists:

- **Campus**—Displays the campus where the AP is deployed. To deploy the AP in a different campus, select a campus from the drop-down list. The Campus defines the buildings and floors displayed.



NOTE: This drop-down list only displays the existing campuses that you are managing. To add a new campus, see "[Campus List Page](#)" on page 796.

- **Building**—Displays the building where the AP is deployed. To deploy the AP in a different building, select a building from the drop-down list.



NOTE: This drop-down list only displays the available buildings in the selected campus. To add a new building, see "[Building List Pane](#)" on page 797.

- **Floor**—Displays the floor where the AP is deployed. To deploy the AP on a different floor, select a floor from the drop-down list.



NOTE: This drop-down lists only displays the available floors in the selected building. To add a new floor, see "[Planning Floors Page](#)" on page 804.

To submit your changes, click **Set FQLN**. Setting the FQLN reboots the APs.

Using the FQLN Mapper in the AP Provision Page

The AP Provision page (available from **Configuration > Wireless > AP Installation**) allows you to set an FQLN during the AP provisioning process.

Scroll to the FQLN Mapper near the bottom of the AP Provision page to modify the following attributes that create the FQLN:

- Campus
- Building

- Floor

The AP name appears in the AP List at the bottom of the page and will be used when provisioning the AP. To rename an AP, enter the new name in the AP Name field.

To retain the old FQLN value when reprovisioning an AP, do not select the Overwrite FQLN checkbox. However, if you configure new values for the campus, building, and floor settings, the FQLN value is changed, even if the Overwrite FQLN checkbox is selected. To remove a previously configured value, you can select N/A for a specific attribute.

If you provision more than one AP, the selected value for the campus, building, and floor is based on the first selected AP and applies to all APs. Only the AP name will be different as each AP must have a unique name.

Using the WebUI

1. Navigate to the **Configuration > Wireless > AP Installation** page. The list of discovered APs appears in the page.
2. Select the AP you want to set an FQLN, and click **Provision**.
3. Modify the FQLN attributes:
 - In the Provisioning page, scroll to the FQLN Mapper near the bottom of the page and modify the campus, building, and floor attributes.
 - Optionally, if you want rename an AP, scroll to the AP List at the bottom of the page and enter the new name in the AP Name field. For more information about AP names, see [Access Points \(APs\) on page 393](#)
4. Click **Apply and Reboot**.

Using the CLI

Reprovisioning the AP causes it to automatically reboot. When configuring the FQLN, you may also provision other AP settings.

The following example assumes you are not renaming an AP. For more information about AP names, see [Access Points \(APs\) on page 393](#).

```
provision-ap
  read-bootinfo ap-name <name>
  copy-provisioning-params ap-name <name>
  fqln <name>
  reprovision ap-name <name>
```

RF Plan Example

This section guides you through the process of creating a building and populating it with APs and AMs using RF Plan. Ensure you have sample .JPEG floor images handy for walking through this planning example.

Sample Building

[Table 397](#) lists the information to be used in this coverage-based planning example.

Table 397: Sample Building

Building Dimensions
Height: 100

Building Dimensions
Width: 100
Number of Floors: 2
User Information
Number of Users: N/A
Users per AP: N/A
Radio Types: 802.11a/b/g/n
AP Type: AP-93
Overlap Factor: 150% (Medium)
AP Desired Rates (5 GHz Radio Properties)
802.11a Desired Rate: 48 Mbps
802.11n (HT) Support: N/A
Use 40 MHz Channel Spacing: N/A
802.11n Desired Rate: N/A
AP Desired Rates (2.4 GHz Radio Properties)
802.11b/g Desired Rate: 48 Mbps
802.11n (HT) Support: N/A
Use 40 MHz Channel Spacing: N/A
802.11n Desired Rate: N/A
AM Desired Rates
802.11b g: 24 Mbps
802.11a: 24 Mbps
Don't Care/Don't Deploy Areas
Shipping & Receiving = Don't CareLobby = Don't Deploy
802.11n Hotspot (Zone) Areas
N/A

Create a Building

In this section you create a building using the information supplied in the planning table.

1. In the Campus List, select **New Campus**. Enter: **My Campus** and click **OK**.
2. In the Campus List, select the checkbox next to **My Campus**, and click **Browse Campus**.
3. Click **New Building**. The Overview page appears.

4. Click **Save**. A dialog box appears that indicates the new building was saved successfully. Click **OK** to close the dialog box.
5. Click **Building Dimension**. The Specification page appears.
6. Enter the following information in the text boxes.

Table 398: Create a Building

Text Box	Information
Campus Name	My Campus (The name is automatically populated based on what you entered in step 1 on page 819)
Building Name	My Building
Width	100
Length	100
Inter Floor Height	20
Units	Feet
Floors	2

7. Click **Save**. A dialog box appears that asks if you want to save and reload this building now since the building name was changed. Click **OK** to accept.
Another dialog box appears stating that the building was saved successfully. Click **OK** to close the dialog box.
8. Click **Apply**. RF Plan returns you to the Overview page.

Model the Access Points

You now determine how many APs are required to cover your building with a specified data transfer rate and overlap.

In this example, you use the Coverage Model. The following are assumed about the performance of the WLAN:

- Radio Types: 802.11a/b/g/n
 - AP Type: AP-93
 - Overlap factor: Medium (150%)
 - 802.11a desired rate: 48 Mbps
 - 802.11b desired rate: 48 Mbps
1. From the navigation tree, Click on **Modeling:AP** under Building Specification. The AP Modeling Parameters page appears.
 2. Select **801.11 a|b|g|n** from the Radio Type drop-down menu.
 3. Select **Medium** from the Overlap Factor drop-down menu.
 4. Notice that the percentage show at the left of the drop-down menu changes to 150%.
 5. Select **48** from the 802.11 b|g Desired Rate drop-down menu.
 6. Select **48** from the 801.11 a Desired Rate drop-down menu.
 7. Click **Save**, then **OK**.
 8. Click **Apply**. RF Plan moves to the AM Modeling Parameters page.

Model the Air Monitors

You now determine how many AMs are required to provide a specified monitoring rate. In this example you continue to use the Coverage Model and make the following assumptions:

- 802.11 b|g monitor rate: 24 Mbps
 - 802.11 a monitor rate: 24 Mbps
1. Select **24** from the 802.11 b|g Monitor Rate drop-down menu.
 2. Select **24** from the 802.11 a Monitor Rate drop-down menu.
 3. Click **Save**, then **OK**.
 4. Click **Apply**. RF Plan moves to the Planning page.

Add and Edit a Floor

You now add floor plans to your floors. In this section you:

- Add a background image floor plan for each floor
- Name the floors



NOTE: The information in this section assumes that you have a JPEG file that you can use as a sample background image when re-creating the steps.

Adding the background image and naming the first floor

1. In the Planning page, click the **Edit Floor** link at the right of the Floor 1 indicator. The Floor Editor dialog box appears.
2. Enter: **Entrance Level** in the **Name** box of the **Floor Editor Dialog**.
3. Use the **Browse** button to locate the background image for the 1st floor.
4. Click **Apply**.

Adding the background image and naming the second floor

1. Click the **Edit Floor** link at the right of the Floor 2 indicator.
2. Enter: **Second Level** in the **Name** box of the **Floor Editor Dialog**.
3. Use the **Browse** button to locate the background image for the 2nd floor.
4. Click **Apply**.
5. Click **Save** on the Planning page, then **OK**.

Defining Areas

Before you advance to the AP and AM Planning pages, define special areas, such as Don't Care, Don't Deploy, or 802.11n Zone. This example includes a Don't Care and a Don't Deploy Area.

This example assumes the following:

- We do not care if we have coverage in the Shipping and Receiving Area
- We do not want to deploy APs or AMs in the Lobby Area

Creating a Don't Care Area



NOTE: You can zoom in on the floor plan using the Zoom drop-down near the top of the AP Planning page, or type a zoom

value in the text box at the left of the drop-down and press the enter key on your keyboard. For example, enter a zoom factor of 400.

1. In the Planning page, click the **New** link in the Areas section under Floor 1 (named Entrance Level).
This opens the Area Editor.
2. Enter: **Shipping and Receiving** in the **Name** text box in the Area Editor.
3. Select **Don't Care** from the **Type** drop-down menu box.
4. Click **Apply**.
Notice that an orange box appears near the center of the floor plan.
5. Use your mouse (or other pointing device) to place the cursor over the box.
Notice that the information you typed in the editor appears in the box. You see the name and type of area, as well as the coordinates of the lower left corner and upper right corner of the box.



NOTE: The $x = 0$ and $y = 0$ coordinates correspond to the lower left corner of the layout space.

6. Using your mouse, left-click and drag the box to the area of your floor plan that will represent the shipping and receiving area.
7. To position the Don't Care box, drag one corner of the box to a corresponding corner and using one of the corner handles of the box, stretch it to fit.
You can also position the box by entering values in the **Left**, **Bottom**, **Right**, and **Top** fields.
8. Click **Save**, then **OK**.

Creating a Don't Deploy Area

1. Click the **New** link in the **Areas** section under **Floor 1** (named Entrance Level) to open the **Area Editor**.
2. Enter: **Lobby** in the **Name** text box in the **Area Editor**.
3. Select **Don't Deploy** from the **Type** drop-down menu box.
4. Click **Apply**.
Notice that an yellow box appears near the center of the floor plan.
5. Use your mouse (or other pointing device) to place the cursor over the box.
Notice that the information you typed in the editor appears in the box. You see the name and type of area, as well as the coordinates of the lower left corner and upper right corner of the box.



NOTE: The $x = 0$ and $y = 0$ coordinates correspond to the lower left corner of the layout space.

6. Using your mouse, left-click and drag the box to the area of your floor plan that you wish to designate are the Lobby Area.
7. To position the **Don't Deploy** box, drag one corner of the box to a corresponding corner and using one of the corner handles of the box, stretch it to fit.
8. You can also position the box by entering values in the **Left**, **Bottom**, **Right**, and **Top** fields.
9. Click **Save**, then **OK**.

Running the AP Plan

In this section you run the algorithm that searches for the best place to put the APs.

1. From the navigation tree, click **AP Plan** under the Planning section. The AP Planning page appears.
You might want to zoom in on the floor plan. Zoom in using the zoom drop-down near the top of the AP Planning page, or type a zoom factor in the text box at the left of the drop-down and press the enter key on your keyboard.
Try entering a zoom factor of 400.
Notice that the number of required APs displays towards the top of the page, which represents the same value that you saw when you modeled your APs on the AP Modeling Parameters page. Notice that the APs are not yet displayed on the floor plan.
2. Click **Initialize**.
You should see the required total number of AP symbols appear on the two floor diagrams. Also notice that the Suggested Access Points tables below each floor diagram have been populated with information about the suggested APs for each corresponding floor.
3. Click **Optimize**.
After you Initialize the APs you must optimize the algorithm. The APs move around on the floor plans as the algorithm is running.
The algorithm stops when the movement is less than a threshold value calculated based on the number of APs. The threshold value may be seen in the status bar at the bottom of the browser window.



NOTE: To see the approximate coverage areas of each of the APs, select an AP type from the Approx. Coverage drop-down box and select a rate from the **Coverage Rate** drop-down box.

4. Click **Save**, then **OK**.

Running the AM Plan

Running the AM Plan algorithm is similar to running the AP Plan.

1. From the navigation tree, click **AM Plan** under the Planning section. The AM Planning page appears.
2. Click **Initialize** then **Optimize**.
The algorithm stops when the movement is less than a threshold value calculated based on the number of AMs. The threshold value may be seen in the status bar at the bottom of the browser window.
3. Click **Save**, then **OK**.

Chapter 43

Behavior and Defaults

Topics in this chapter include:

- ["Understanding Mode Support" on page 824](#)
- ["Understanding Basic System Defaults" on page 825](#)
- ["Understanding Default Management User Roles" on page 832](#)
- ["Understanding Default Open Ports" on page 835](#)

Understanding Mode Support

Most ArubaOS features are supported in all forwarding modes. However, there are a some features that are not supported in one or more forwarding modes. Campus APs do not support split-tunnel forwarding mode and the decrypt-tunnel forwarding mode does not support TKIP Counter measure management on campus APs or remote APs.

[Table 399](#) describes the features that are not supported in each forwarding mode.

Table 399: *Features not Supported in Each Forwarding Mode*

Forwarding Mode	Feature Not Supported
Split Tunnel Mode on Remote APs	VLAN Pooling Named VLAN Voice over Mesh Video over Mesh Layer-2 Mobility Layer-3 Mobility IGMP Proxy Mobility Mobile IP TKIP countermeasure mgmt Bandwidth based CAC Dynamic Multicast Optimization
Bridge Mode on Campus APs or Remote APs	Firewall—SIP/SCCP/RTP/RTSP Voice Support Firewall—Alcatel NOE Support Voice over Mesh Video over Mesh Named VLAN Captive portal Rate Limiting for broadcast/multicast Power save: Wireless battery boost Power save: Drop wireless multicast traffic Power save: Proxy ARP (global) Power save: Proxy ARP (per-SSID) Automatic Voice Flow Classification
Bridge Mode on Campus APs or Remote APs	SIP ALG

Forwarding Mode	Feature Not Supported
(continued)	SIP: SIP authentication tracking SIP: CAC enforcement enhancements SIP: Phone number awareness SIP: R-Value computation SIP: Delay measurement Management: Voice-specific views Management: Voice client statistics Management: Voice client troubleshooting Voice protocol monitoring/reporting SVP ALG H.323 ALG Vocera ALG SCCP ALG NOE ALG Layer 3 Mobility IGMP Proxy Mobility Mobile IP TKIP countermeasure mgmt Bandwidth based CAC Dynamic Multicast Optimization

Understanding Basic System Defaults

The default administrator user name is **admin**, and the default password is also **admin**. The ArubaOS software includes several predefined network services, firewall policies, and roles.

Network Services

Table 400 lists the predefined network services and their protocols and ports.

Table 400: Predefined Network Services

Name	Protocol	Port(s)
svc-dhcp	udp	67 68
svc-snmp-trap	udp	162
svc-smb-tcp	tcp	445
svc-https	tcp	443
svc-ike	udp	500
svc-l2tp	udp	1701
svc-syslog	udp	514
svc-pptp	tcp	1723
svc-telnet	tcp	23
svc-sccp	tcp	2000

Name	Protocol	Port(s)
svc-tftp	udp	69
svc-sip-tcp	tcp	5060
svc-kerberos	udp	88
svc-pop3	tcp	110
svc-adp	udp	8200
svc-noe	udp	32512
svc-noe-oxo	udp	5000
svc-dns	udp	53
svc-msrpc-tcp	tcp	135 139
svc-rtsp	tcp	554
svc-http	tcp	80
svc-vocera	udp	5002
svc-nterm	tcp	1026 1028
svc-sip-udp	udp	5060
svc-papi	udp	8211
svc-ftp	tcp	21
svc-natt	udp	4500
svc-svp	119	0
svc-gre	gre	0
svc-smtp	tcp	25
svc-smb-udp	udp	445
svc-esp	esp	0
svc-bootp	udp	67 69
svc-snmp	udp	161
svc-icmp	icmp	0
svc-ntp	udp	123
svc-msrpc-udp	udp	135 139

Name	Protocol	Port(s)
svc-ssh	tcp	22
svc-h323-tcp	tcp	1720
svc-h323-udp	udp	1718 1719
svc-http-proxy1	tcp	3128
svc-http-proxy2	tcp	8080
svc-http-proxy3	tcp	8888
svc-sips	tcp	5061
svc-v6-dhcp	udp	546 547
svc-v6-icmp	icmp	0
any	any	0

Policies

The following are predefined policies.

Table 401: Predefined Policies

Predefined Policy	Description
<pre>ip access-list session allowall any any any permit</pre>	An "allow all" firewall rule that permits all traffic.
<pre>ip access-list session control user any udp 68 deny any any svc-icmp permit any any svc-dns permit any any svc-papi permit any any svc-cfgm-tcp permit any any svc-adp permit any any svc-tftp permit any any svc-dhcp permit any any svc-natt permit</pre>	Controls traffic—Apply to untrusted wired ports in order to allow Dell APs to boot up. NOTE: In most cases wired ports should be made "trusted" when attached to an internal network.
<pre>ip access-list session captiveportal user alias mswitch svc-https dst-nat 8081 user any svc-http dst-nat 8080 user any svc-https dst-nat 8081 user any svc-http-proxy1 dst-nat 8088 user any svc-http-proxy2 dst-nat 8088 user any svc-http-proxy3 dst-nat 8088</pre>	Enables Captive Portal authentication. <ol style="list-style-type: none"> Any HTTPS traffic destined for the controller will be NATed to port 8081, where the captive portal server will answer. All HTTP traffic to any destination will be NATed to the controller on port 8080, where an HTTP redirect will be issued. All HTTPS traffic to any destination will be NATed to the controller on port 8081, where an HTTP redirect will be issued. All HTTP proxy traffic will be NATed to the controller on port 8088.

Predefined Policy	Description
	NOTE: In order for captive portal to work properly, DNS must also be permitted. This is normally done in the "logon-control" firewall rule.
<pre>ip access-list session clogout user alias mswitch svc-https dst-nat 8081</pre>	Used to enable the captive portal "logout" window. If the user attempts to connect to the controller on the standard HTTPS port (443) the client will be NATed to port 8081, where the captive portal server will answer. If this rule is not present, a wireless client may be able to access the controller's administrative interface.
<pre>ip access-list session vpnlogon any any svc-ike permit any any svc-esp permit any any svc-l2tp permit any any svc-pptp permit any any svc-gre permit</pre>	This policy permits VPN sessions to be established to any destination. IPsec (IKE, ESP, and L2TP) and PPTP (PPTP and GRE) are supported.
<pre>ip access-list session ap-acl any any udp 5000 any any udp 5555 any any svc-gre permit any any svc-syslog permit any user svc-snmp permit user any svc-snmp-trap permit user any svc-ntp permit</pre>	This is a policy for internal use and should not be modified. It permits APs to boot up and communicate with the controller.
<pre>ip access-list session validuser any any any permit</pre>	This firewall rule controls which users will be added to the user-table of the controller through untrusted interfaces. Only IP addresses permitted by this ACL will be admitted to the system for further processing. If a client device attempts to use an IP address that is denied by this rule, the client device will be ignored by the controller and given no network access. You can use this rule to restrict foreign IP addresses from being added to the user-table. This policy should not be applied to any user role, it is an internal system policy.
<pre>ip access-list session vocera-acl any any svc-vocera permit queue high</pre>	Use for Vocera VoIP devices to automatically permit and prioritize Vocera traffic.
<pre>ip access-list session icmp-acl any any svc-icmp permit</pre>	Permits all ICMP traffic.
<pre>ip access-list session sip-acl any any svc-sip-udp permit queue high any any svc-sip-tcp permit queue high</pre>	Use for SIP VoIP devices to automatically permit and prioritize all SIP control and data traffic.
<pre>ip access-list session https-acl</pre>	Permits all HTTPS traffic.

Predefined Policy	Description
any any svc-https permit	
ip access-list session dns-acl any any svc-dns permit	Permits all DNS traffic.
ip access-list session logon-control user any udp 68 deny any any svc-icmp permit any any svc-dns permit any any svc-dhcp permit any any svc-natt permit	The default pre-authentication role that should be used by all wireless clients. Prohibits the client from acting as a DHCP server. Permits all ICMP, DNS, and DHCP. Also permits IPsec NAT-T (UDP 4500). Remove NAT-T if not needed.
ip access-list session srcnat user any any src-nat	This policy can be used to source-NAT all traffic. Because no NAT pool is specified, traffic that matches this policy will be source NATed to the IP address of the controller.
ip access-list session skinny-acl any any svc-sccp permit queue high	Use for Cisco Skinny VoIP devices to automatically permit and prioritize VoIP traffic.
ip access-list session tftp-acl any any svc-tftp permit	Permits all TFTP traffic.
ip access-list session guest	This policy is not used.
ip access-list session dhcp-acl any any svc-dhcp permit	Permits all DHCP traffic. If DHCP is not allowed, clients will not be able to request or renew IP addresses.
ip access-list session http-acl any any svc-http permit	Permits all HTTP traffic.
ip access-list session svp-acl any any svc-svp permit queue high user host 224.0.1.116 any permit	Use for Spectralink VoIP devices to automatically permit and prioritize Spectralink Voice Protocol (SVP).
ip access-list session noe-acl any any svc-noe permit queue high	Use for Alcatel NOE VoIP devices to automatically permit and prioritize NOE traffic.
ip access-list session h323-acl any any svc-h323-tcp permit queue high any any svc-h323-udp permit queue high	Use for H.323 VoIP devices to automatically permit and prioritize H.323 traffic.
ipv6 access-list session v6-control user any udp 68 deny any any svc-v6-icmp permit any any svc-v6-dhcp permit any any svc-dns permit any any svc-tftp permit	Provides equivalent functionality to the "control" policy, but for IPv6 clients.
ipv6 access-list session v6-icmp-acl any any svc-v6-icmp permit	Permits all ICMPv6 traffic.
ipv6 access-list session v6-https-acl any any svc-https permit	Permits all IPv6 HTTPS traffic.

Predefined Policy	Description
<pre>ipv6 access-list session v6-dhcp-acl any any svc-v6-dhcp permit</pre>	Permits all IPv6 DHCP traffic.
<pre>ipv6 access-list session v6-dns-acl any any svc-dns permit</pre>	Permits all IPv6 DNS traffic.
<pre>ipv6 access-list session v6-allowall any any any permit</pre>	Permits all IPv6 traffic.
<pre>ipv6 access-list session v6-http-acl any any svc-http permit</pre>	Permits all IPv6 HTTP traffic.
<pre>ipv6 access-list session v6-tftp-acl any any svc-tftp permit</pre>	Permits all IPv6 TFTP traffic.
<pre>ipv6 access-list session v6-logon-control user any udp 68 deny any any svc-v6-icmp permit any any svc-v6-dhcp permit any any svc-dns permit</pre>	Provides equivalent functionality to the "logon-control" policy, but for IPv6 clients.

Roles

The following are predefined roles.



NOTE: If you upgrade from a previous ArubaOS release, your existing configuration may have additional or different predefined roles. The information in this section only describes the predefined roles for this release.

Table 402: Predefined Roles

Predefined Role	Description
<pre>user-role ap-role session-acl control session-acl ap-acl</pre>	This is an internal role and should not be edited.
<pre>user-role default-vpn-role session-acl allowall ipv6 session-acl v6-allowall</pre>	This is the default role used for VPN-connected clients. It is referenced in the default "aaa authentication vpn" profile.
<pre>user-role voice session-acl sip-acl session-acl noe-acl session-acl svp-acl session-acl vocera-acl session-acl skinny-acl session-acl h323-acl session-acl dhcp-acl session-acl tftp-acl session-acl dns-acl session-acl icmp-acl</pre>	This role can be applied to voice devices in order to automatically permit and prioritize all VoIP protocols.
<pre>user-role guest session-acl http-acl</pre>	This is a default role for guest users. It permits only HTTP, HTTPS,

Predefined Role	Description
<pre> session-acl https-acl session-acl dhcp-acl session-acl icmp-acl session-acl dns-acl ipv6 session-acl v6-http-acl ipv6 session-acl v6-https-acl ipv6 session-acl v6-dhcp-acl ipv6 session-acl v6-icmp-acl ipv6 session-acl v6-dns-acl </pre>	<p>DHCP, ICMP, and DNS for the guest user. To increase security, a "deny" rule for internal network destinations could be added at the beginning.</p>
<pre> user-role guest-logon captive-portal default session-acl logon-control session-acl captiveportal </pre>	<p>This role is used as the pre-authentication role for guest SSIDs. It allows control traffic such as DNS, DHCP, and ICMP, and also enables captive portal.</p>
<pre> user-role <ssid>-guest-logon captive-portal default session-acl logon-control session-acl captiveportal </pre>	<p>This role is only generated when creating a new WLAN using the WLAN Wizard. The WLAN Wizard creates this role when captive portal is enabled. This is the initial role that a guest will be placed in prior to captive portal authentication. By using a different guest logon role for each SSID, it is possible to enable multiple captive portal profiles with different customization.</p>
<pre> user-role stateful-dot1x </pre>	<p>This is an internal role used for Stateful 802.1x. It should not be edited.</p>
<pre> user-role authenticated session-acl allowall ipv6 session-acl v6-allowall </pre>	<p>This is a default role that can be used for authenticated users. It permits all IPv4 and IPv6 traffic for users who are part of this role.</p>
<pre> user-role logon session-acl logon-control session-acl captiveportal session-acl vpnlogon ipv6 session-acl v6-logon-control </pre>	<p>This is a system role that is normally applied to a user prior to authentication. This applies to wired users and non-802.1x wireless users.</p> <p>The role allows certain control protocols such as DNS, DHCP, and ICMP, and also enables captive portal and VPN termination/pass through. The logon role should be edited to provide only the required services to a pre-authenticated user. For example, VPN pass through should be disabled if it is not needed.</p>
<pre> user-role <ssid>-logon session-acl control session-acl captiveportal session-acl vpnlogon </pre>	<p>This role is only generated when creating a new WLAN using the WLAN Wizard. The WLAN Wizard creates this role when captive portal is enabled and a PEFNG license is installed. This is the initial role that a client will be placed in prior to captive portal authentication. By using a different logon role for each SSID, it is possible to enable multiple captive portal profiles with different customization.</p>
<pre> user-role <ssid>-captiveportal- profile </pre>	<p>When utilizing the WLAN Wizard and you do not have a PEFNG installed and you are configuring an Internal or Guest WLAN with captive portal enabled, the controller creates an implicit user role with the same name as the captive portal profile, <ssid>-captiveportal-profile.</p> <p>This implicit user role allows only DNS and DHCP traffic between the client and network and directs all HTTP or HTTPS requests to the captive portal. You cannot directly modify the implicit user role or its rules. Upon authentication, captive portal clients are allowed full access to their assigned VLAN. Once the WLAN configuration is pushed to the controller, the WLAN wizard will associate the new role with the initial user role that you specify in the AAA profile. This role will not be visible to the user in the WLAN wizard.</p>

Understanding Default Management User Roles

The ArubaOS software includes predefined management user roles.



NOTE: If you upgrade from a previous ArubaOS release, your existing configuration may have different management roles. The information in this section only describes the predefined management roles for this release.

Table 403: Predefined Management Roles

Predefined Role	Permissions
root	This role permits access to all management functions (commands and operations) on the controller.
read-only	This role permits access to CLI <code>show</code> commands or WebUI monitoring pages only.
guest-provisioning	This role permits access to configuring guest users in the controller's internal database only. This user only has access via the WebUI to create guest accounts; there is no CLI access. Guest-provisioning tasks include creating or generating the user name and password for a guest account as well as configuring when the account expires.
location-api-mgmt	This role permits access to location API information and the CLI; however, you cannot use any CLI commands. This role does not permit access to the WebUI. Using a third-party location appliance, you can gather information about the location of 802.11 stations. To log in to the controller using a third-party location appliance, enter: <code>http[s]://<ipaddress>[:port]/screens/wms/wms.login</code> . You are prompted to enter your username and password (for example, the username and password associated with the location API management role). Once authenticated, you can use an API call to request location information from the controller, for example: <code>http[s]://<ipaddress>[:port]/screens/wms/wms.cgi?opcode=wlm-get-spot&campus-name=<campus id>&building-name<building id>&mac=<client1>,<client2>....</code>
network-operations	This role supports a subset of show, configuration, action, and database commands that are used to monitor the controller. You can log into the CLI; however, you can only use a subset of CLI commands to monitor the controller. This role permits the following WebUI pages and associated CLI commands: As a network-operations user, commands with an asterisk (*) are hidden in the CLI but are executed and visible from the WebUI. Plan Page <ul style="list-style-type: none"> You can move APs on the floor plan and save their new location. You cannot change or modify the AP configuration. Reports Page <ul style="list-style-type: none"> You can view all of the available reports. Events Page <ul style="list-style-type: none"> You can view all of the available events. Monitoring Page You can view the reports created by the following CLI commands: <ul style="list-style-type: none"> <code>show keys all</code> <code>show mobility-managers</code> <code>show roleinfo</code> <code>show license*</code> <code>show ap essid</code> <code>DB:opcode=cr-load</code> Monitoring > Network > Network Summary You can view the reports created by the following CLI commands: <ul style="list-style-type: none"> <code>show interface vlan <id></code>

Predefined Role	Permissions
	<ul style="list-style-type: none"> ● show interface loopback ● show datapath utilization ● show aaa state configuration ● show user-table unique ● show aaa authentication-server all ● show switches summary ● show ap blacklist-clients ● show wlan-ap-count type access-points* ● show wlan-ap-count type air-monitor* ● show wlan-ap-count type secure-access* ● show user-table verbose ● show ap database unprovisioned page <page> ● show ap-group default ● show wlan virtual-ap ● show rf dot11a-radio-profile ● show rf dot11g-radio-profile ● show ap wired-ap-profile ● show ap enet-link-profile ● show ap system-profile ● show wlan voip-cac-profile ● show wlan traffic-management-profile ● show ap regulatory-domain-profile ● show ap snmp-profile ● show rf optimization-profile ● show rf event-thresholds-profile ● show ids profile ● show rf arm-profile ● show ap association bssid
network-operations (continued)	<p>Monitoring > Network > All Access Points Monitoring > Network > All Wired Access Points You can view the reports created by the following CLI commands:</p> <ul style="list-style-type: none"> ● DB:opcode=monitor-summary ● DB:opcode=cr-load ● DB:opcode=wlm-search&class=probes&start ● DB:opcode=wlm-search&class=amii ● DB:opcode=monitor-get-all-gps&status=any ● show ap-group ● show vlan status <p>Monitoring > Controller > Controller Summary You can view the reports created by the following CLI commands:</p> <ul style="list-style-type: none"> ● show switches ● show switches summary <p>Monitoring > Controller > Air Monitors You can view the reports created by the following CLI commands:</p> <ul style="list-style-type: none"> ● show wlan-ap start* <p>Monitoring > Controller > Clients You can view the reports created by the following CLI commands:</p> <ul style="list-style-type: none"> ● show ip mobile host ● show ip mobile trail {<ipaddr> <macaddr>} ● show esi groups ● show esi servers ● show esi ping

Predefined Role	Permissions
	<ul style="list-style-type: none"> ● show esi parser stats ● show private port status* ● show vlan ● show port stats ● show spanning-tree interface fastethernet <slot/port> ● show interface fastethernet <slot/port> counters ● clear counters fastethernet <slot/port> ● show snmp trap-queue <page> <p>Monitoring > Controller > Clients > Packet CaptureMonitoring >Controller > Clients > LocateMonitoring > Controller > Clients > Debug</p> <p>You can view the reports created by the following CLI commands:</p> <ul style="list-style-type: none"> ● aaa user debug mac <p>Monitoring > Controller> Clients > Disconnect</p> <p>You can view the reports created by the following CLI commands:</p> <ul style="list-style-type: none"> ● stm kick-off-sta <macaddr> ● aaa user logout <ipaddr>
network-operations (continued)	<p>Monitoring > Controller> Clients > Blacklist</p> <p>You can view the reports created by the following CLI commands:</p> <ul style="list-style-type: none"> ● stm add-blacklist-client <macaddr> ● aaa user delete {<ipaddr> all mac <macaddr> name <username> role <role>} <p>Monitoring > Controller > Blacklist Clients</p> <p>You can view the reports created by the following CLI commands:</p> <ul style="list-style-type: none"> ● stm remove-blacklist-client <macaddr> <p>Monitoring > Controller > External Services Interface</p> <p>You can view the reports created by the following CLI commands:</p> <ul style="list-style-type: none"> ● show esi groups ● show esi servers ● show esi ping ● show esi parser stats <p>Monitoring > Controller > Ports</p> <p>You can view the reports created by the following CLI commands:</p> <ul style="list-style-type: none"> ● show model-switch-internal* ● show slots ● show private port status* ● show vlan <p>Monitoring > Controller> Inventory</p> <p>You can view the reports created by the following CLI commands:</p> <ul style="list-style-type: none"> ● show keys <p>Monitoring > WLAN</p> <p>You can view the reports created by the following CLI commands:</p> <ul style="list-style-type: none"> ● DB:opcode=get-permissions ● DB:opcode=cr-load ● show switches ● show switches summary <p>Monitoring > Voice</p> <p>You can view the reports created by the following CLI commands:</p> <ul style="list-style-type: none"> ● show ap association voip-only ● show ap active voip-only

Predefined Role	Permissions
	<ul style="list-style-type: none"> • show voice call-counters • show voice client status • show voice call-quality • show voice call-density • show voice call-cdrs • show voice call-perf

Understanding Default Open Ports

By default, Dell controllers and access points treat ports as untrusted. However, certain ports are open by default only on the trusted side of the network. These open ports are listed in [Table 404](#).

Table 404: *Default (Trusted) Open Ports*

Port Number	Protocol	Where Used	Description
17	TCP	controller	This is use for certain types of VPN clients that accept a banner (QOTD). During normal operation, this port will only accept a connection and immediately close it.
21	TCP	controller	
22	TCP	controller	SSH
23	TCP	AP and controller	Telnet is disabled by default but the port is still open.
53	UDP	controller	Internal domain.
67	UDP	AP (and controller if DHCP server is configured)	DHCP server.
68	UDP	AP (and controller if DHCP server is configured)	DHCP client.
69	UDP	controller	TFTP
80	TCP	AP and controller	HTTP Used for remote packet capture where the capture is saved on the Access Point. Provides access to the WebUI on the controller.
123	UDP	controller	NTP
161	UDP	AP and controller	SNMP. Disabled by default.
443	TCP	controller	Used internally for captive portal authentication (HTTPS) and is exposed to wireless users. A default self-signed certificate is installed in the controller. Users in a production environment are urged to install a certificate from a well known CA such as Verisign. Self-signed certs are open to man-in-the-middle attacks and should only be used for testing.

Port Number	Protocol	Where Used	Description
			Required for VIA: During the initializing phase, VIA uses HTTPS connections to perform trusted network and captive portal checks against the controller. It is mandatory that you enable port 443 on your network to allow VIA to perform these checks
500	UDP	controller	ISAKMP
514	UDP	controller	Syslog
1701	UDP	controller	L2TP
1723	TCP	controller	PPTP
2300	TCP	controller	Internal terminal server opened by <code>telnet soe</code> command.
3306	TCP	controller	Remote wired MAC lookup.
4343	TCP	controller	Users in a production environment are urged to install a certificate from a well known CA such as Verisign. Self-signed certs are open to man-in-the-middle attacks and should only be used for testing
4500	UDP	controller	sae-urn Required for VIA: During the initializing phase, VIA uses HTTPS connections to perform trusted network and captive portal checks against the controller. It is mandatory that you enable port 4500 on your network to allow VIA to perform these checks
8080	TCP	controller	Used internally for captive portal authentication (HTTP-proxy). This port is not exposed to wireless users.
8081	TCP	controller	Used internally for captive portal authentication (HTTPS). Not exposed to wireless users. A default self-signed certificate is installed in the controller. Users in a production environment are urged to install a certificate from a well known CA such as Verisign. Self-signed certs are open to man-in-the-middle attacks and should only be used for testing.
8082	TCP	controller	Used internally for single sign-on authentication (HTTP). Not exposed to wireless users.
8083	TCP	controller	Used internally for single sign-on authentication (HTTPS). Not exposed to wireless users.
8088	TCP	controller	For internal use.
8200	UDP	controller	The Aruba Discovery Protocol (ADP)
8211	UDP	controller	For internal use.
8888	TCP	controller	Used for HTTP access.

Chapter 44

DHCP with Vendor-Specific Options

This chapter describes how to configure several DHCP vendor-specific options.

Topics in this chapter include:

- ["Configuring a Windows-Based DHCP Server" on page 837](#)
- ["Enabling DHCP Relay Agent Information Option \(Option 82\)" on page 840](#)
- ["Enabling Linux DHCP Servers" on page 840](#)

Configuring a Windows-Based DHCP Server

Configuring a Microsoft Windows-based DHCP server to send option 43 to the DHCP client on a Dell AP consists of the following two tasks:

- Configuring Option 60
- Configuring Option 43

DHCP servers are a popular way of configuring clients with basic networking information such as an IP address, a default gateway, network mask, DNS server, and so on. Most DHCP servers have the ability to also send a variety of optional information, including the Vendor-Specific Option Code, also called option 43.

When a client or an AP requests for option 43 (Vendor Specific Information), the controller responds with the value configured by administrator in the DHCP pool.

Configuring Option 60

This section describes how to configure the Vendor Class Identifier Code (option 60) on a Microsoft Windows-based DHCP server.

As mentioned in the overview section, option 60 identifies and associates a DHCP client with a particular vendor. Any DHCP server configured to take action based on a client's vendor ID should also have this option configured.

Since option 60 is not a predefined option on a Windows DHCP server, you must add it to the option list for the server.

To configure option 60 on the Windows DHCP server

1. On the DHCP server, open the DHCP server administration tool by clicking **Start > Administrative Tools > DHCP**.
2. Find your server and right-click on the scope to be configured under the server name. Select **Set Predefined Options**.
3. In the Predefined Options and Values dialog box, click the **Add** button.
4. In the Option Type dialog box, enter the following information

Table 405: Configure option 60 on the Windows DHCP server

Field	Information
Name	Dell Access Point
Data Type	String
Code	60
Description	Dell AP vendor class identifier

5. Click **OK** to save this information.
6. In the Predefined Options and Values dialog box, make sure **060 Dell Access Point** is selected from the Option Name drop-down list.
7. In the Value field, enter the following information:
String : ArubaAP
8. Click **OK** to save this information.
9. Under the server, select the scope you want to configure and expand it. Select **Scope Options** and expand it. Then select **Configure Options**.
10. In the Scope Options dialog box, scroll down and select **060 Dell Access Point**. Confirm the value is set to **ArubaAP** and click **OK**.
11. Confirm that the option **060 Dell Access Point** is listed in the right pane.

Configuring Option 43

Configuring Option 43 returns the IP address of the Dell master controller to a Dell DHCP client. This information allows Dell APs to auto-discover the master controller and obtain their configuration.

To configure option 43 on the Windows DHCP server:

1. On the DHCP server, open the DHCP server administration tool by clicking **Start > Administration Tools > DHCP**.
2. Find your server and right-click on the scope to be configured under the server name. Click on the Scope Options entry and select **Configure Options**.
3. In the Scope Options dialog box ([Figure 406](#)), scroll down and select **043 Vendor Specific Info**.

Figure 406: Scope Options Dialog Box.

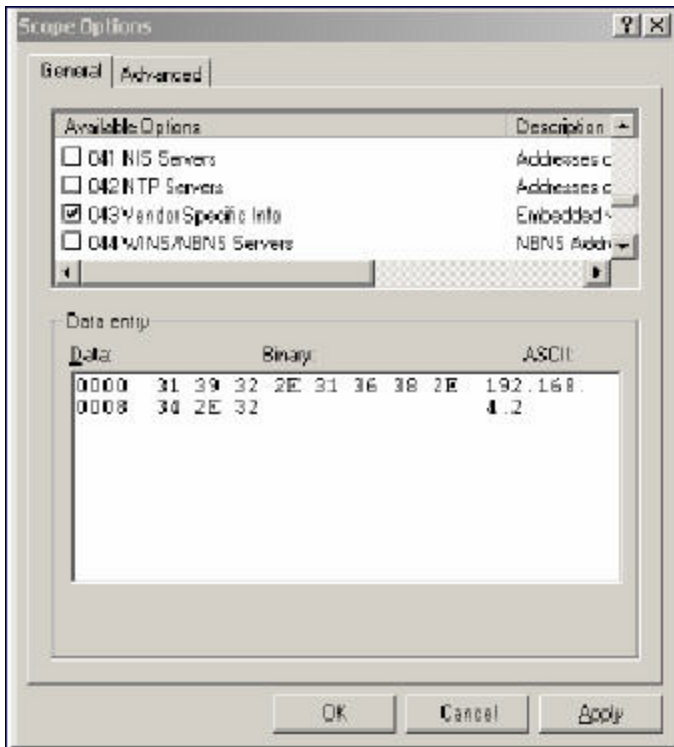

4. In the Data Entry field, click anywhere in the area under the ASCII heading and enter the following information:
ASCII : Loopback address of the master controller
5. Click the **OK** button to save the configuration.

Option 43 is configured for this DHCP scope. Note that even though you entered the IP address in ASCII text, it displays in binary form.

Figure 407: DHCP Scope Values

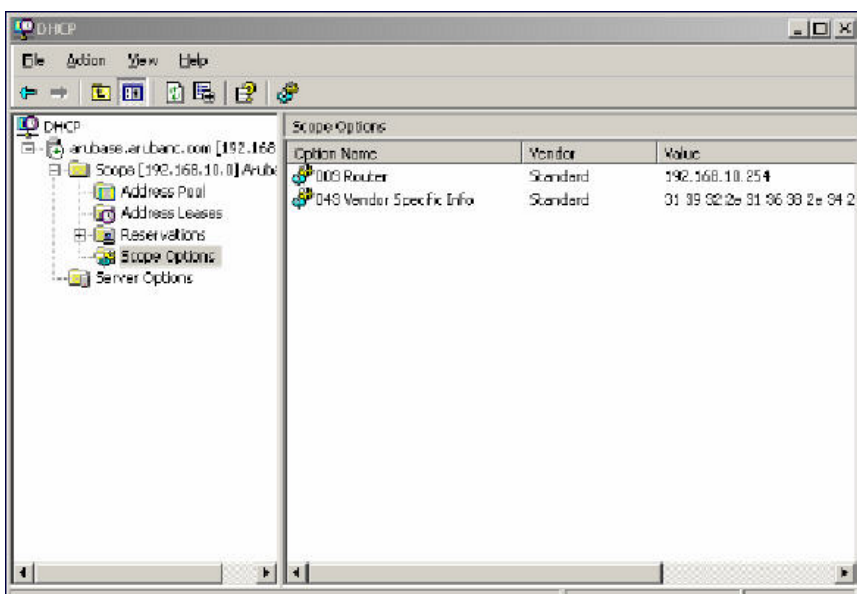

Enabling DHCP Relay Agent Information Option (Option 82)

The DHCP Relay Agent Information option (Option 82) allows the DHCP Relay Agent to insert circuit specific information into a request that is being forwarded to a DHCP server.

The controller, when acting as a DHCP relay agent, inserts information about the AP and SSID through which a client is connecting into the DHCP request. Many service providers use this mechanism to make access control decisions.

Configuring Option 82

You can configure Option 82 using the WebUI or the CLI. You can include only the MAC address or MAC address and ESSID. The MAC address is the hardware address and ESSID is an alphanumeric name that uniquely identifies a wireless network.

In the WebUI

1. Navigate to **Configuration > Network > IP > IP Interfaces**.
2. Click **Edit** next to the VLAN ID for which you want to configure Option 82.
3. Under DHCP Helper Address select **Mac** or **Mac Essid** from the Option-82 drop-down menu.
4. Click **Apply**.

In the CLI

This example enables Option 82 for VLAN 5 using ESSID. You can include only the MAC address or MAC address and ESSID.

```
(host) (config) #interface vlan 5
(host) (config-subif)#option-82
(host) (config-subif)#option-82 mac essid
(host) (config-subif)#
```

Enabling Linux DHCP Servers

The following is an example configuration for the Linux dhcpd.conf file. After you enter the configuration, you must restart the DHCP service.

```
option serverip code 43 = ip-address;
class "vendor-class" {
    match option vendor-class-identifier;
}
.
.
.
subnet 10.200.10.0 netmask 255.255.255.0 {
    default-lease-time 200;
    max-lease-time 200;
    option subnet-mask 255.255.255.0;
    option routers 10.200.10.1;
    option domain-name-servers 10.4.0.12;
    option domain-name "vlan10.aa.mycorpnetworks.com";
    subclass "vendor-class" "ArubaAP" {
        option vendor-class-identifier "ArubaAP";
    }
}
#
# option serverip <loopback-IP-address-of-master-controller>
#
    option serverip 10.200.10.10;
}
```



```
range 10.200.10.200 10.200.10.252;  
}
```

802.1X Configuration for IAS and Windows Clients

This chapter provides examples of how to configure a Microsoft Internet Authentication Server, and a Windows XP wireless client for 802.1X authentication with the controller (see [802.1X Authentication on page 192](#)). for information about configuring the controller

For more information about configuring computers in a Windows environment for PEAP-MS-CHAPv2 and EAP-TLS authentication, see the Microsoft document *Step-by-Step Guide for Setting Up Secure Wireless Access in a Test Lab*, available from Microsoft's Download Center (at www.microsoft.com/downloads). Additional information on client configuration is available at <http://www.microsoft.com/technet/prodtechnol/winxp/maintain/wificomp.msp#EQGAC>.

This chapter describes the following topics:

- "Configuring Microsoft IAS" on page 842
- "Configuring Management Authentication using IAS" on page 847
- "Window XP Wireless Client Sample Configuration" on page 850

Configuring Microsoft IAS

Microsoft Internet Authentication Server (IAS) provides authentication functions for the wireless network. IAS implements the RADIUS protocol, which is used between the Dell controller and the server. IAS uses Active Directory as the database for looking up computers, users, passwords, and group information.

RADIUS Client Configuration

Each device in the network that needs to authenticate to a RADIUS server must be configured as a RADIUS client. You must configure the Dell controller as a RADIUS client.



NOTE: The steps to perform this task may vary depending on the version of Windows currently running on your server. For complete details on configuring Windows IAS, refer to the Windows documentation available (at www.microsoft.com/downloads).

To configure a RADIUS client:

1. From your windows server, navigate to **Start > Settings > Control Panel > Administrative Tools>Internet Authentication Service**.
2. In the Internet Authentication Service window, select **RADIUS Clients**.

Figure 408: IAS RADIUS Clients

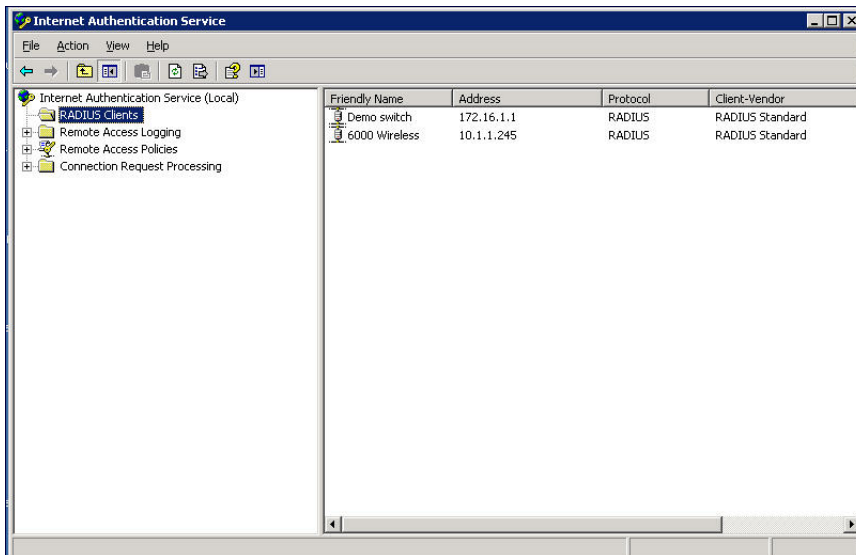

3. To configure a RADIUS client, select **Action > New RADIUS Client** from the menu at the top of the window.
4. In the **New RADIUS Client** dialog window, enter the name and IP address for the controller. Click **Next**.
5. In the next window that appears, enter and confirm a shared secret. The shared secret is configured on both the RADIUS server and client, and ensures that an unauthorized client cannot perform authentication against the server.
6. Click **Finish**.

Remote Access Policies

The IAS policy configuration defines all policies related to wireless access, including time of day restrictions, session length, authentication type, and group-related policies. See Microsoft product documentation for detailed descriptions and explanations of IAS policy settings.

Active Directory Database

The Active Directory database serves as the master authentication database for both the wired and wireless networks. The IAS authentication server bases all authentication decisions on information in the Active Directory database. IAS is normally used as an authentication server for remote access and thus looks to the Active Directory “Remote Access” property to determine whether authentication requests should be allowed or denied. This property is set on a per-user or per-computer basis. For a user or computer to be allowed access to the wireless network, the remote access property must be set to “Allow access”.

The authentication policy configured in IAS depends on the group membership of the computer or user in Active Directory. These policies are responsible for passing group information back to the controller for use in assigning computers or users to the correct role, which determines their network access privileges. When the IAS server receives a request for authentication, it compares the request with the list of remote access policies. The first policy to match the request is executed; additional policies are not searched.

Configuring Policies

The policies in this 802.1x authentication example are designed to work by examining the username portion of the authentication request, searching the Active Directory database for a matching name, and then examining the group

membership for a computer or user entry that matches. For example, the following policies would operate with the controller configuration shown in ["Configuring Authentication with an 802.1X RADIUS Server" on page 204](#):

- The Wireless-Computers policy matches the “Domain Computers” group. This group contains the list of all computers that are members of the domain. This group is used for all computers to authenticate to the network.
- The Wireless-Student policy matches the “Student” group. This group is used for all student users.
- The Wireless-Faculty policy matches the “Faculty” group. This group is used for all faculty users.
- The Wireless-Sysadmin policy matches the “Sysadmin” group. This group is used for system administrators.

In addition to matching the respective group, the policy also specifies that the request must be from an 802.11 wireless device. The policy instructs IAS to grant remote access permission if all the conditions specified in the policy match, a valid username/password is supplied, the user’s or computer’s remote access permission is set to “Allow”.

To configure a policy:

1. In the **Internet Authentication Service** window, select **Remote Access Policies**.

Figure 409: IAS Remote Access Policies

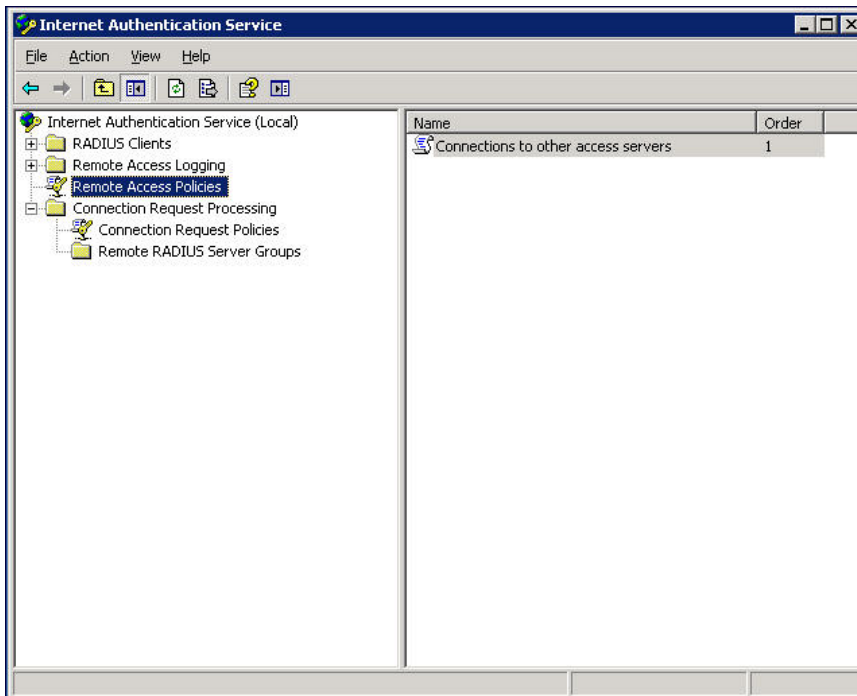

2. To add a new policy, select **Action > New Remote Access Policy**. This launches a wizard that steps you through configuring the remote access policy.
3. Click **Next** on the initial wizard window to proceed.
4. Enter the name for the policy, for example, “Wireless Computers” and click **Next**.
5. In the **Access Method** window, select the **Wireless** option, then click **Next**.
6. in the **User or Group Access** window, select **Group** and click **Add** to add the group of users to which this policy applies (for example, “Domain Computers”). Click **Next**.
7. For Authentication Methods, select either **Protected EAP (PEAP)** or **Smart Card or other certificate**.
8. Click **Configure** to select additional properties.

Figure 410: Policy Configuration Wizard—Authentication Methods

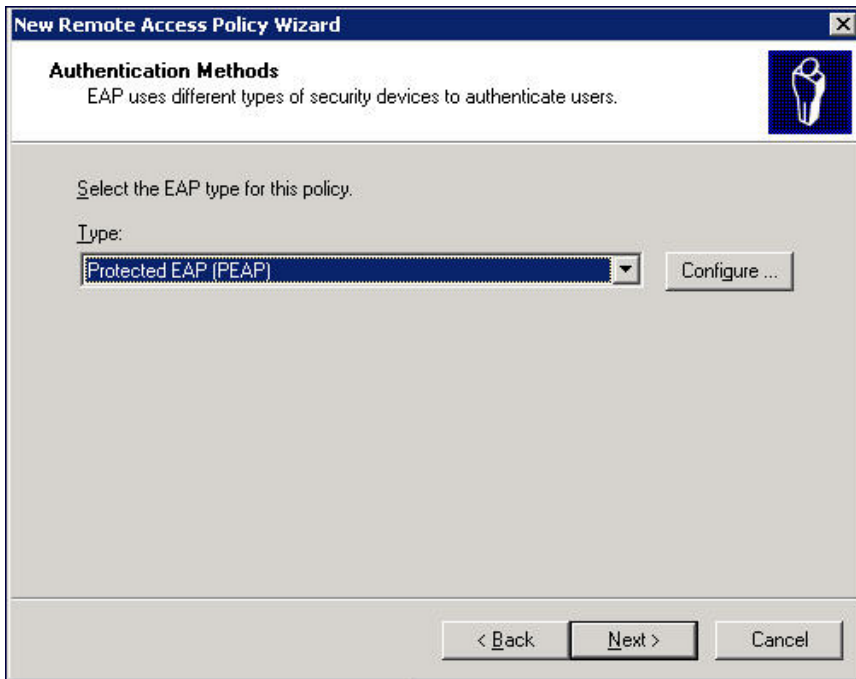

9. Select a server certificate. The list of available certificates is taken from the computer certificate store on which IAS is running. In this case, a self-signed certificate was generated by the local certificate authority and installed on the IAS system. On each wireless client device, the local certificate authority is added as a trusted certificate authority, thus allowing this certificate to be trusted.

Figure 411: Policy Configuration Wizard—PEAP Properties

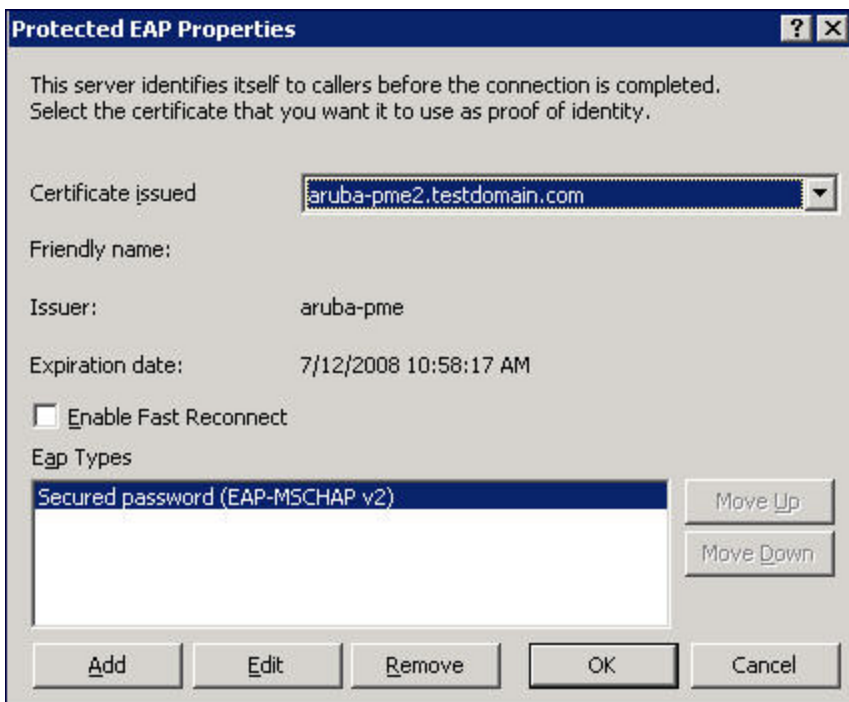

10. For PEAP, select the “inner” authentication method. The authentication method shown is MS-CHAPv2. (Because password authentication is being used on this network, this is the only EAP authentication type that should be selected.)

You can also enable fast reconnect in this screen. If you enable fast reconnect here and also on client devices, additional time can be saved when multiple authentications take place (such as when clients are roaming between APs frequently) because the server will keep the PEAP encrypted tunnel alive.

11. Click OK.

Configuring RADIUS Attributes

In the configuration example for 802.1x, the controller restricts network access privileges based on the group membership of the computer or user. In order for this to work, the controller must be told to which group the user belongs. This is accomplished using RADIUS attributes returned by the authentication server.

To configure RADIUS attributes:

1. In the **Internet Authentication Service** window, select **Remote Access Policies**.
1. Open the remote access policy you want to configure, and select the **Advanced** tab.
2. Click **Add** to configure an attribute.
3. Select the **Class** attribute.
4. Enter the value for this attribute. For example, for the **Wireless-Computers** policy, the **Class** attribute returned to the controller should contain the value “computer”.

Figure 412: RADIUS class Attribute Configuration

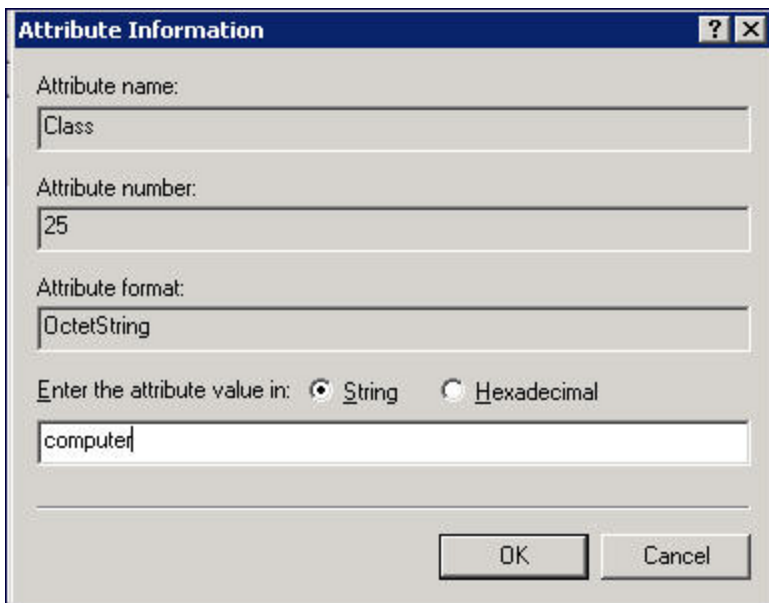

The screenshot shows a dialog box titled "Attribute Information" with a question mark and close button in the top right corner. The dialog contains the following fields and options:

- Attribute name:** A text box containing "Class".
- Attribute number:** A text box containing "25".
- Attribute format:** A text box containing "OctetString".
- Enter the attribute value in:** Two radio buttons: "String" (selected) and "Hexadecimal".
- Value:** A text box containing "computer".
- Buttons:** "OK" and "Cancel" buttons at the bottom right.

5. Click OK.
6. Click OK.

Another example of a Class attribute configuration is shown below for the “Wireless-Student” policy. This policy returns the RADIUS attribute Class with the value “student” upon successful completion.

Figure 413: Example RADIUS Class Attribute for “student”

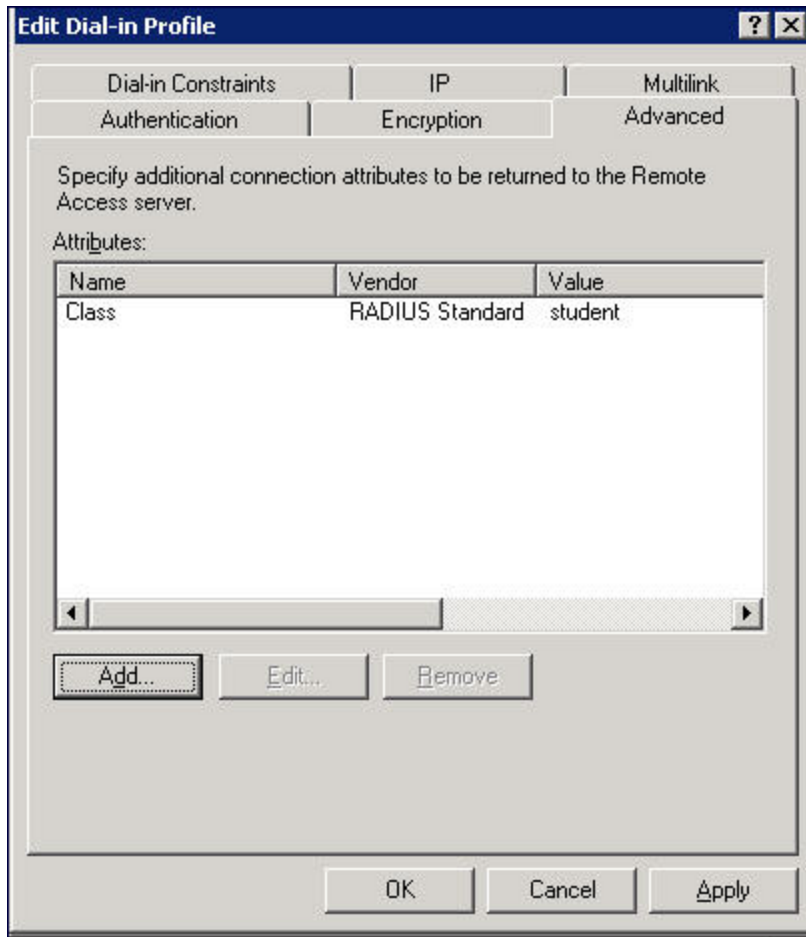

Configuring Management Authentication using IAS

Before you can configure the controller for management authentication using Windows IAS, you must perform the following steps to configure a Windows IAS RADIUS server on your Windows client.



NOTE: The steps to perform this task may vary depending on the version of Windows currently running on your server. For complete details on configuring Windows IAS, refer to the Windows documentation available at www.microsoft.com/downloads.

1. From your windows server, navigate to **Start > Settings > Control Panel > Administrative Tools>Internet Authentication Service**. The **Internet Authentication Service** window opens.
2. Verify that the Internet Authentication Service is running. If it is running, a green arrow icon will appear at the top of this window. If it has stopped, a red stop icon will appear. If the service is not active, click the green arrow icon to restart the service.
3. From the **Internet Authentication Service** window, right click the **Radius Clients** folder and select **New Radius Client**. The **New RADIUS Client** window opens.
4. Define a friendly name for the RADIUS client and enter the controller’s IP address or DNS name. Click **Next**.
5. Enter and confirm the Shared Secret key for the controller then click **Finish**.

Creating a Remote Policy

Next, create a remote policy for your new RADIUS client.

1. From the **Internet Authentication Service** window, right click the **Remote Access Policies** folder and select **New Remote Access Policy**.
2. The **New Remote Access Policy Wizard** opens. Click **Next** on the first window to start the wizard.
3. Select **Use the wizard to set up a typical Policy for a common scenario** and enter a name for the policy, e.g Remote-Policy. Click **Next**.
4. In the **Access Method** window of the wizard, select the method you will use to gain management access to the network. Click **Next**.
5. In the **User or Group Access** window of the wizard, select either **user** or **group**, depending upon how your user permissions are defined. Click **Next**.
6. In the **Authentication Method** window, click the **Type** drop-down list and select **Protected EAP (PEAP)**. Click **Next**.
7. Click **Finish**.

Defining Properties for Remote Policy

Now you must define properties for the remote policy you just created.

1. In the **Internet Authentication Service** window, click the **Remote Access Policy** icon. All configured remote access policies will appear in the right window pane.
2. Right-click the policy you just created, and select **Properties**. The **Properties** window opens.
3. Select the **Grant remote access permission** radio button, and click **Edit Profile**. The **Edit Profile** window opens.
4. Click the **Authentication** tab and select the authentication methods that include **MS-CHAP**, **MS-CHAP V2** and **PAP**.
5. Click **Apply**.
6. Click the **Advanced** tab.
7. Click **Add**. The **Add Attribute** window opens.
8. Scroll down the list of attributes and select **Vendor-Specific**, then click **Add**. The **MultiValued Attribute Information** window appears.
9. Click **Add** again.
10. Enter the vendor code **14823** and select the option **Yes, It conforms**.
11. Click **Configure Attribute**. The **Configure VSA** window opens.
12. In the **Vendor-assigned attribute number** field, enter **3**.
13. In the **Attribute value** field, enter **7**.
14. Click **OK** to save your settings.
15. Click **Apply**.
16. Click **Apply**.

Creating a User Entry in Windows Active Directory

Now that you have defined your remote policy properties, you must create a user entry in the Windows active directory. The steps to complete this process will vary, depending on the version of Windows currently running on your server. The procedure below should be used only as a guideline.

1. Open the “Active Directory Users and Computers” tool on your Windows server.
2. Create a new user entry on the Windows Active directory.
3. Once you have created the new user, right-click the user name and select **Properties**.
4. Click the **Dial-in** tab and select “**Allow access**” for the user.

5. Click **Ok** to save your settings.

Configure the Controller to use IAS Management Authentication

The following procedure describes the steps to configure the controller to user IAS management authentication.

1. Access the controller WebUI and navigate to **Configuration > Authentication**.
2. Select the **Servers** tab.
3. Select **RADIUS** Server.
4. Enter a name for the RADIUS server in the entry field in the right window pane, then click **Add**.
5. Select the RADIUS server you just created from the list of servers in the left window pane to display configuration details for that server.

Figure 414: Configuring a RADIUS Server for IAS Management Authentication

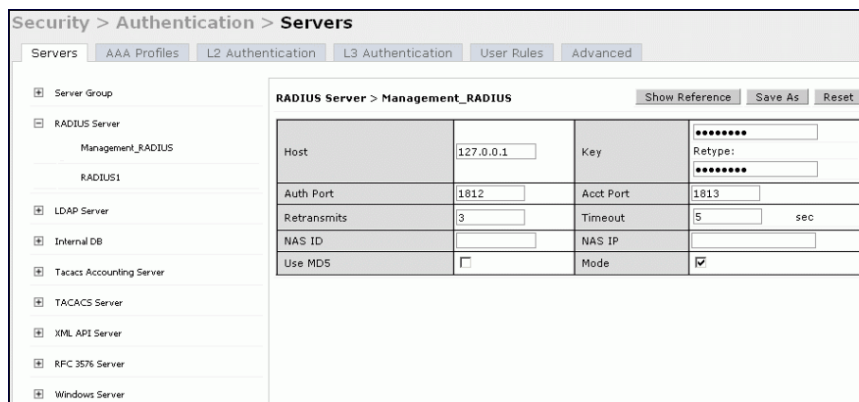

6. In the **Host** field, enter the IP address of the RADIUS server you want to use for Management Authentication.
7. Enter and then retype the shared key for the server.
8. Click **Apply**
9. Select **Server Group** from the server list on the left window pane.
10. In the entry blank on the right window pane, enter the name of a new server group (for example, “Management_group”), then click **Add**.
11. Click **Apply**.
12. Select the server group you just created from the list of server groups in the left window pane.
13. In the **Servers** section, click **New**.
14. Click the **Server Name** drop-down list and select your RADIUS server.

Figure 415: Configuring a Server Group for IAS Management Authentication

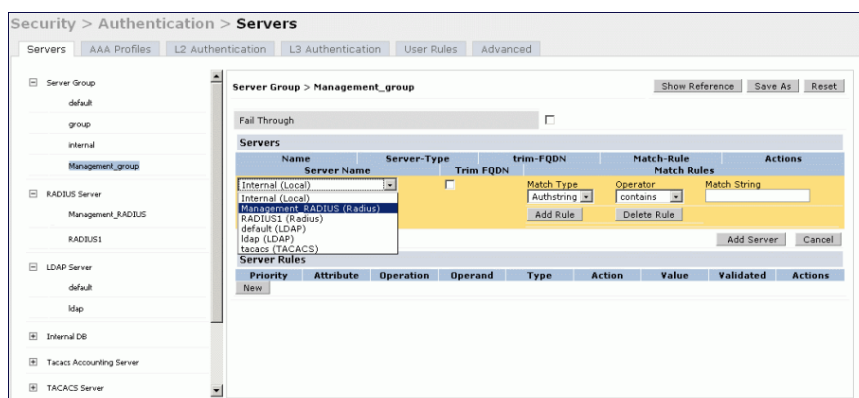

15. Click **Apply**.

Verify Communication between the Controller and the RADIUS Server

After you have configured your Windows Server and the Dell controller for Windows IAS Management Authentication, you can verify that the controller and server are communicating.

1. Navigate to **Diagnostics>AAA Test Server**.
2. Click the **Server Name** drop-down list and select the RADIUS server.
3. Select either **MSCHAP-V2** or **PAP** as the authentication method.
4. Enter the user name and password in the **Username** and **Password** fields.
5. Click **Begin Test**.
6. If the controller displays the words **Authentication Successful**, then the controller is able to communicate with the RADIUS server.

Figure 416: Testing a RADIUS Server

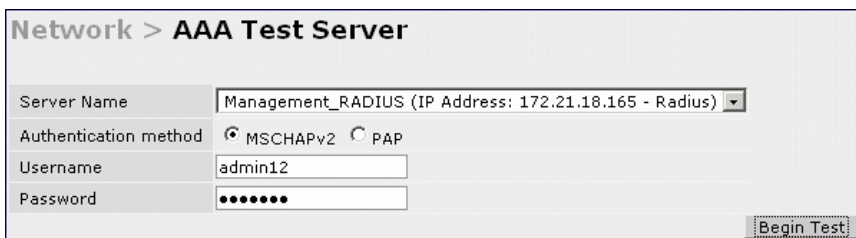

The screenshot shows a configuration window titled "Network > AAA Test Server". It contains the following fields and controls:

- Server Name:** A dropdown menu showing "Management_RADIUS (IP Address: 172.21.18.165 - Radius)".
- Authentication method:** Two radio buttons, with "MSCHAPv2" selected and "PAP" unselected.
- Username:** A text input field containing "admin12".
- Password:** A text input field with masked characters (dots).
- Begin Test:** A button located at the bottom right of the form.

Window XP Wireless Client Sample Configuration

This section shows an example of how to configure a Windows XP wireless client using Windows XP's Wireless Zero Configuration service.



NOTE: The following steps apply to a computer running Windows XP Professional Version 2002 with Service Pack 2. To configure a wireless client on other Windows platforms, see your Microsoft Windows documentation.

1. On the desktop, right-click **My Network Places** and select **Properties**.
2. In the **Network Connections** window, right-click on **Wireless Network Connection** and select **Properties**.
3. Select the **Wireless Networks** tab. This screen displays the available wireless networks and the list of preferred networks. Windows connects to the preferred networks in the order in which they appear in the list.

Figure 417: Wireless Networks

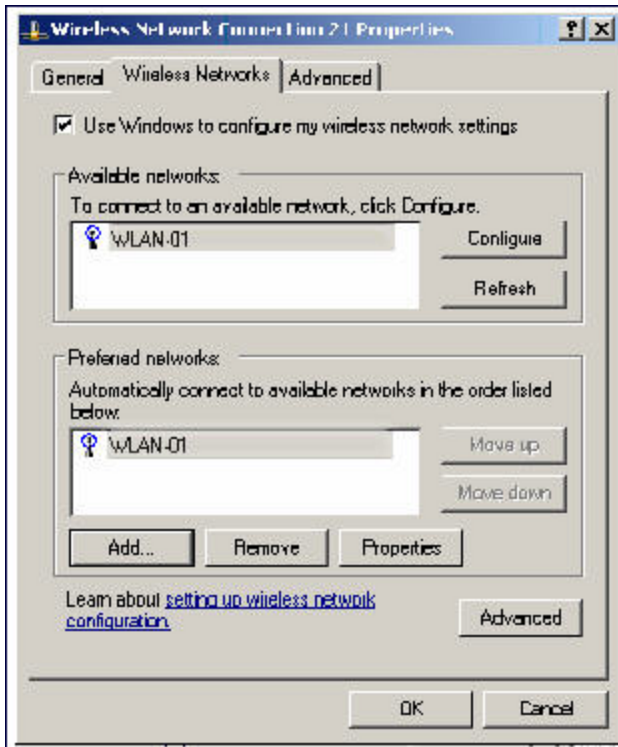

4. Click the **Advanced** button to display the Networks to access window.

Figure 418: Networks to Access

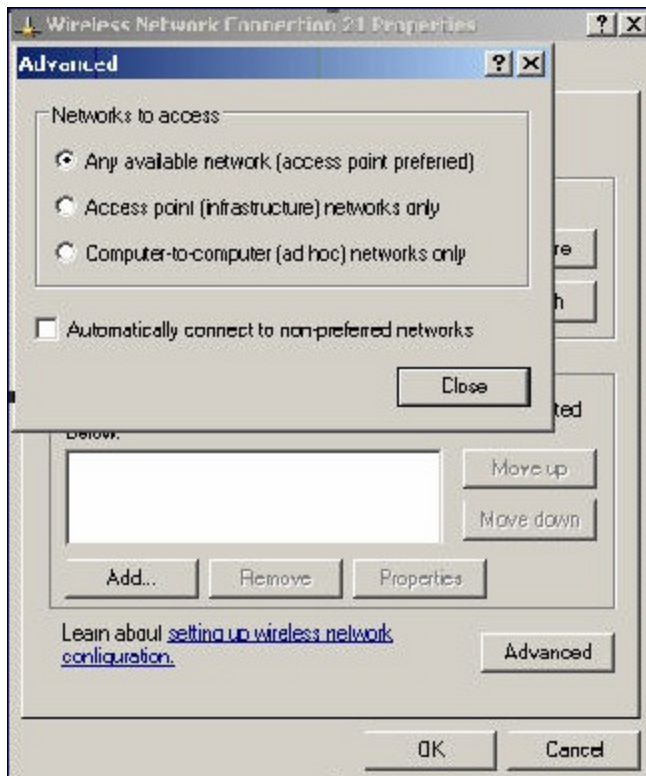

This window determines what types of wireless networks the client can access. By default, Windows connects to any type of wireless network. Make sure that the option *Computer-to-computer (ad hoc) networks only* is *not* selected. Click **Close**.

5. In the **Wireless Networks** tab, click **Add** to add a wireless network.
6. Click the **Association** tab to enter the network properties for the SSID.



NOTE: This tab configures the authentication and encryption used between the wireless client and the Dell user-centric network. Therefore, the settings for the SSID that you configure on the client must *match* the configuration for the SSID on the controller.

- For an SSID using dynamic WEP, enter the following:
 - Network Authentication: Open
 - Data Encryption: WEP
 - Select the option “The key is provided for me automatically”. Each client will use a dynamically-generated WEP key that is automatically derived during the 802.1x process.
- For an SSID using WPA, enter the following:
 - Network Authentication: WPA
 - Data Encryption: TKIP
- For an SSID using WPA-PSK, enter the following:
 - Network Authentication: WPA-PSK
 - Data Encryption: TKIP
 - Enter the pre-shared key.
- For an SSID using WPA2, enter the following:

- Network Authentication: WPA2
- Data Encryption: AES
- For an SSID using WPA2-PSK, enter the following:
 - Network Authentication: WPA2-PSK
 - Data Encryption: AES
 - Enter the pre-shared key



NOTE: Do *not* select the option “This is a computer-to-computer (ad hoc) network; wireless access points are not used”.

Figure 419 shows the configuration for the SSID WLAN-01 which uses WPA network authentication with TKIP data encryption.

Figure 419: Wireless Network Association

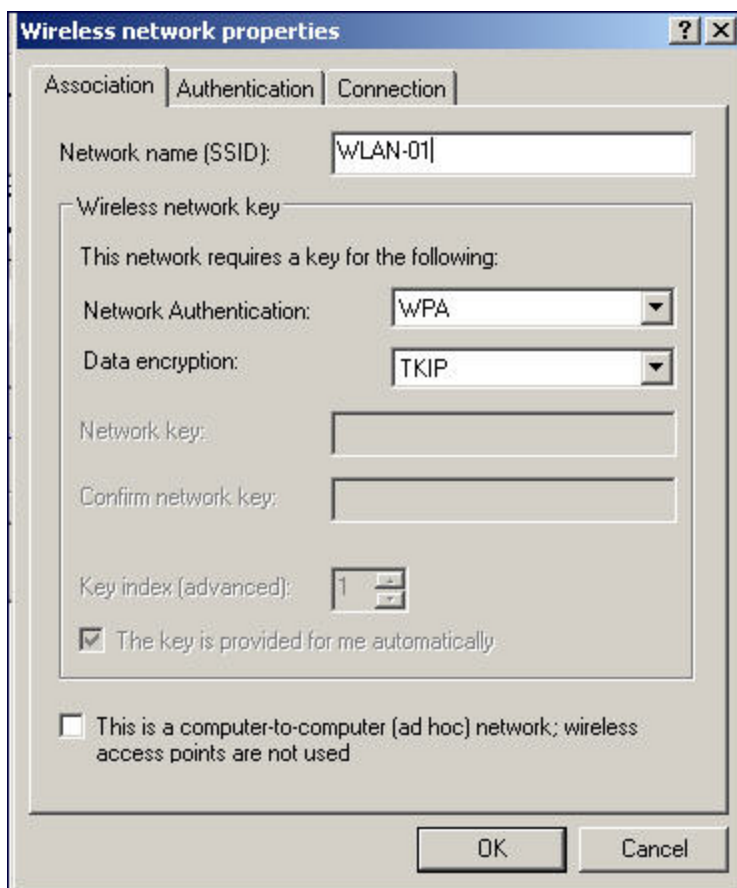

7. Click the **Authentication** tab to enter the 802.1x authentication parameters for the SSID. This tab configures the EAP type used between the wireless client and the authentication server.

Configure the following, as shown in Figure 420:

- Select Enable IEEE 802.1x authentication for this network.
- Select Protected EAP (PEAP) for the EAP type.
- Select Authenticate as computer when computer information is available. The client will perform computer authentication when a user is not logged in.

- Do not select Authenticate as guest when user or computer information is unavailable. The client will not attempt to authenticate as a guest.

Figure 420: Wireless Network Authentication

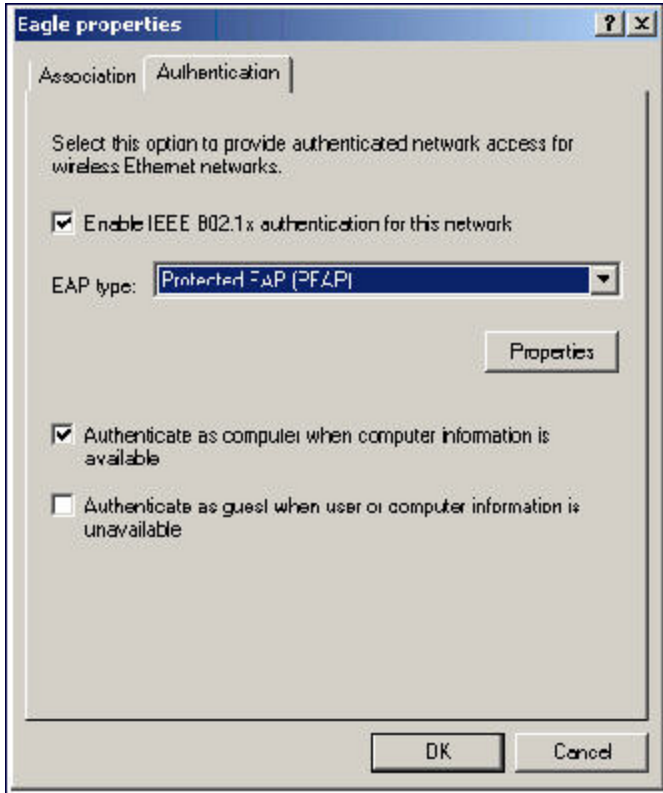

8. Under EAP type, select **Properties** to display the Protected EAP Properties window. Configure the client PEAP properties, as shown in [Figure 421](#):
 - Select Validate server certificate. This instructs the client to check the validity of the server certificate from an expiration, identity, and trust perspective.
 - Select the trusted Certification Authority (CA) that can issue server certificates for the network.
 - Select Secured password (EAP-MSCHAP v2) — the PEAP “inner authentication” mechanism will be an MS-CHAPv2 password.
 - Select Enable Fast Reconnect to speed up authentication in some cases.

Figure 421: Protected EAP Properties

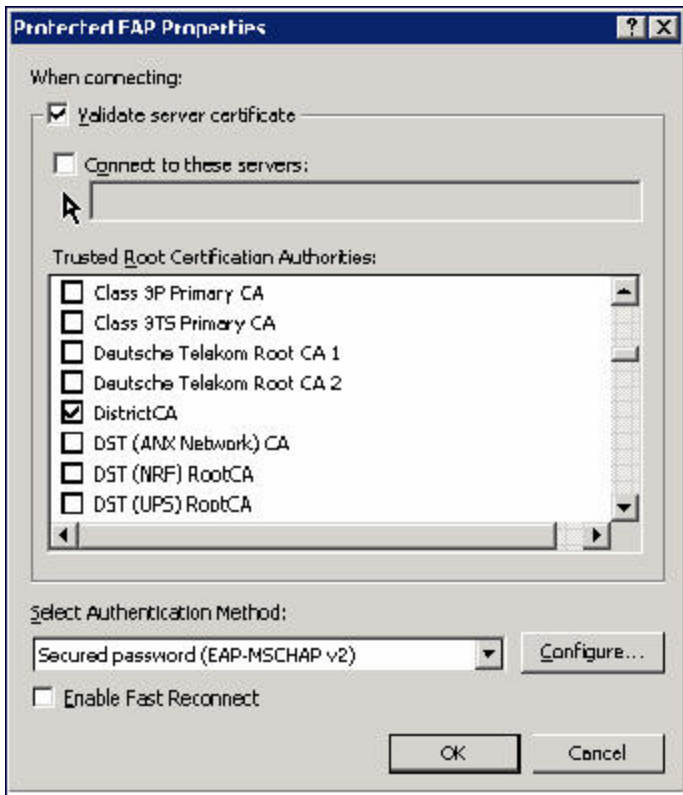

9. Under Select Authentication Method, click **Configure** to display the EAP-MSCHAPv2 Properties window. Select the option Automatically use my Windows logon name and password (and domain if any). This option specifies that the user's Windows logon information is used for authentication to the wireless network. This option allows the same logon credentials to be used for access to the Windows domain as well as the wireless network.

Figure 422: EAP MSCHAPv2 Properties

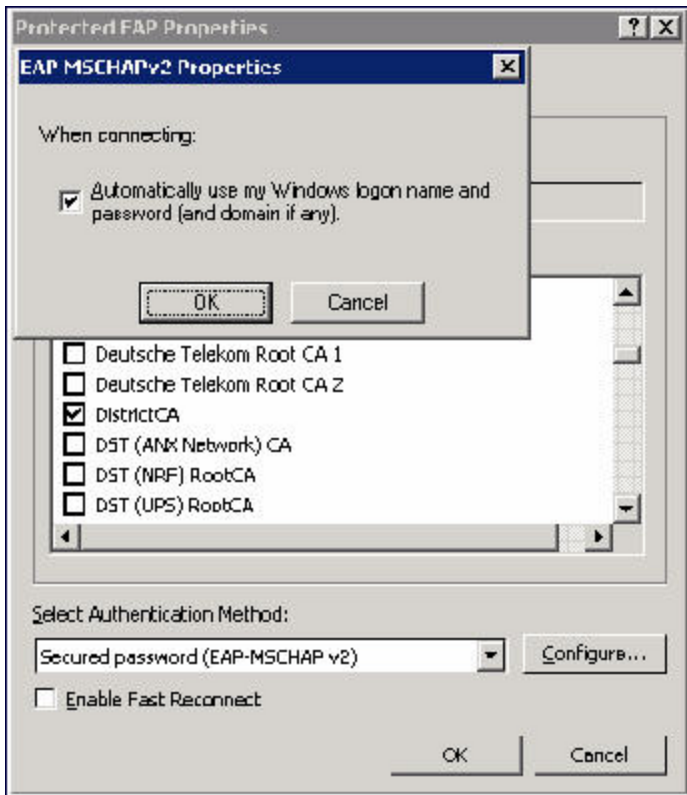

Appendix A

Acronyms and Terms

Acronyms

The following table lists the acronyms and their definitions used in this guide.

Table 423: *List of acronyms*

Acronym	Definition
ABR	area border router
AC	access category
ACI	adjacent channel interference
ACL	access control list
ADP	Aruba Discovery Protocol (ADP)
AES	advanced encryption standard
AIFSN	arbitrary inter-frame space number
ALG	application level gateway
AM	air monitor
AP	access point
APM	AP air monitor
ARM	adaptive radio management
AVF	AntiVirus Firewall
A-MSDU	aggregate MAC service data unit
BCMC	broadcast and multicast
BRAS	broadband remote access server
BRE	basic regular expression
BPDU	bridge protocol data unit
BSSID	basic service set identifier
CA	certification authority

Acronym	Definition
CAC	call admission control
CAP	campus AP
CCA	clear channel assessment
CDP	Cisco Discovery Protocol
CDR	call detail records
CHAP	Challenge Handshake Authentication Protocol
CRL	certificate revocation list
CSA	channel switch announcement
CSMA/CA	carrier sense multiple access with collision avoidance
CSR	certificate signing request
CTS	clear to send
CW	contention window
DAS	distributed antenna systems
DCF	distributed coordination function
DES	data encryption standard
DHCP	Dynamic Host Configuration Protocol
DS	differentiated services
DSCP	differentiated services codepoint
DSSS	direct sequence spread spectrum
DNS	domain name system
DoS	denial of service
DPD	dead peer detection
DR	designated router
DU	data unit
DMO	dynamic multicast optimization
EAP	Extensible Authentication Protocol
EAP-TLS	EAP-transport layer security

Acronym	Definition
EDCA	enhanced distributed channel access
EIRP	effective isotropic radiated power
ESI	external service interfaces
ESS	extended service set
ESSID	extended service set identifier
FE	fast ethernet
FFT	fast fourier transform
FHSS	frequency-hopping spread spectrum
FIB	forwarding information base
FRER	frame receive error rate
FRR	frame retry rate
FSPL	free space path loss
FTP	File Transfer Protocol
FQLN	fully qualified location name
GRE	generic routing encapsulation
GIS	generic interface specification
GMT	Greenwich Mean Time
GPP	guest provisioning page
HMD	high mobility device
HSPA	high-speed packet access
HT	high throughput
IAS	internet authentication server
IDS	intrusion detection system
IE	information element
IEEE	Institute of Electrical and Electronics Engineer
IGMP	Internet Group Management Protocol
IGP	Interior Gateway Routing Protocol

Acronym	Definition
IKE PSK	internet key exchange pre-shared key
ISAKMP	Internet Security Association and Key Management Protocol
LACP	Link Aggregation Control Protocol
LAG	link aggregation group
LD	local debug
LDAP	Lightweight Directory Access Protocol
LEAP	Lightweight Extensible Authentication Protocol
LI	listening interval
L2TP	Layer-2 Tunneling Protocol
MAC	media access control
MCS	modulation and coding scheme
MDPU	MAC protocol data unit
MIB	management information base
MIMO	multiple input, multiple output
MMS	mobility management system
MP	mesh point
MPP	mesh portal
MPV	mesh private VLAN
MSCHAP	Microsoft Challenge Handshake Authentication Protocol
MSCHAPv2	MSCHAP version 2
MSSID	mesh service set identifier
MPPE	Microsoft point-to-point encryption
MTU	maximum transmission unit
NAS	network access server
NAT	network address translation
NIC	network interface card
NOE	new office environment

Acronym	Definition
NTP	Network Time Protocol
OCSP	Online Certificate Status Protocol
OFDM	orthogonal frequency division multiplexing
OKC	opportunistic key caching
OSPF	open shortest path first
OUI	organizationally unique identifier
PAC	protected access credential
PAP	Password Authentication Protocol
PAPI	proprietary access protocol interface
PFS	perfect forward secrecy
PHB	per hop behavior
PIN	personal identification number
PKI	public key infrastructure
PMK	pairwise master key
PoE	power over ethernet
PSK	pre-shared key
PPPoE	point-to-point protocol over ethernet
PPTP	Point-to-Point Tunneling Protocol
PVST	per VLAN spanning tree
QoS	quality of service
RADIUS	remote authentication dial-in user service
RAP	remote AP
REGEX	region with the regular expression
RF	radio frequency
RFID	radio frequency identification
RoW	rest of world
RSSI	received signal strength indication

Acronym	Definition
RSTP	Rapid Spanning Tree Protocol
RTLS	real-time locating systems
RTS	request to send
SA	security association
SDR	software-defined radio
SIM	subscriber identity module
SIP	Session Initiation Protocol
SNIR	signal-to-noise-and-interference ratio
SNMP	Simple Network Management Protocol
SSID	service set identifier
STP	Spanning Tree Protocol
STRAP	secure thin remote access point
SVP	spectralink voice priority
TFTP	Trivial File Transfer Protocol
TIM	traffic indication map
TLS	transport layer security
TOS	type of service
TPM	trusted platform module
TSPEC	traffic specification
TXOP	opportunity to transmit
UDP	User Datagram Protocol
UTMS	universal mobile telecommunication systems
U-APSD	unscheduled automatic power save delivery
VBA	virtual branch networking
VIA	virtual intranet access
VoFI	voice over Wi-Fi
VoIP	voice over IP

Acronym	Definition
VPN	virtual private network
VRD	validated reference design
VRRP	Virtual Router Redundancy Protocol
VSA	vendor specific attributes
VTP	Virtual Trunking Protocol
WIDS	wireless intrusion detection system
WINS	windows internet naming service
WIPS	wireless intrusion prevention system
WISPr	wireless internet service provider roaming
WLAN	wireless local area network
WMM	wireless multimedia
WMS	WLAN management system
WSIRT	wireless security incident response team
WZC	wireless zero config
XAuth	extended authentication

Terms

The following table lists the terms and their definitions used in this guide.

Table 424: *List of terms*

Term	Definition
802.11	An evolving family of specifications for wireless LANs developed by a working group of the Institute of Electrical and Electronics Engineers (IEEE). 802.11 standards use the Ethernet protocol and CSMA/CA (carrier sense multiple access with collision avoidance) for path sharing.
802.11a	Provides specifications for wireless systems. Networks using 802.11a operate at radio frequencies in the 5GHz band. The specification uses a modulation scheme known as orthogonal frequency-division multiplexing (OFDM) that is especially well suited to use in office settings.
802.11b	WLAN standard often called Wi-Fi; backward compatible with 802.11. Instead of the phase-shift keying (PSK) modulation method historically used in 802.11 standards, 802.11b uses complementary code keying (CCK), which allows higher data speeds and is less susceptible to multipath-propagation interference.
802.11d	A wireless network communications specification for use in countries where systems using other standards in the 802.11 family are not allowed to operate.

Term	Definition
	Configuration can be fine-tuned at the Media Access Control layer (MAC layer) level to comply with the rules of the country or district in which the network is to be used. Rules subject to variation include allowed frequencies, allowed power levels, and allowed signal bandwidth. 802.11d facilitates global roaming.
802.11e	A proposed adaptation to the 802.11a and 802.11b specifications that enhances the 802.11 Media Access Control layer (MAC layer) with a coordinated time division multiple access (TDMA) construct, and adds error-correcting mechanisms for delay-sensitive applications such as voice and video. The 802.11e specification provides seamless interoperability between business, home, and public environments such as airports and hotels and offers all subscribers high-speed Internet access with full-motion video, high-fidelity audio, and Voice over IP (VoIP).
802.11g	Offers transmission over relatively short distances at up to 54 megabits per second (Mbps), compared with the 11 Mbps theoretical maximum of 802.11b. 802.11g employs orthogonal frequency division multiplexing (OFDM), the modulation scheme used in 802.11a, to obtain higher data speed. Computers or terminals set up for 802.11g can fall back to speeds of 11 Mbps, so that 802.11b and 802.11g devices can be compatible within a single network.
802.11h	Intended to resolve interference issues introduced by the use of 802.11a in some locations, particularly with military radar systems and medical devices. Dynamic frequency selection (DFS) detects the presence of other devices on a channel and automatically switches the network to another channel if and when such signals are detected. Transmit power control (TPC) reduces the radio-frequency (RF) output power of each network transmitter to a level that minimizes the risk of interference.
802.11i	Provides improved encryption for networks that use 802.11a, 802.11b, and 802.11g standards. Requires new encryption key protocols, known as Temporal Key Integrity Protocol (TKIP) and Advanced Encryption Standard (AES). Other features include key caching, which facilitates fast reconnection to the server for users who have temporarily gone offline, and pre-authentication, which allows fast roaming and is ideal for use with advanced applications such as Voice over Internet Protocol (VoIP).
802.11j	Proposed addition to the 802.11 family of standards that incorporates Japanese regulatory extensions to 802.11a; the main intent is to add channels in the radio-frequency (RF) band of 4.9 GHz to 5.0 GHz. WLANs using 802.11j will provide for speeds of up to 54 Mbps, and will employ orthogonal frequency division multiplexing (OFDM). The specification will define how Japanese 802.11 family WLANs and other wireless systems, particularly HiperLAN2 networks, can operate in geographic proximity without mutual interference.
802.11k	Proposed standard for how a WLAN should perform channel selection, roaming, and transmit power control (TPC) in order to optimize network performance. In a network conforming to 802.11k, if the access point (AP) having the strongest signal is loaded to capacity, a wireless device is connected to one of the underutilized APs. Even though the signal may be weaker, the overall throughput is greater because more efficient use is made of the network resources.
802.11n	Wireless networking standard to improve network throughput over the two previous standards 802.11a and 802.11g with a significant increase in the maximum raw data rate from 54 Mbit/s to 600 Mbit/s with the use of four spatial streams at a channel width of 40 MHz.
802.11m	An initiative to perform editorial maintenance, corrections, improvements,

Term	Definition
802.11 bSec	<p>The bSec protocol is a pre-standard protocol that has been proposed to the IEEE 802.11 committee as an alternative to 802.11i. The difference between bSec and standard 802.11i is that bSec implements Suite B algorithms whenever possible. Notably, AES-CCM is replaced by AES-CGM, and the Key Derivation Function (KDF) of 802.11i is upgraded to support SHA-256 and SHA-384.</p> <p>In order to provide interoperability with standard Wi-Fi software drivers, bSec is implemented as a shim layer between standard 802.11 Wi-Fi and a Layer 3 protocol such as IP. A controller configured to advertise a bSec SSID will advertise an open network, however only bSec frames will be permitted on the network.</p>
802.1X	<p>Standard designed to enhance 802.11 WLAN security. 802.1X provides an authentication framework, allowing a user to be authenticated by a central authority. The actual algorithm that is used to determine whether a user is authentic is left open and multiple algorithms are possible.</p>
access point (AP)	<p>An access point connects users to other users within the network and also can serve as the point of interconnection between the WLAN and a fixed wire network. The number of access points a WLAN needs is determined by the number of users and the size of the network.</p>
access point mapping	<p>The act of locating and possibly exploiting connections to WLANs while driving around a city or elsewhere. To do war driving, you need a vehicle, a computer (which can be a laptop), a wireless Ethernet card set to work in promiscuous mode, and some kind of an antenna which can be mounted on top of or positioned inside the car. Because a WLAN may have a range that extends beyond an office building, an outside user may be able to intrude into the network, obtain a free Internet connection, and possibly gain access to company records and other resources.</p>
ad-hoc network	<p>A LAN or other small network, especially one with wireless or temporary plug-in connections, in which some of the network devices are part of the network only for the duration of a communications session or, in the case of mobile or portable devices, while in some close proximity to the rest of the network.</p>
A-MSDU	<p>A structure containing multiple MSDUs, transported within a single (unfragmented) data medium access control (MAC) protocol data unit (MPDU).</p>
band	<p>A specified range of frequencies of electromagnetic radiation.</p>
digital wireless pulse	<p>Wireless technology for transmitting large amounts of digital data over a wide spectrum of frequency bands with very low power for a short distance. Ultra wideband radio can carry a huge amount of data over a distance up to 230 feet at very low power (less than 0.5 milliwatts), and has the ability to carry signals through doors and other obstacles that tend to reflect signals at more limited bandwidths and a higher power.</p>
evil twin	<p>A home-made wireless access point that masquerades as a legitimate one to gather personal or corporate information without the end-user's knowledge. It's fairly easy for an attacker to create an evil twin by simply using a laptop, a wireless card and some readily-available software. The attacker positions himself in the vicinity of a legitimate Wi-Fi access point and lets his computer discover what name and radio frequency the legitimate access point uses. He then sends out his own radio signal, using the same name.</p>
extensible authentication protocol (EAP)	<p>Authentication protocol for wireless networks that expands on methods used by the point-to-point protocol (PPP), a protocol often used when connecting a computer</p>

Term	Definition
	to the Internet. EAP can support multiple authentication mechanisms, such as token cards, smart cards, certificates, one-time passwords, and public key encryption authentication.
fixed wireless	Wireless devices or systems in fixed locations such as homes and offices. Fixed wireless devices usually derive their electrical power from the utility mains, unlike mobile wireless or portable wireless which tend to be battery-powered. Although mobile and portable systems can be used in fixed locations, efficiency and bandwidth are compromised compared with fixed systems.
frequency allocation	Use of radio frequency spectrum regulated by governments.
frequency spectrum	Part of the electromagnetic spectrum.
goodput	<p>Goodput is the ratio of the total bytes transmitted or received in the network to the total air time required for transmitting or receiving the bytes. The air time includes the retransmission time taken for both successful and dropped frames. Suppose 1000 frames of 1500 bytes each are transmitted in the network as follows:</p> <ul style="list-style-type: none"> • 50% of frames are transmitted successfully at MCS index 11 at 108 Mbps. • 25% of the frames were dropped in the 1st attempt at 108 Mbps but were successfully transmitted using MCS index 3 at 54 Mbps in the second attempt. • The remaining 25% are dropped in both the attempts. <p>Then the effective rate is calculated as: The total bits transmitted / the total air time. In this example: $(500 * 1500 + 250 * 1500) * 8 / (\text{total air time for 50\% frames} + \text{total air time for 25\% frames retransmitted} + \text{total air time for 25\% dropped frames}) = 40.5 \text{ Mbps}$.</p>
hot spot	A WLAN node that provides Internet connection and virtual private network (VPN) access from a given location. A business traveller, for example, with a laptop equipped for Wi-Fi can look up a local hot spot, contact it, and get connected through its network to reach the Internet and their own company remotely with a secure connection. Increasingly, public places, such as airports, hotels, and coffee shops are providing free wireless access for customers.
hot zone	A wireless access area created by multiple hot spots located in close proximity to each other. Hot zones usually combine public safety access points with public hot spots. Each hot spot typically provides network access for distances between 100 and 300 feet; various technologies, such as mesh network topologies and fiber optic backbones, are used in conjunction with the hot spots to create areas of coverage.
Infrared Data Association(IrDA)	An industry-sponsored organization set up in 1993 to create international standards for the hardware and software used in infrared communication links. In this special form of radio transmission, a focused ray of light in the infrared frequency spectrum, measured in terahertz, or trillions of hertz (cycles per second), is modulated with information and sent from a transmitter to a receiver over a relatively short distance
IR wireless	The use of wireless technology in devices or systems that convey data through infrared (IR) radiation. Infrared is electromagnetic energy at a wavelength or wavelengths somewhat longer than those of red light. The shortest-wavelength IR borders visible red in the electromagnetic radiation spectrum; the longest-wavelength IR borders radio waves.
microwave	Electromagnetic energy having a frequency higher than 1 gigahertz (billions of cycles per second), corresponding to wavelength shorter than 30 centimeters. Microwave signals propagate in straight lines and are affected very little by the

Term	Definition
	troposphere. They are not refracted or reflected by ionized regions in the upper atmosphere. Microwave beams do not readily diffract around barriers such as hills, mountains, and large human-made structures.
MIMO	An antenna technology for wireless communications in which multiple antennas are used at both the source (transmitter) and the destination (receiver). The antennas at each end of the communications circuit are combined to minimize errors and optimize data speed. MIMO is one of several forms of smart antenna technology, the others being MISO (multiple input, single output) and SIMO (single input, multiple output).
MISO	An antenna technology for wireless communications in which multiple antennas are used at the source (transmitter). The antennas are combined to minimize errors and optimize data speed. The destination (receiver) has only one antenna. MISO is one of several forms of smart antenna technology, the others being MIMO (multiple input, multiple output) and SIMO (single input, multiple output).
near field communication(NFC)	A short-range wireless connectivity standard (Ecma-340, ISO/IEC 18092) that uses magnetic field induction to enable communication between devices when they're touched together, or brought within a few centimeters of each other. The standard specifies a way for the devices to establish a peer-to-peer (P2P) network to exchange data.
optical wireless	The combined use of conventional radio-frequency (RF) wireless and optical fiber for telecommunication. Long-range links are provided by optical fiber and links from the long-range end-points to end users are accomplished by RF wireless or laser systems. RF wireless at ultra-high frequencies (UHF) and microwave frequencies can carry broadband signals to individual computers at substantial data speeds.
OCSP Client	The ArubaOScontroller can act as an OCSP client and issues OCSP queries to remote OCSP responders located on the intranet or Internet.
OCSP Responder	The OCSP client retrieves certificate revocation status from an OCSP responder. The responder may be the certificate authority (CA) that has issued the certificate in question or it may be some other designated entity which provides the service on behalf of the CA.
radio frequency (RF)	Portion of electromagnetic spectrum in which electromagnetic waves are generated by feeding alternating current to an antenna.
RF plan	Dell deployment modeling tool. This tool is provided in the Dell Web-UI as well as the Dell Mobility Management System.
structured wireless-aware network (SWAN)	A technology that incorporates a WLAN into a wired wide-area network (WAN). SWAN technology can enable an existing wired network to serve hundreds of users, organizations, corporations, or agencies over a large geographic area. A SWAN is said to be scalable, secure, and reliable.
transponder	A wireless communications, monitoring, or control device that picks up and automatically responds to an incoming signal. The term is a contraction of the words transmitter and responder. Transponders can be either passive or active.
ultra high frequency (UHF)	International Telecommunication Union (ITU) band 9, 300-3000 MHz, 1m - 100 mm frequency wavelength.
ultra wideband (UWB)	Is a wireless technology for transmitting large amounts of digital data over a wide

Term	Definition
	spectrum of frequency bands with very low power for a short distance. Ultra wideband broadcasts very precisely timed digital pulses on a carrier signal across a very wide spectrum (number of frequency channels) at the same time. UWB can carry a huge amount of data over a distance up to 230 feet at very low power (less than 0.5 milliwatts), and has the ability to carry signals through doors and other obstacles that tend to reflect signals at more limited bandwidths and a higher power.
virtual private network (VPN)	A network that uses a public telecommunication infrastructure, such as the Internet, to provide remote offices or individual users with secure access to their organization's network. A VPN ensures privacy through security procedures and tunneling protocols such as the Layer Two Tunneling Protocol (L2TP). Data is encrypted at the sending end and decrypted at the receiving end.
voice over WLAN (VoWLAN)	A method of routing telephone calls for mobile users over the Internet using the technology specified in IEEE 802.11b. Routing mobile calls over the Internet makes them free, or at least much less expensive than they would be otherwise.
wideband code-division multiple access (W-CDMA)	Officially known as IMT-2000 direct spread; ITU standard derived from Code-Division Multiple Access (CDMA). W-CDMA is a third-generation (3G) mobile wireless technology that promises much higher data speeds to mobile and portable wireless devices than commonly offered in today's market.
Wi-Fi	A term for certain types of WLANs. Wi-Fi can apply to products that use any 802.11 standard. Wi-Fi has gained acceptance in many businesses, agencies, schools, and homes as an alternative to a wired LAN. Many airports, hotels, and fast-food facilities offer public access to Wi-Fi networks.
WiMAX	A wireless industry coalition whose members organized to advance IEEE 802.16 standards for broadband wireless access (BWA) networks. WiMAX 802.16 technology is expected to enable multimedia applications with wireless connection and, with a range of up to 30 miles, enable networks to have a wireless last mile solution. According to the WiMAX forum, the group's aim is to promote and certify compatibility and interoperability of devices based on the 802.16 specification, and to develop such devices for the marketplace.
wired equivalent privacy (WEP)	A security protocol specified in 802.11b, designed to provide a WLAN with a level of security and privacy comparable to what is usually expected of a wired LAN. Data encryption protects the vulnerable wireless link between clients and access points; once this measure has been taken, other typical LAN security mechanisms such as password protection, end-to-end encryption, virtual private networks (VPNs), and authentication can be put in place to ensure privacy.
wireless	Describes telecommunications in which electromagnetic waves (rather than some form of wire) carry the signal over part or all of the communication path.
wireless abstract XML (WAX)	Describes telecommunications in which electromagnetic waves (rather than some form of wire) carry the signal over part or all of the communication path.
wireless application service provider (WASP)	Provides Web-based access to applications and services that would otherwise have to be stored locally and makes it possible for customers to access the service from a variety of wireless devices, such as a smartphone or personal digital assistant (PDA).
wireless ISP (WISP)	An internet service provider (ISP) that allows subscribers to connect to a server at designated hot spots (access points) using a wireless connection such as Wi-Fi. This type of ISP offers broadband service and allows subscriber computers, called

Term	Definition
	stations, to access the Internet and the Web from anywhere within the zone of coverage provided by the server antenna, usually a region with a radius of several kilometers.
wireless service provider	A company that offers transmission services to users of wireless devices through radio frequency (RF) signals rather than through end-to-end wire communication.
wireless local area network (WLAN)	A local area network (LAN) that users access through a wireless connection. 802.11 standards specify WLAN technologies. WLANs are frequently some portion of a wired LAN.
yagi antenna	A unidirectional antenna commonly used in communications when a frequency is above 10 MHz.